



CITY

60418



2

3

4

5

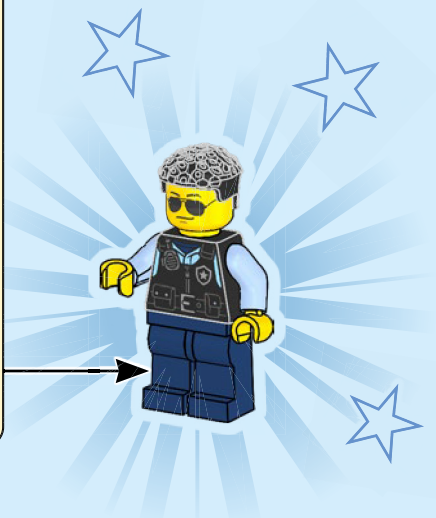
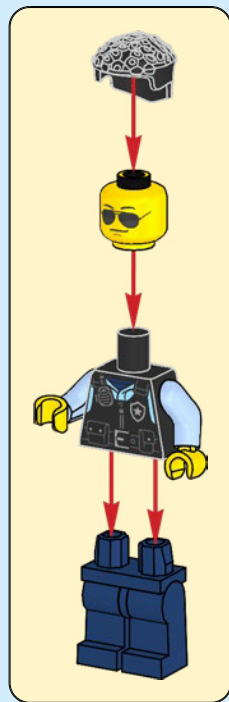

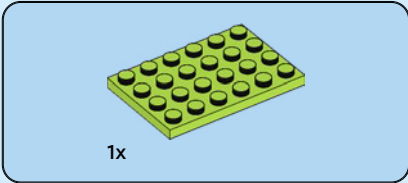
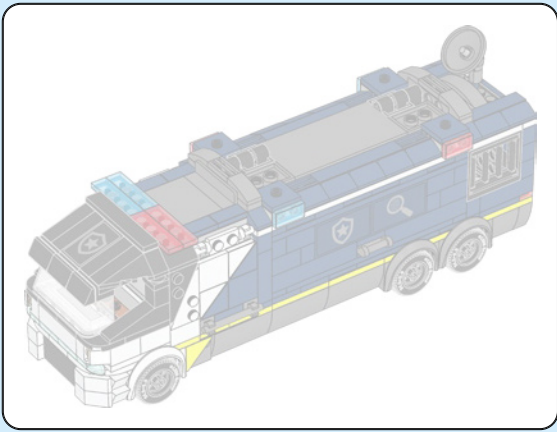

1

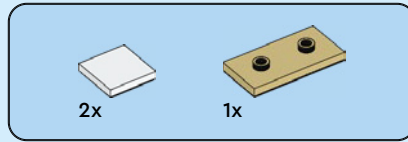
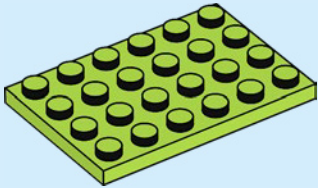

2

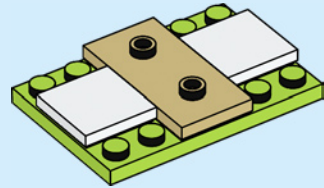

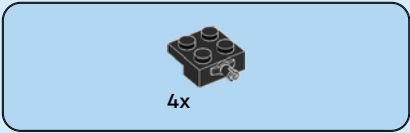

3

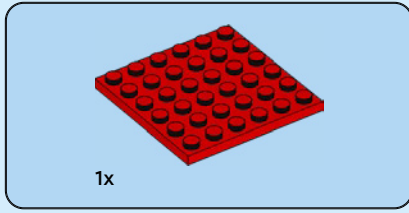
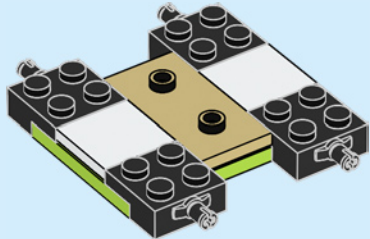

4

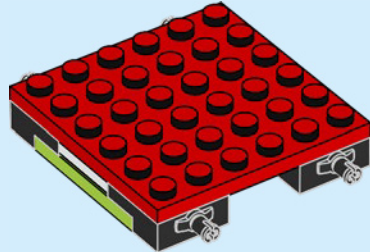

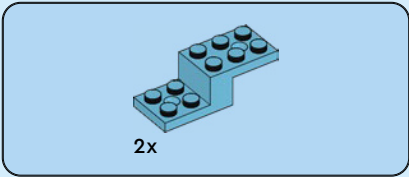

5

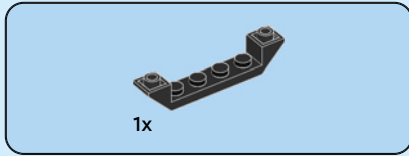
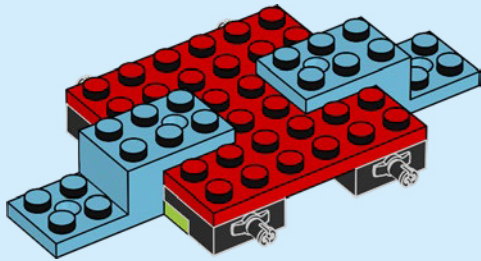

6

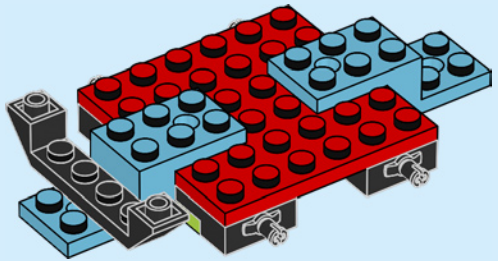

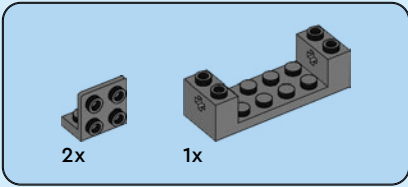

7

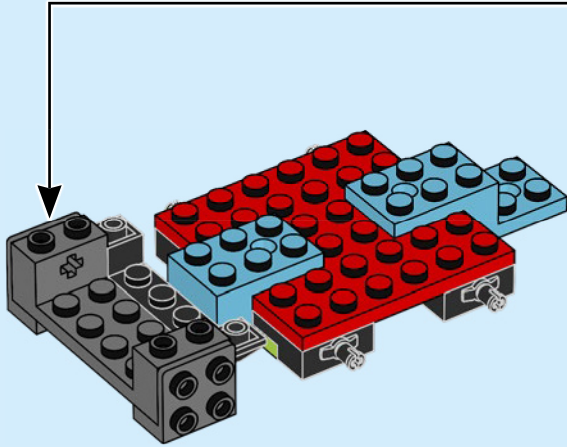
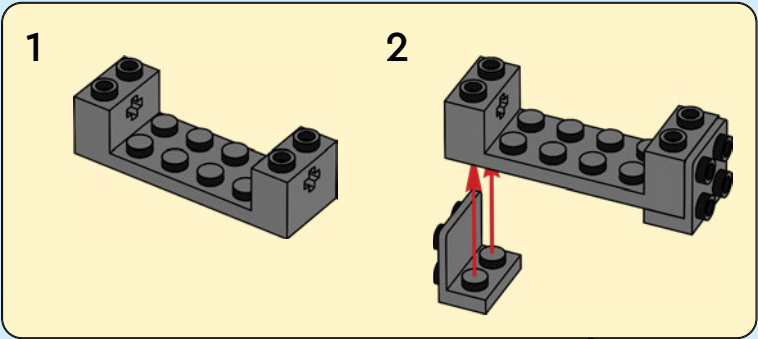

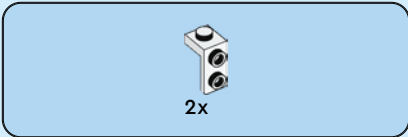

10

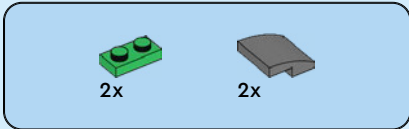
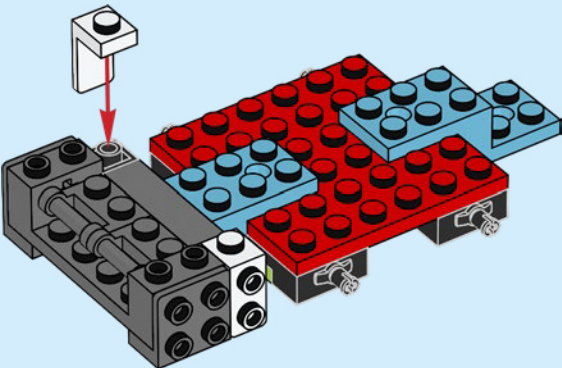

11

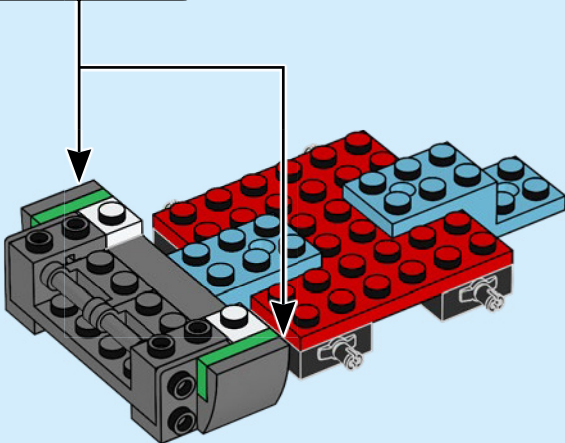
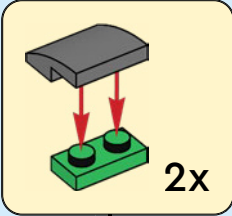



2x



2x

12

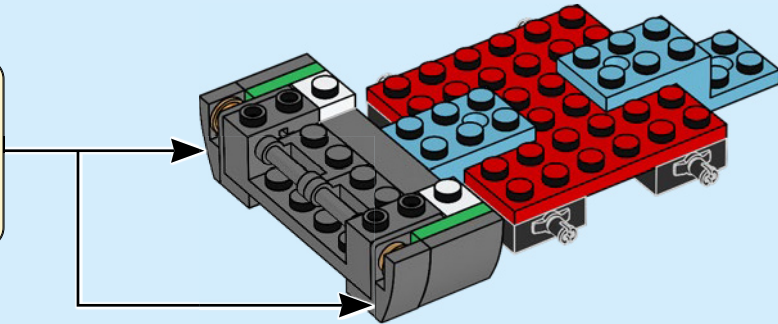
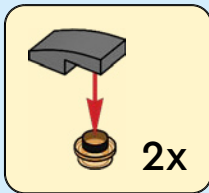

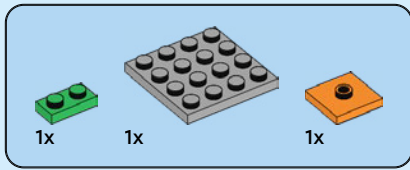

13

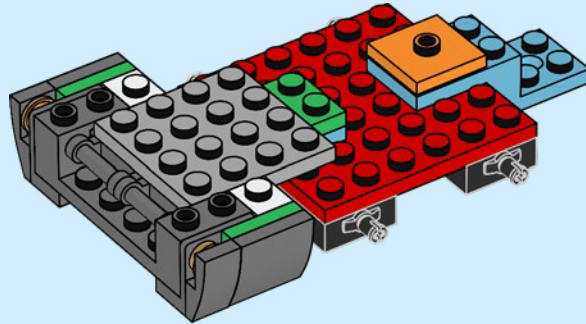

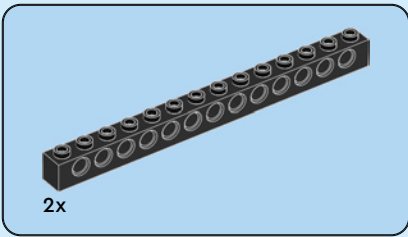

14

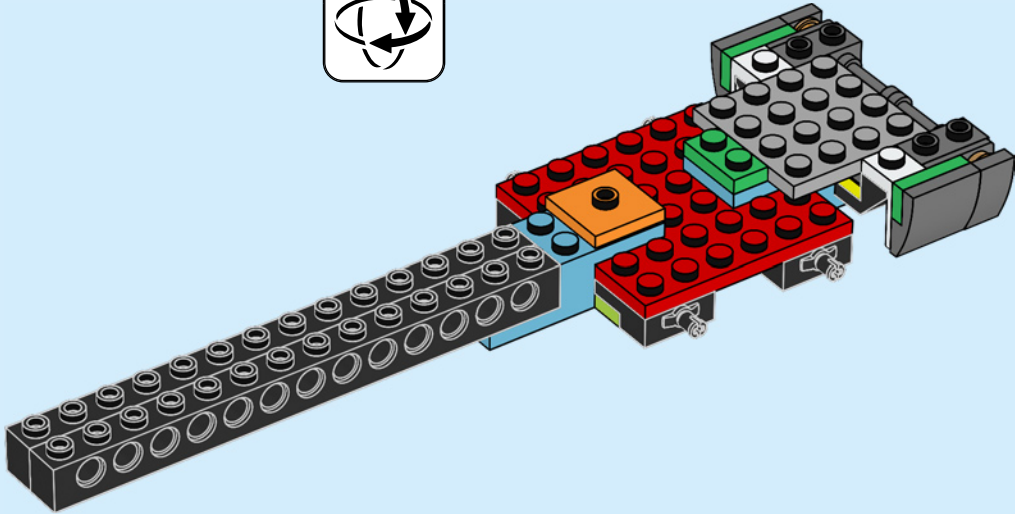

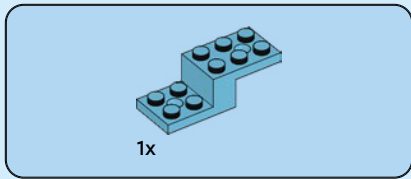

15

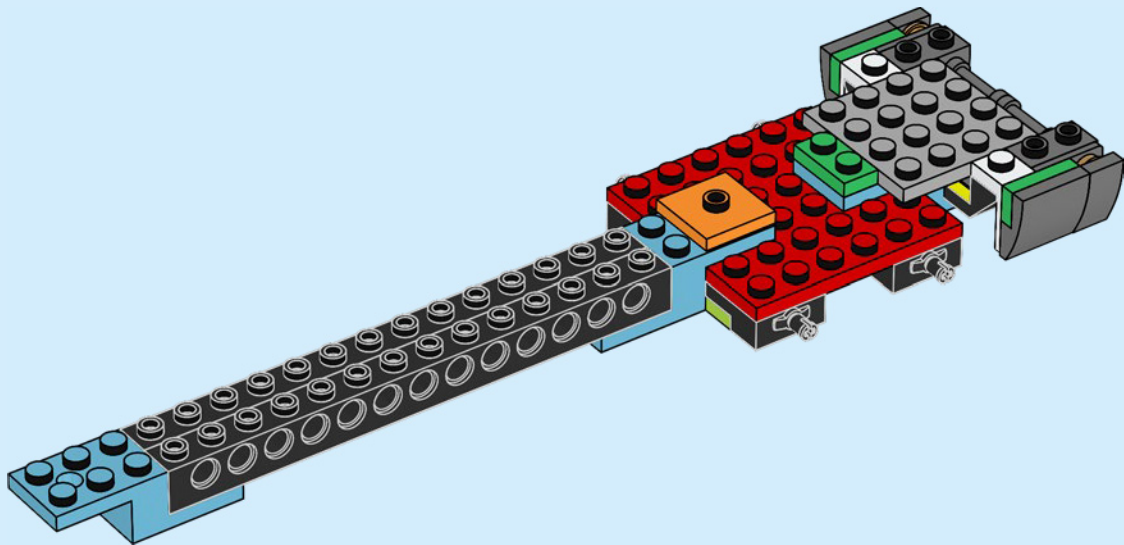

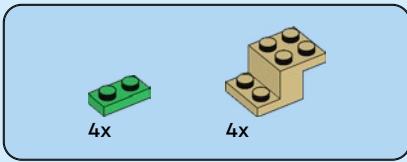

16

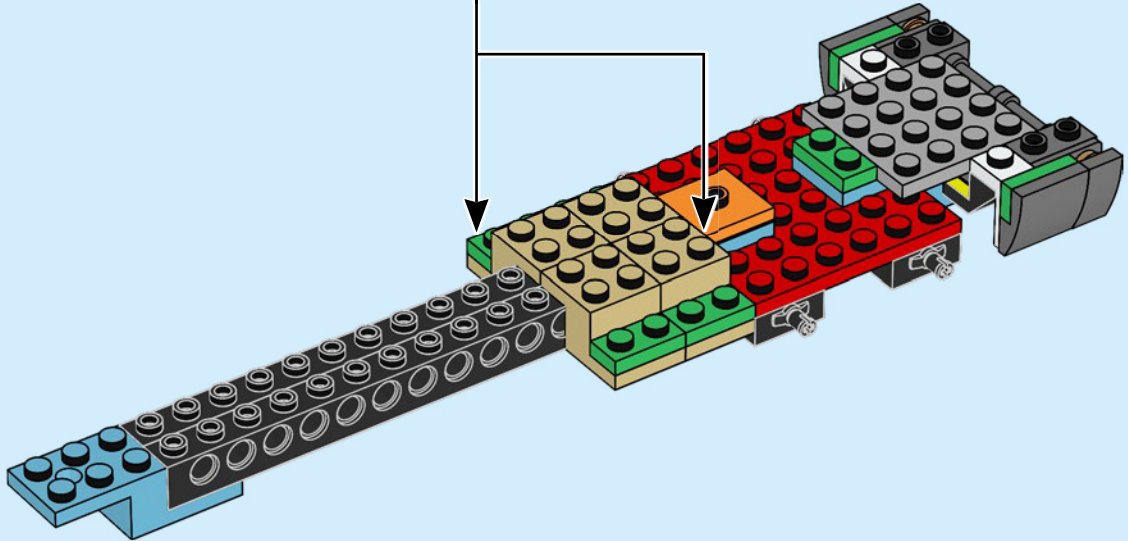
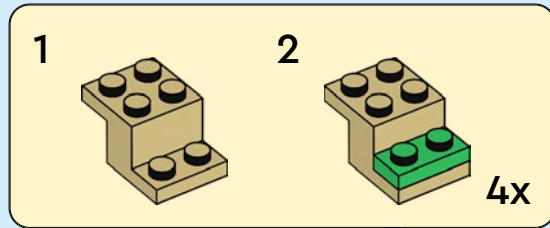

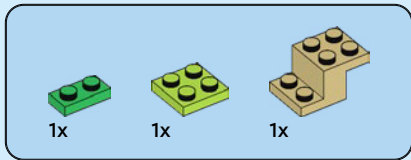

17

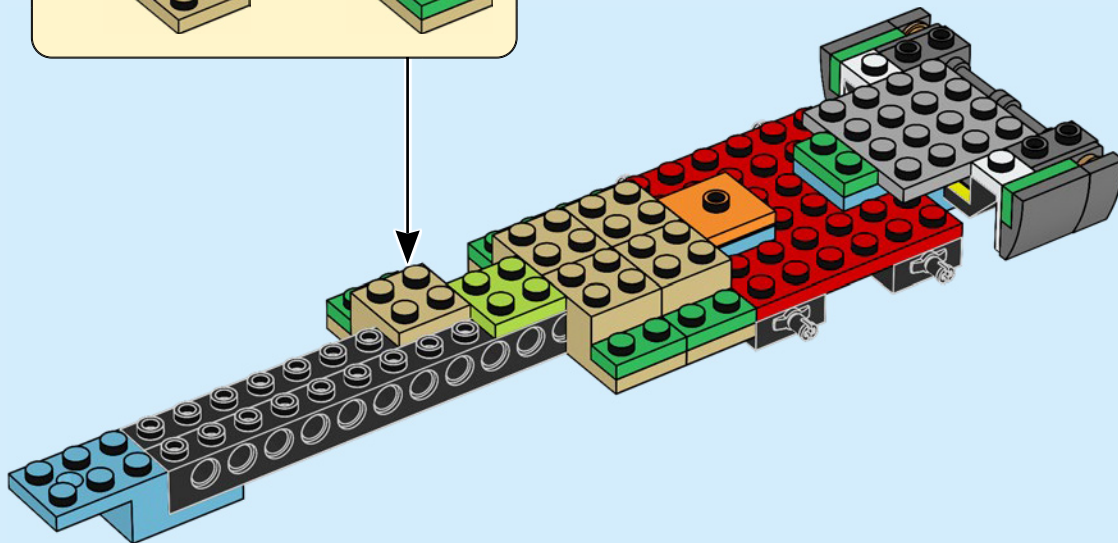
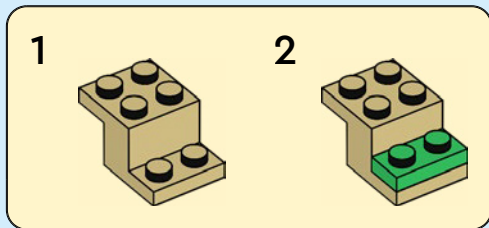

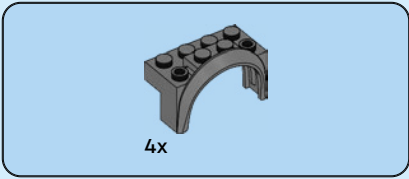

18

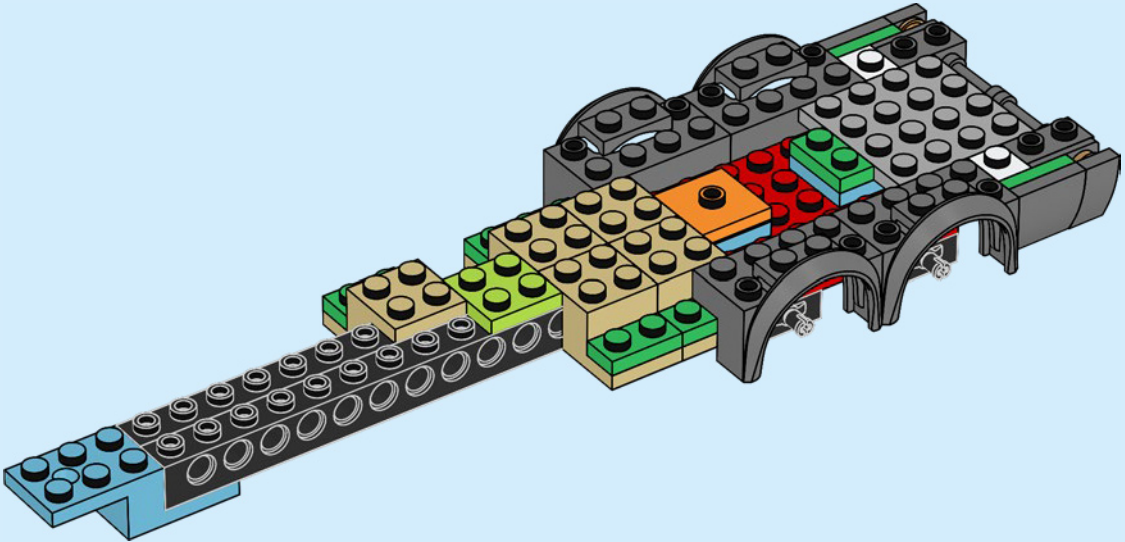

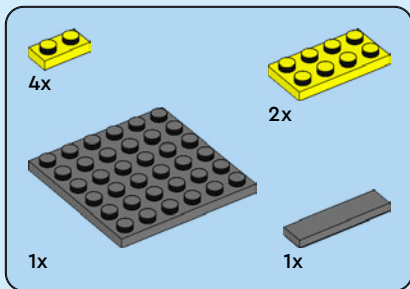

19

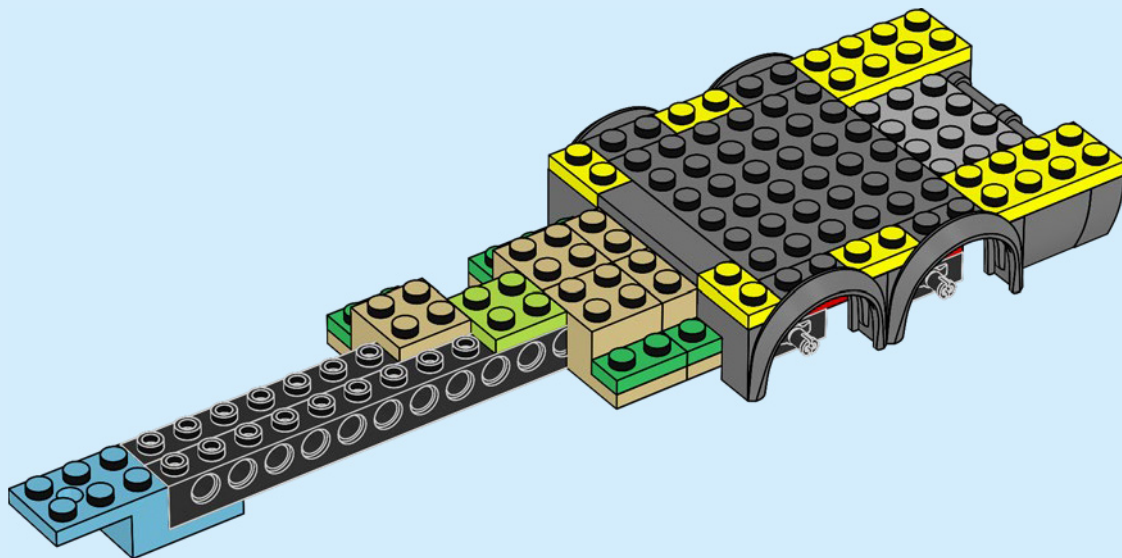

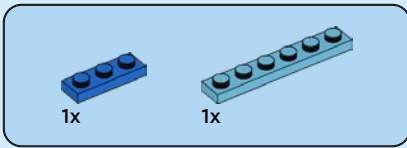

20

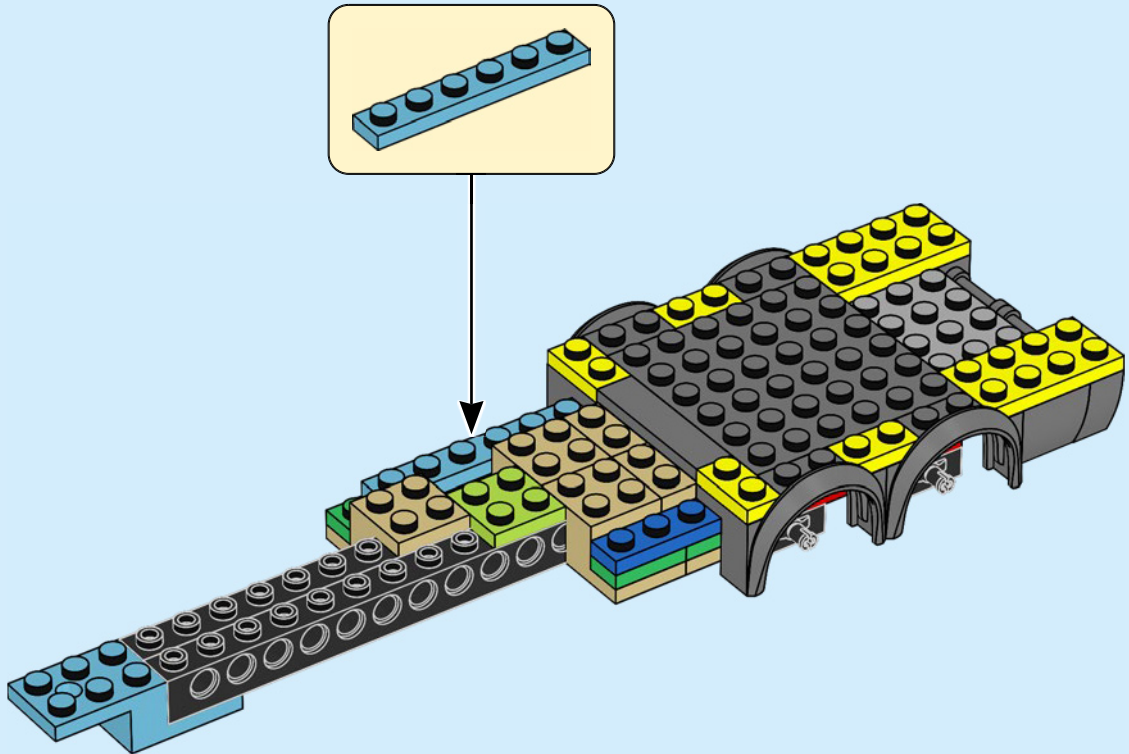

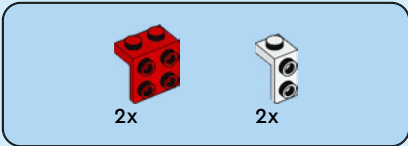

21

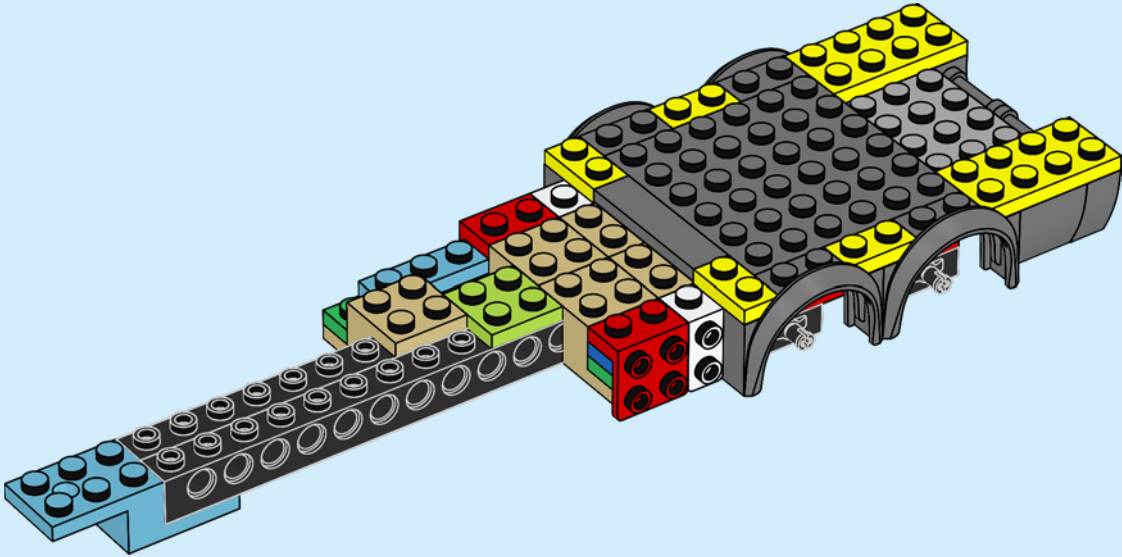

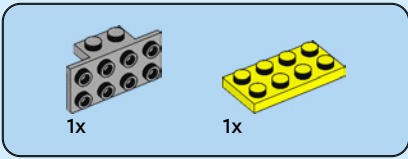

22

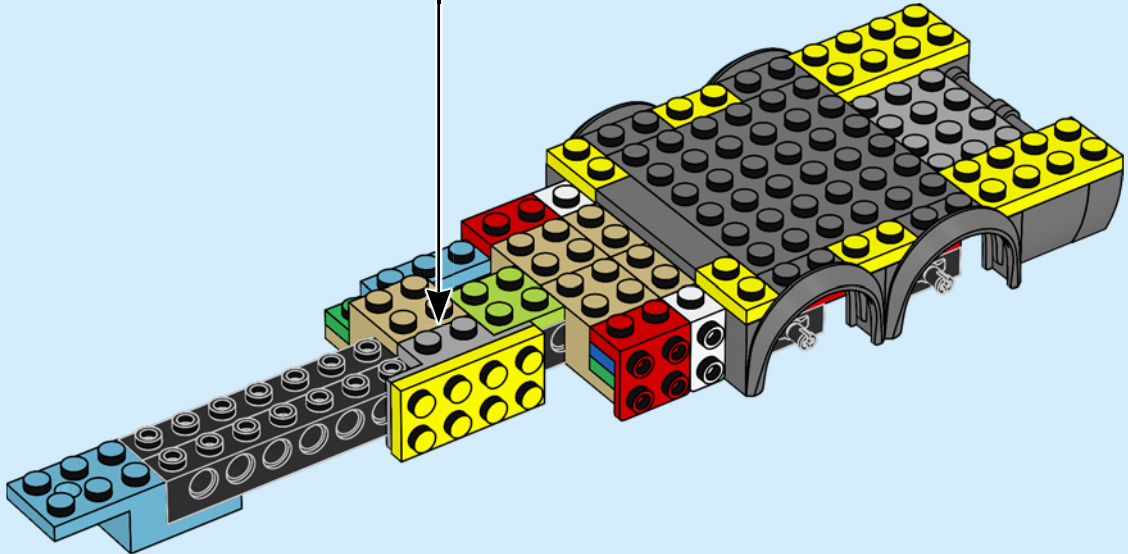
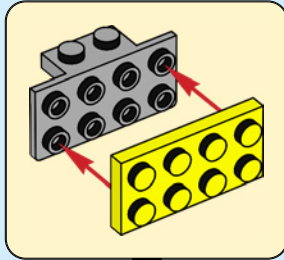



2x

23

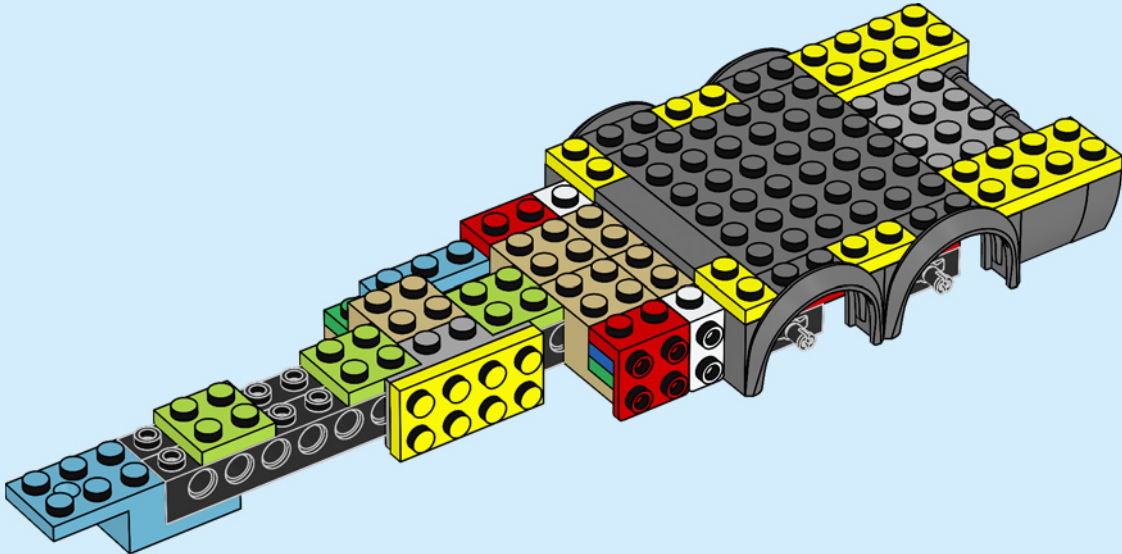

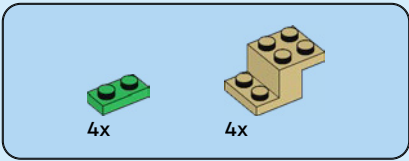

24

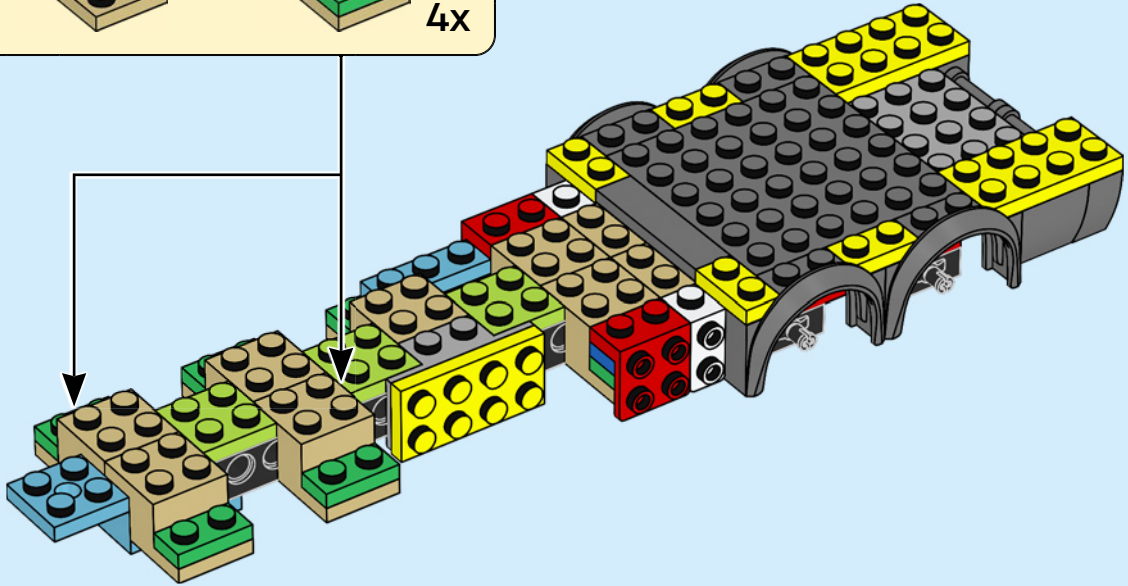
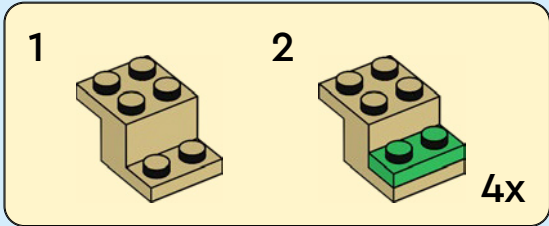

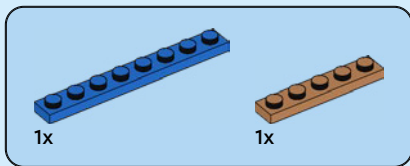

25

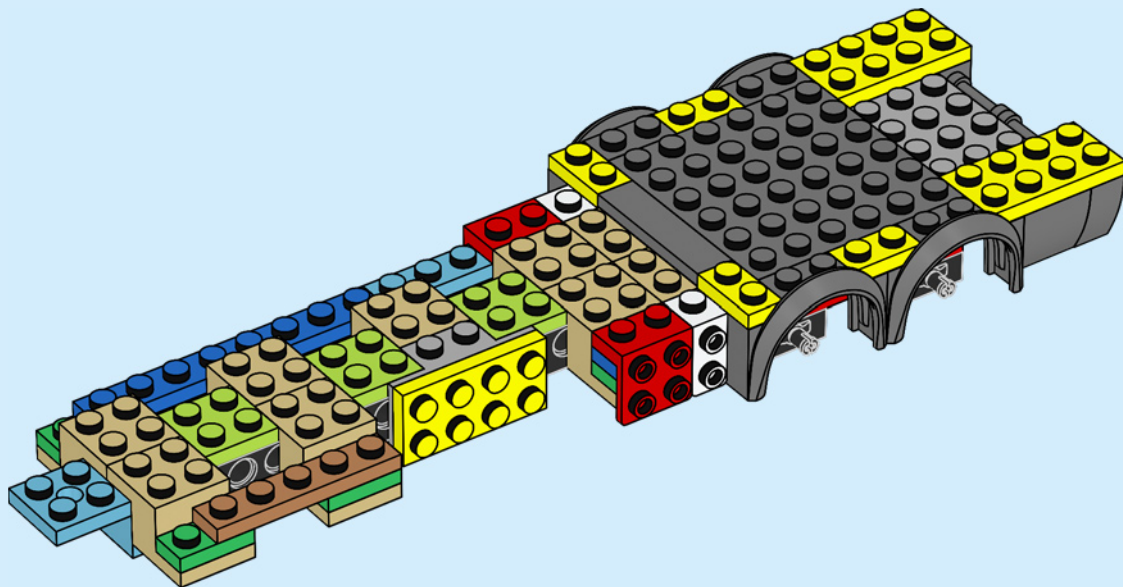



7x



2x

26

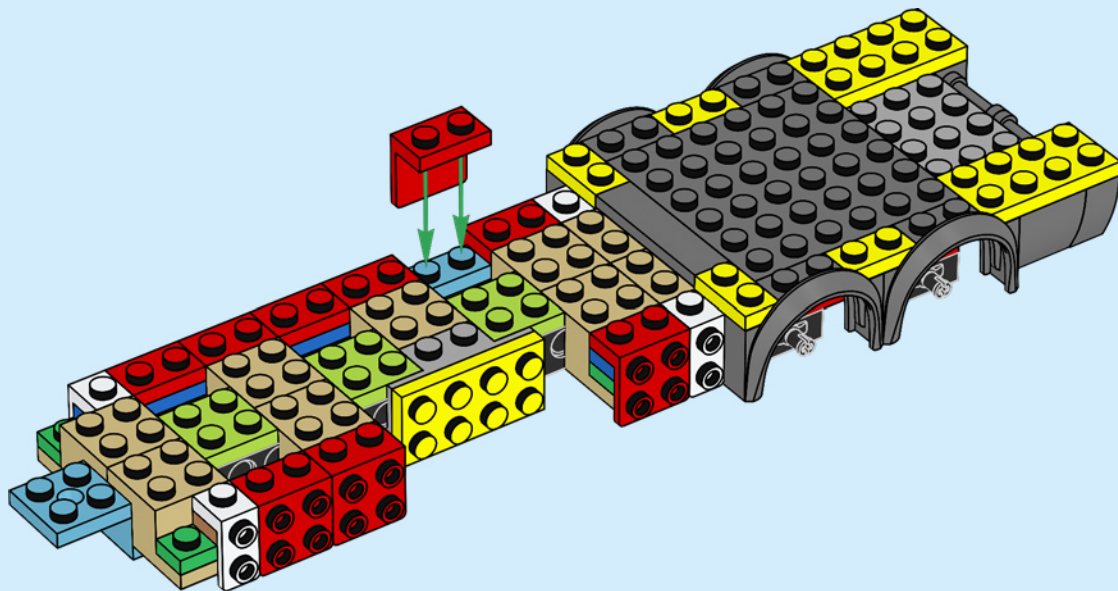

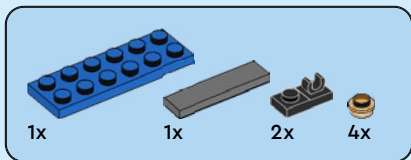

27

1

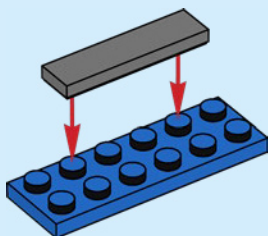

2

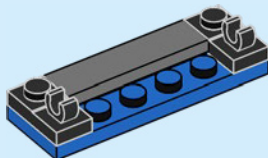

3

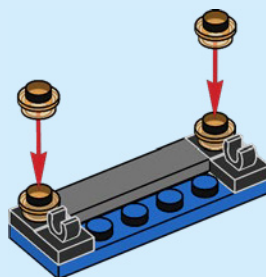

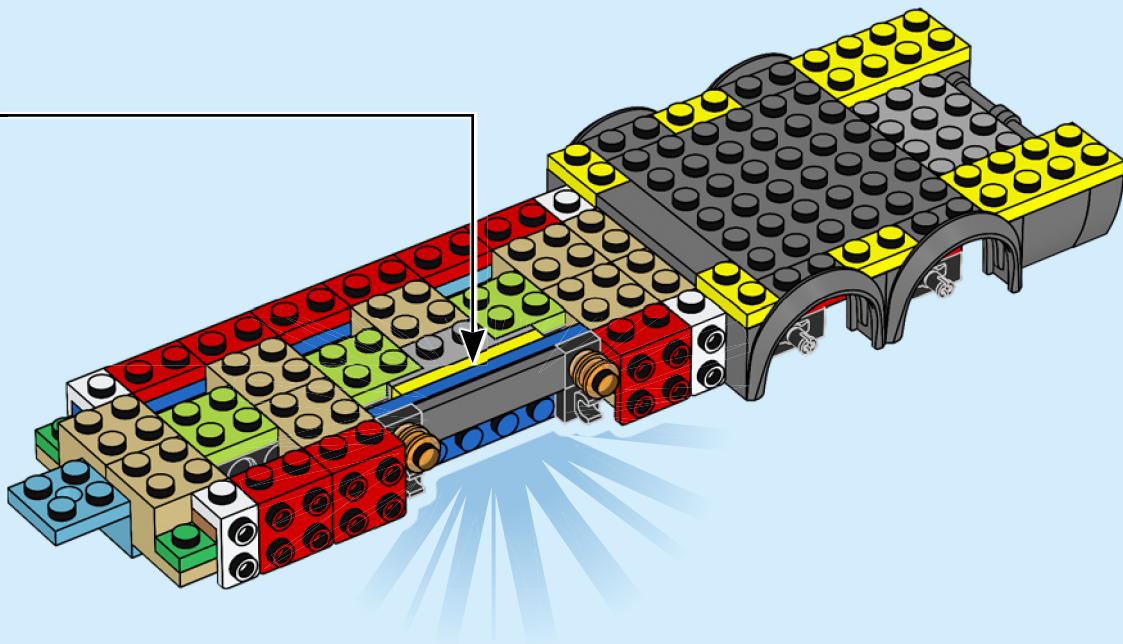

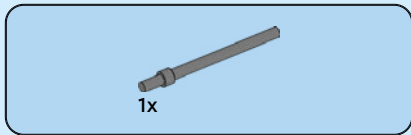

28

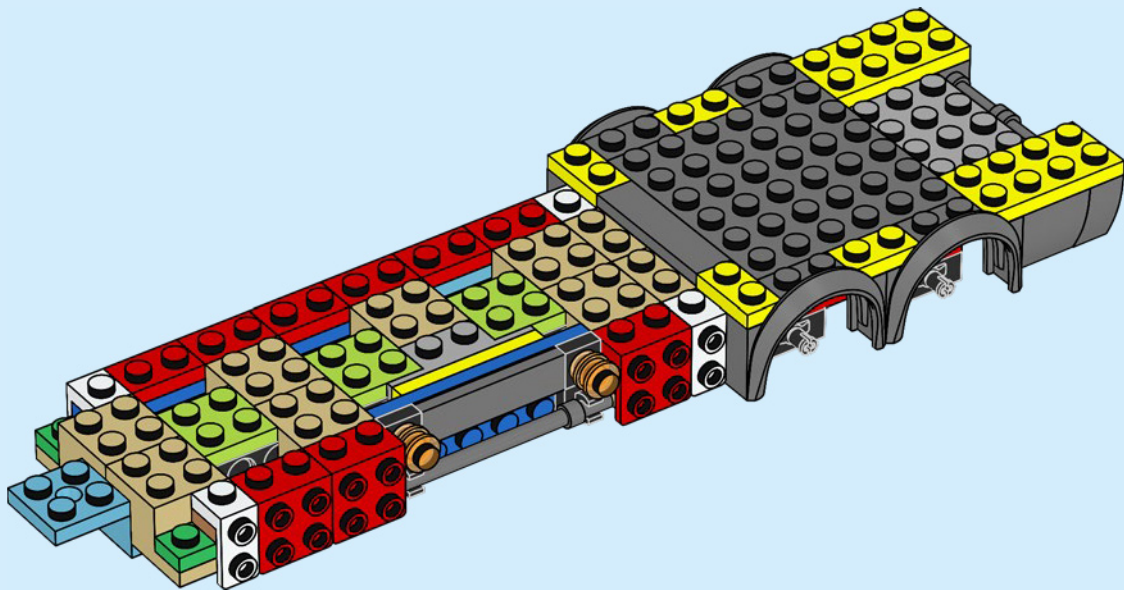

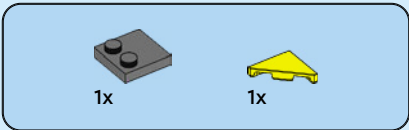

29

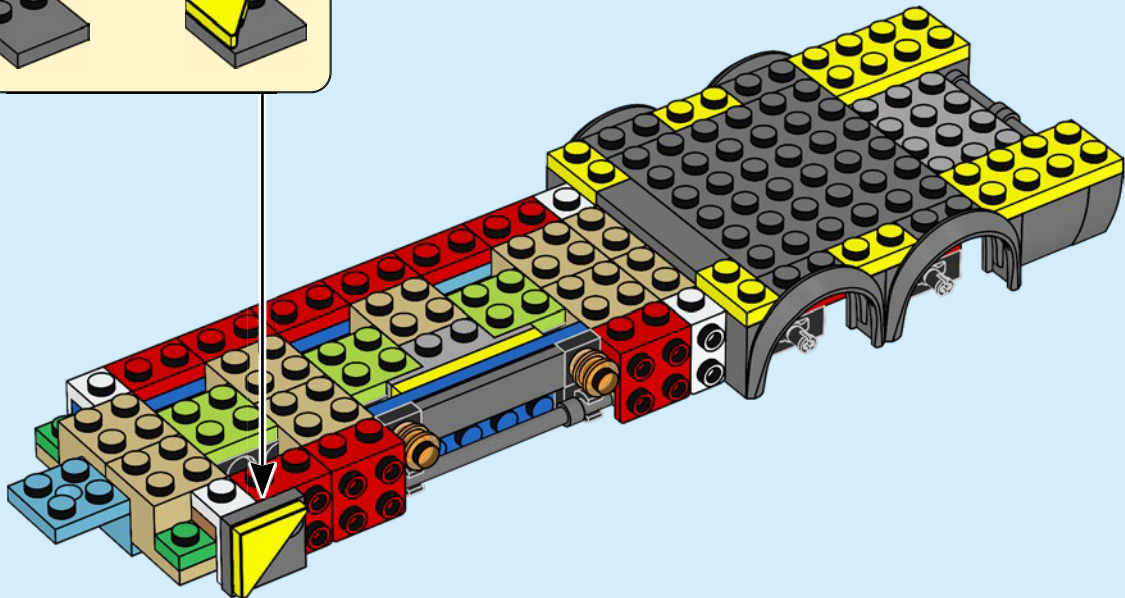
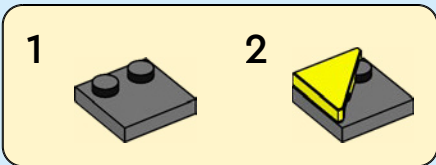

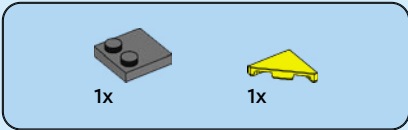

30

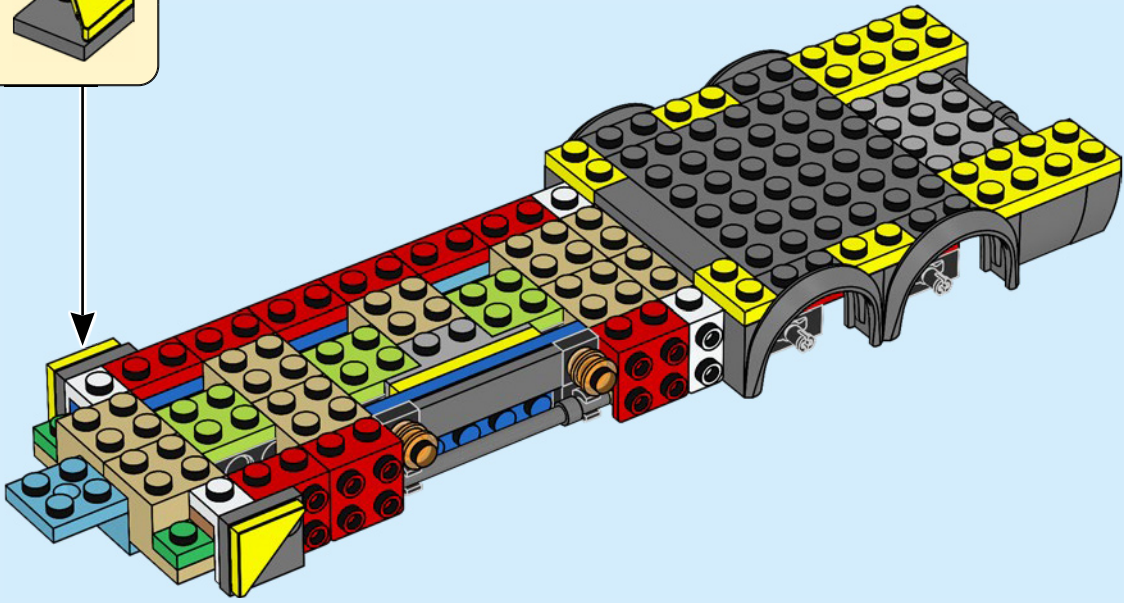
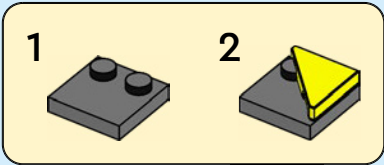

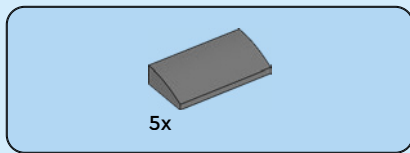

31

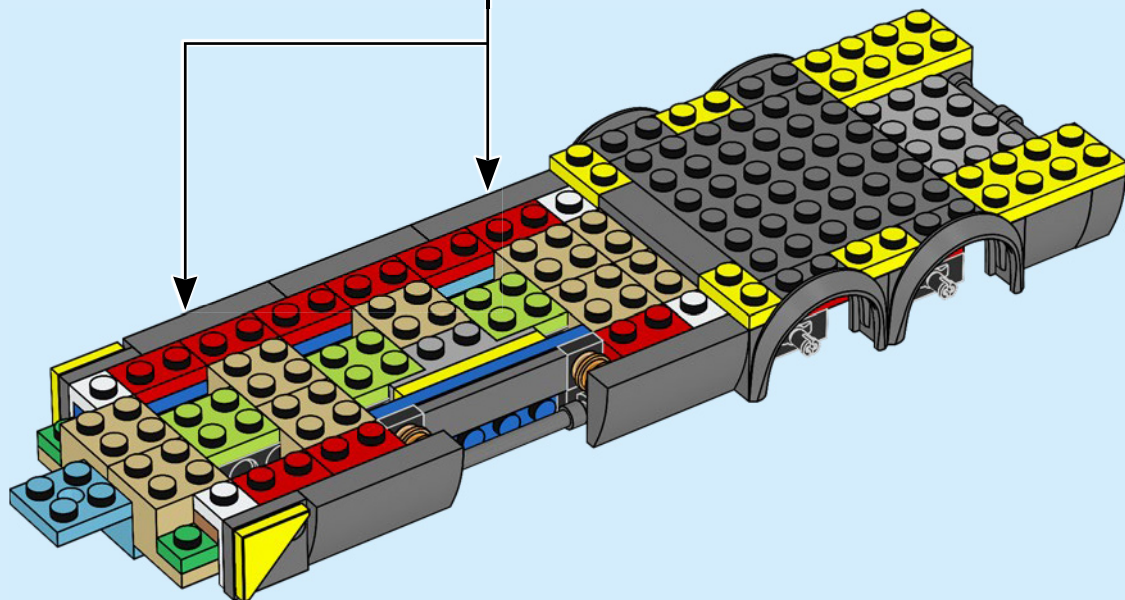
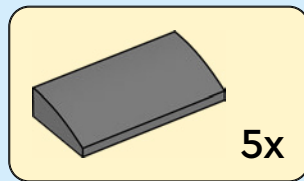

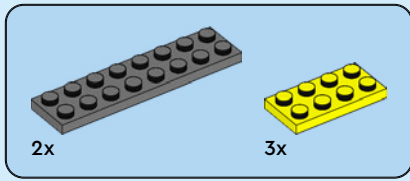

32

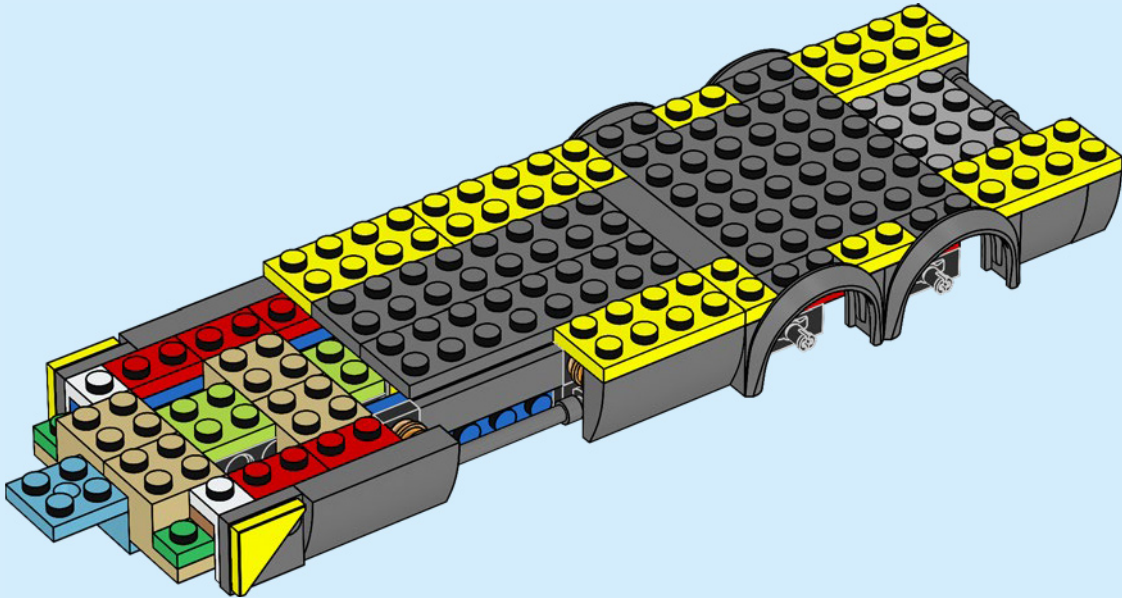

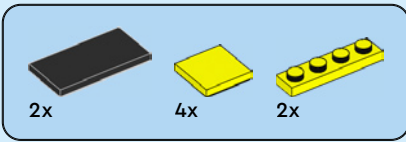

33

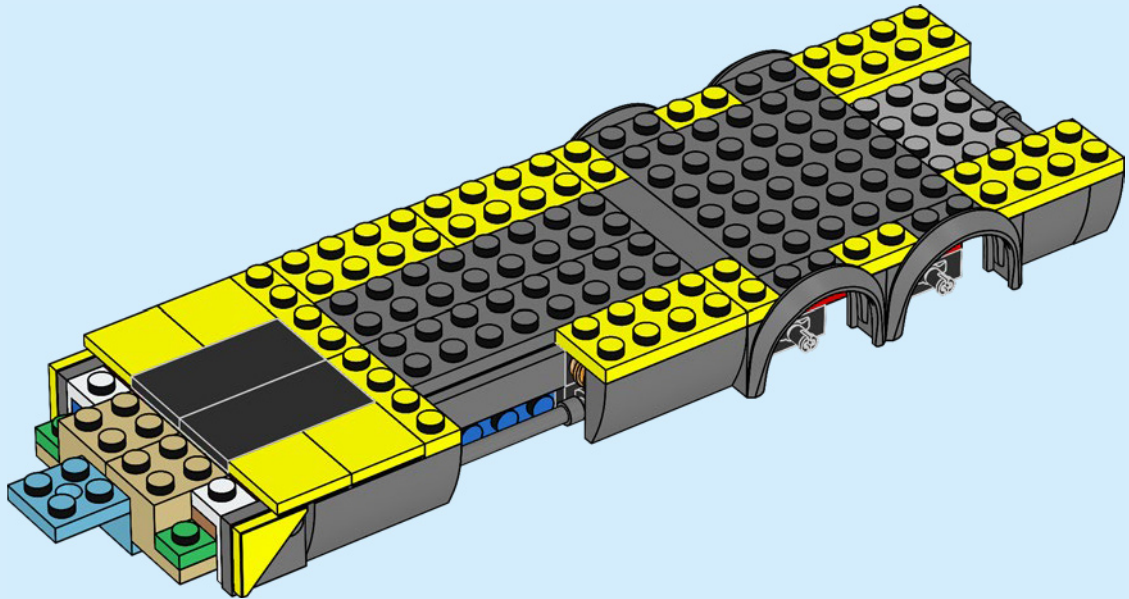

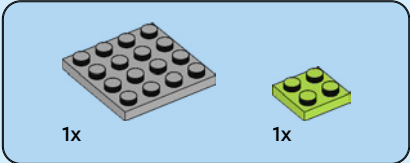
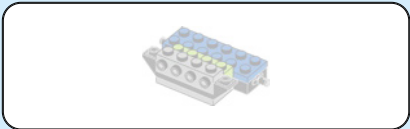

34

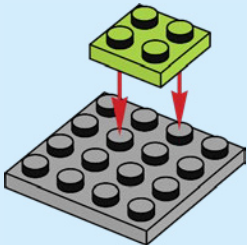



2x

35

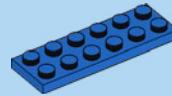
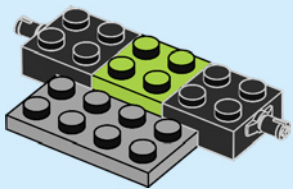

1x

36

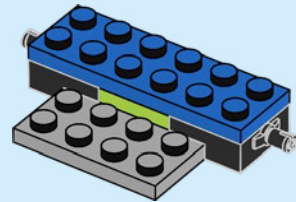

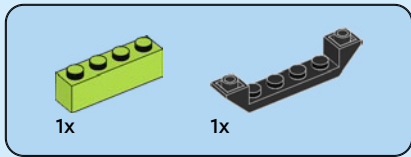

37

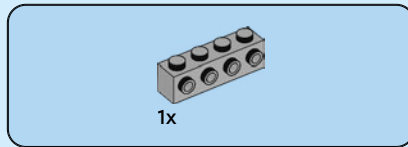
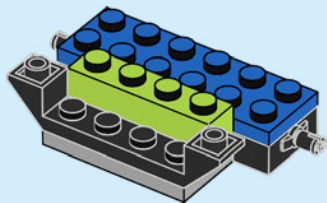

38

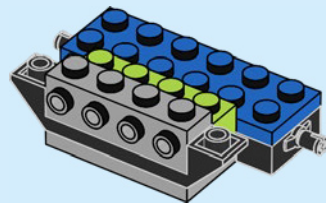

39

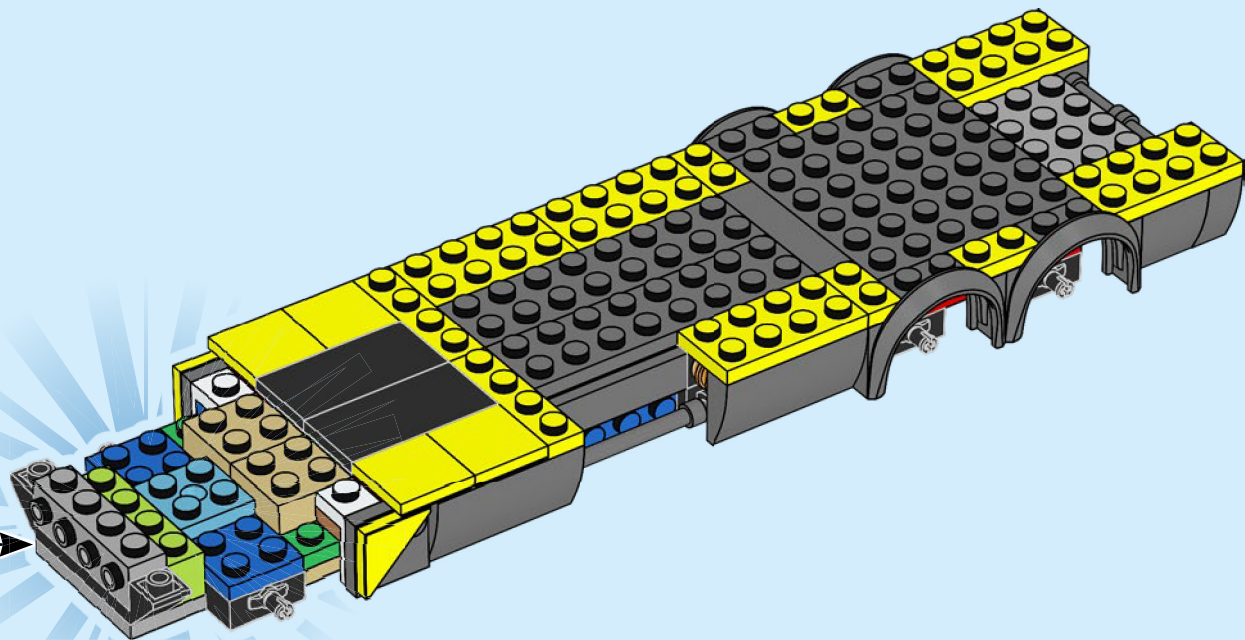



1x

40

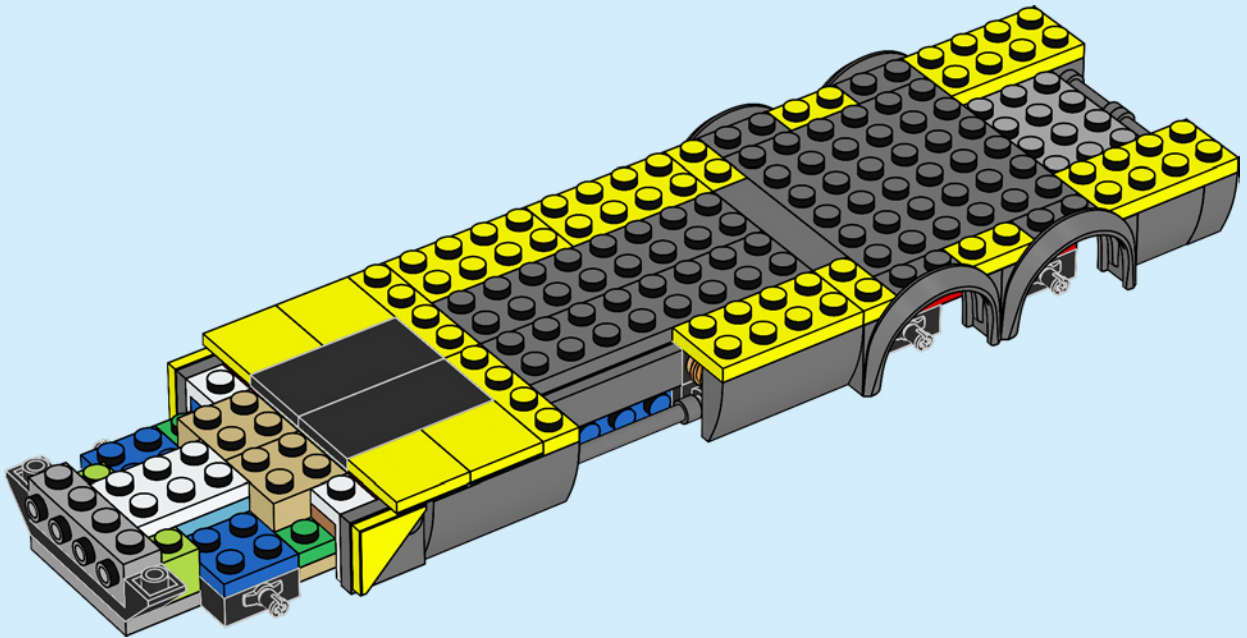

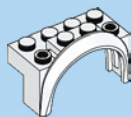

2x

41

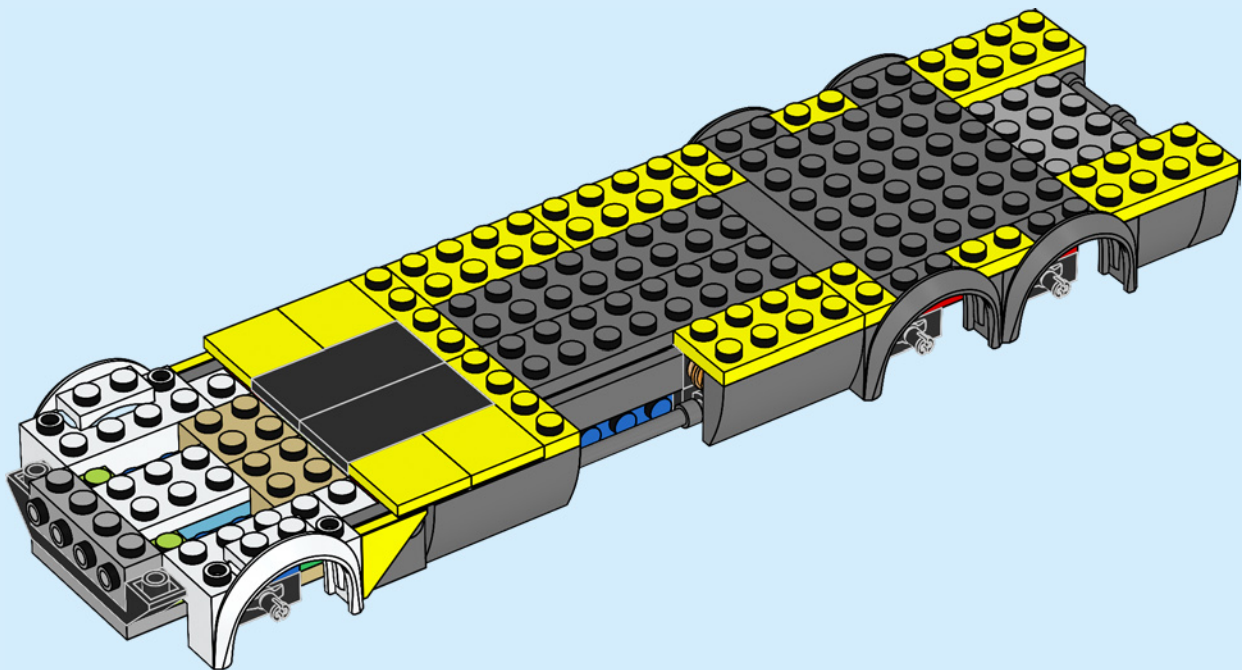

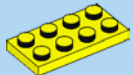

2x

42

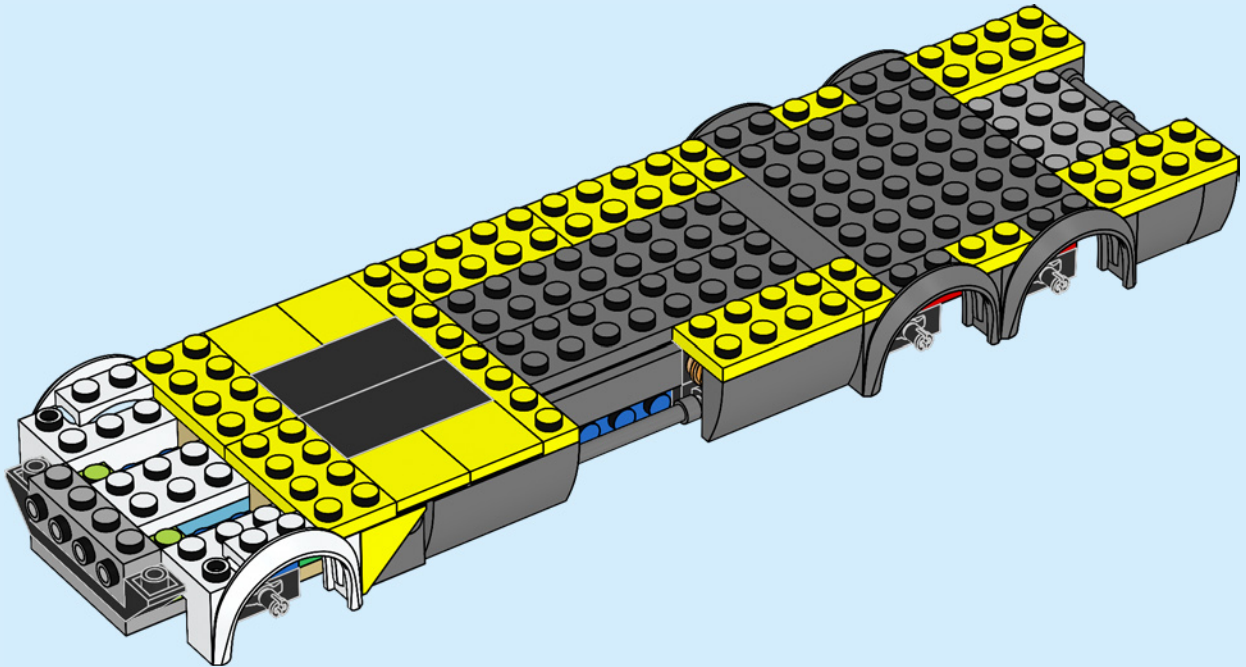

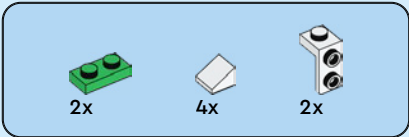

43

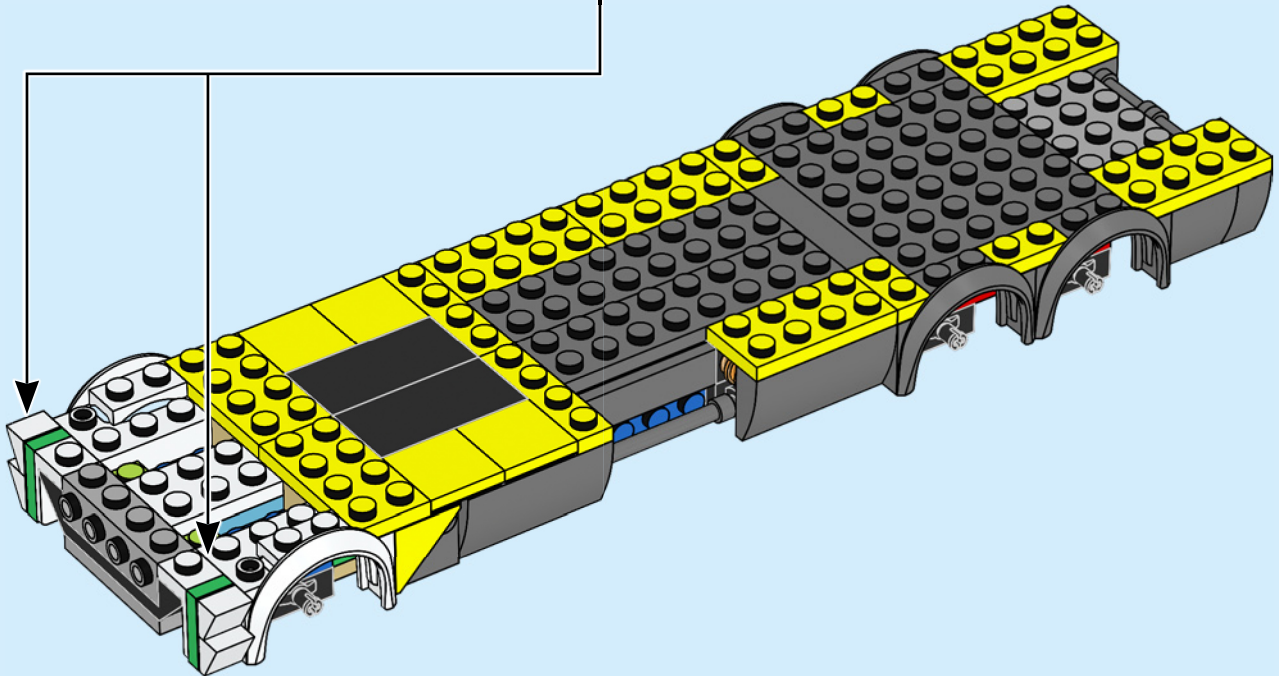
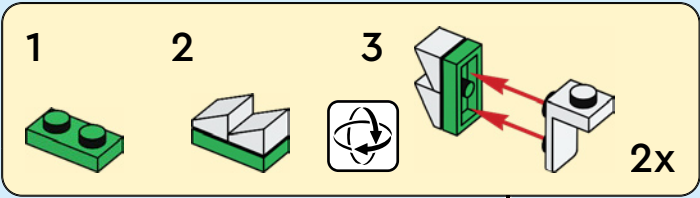

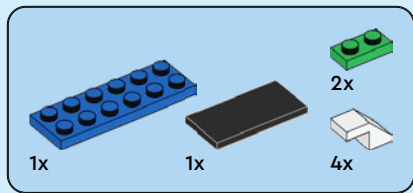

44

1

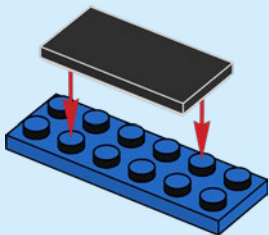

2

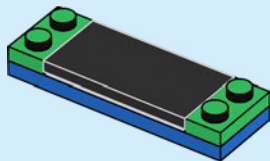

3

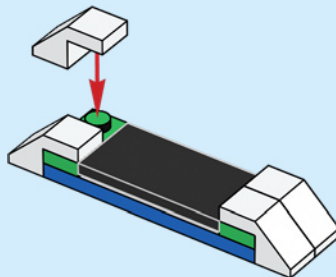

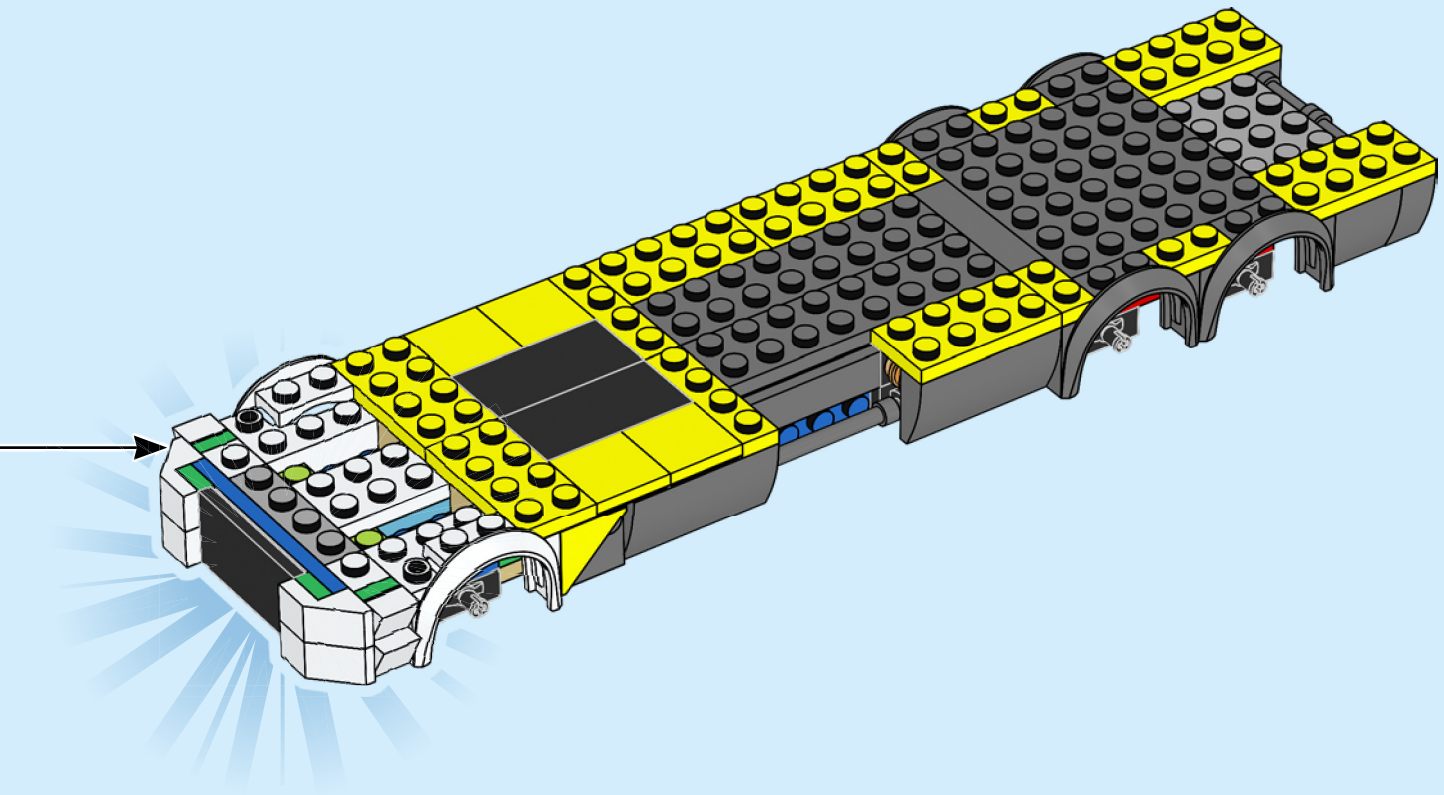



4x

45

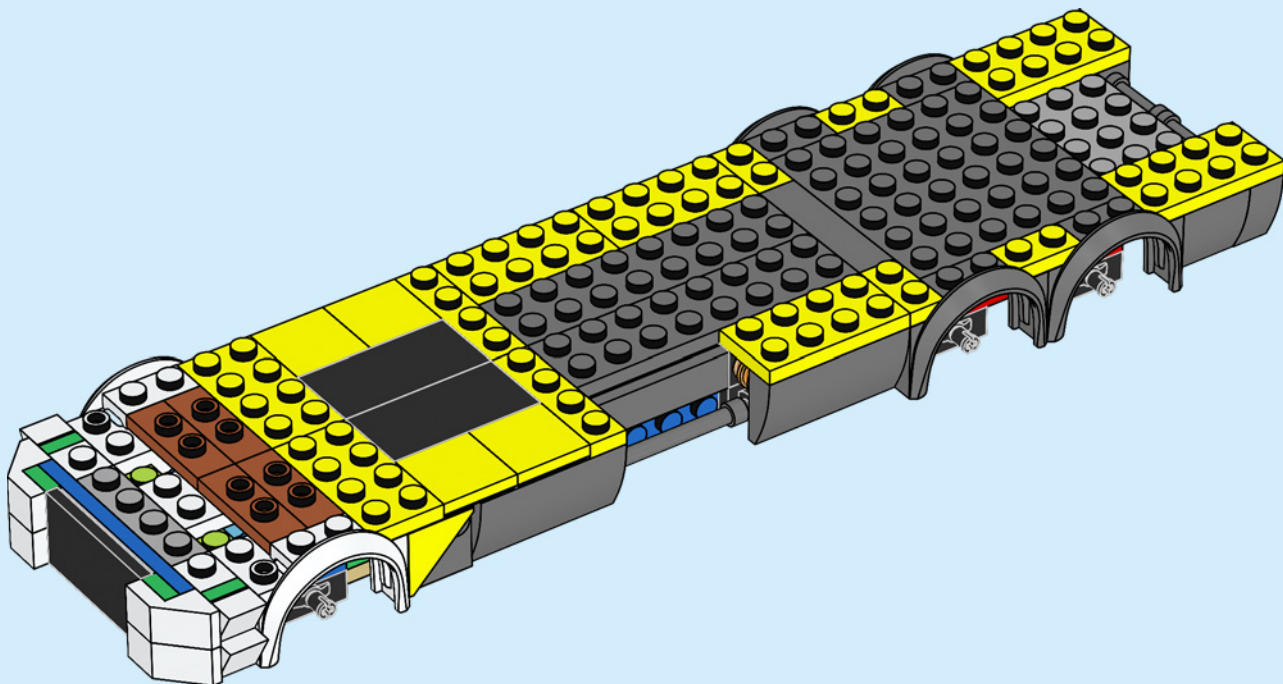

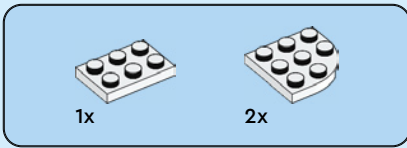

46

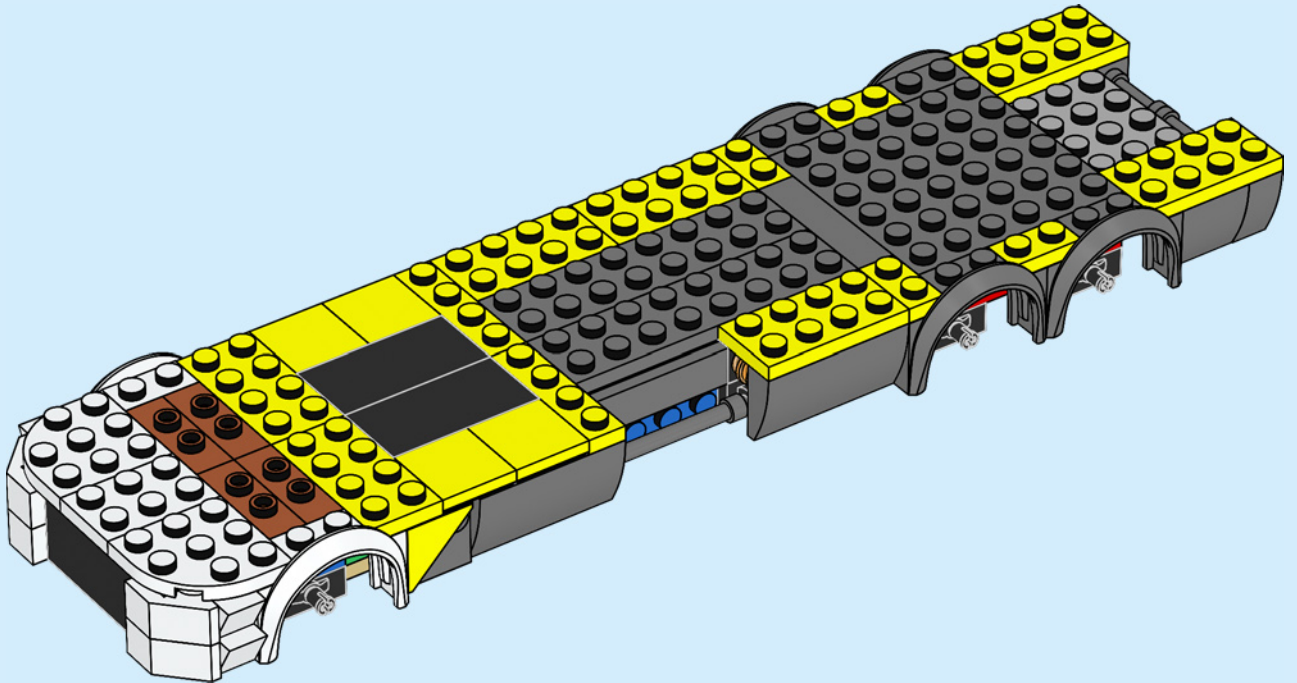

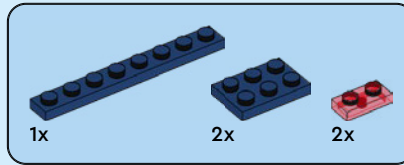

47

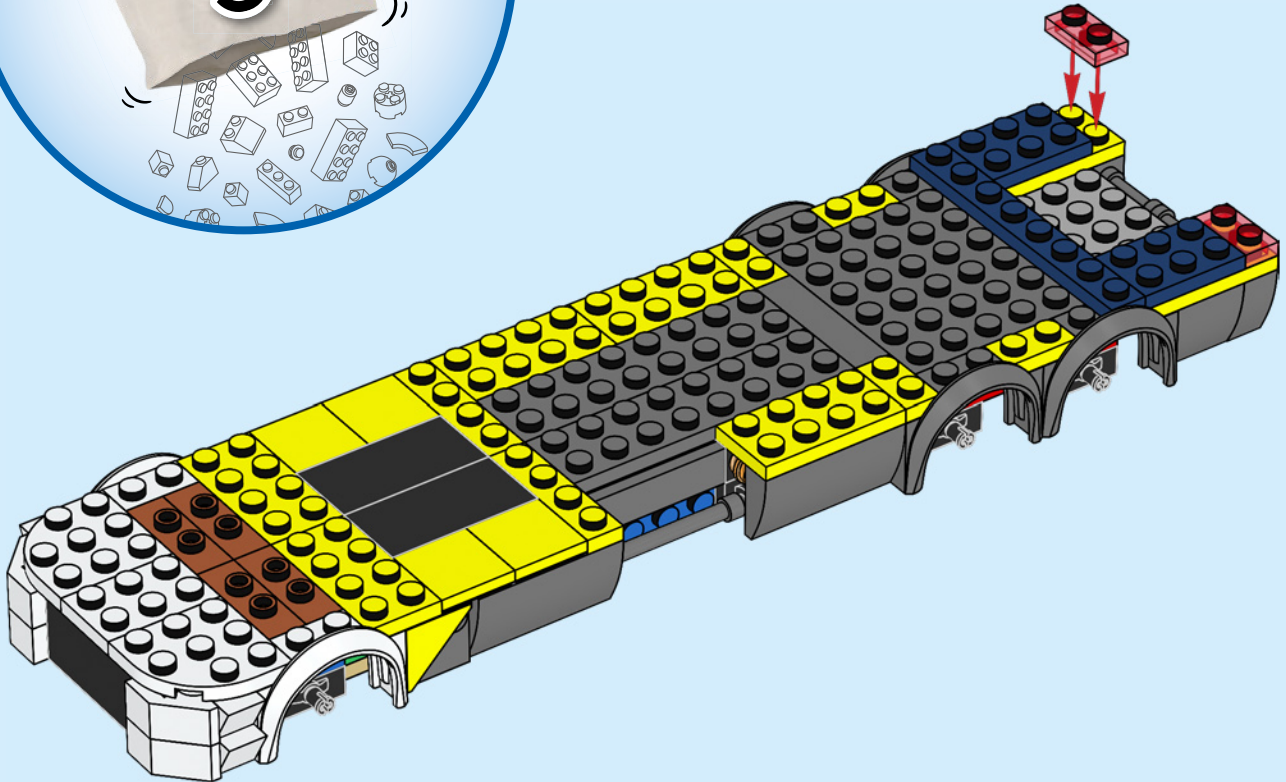

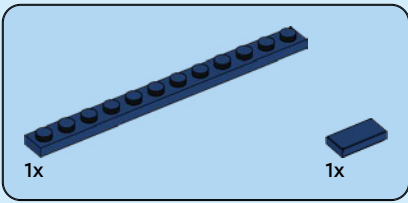

48

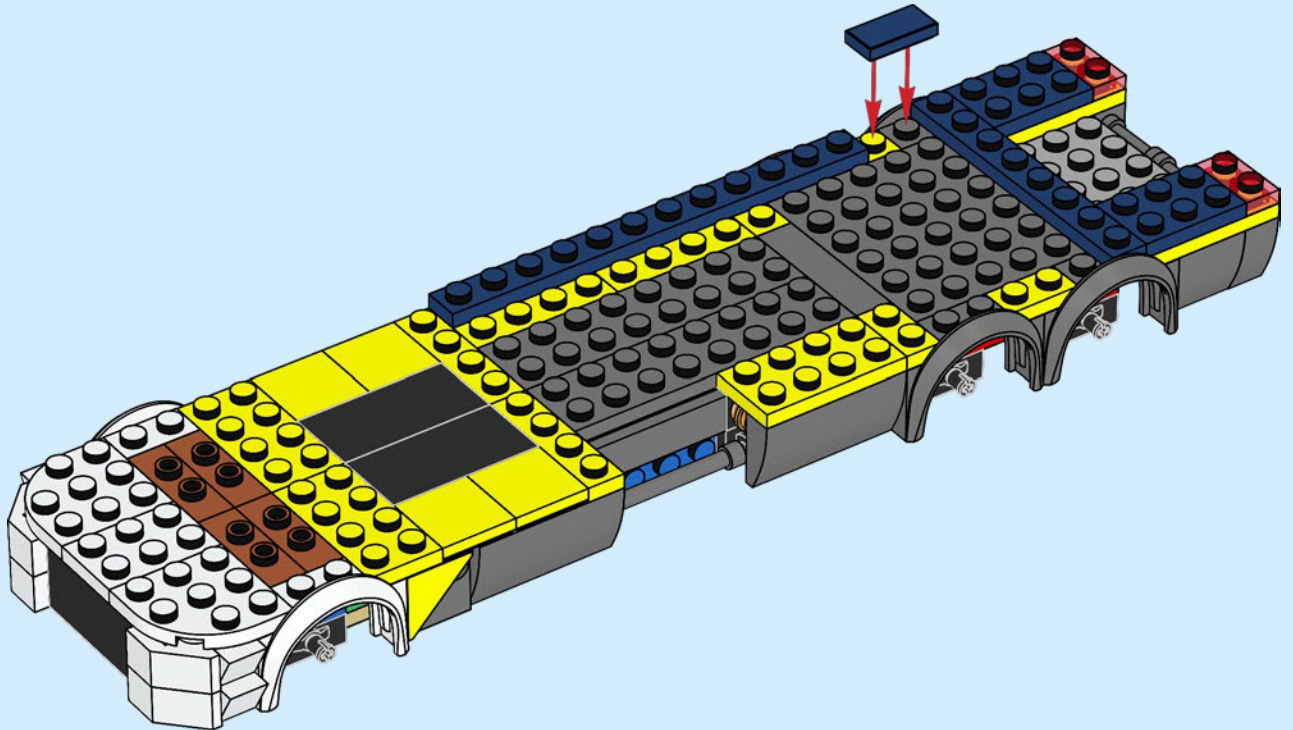

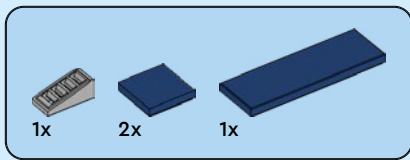

49

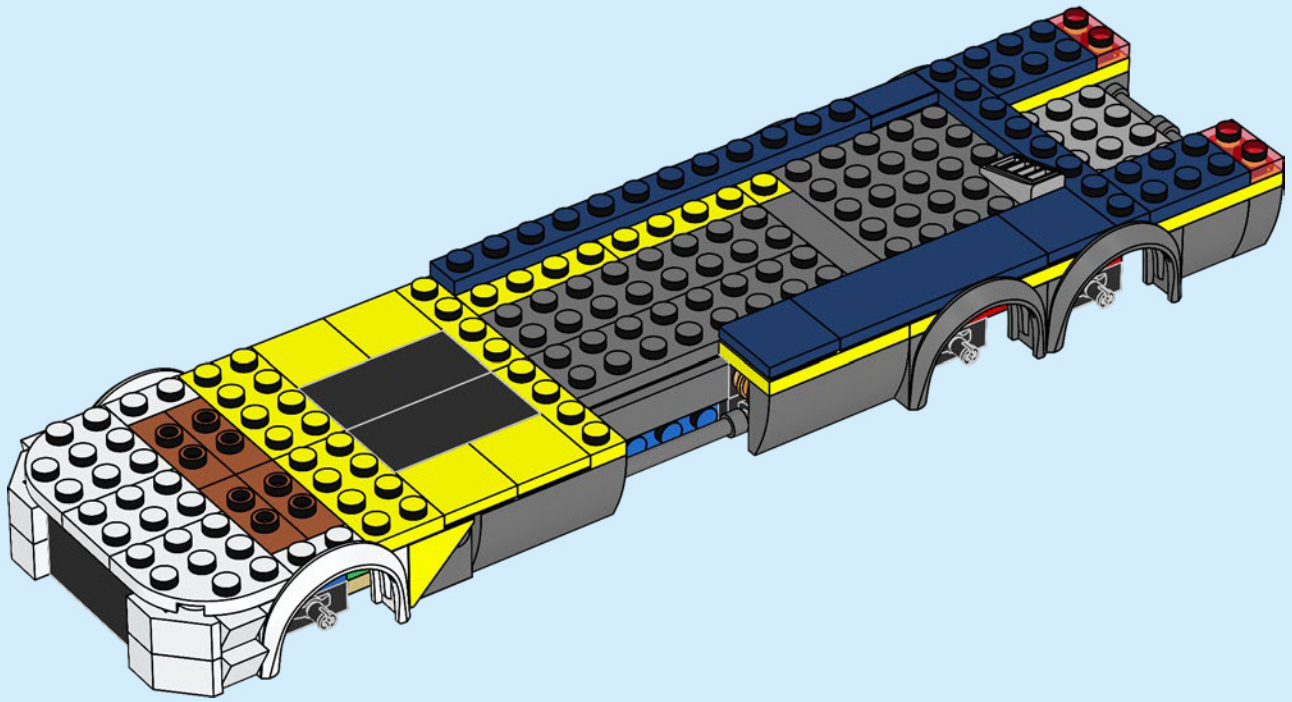

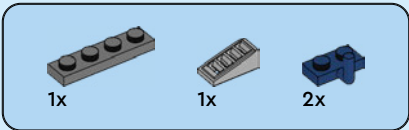

50

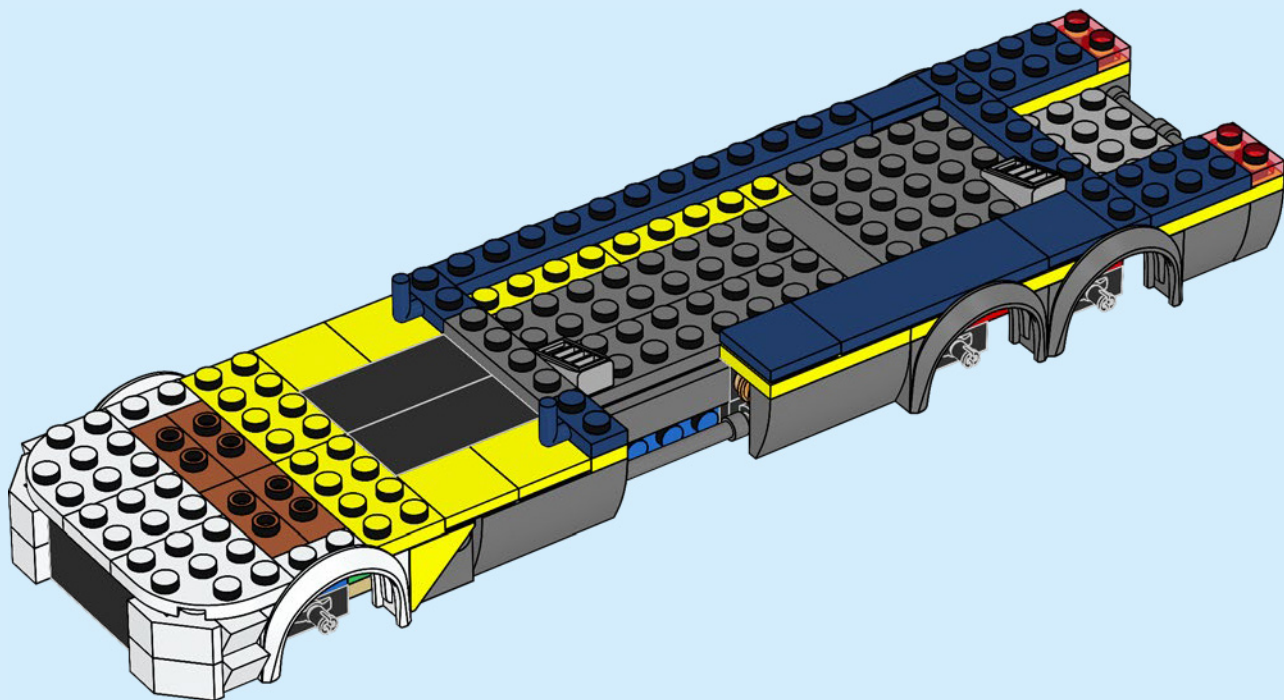

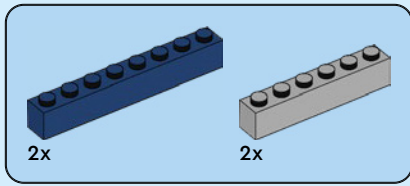

51

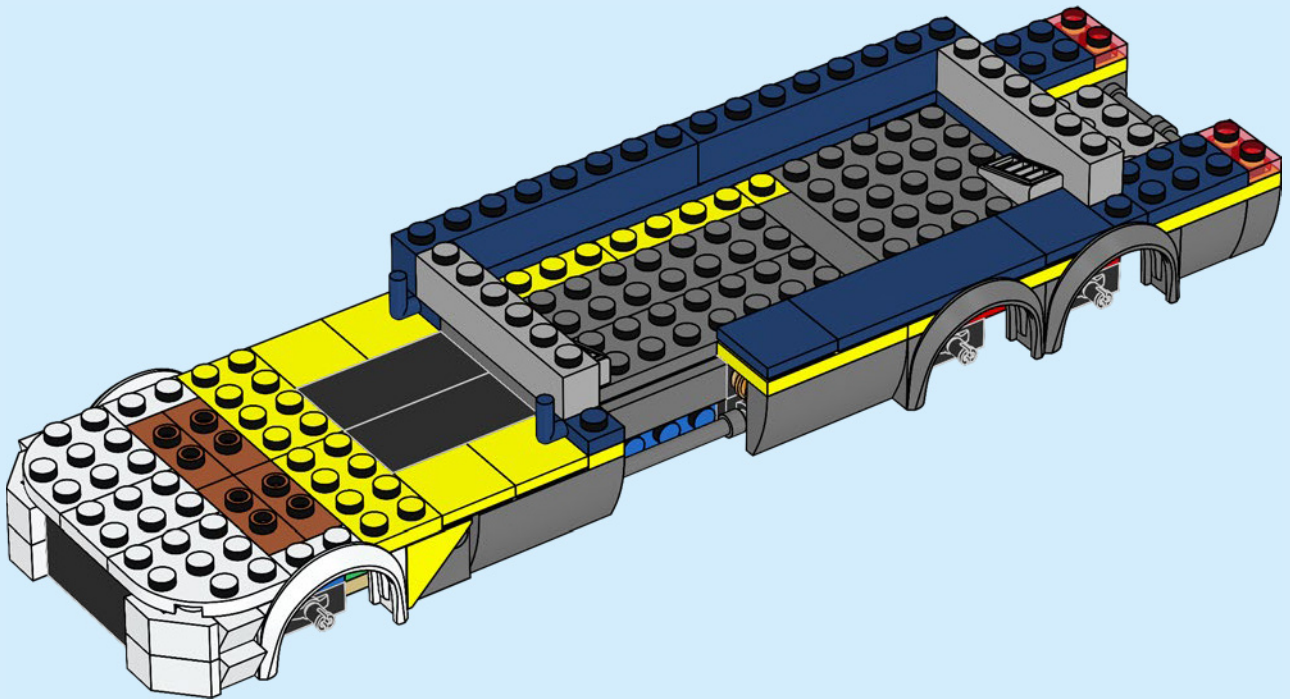

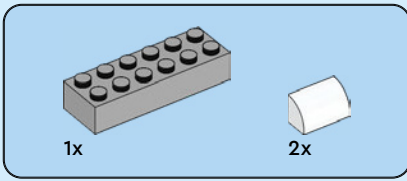

52

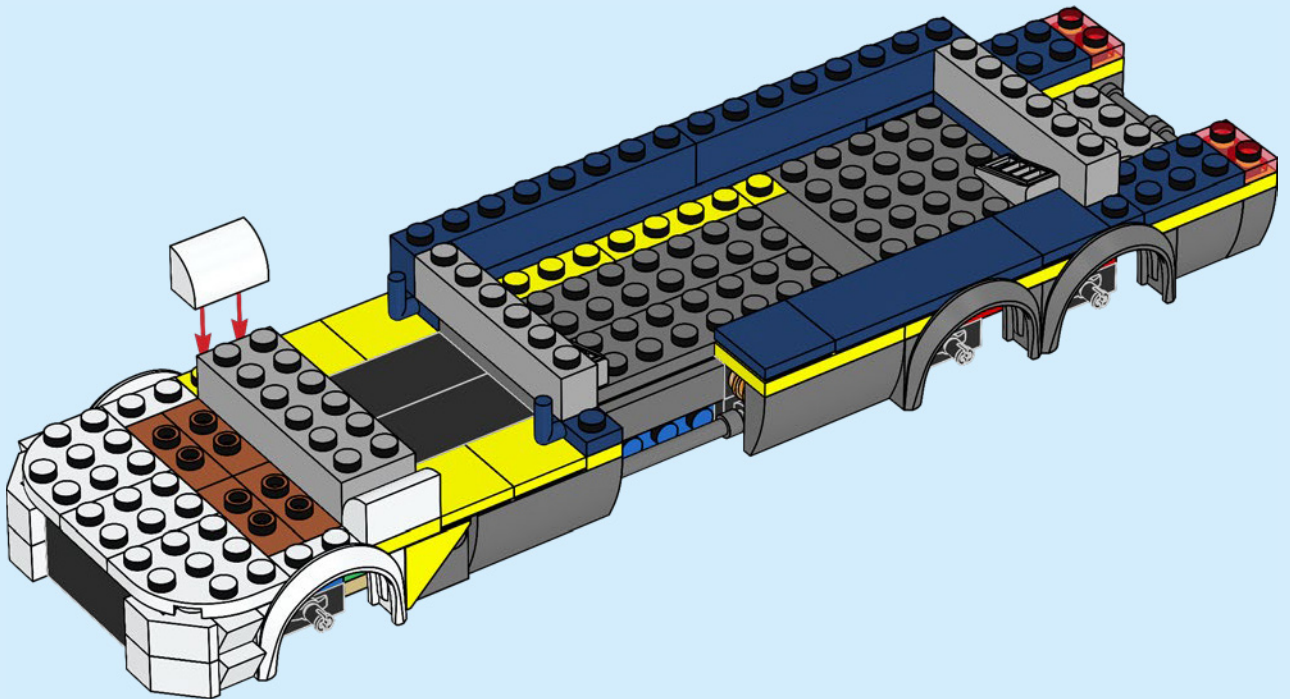



2x

53

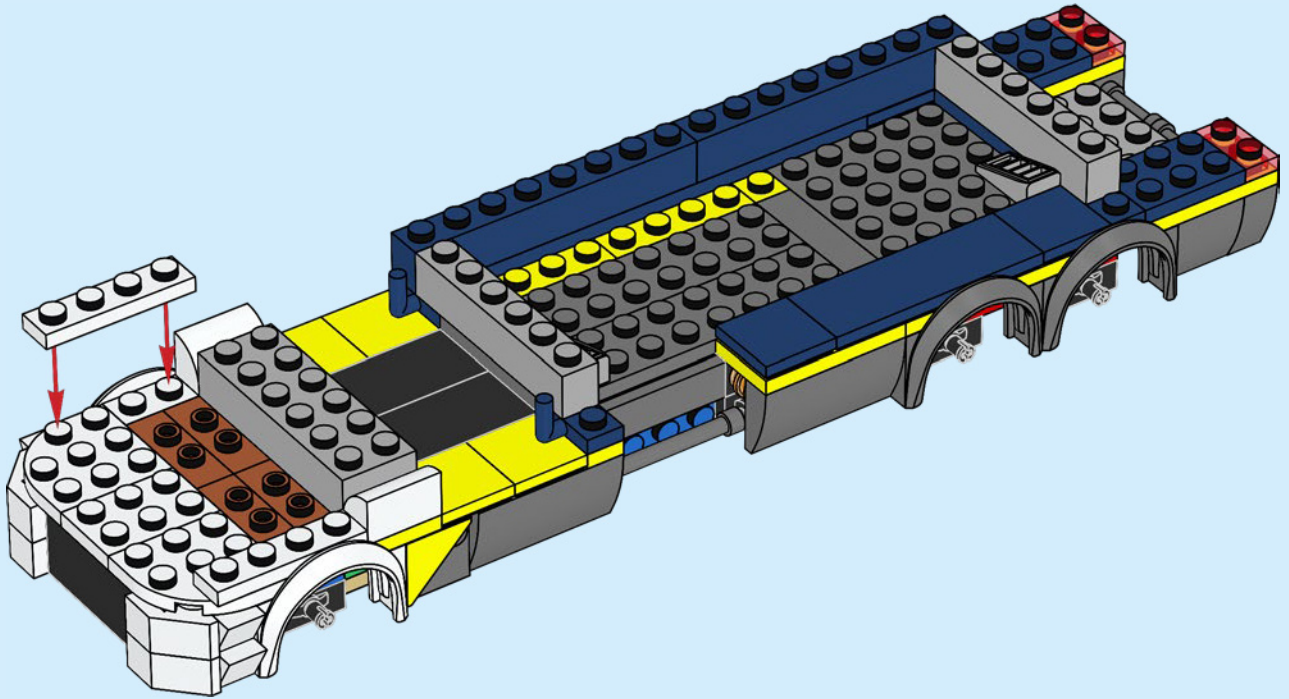

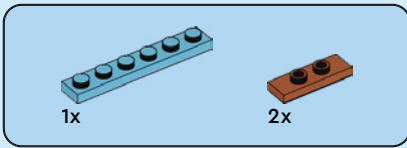

54

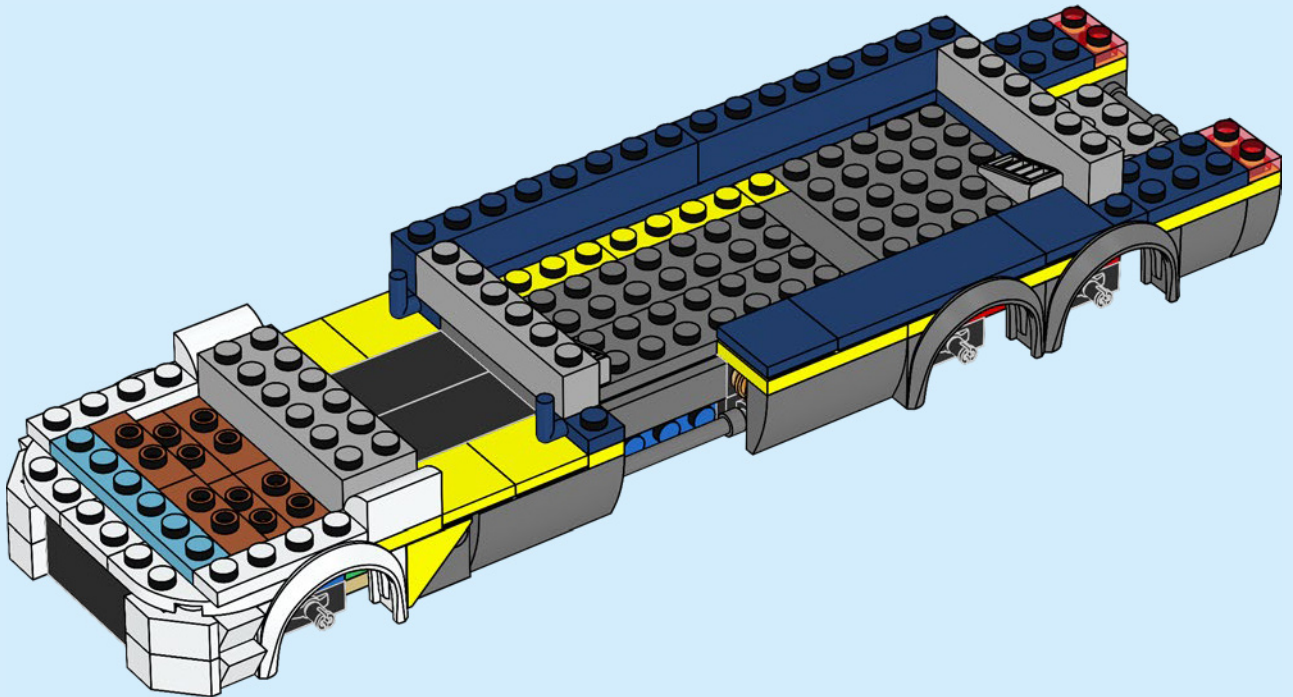

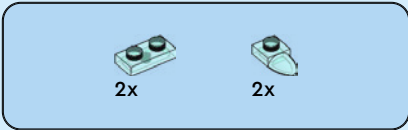

55

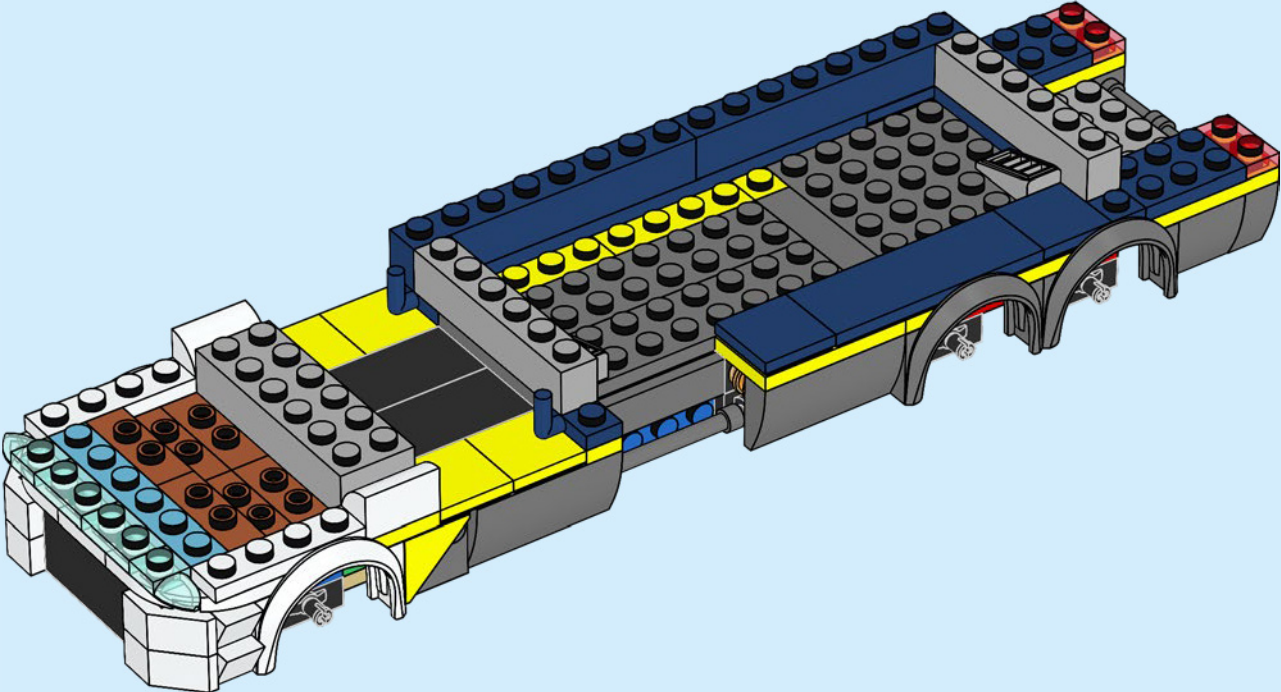



1x



1x

56

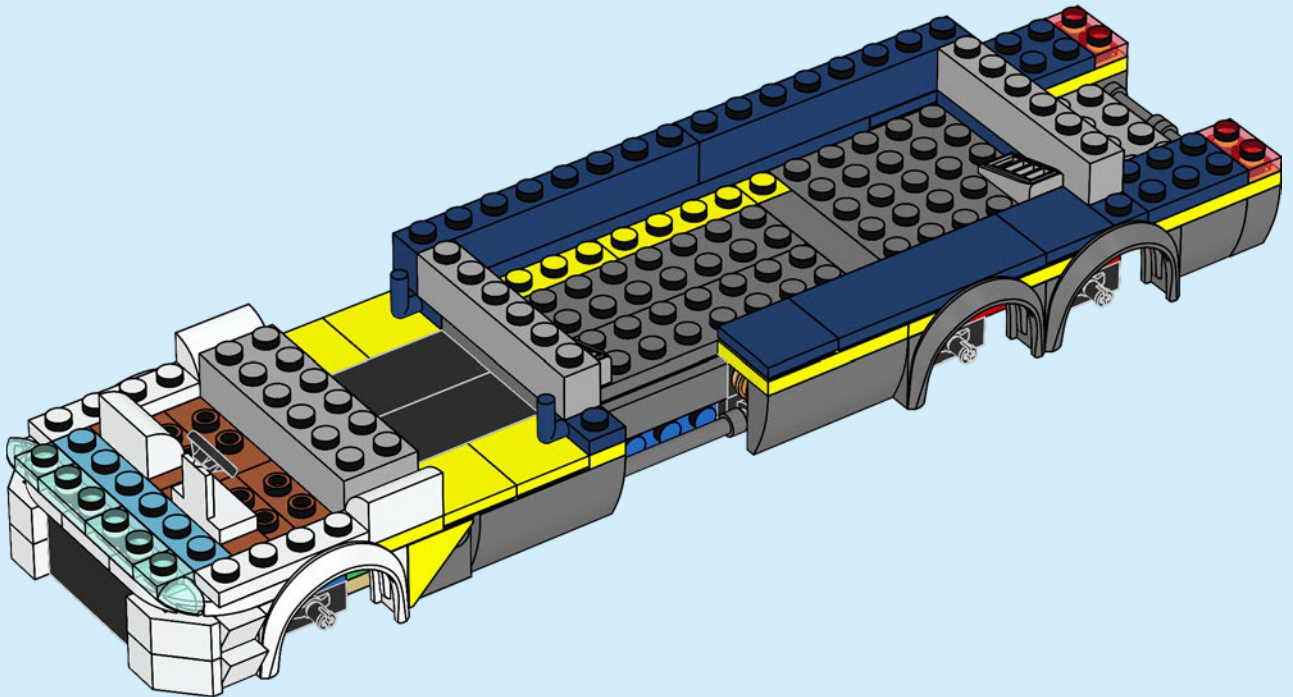

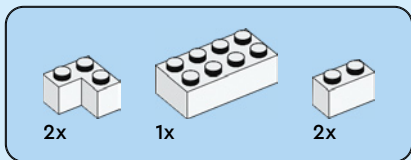

57

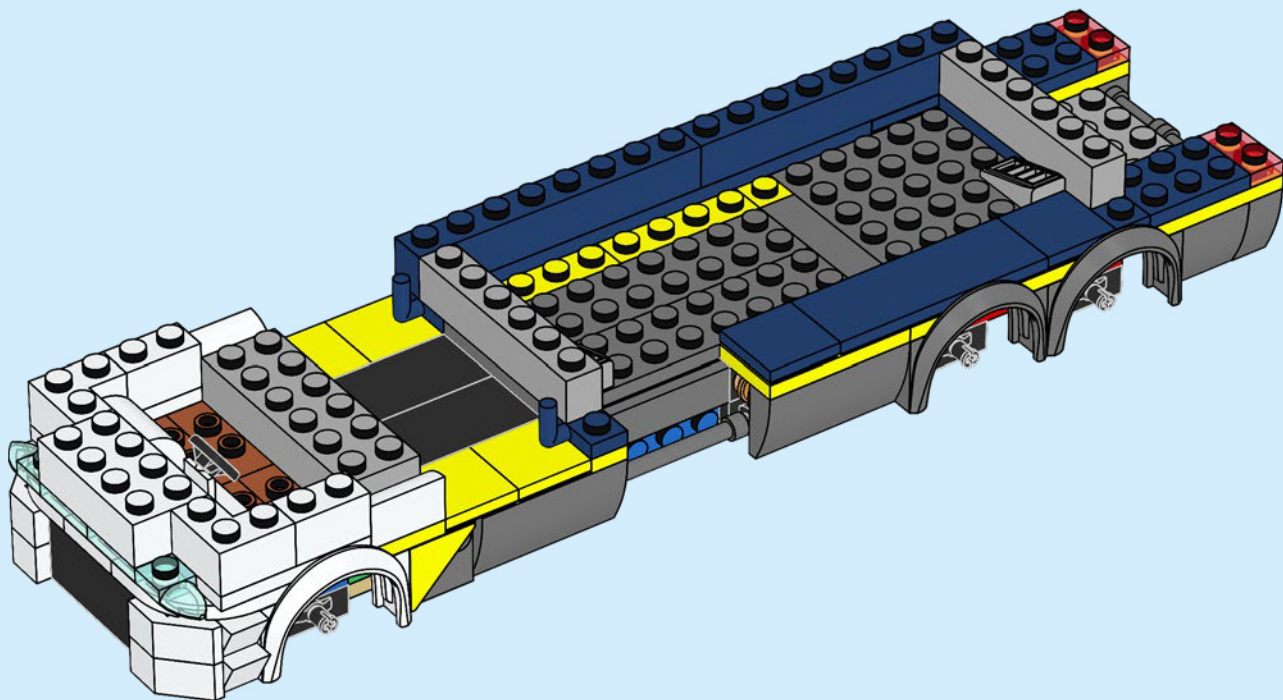

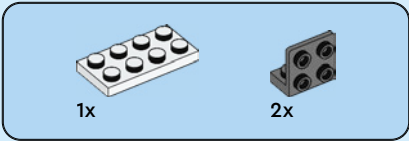

58

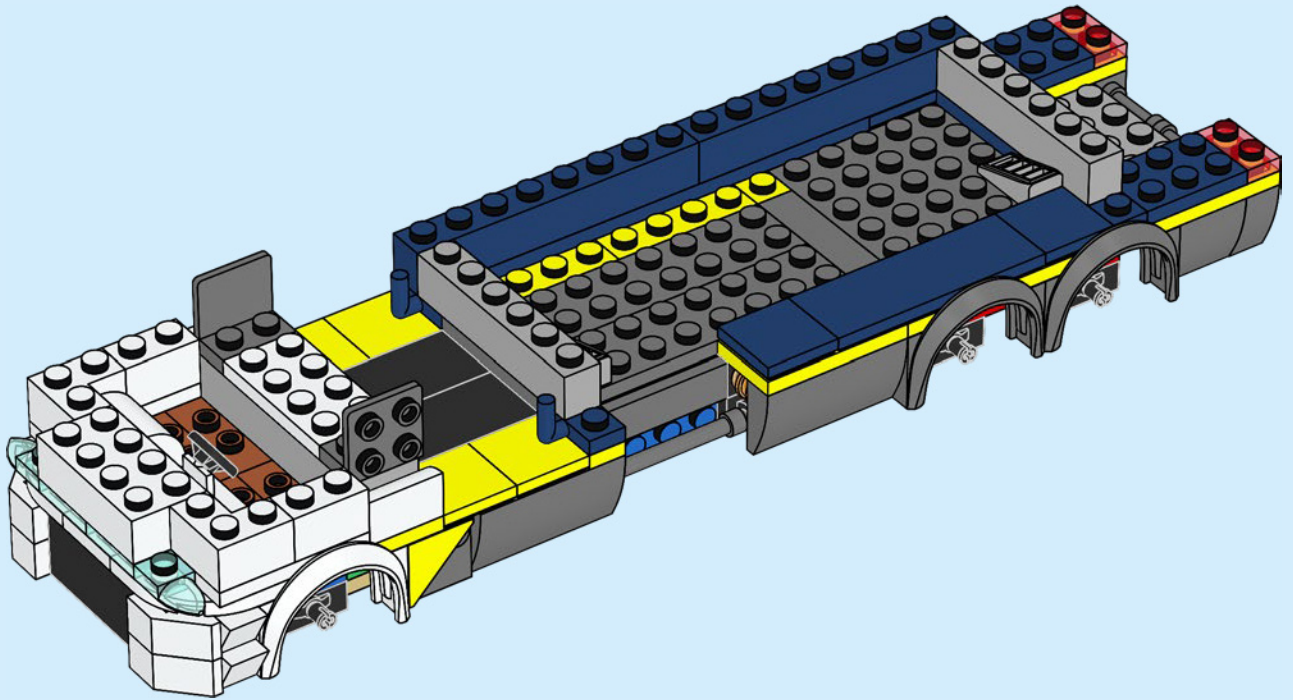

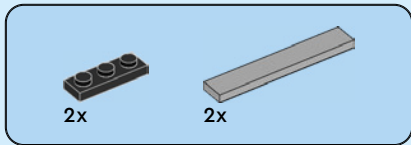

59

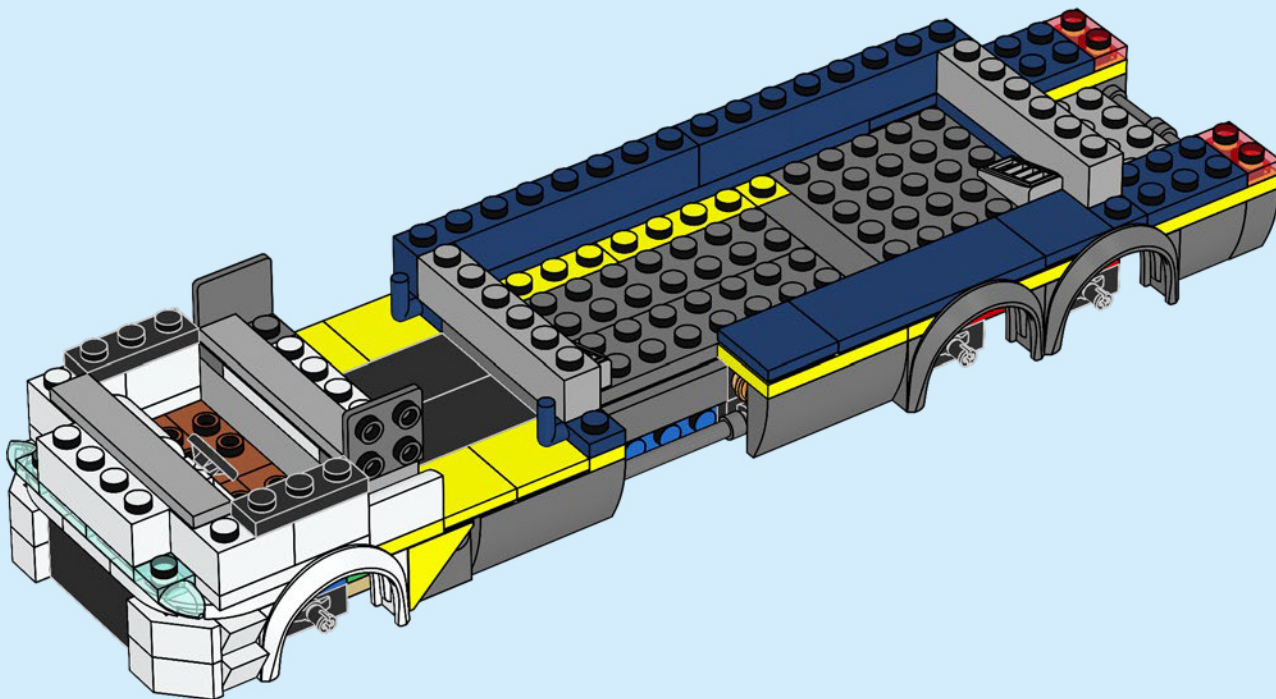



1x



1x



1x

60

1

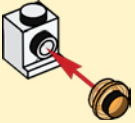

2

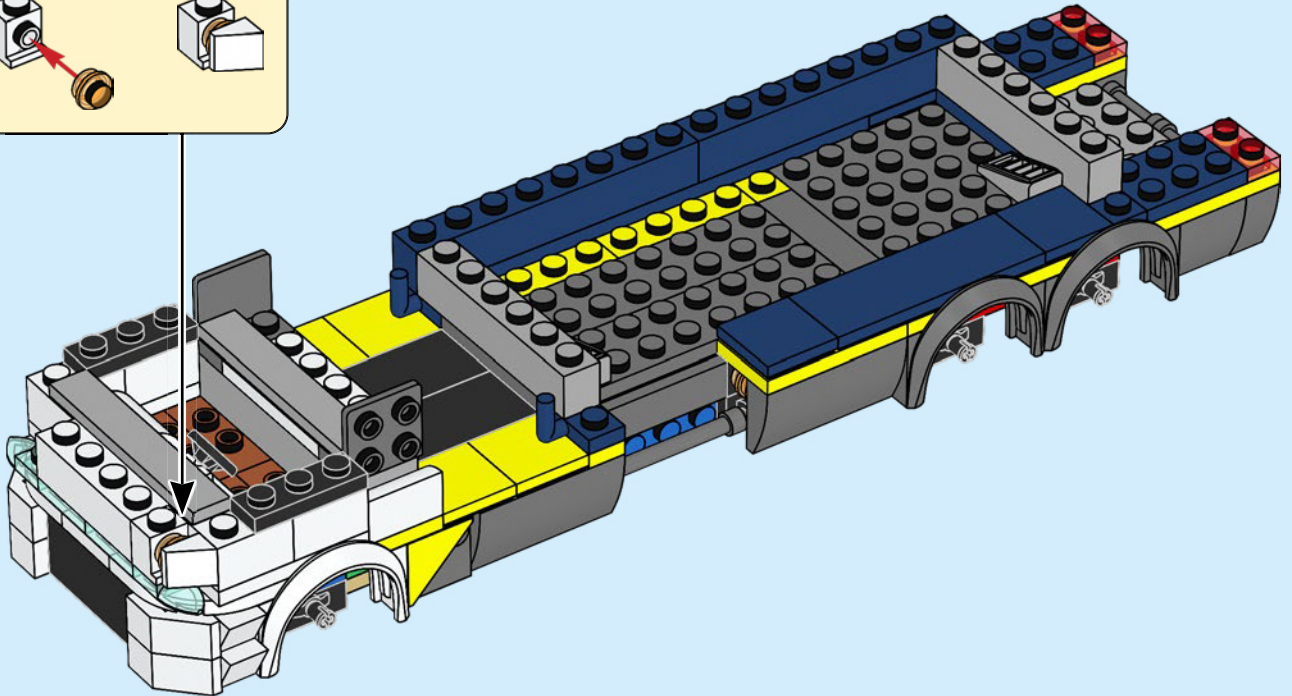



1x



1x



1x

61

1

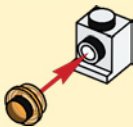

2

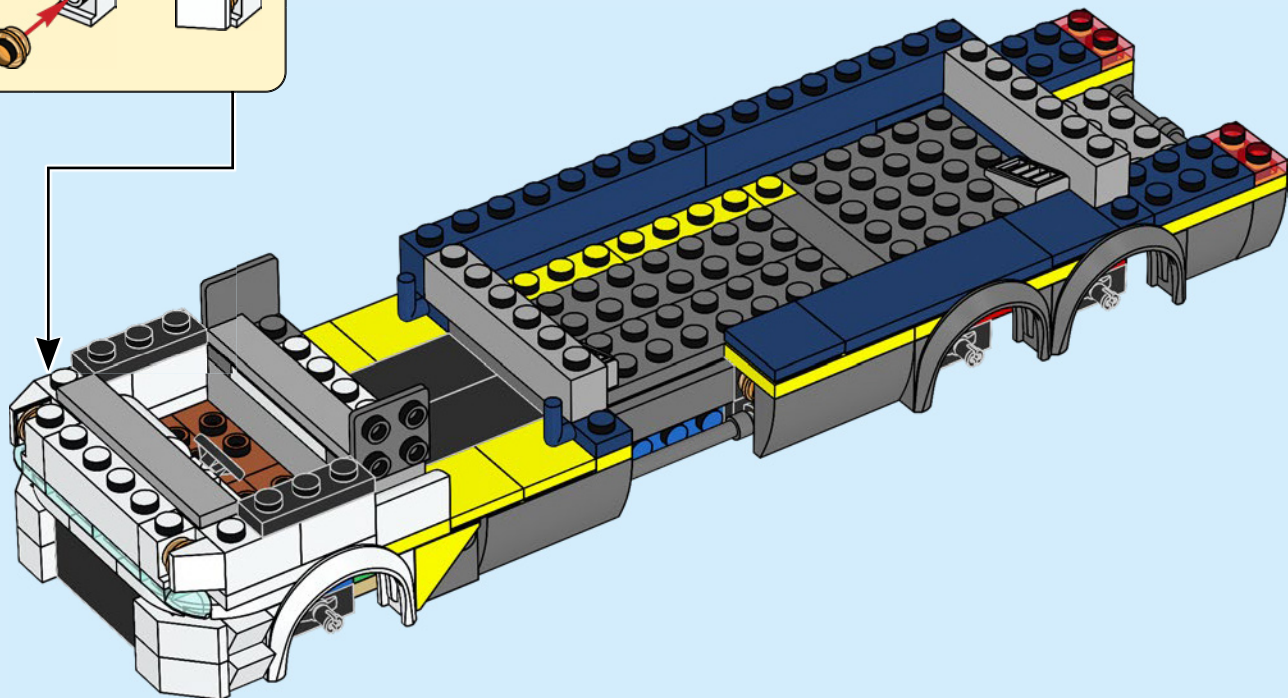



2x



2x

62

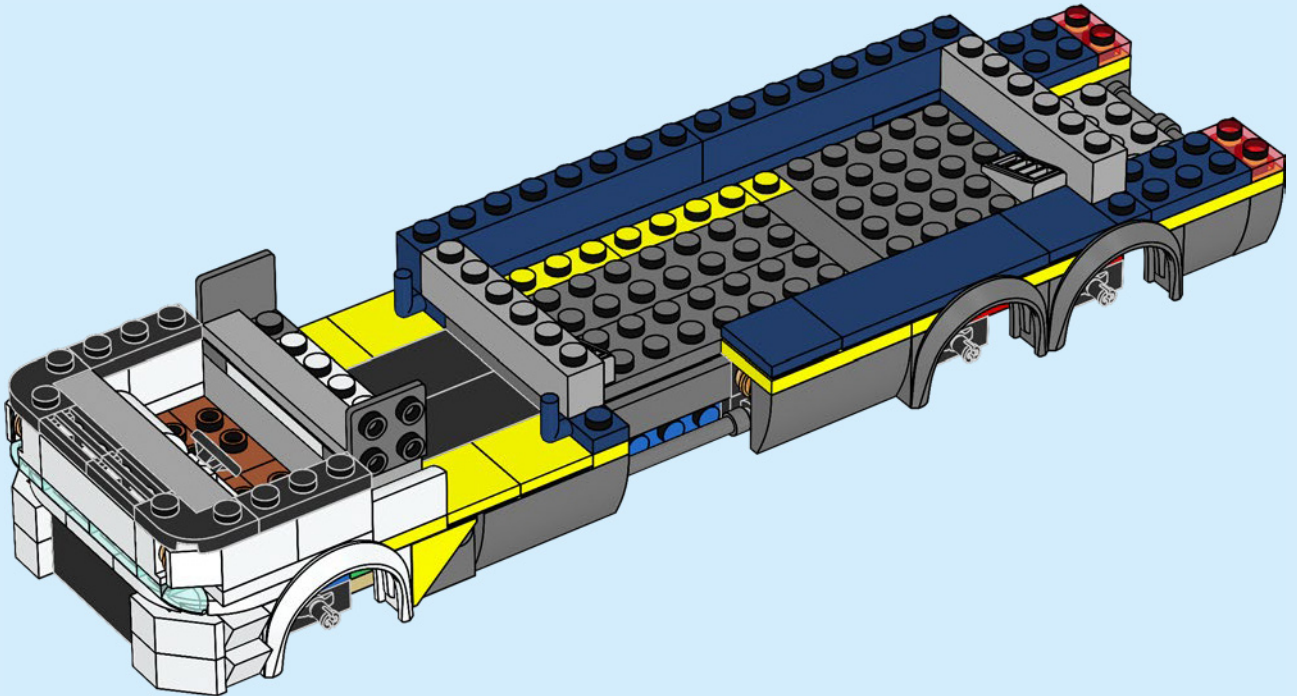

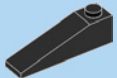

2x

63

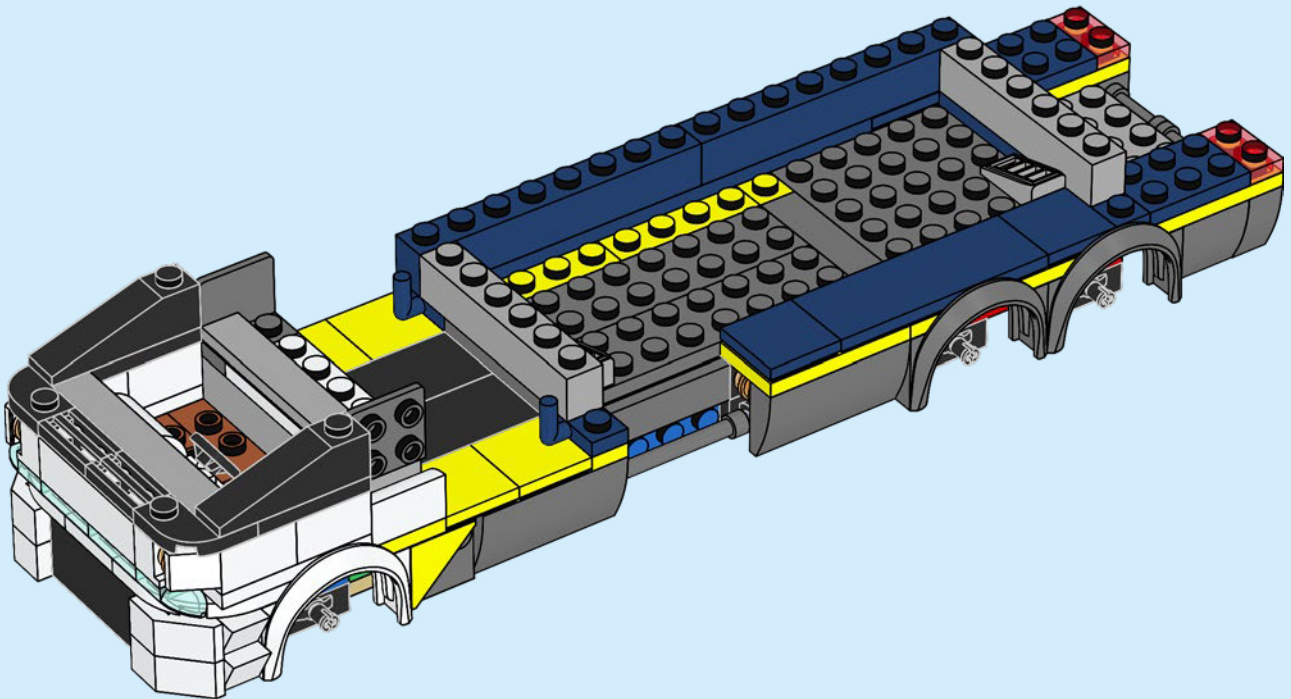



2x

64

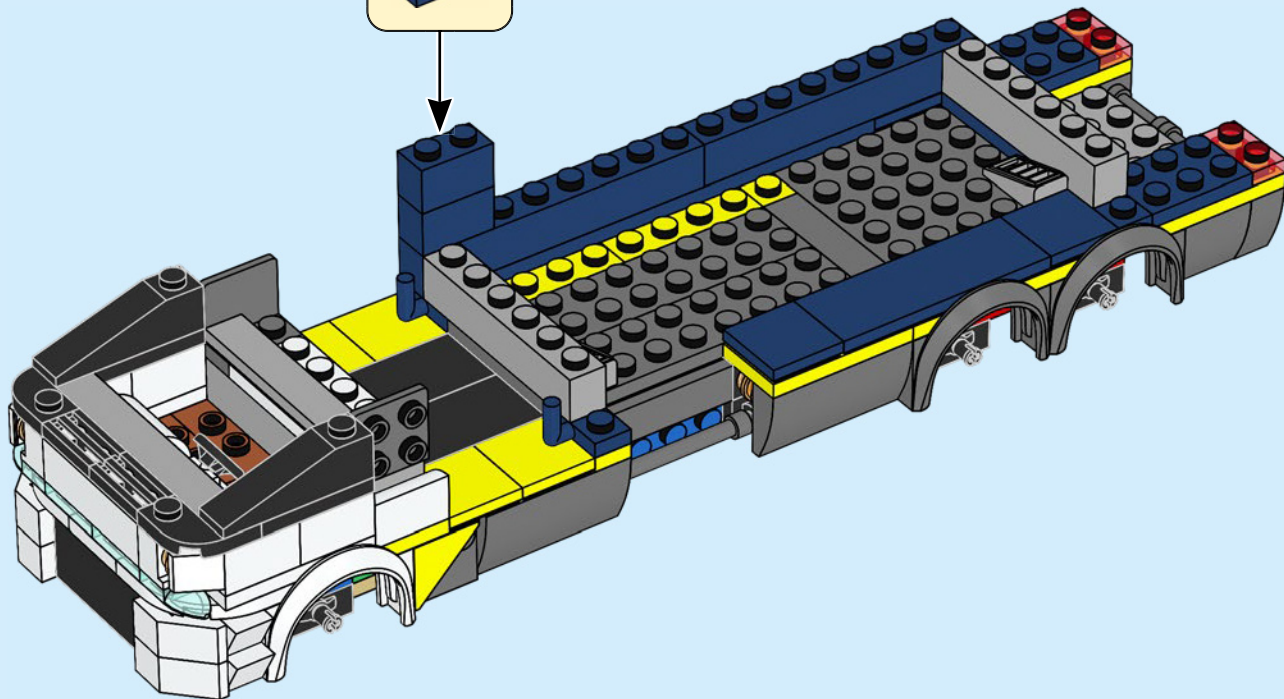
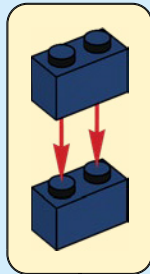



2x



2x

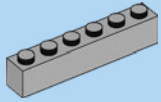

2x

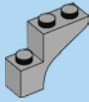

8x

65

1

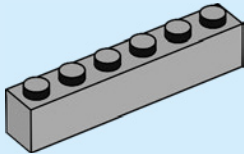

2

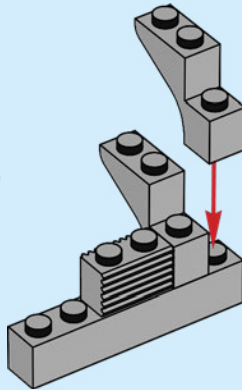

3

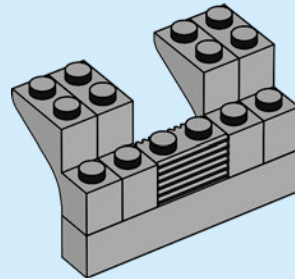

2x



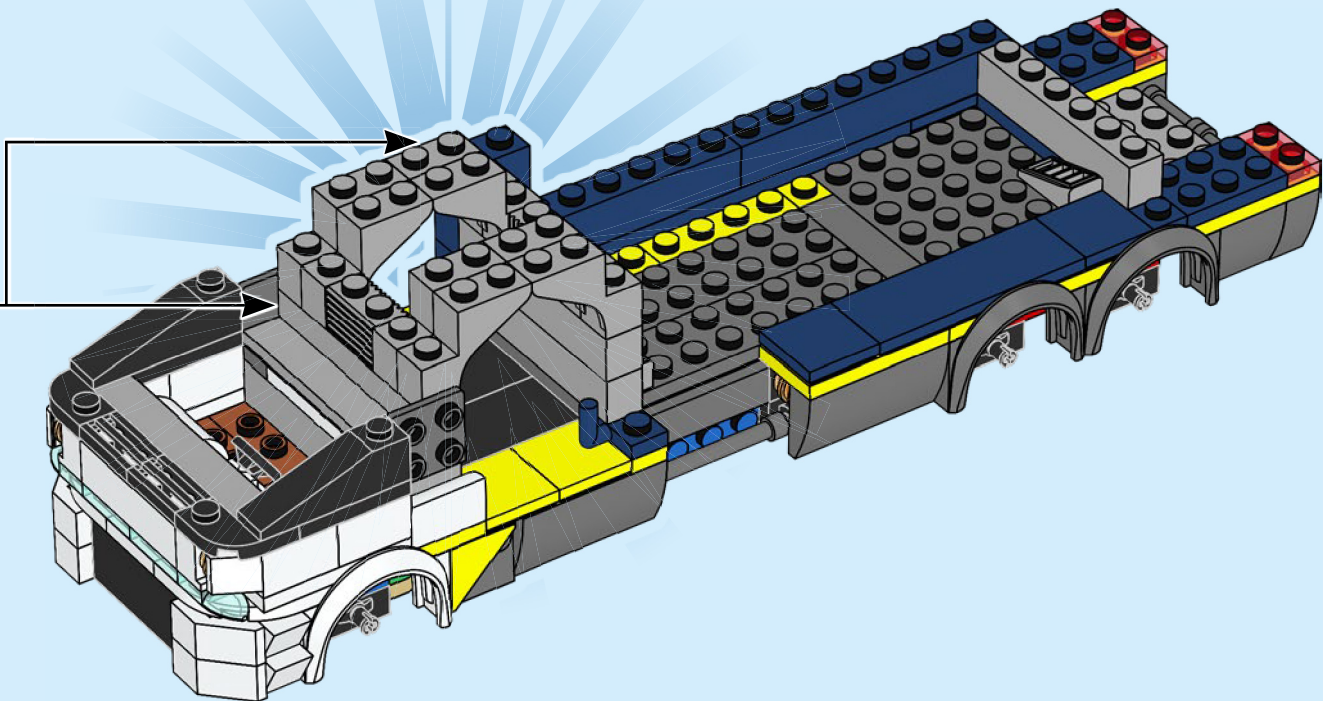



1x

66

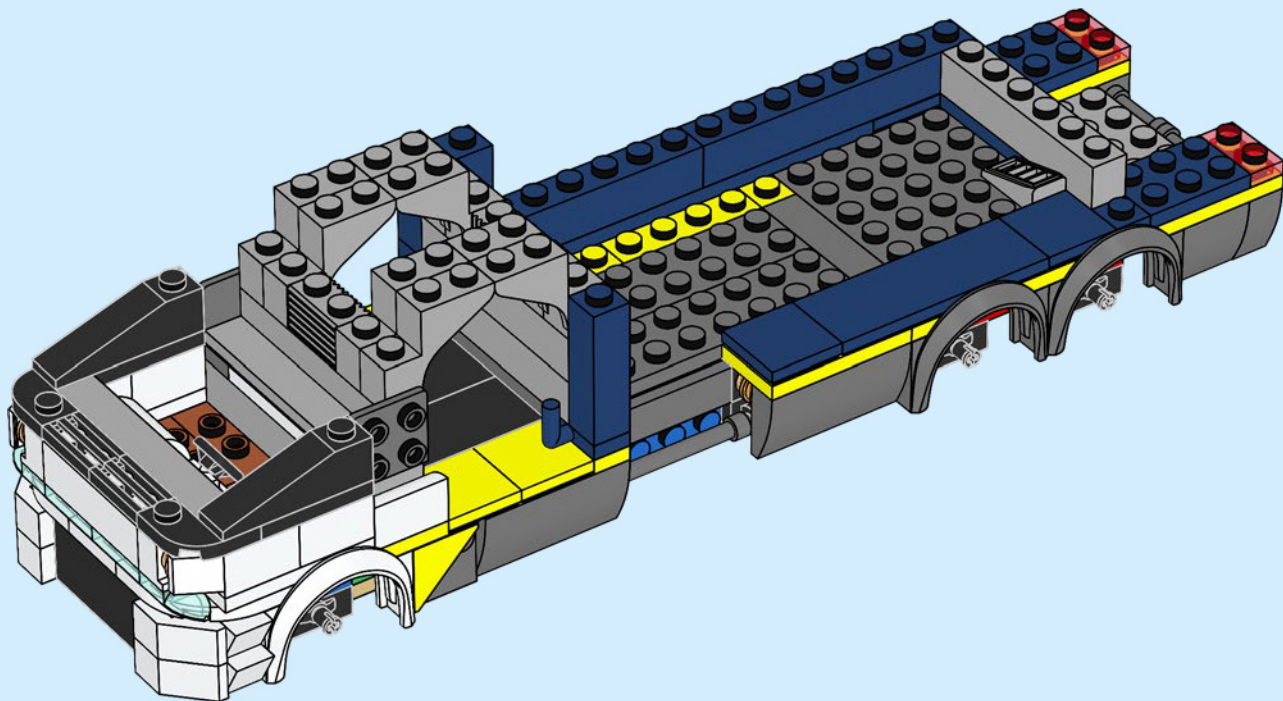

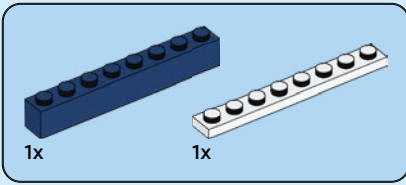

67

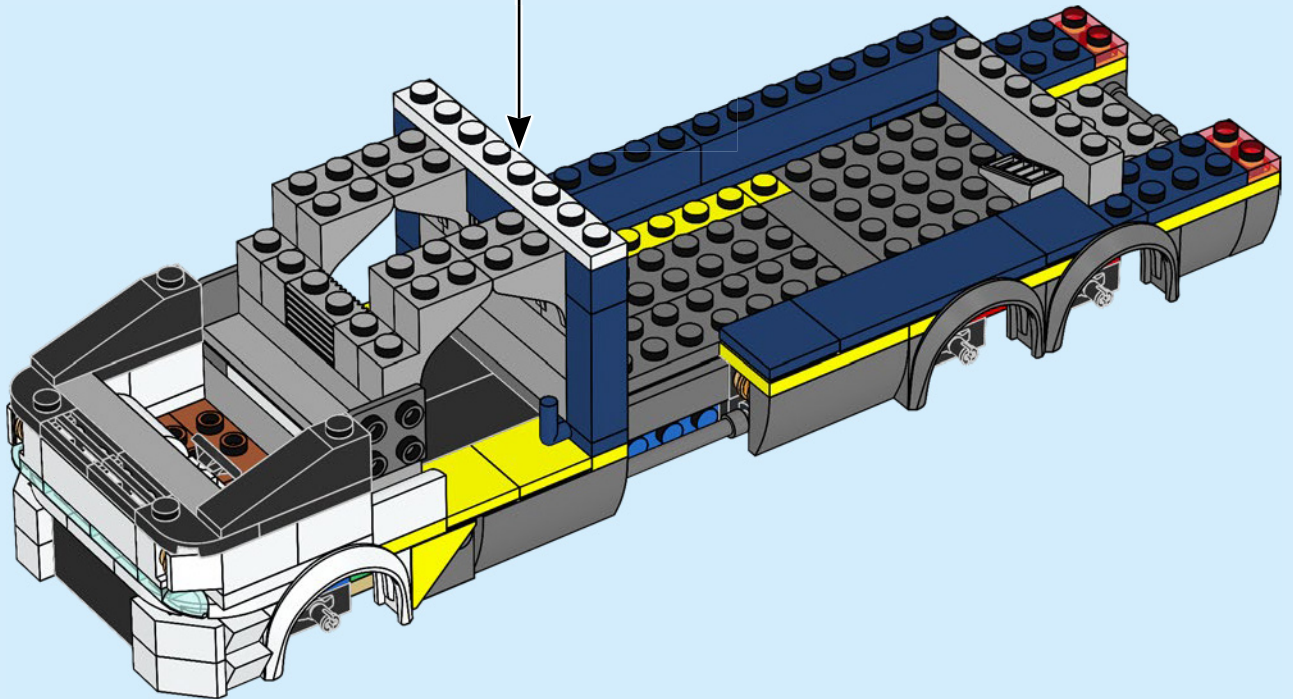
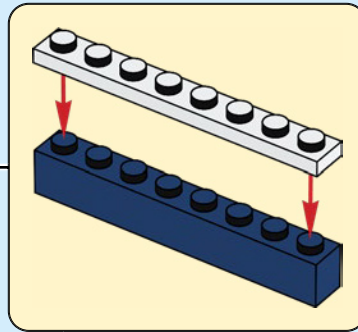



2x



2x



1x

68

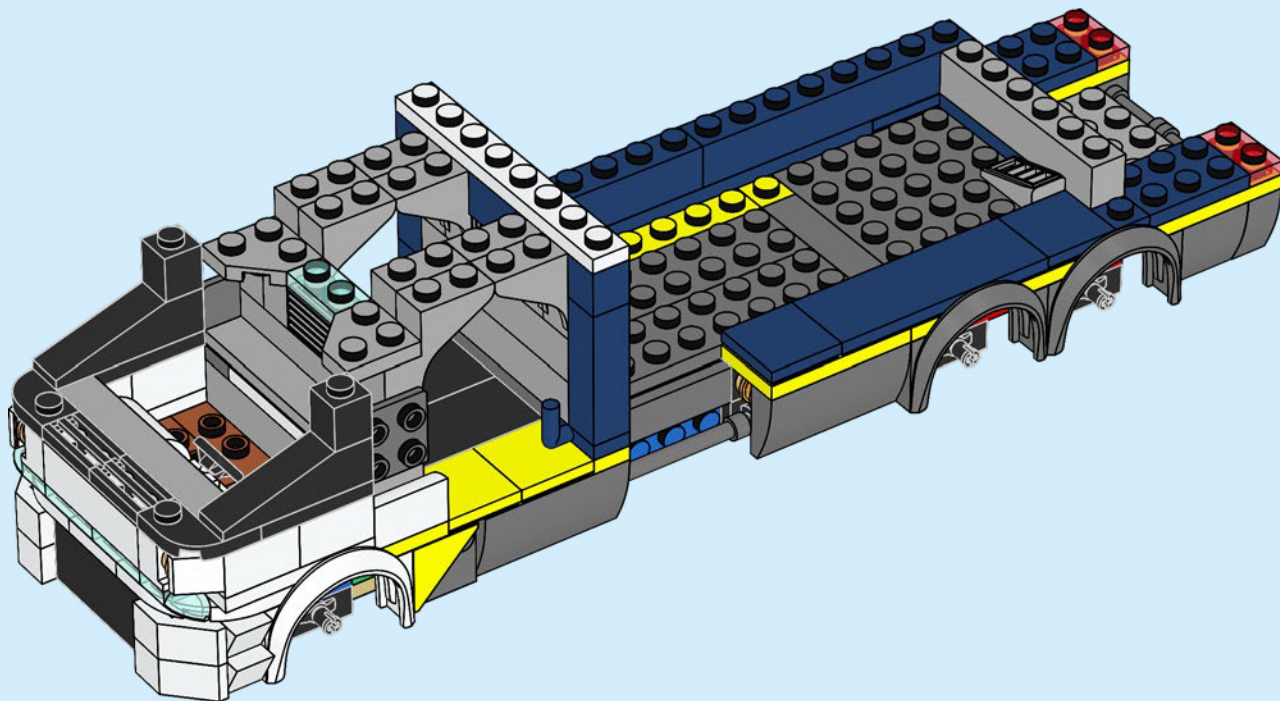

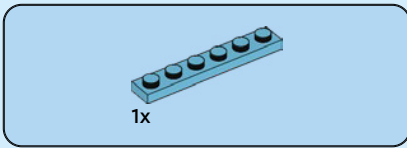

69

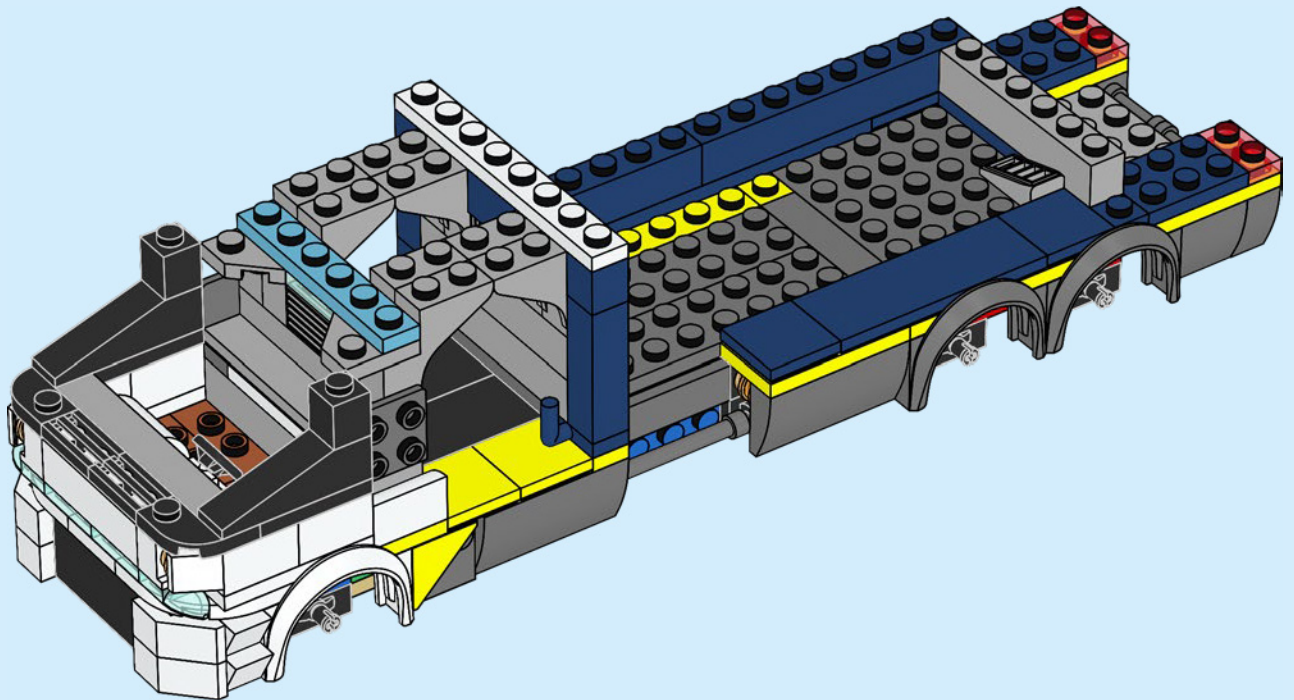



2x

70

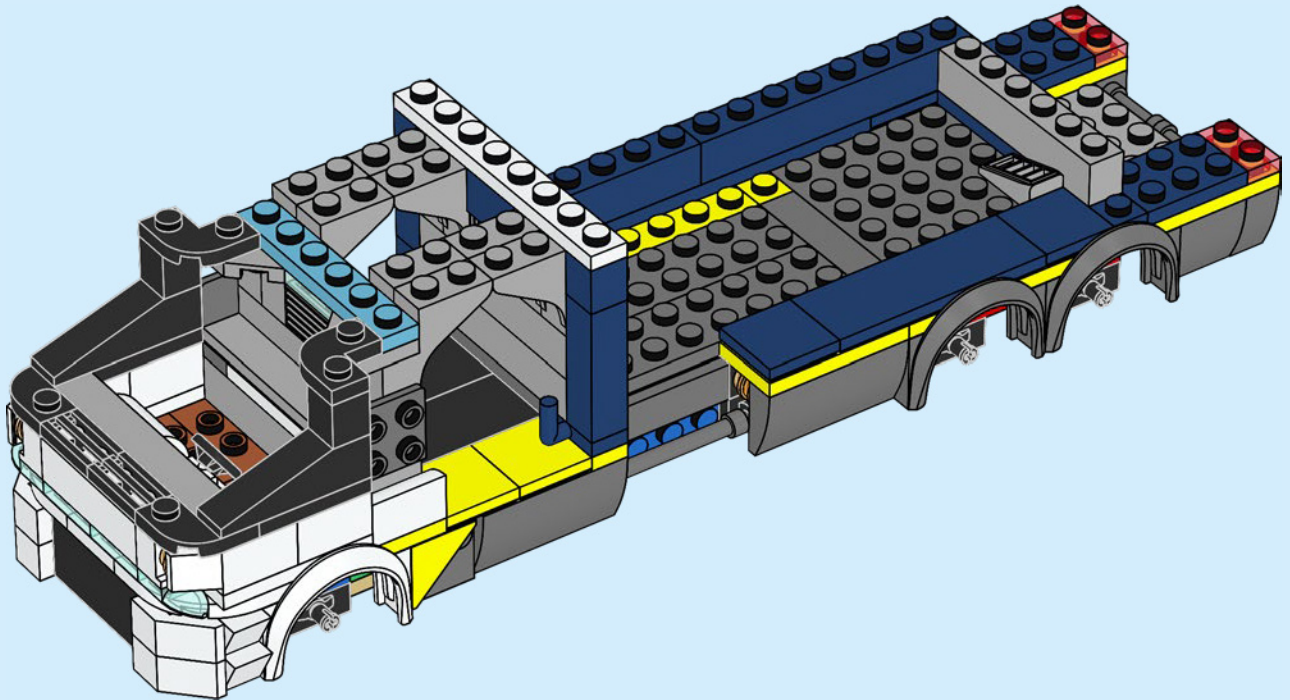



2x



2x

71

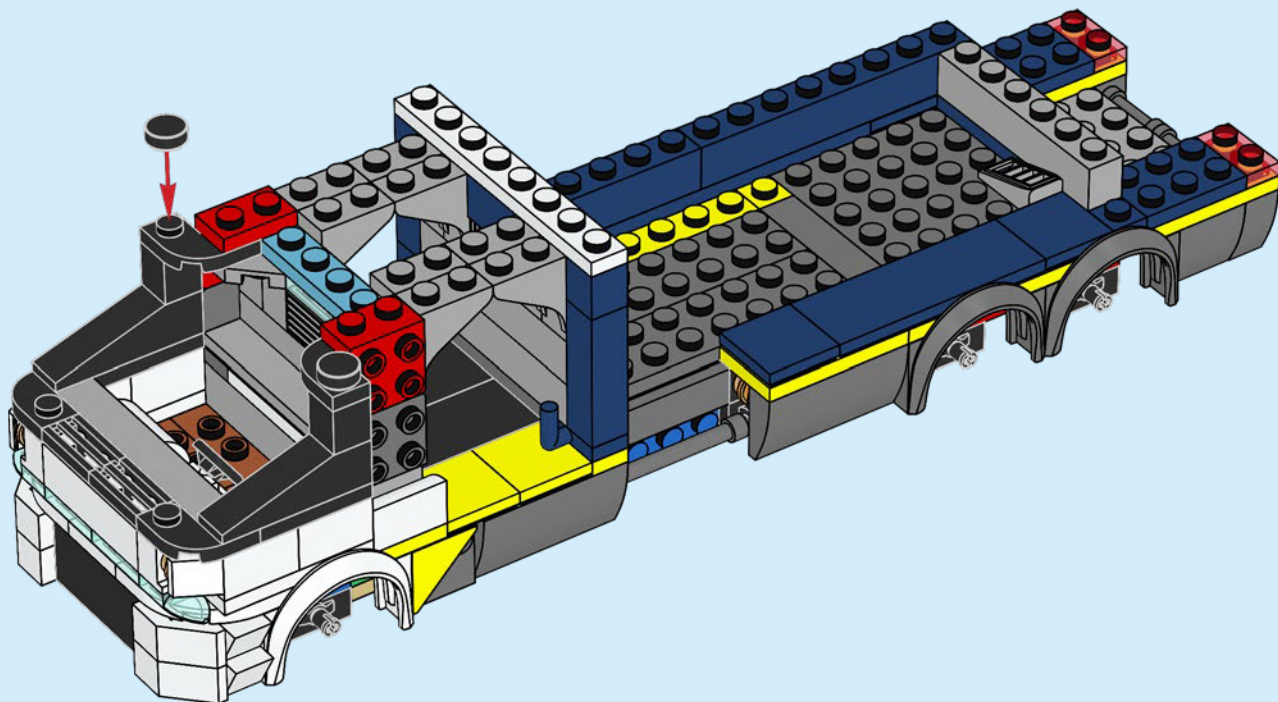

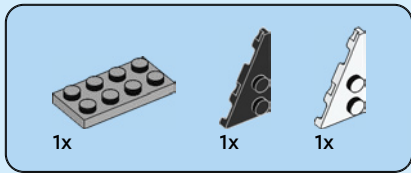

72

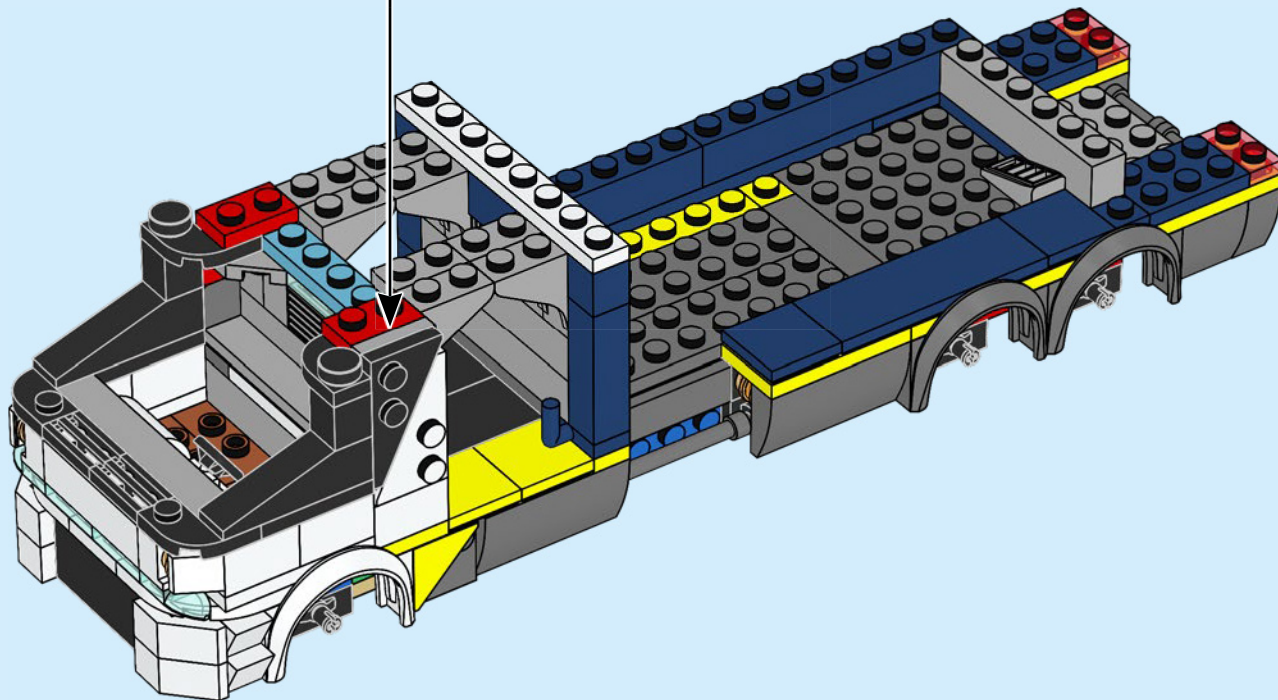
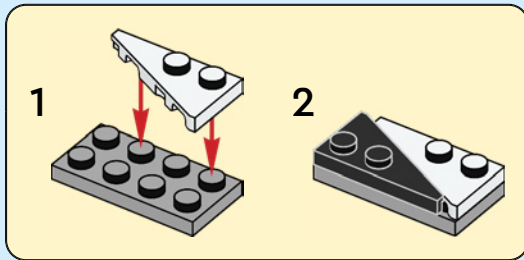

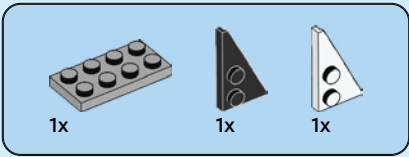

73

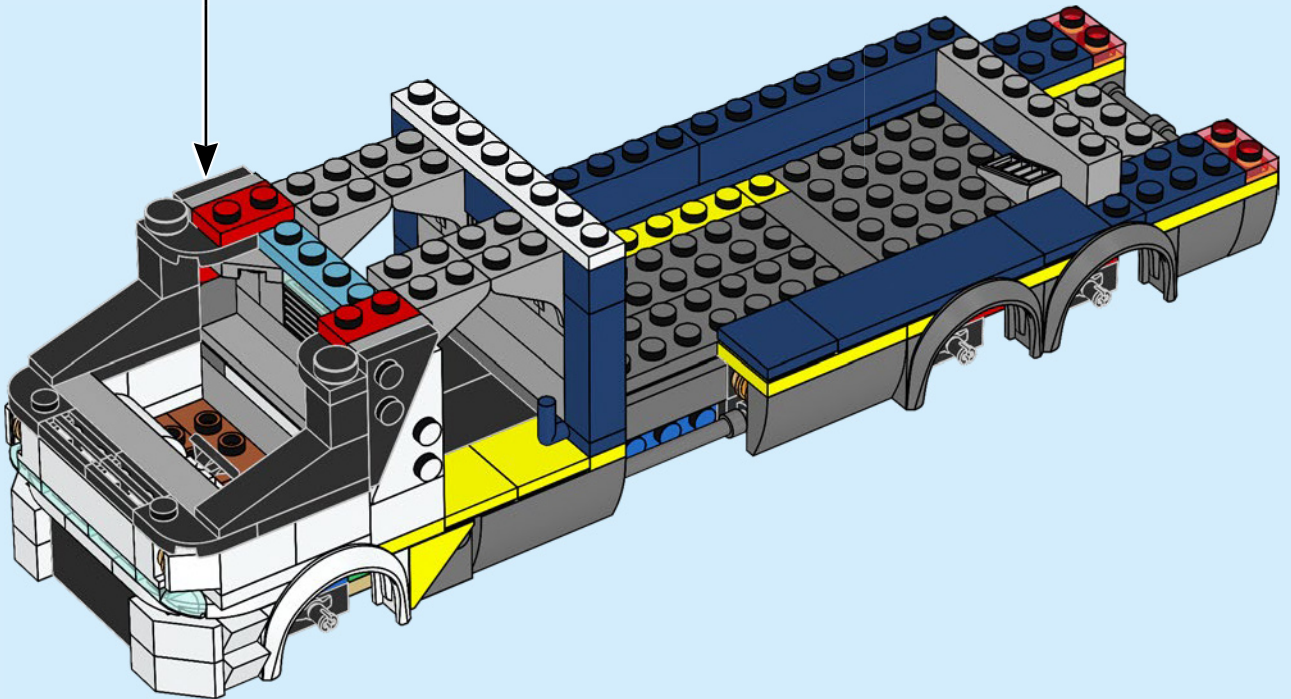
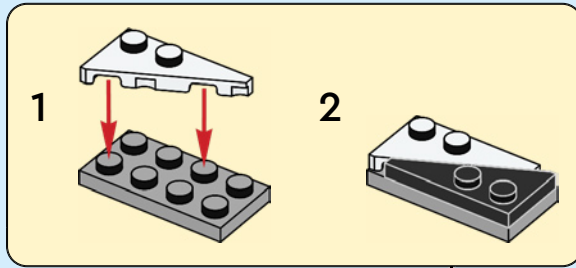



2x



4x

74

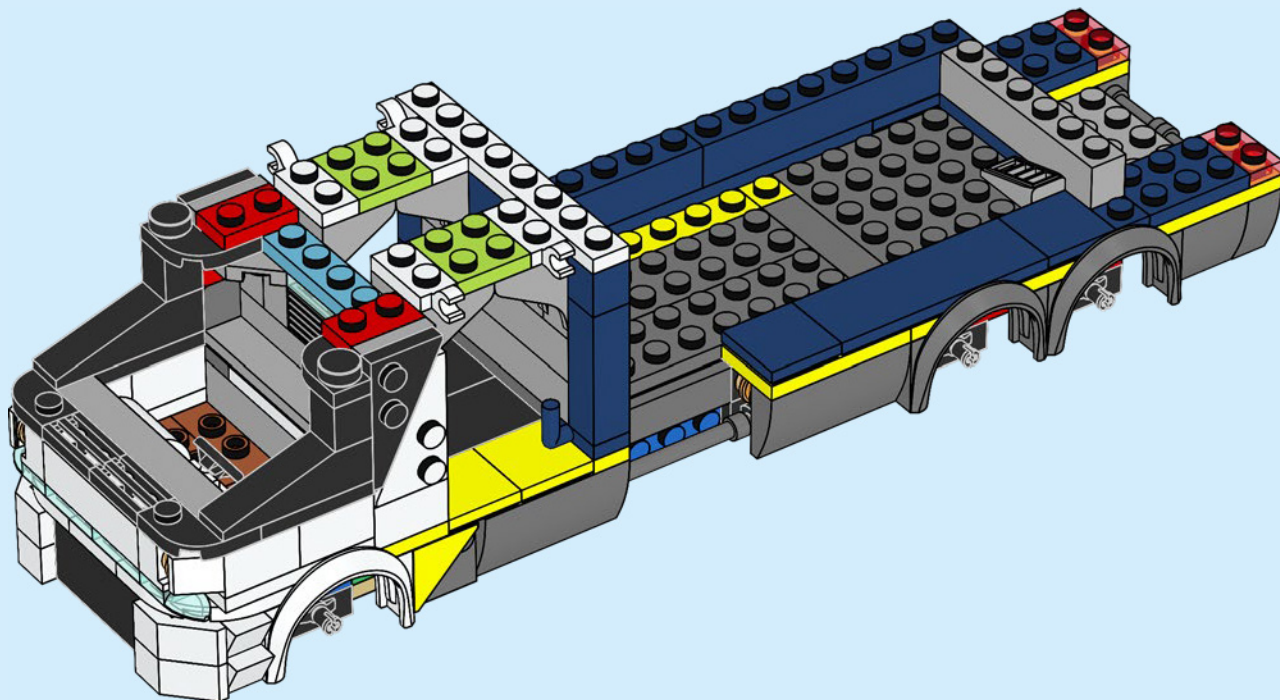

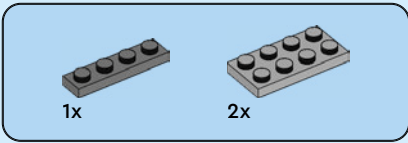

75

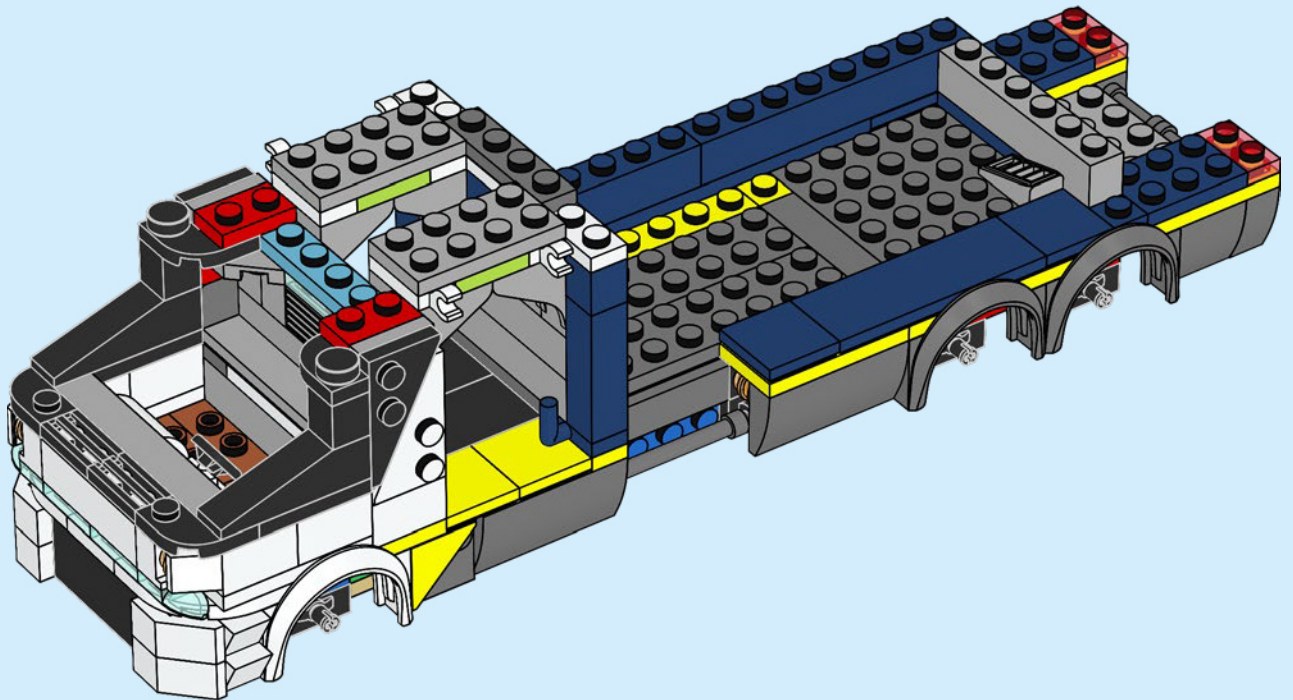

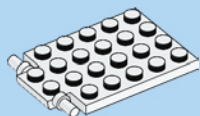
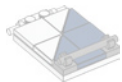

1x

76

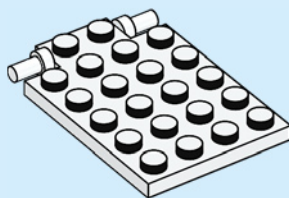

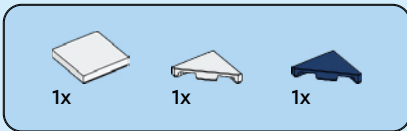

77

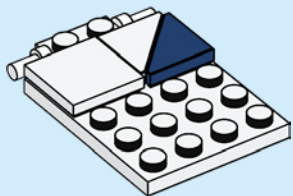

78

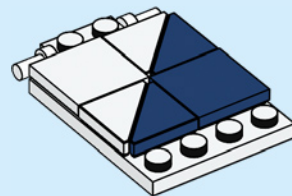



1x



2x

79

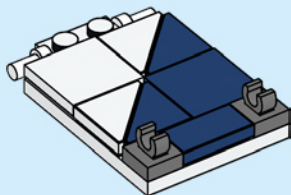

1x

80

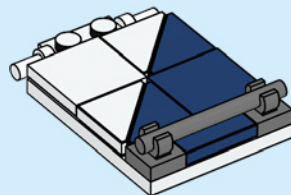

81

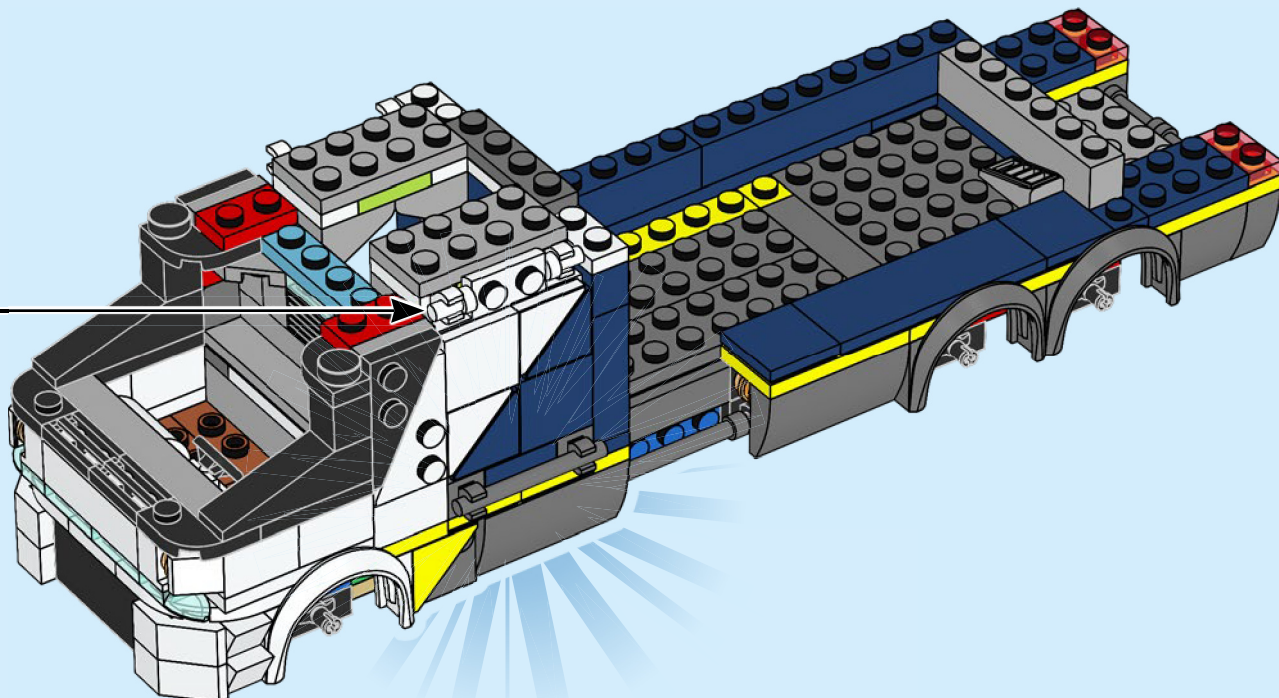

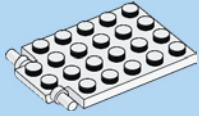
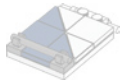

1x

82

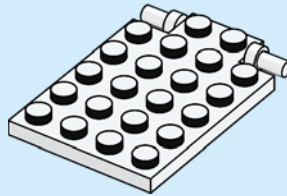



83

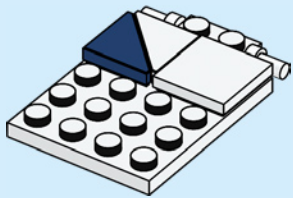

84

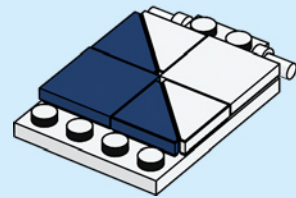

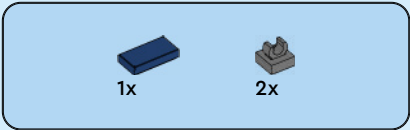

85

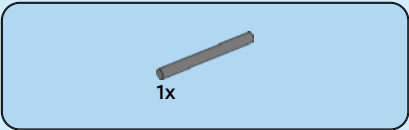
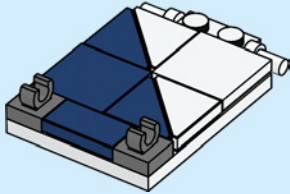

86

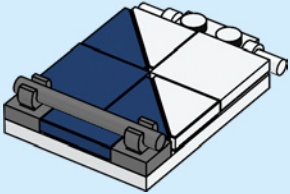

87

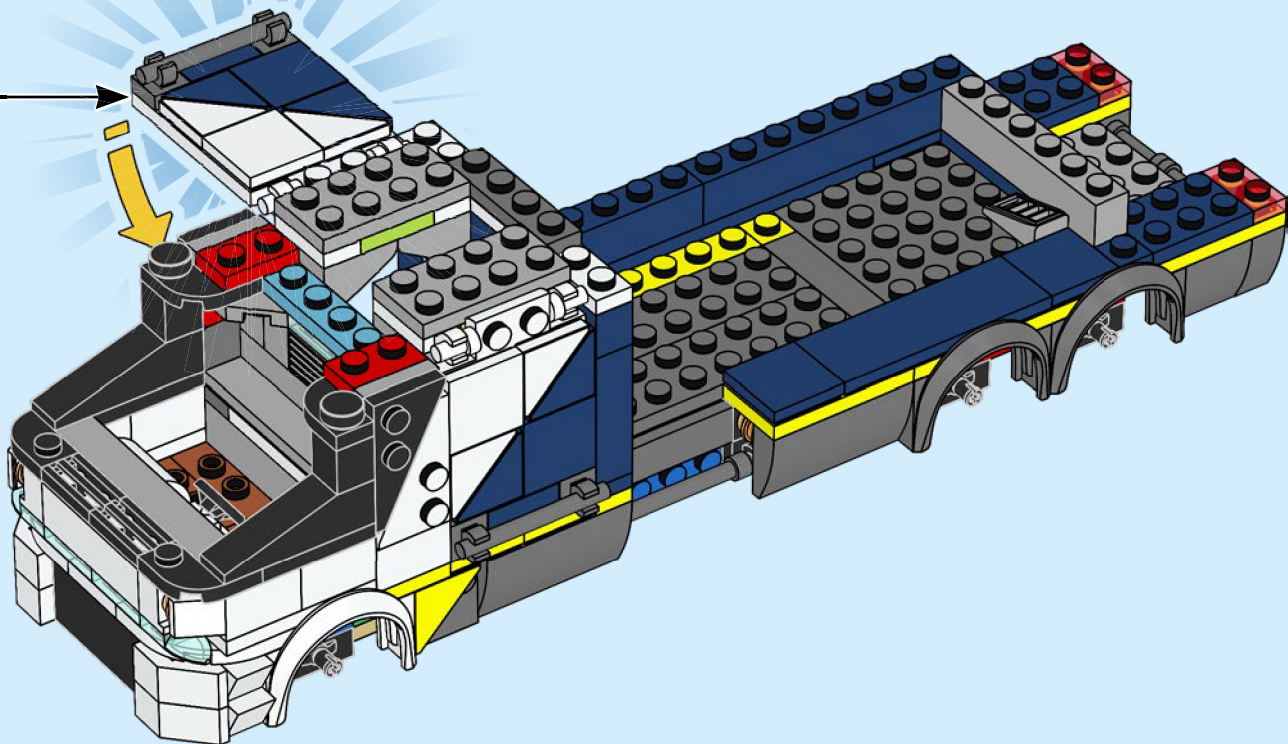

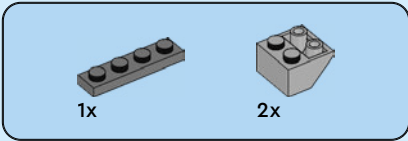

88

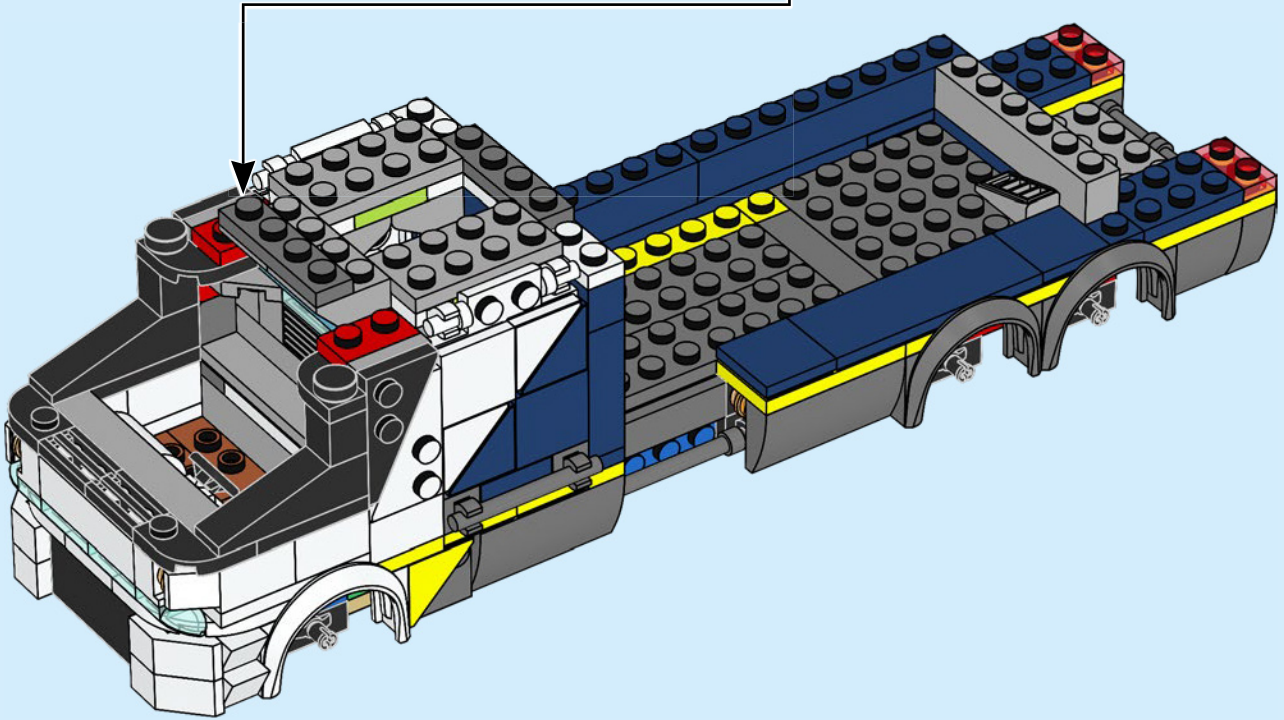
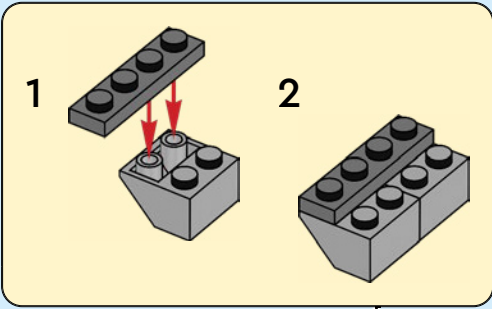



2x



4x

89

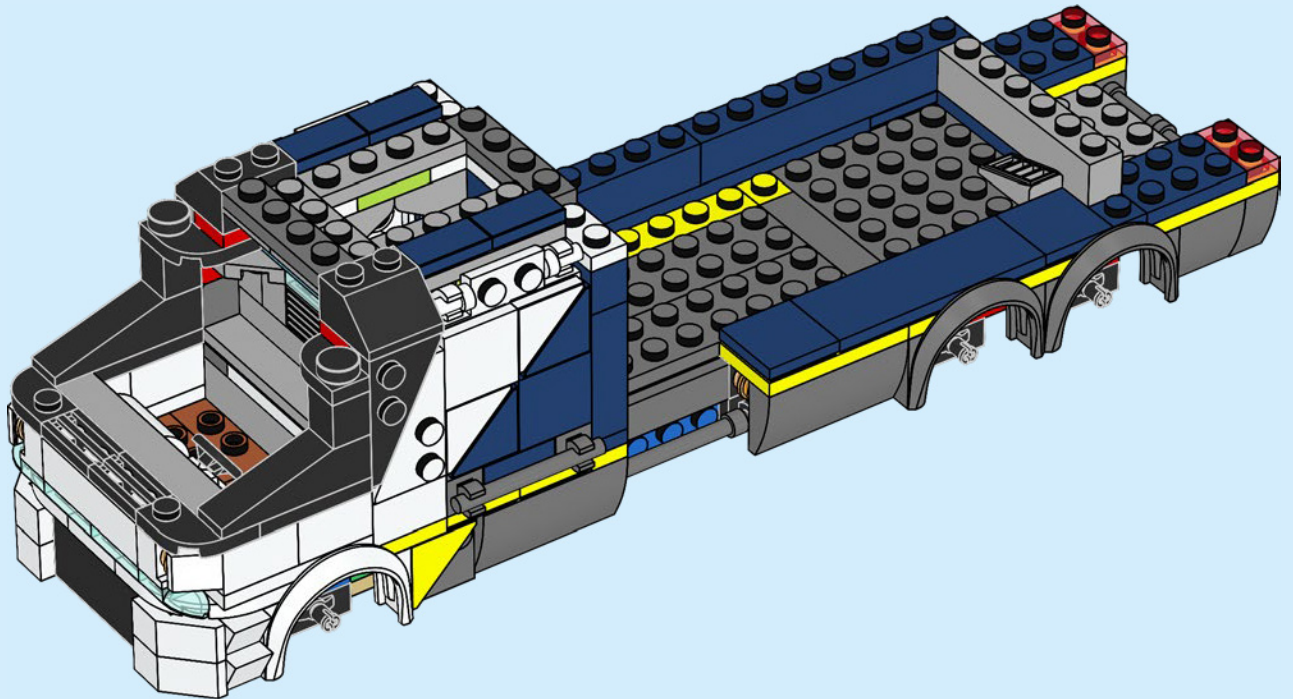

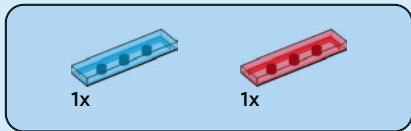

90

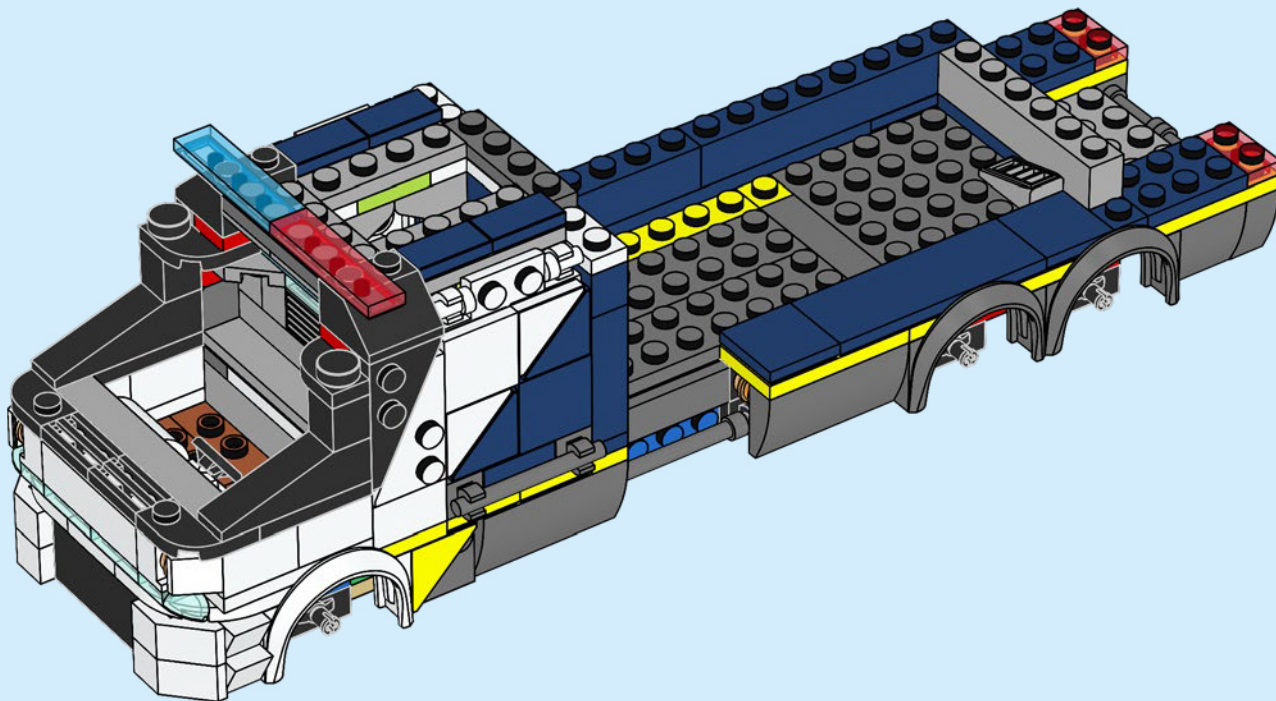

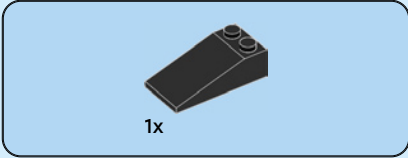

91

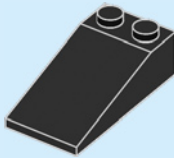

92

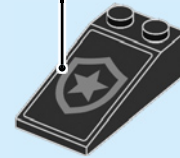

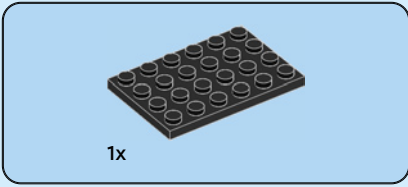

93

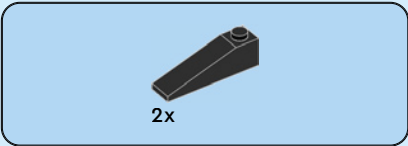
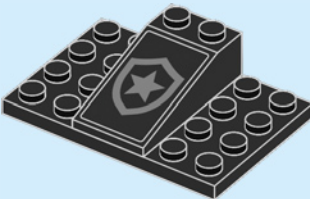

94

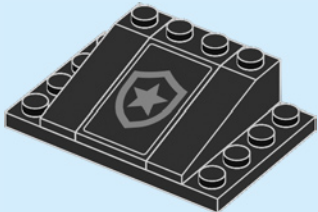

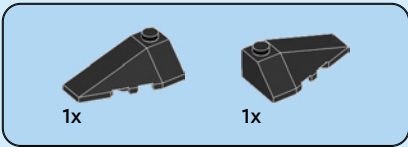

95

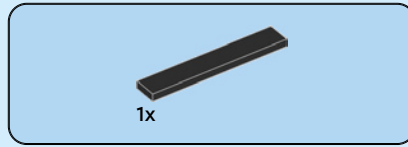
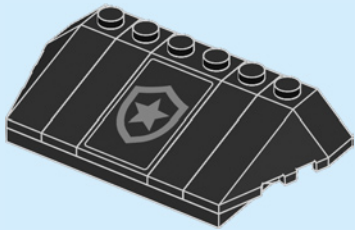

96

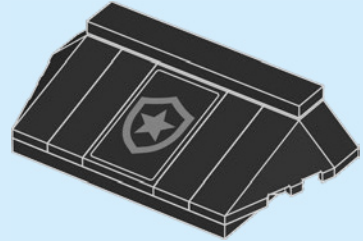



3x

97

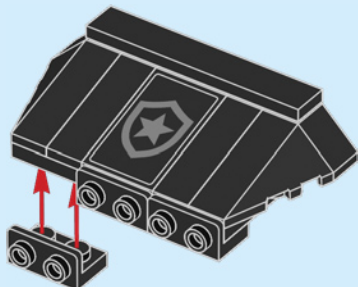

3x

98

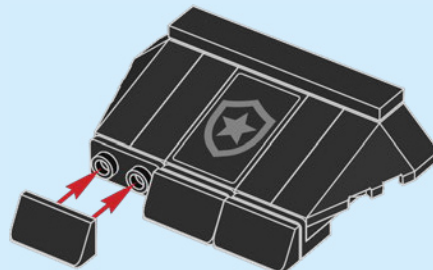

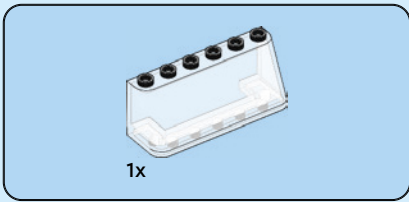

99

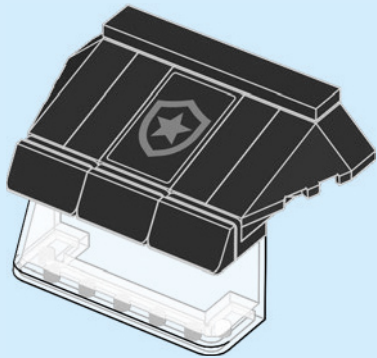

100

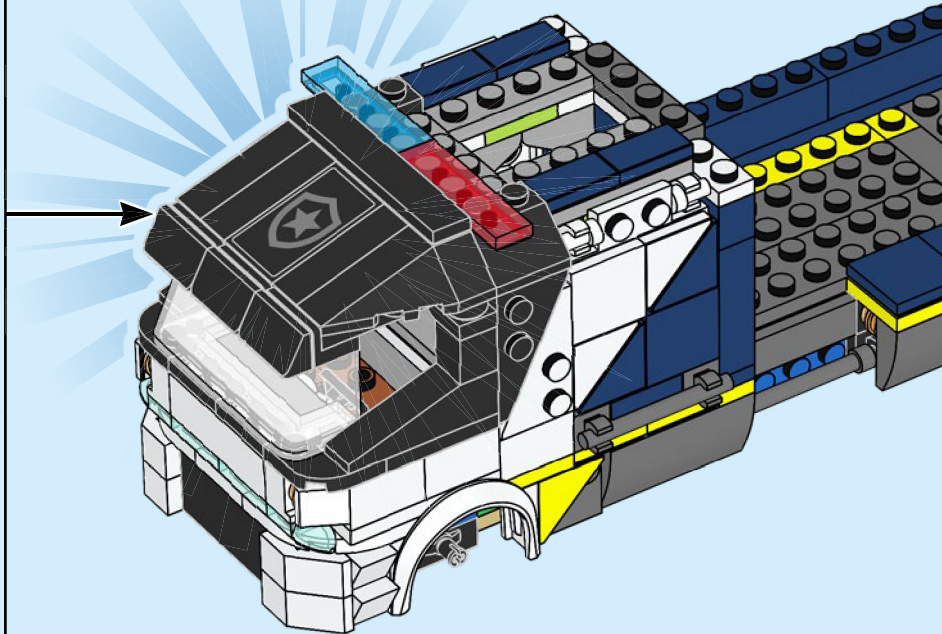

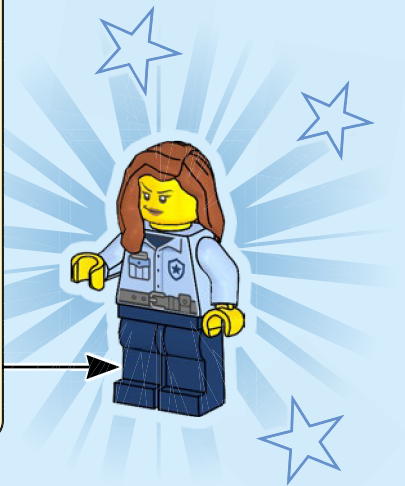
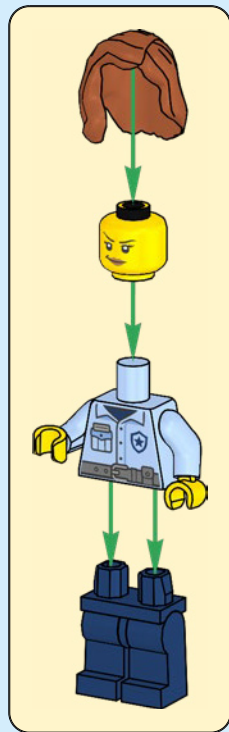

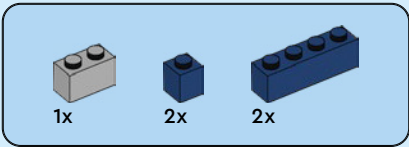

101

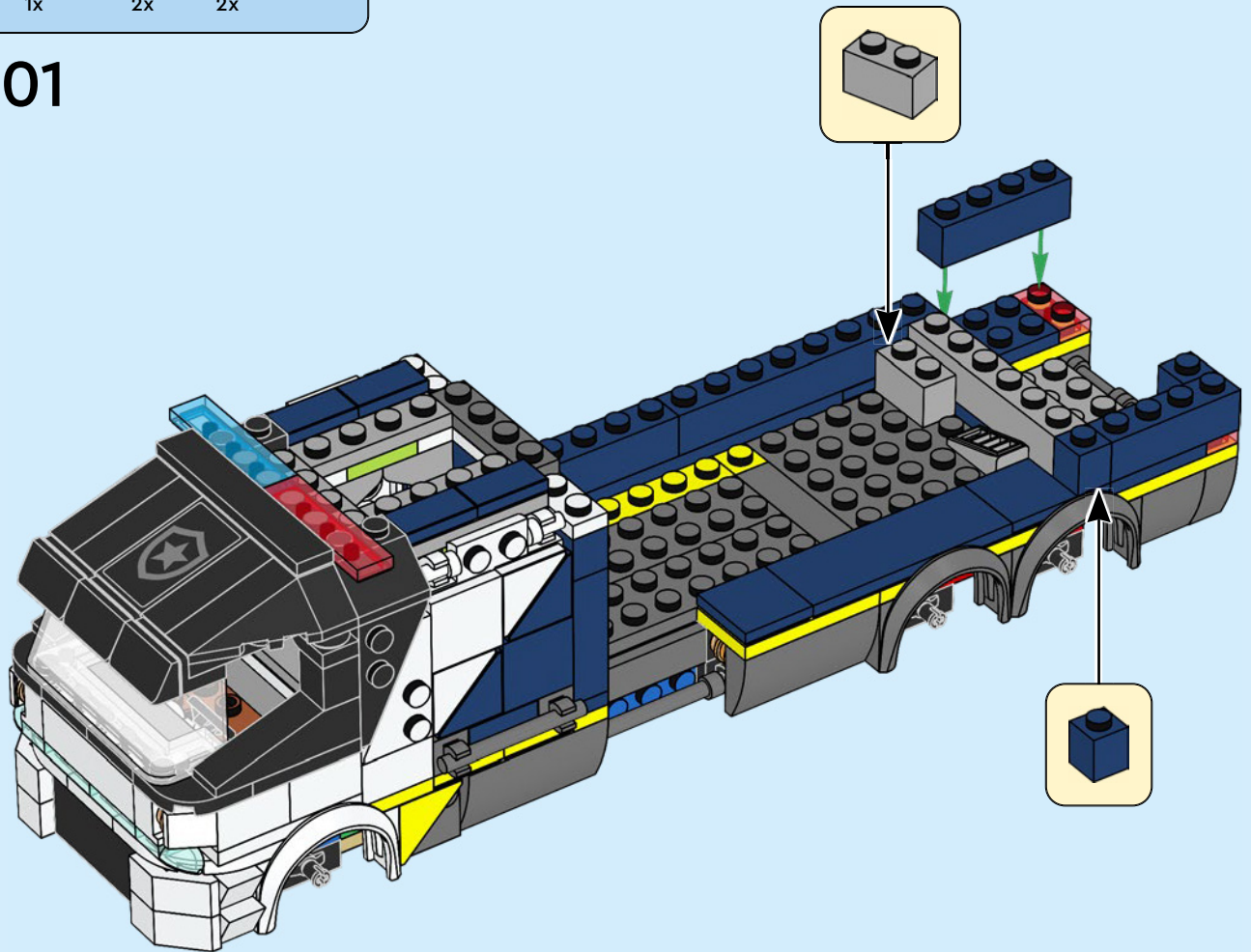



1x



1x

102

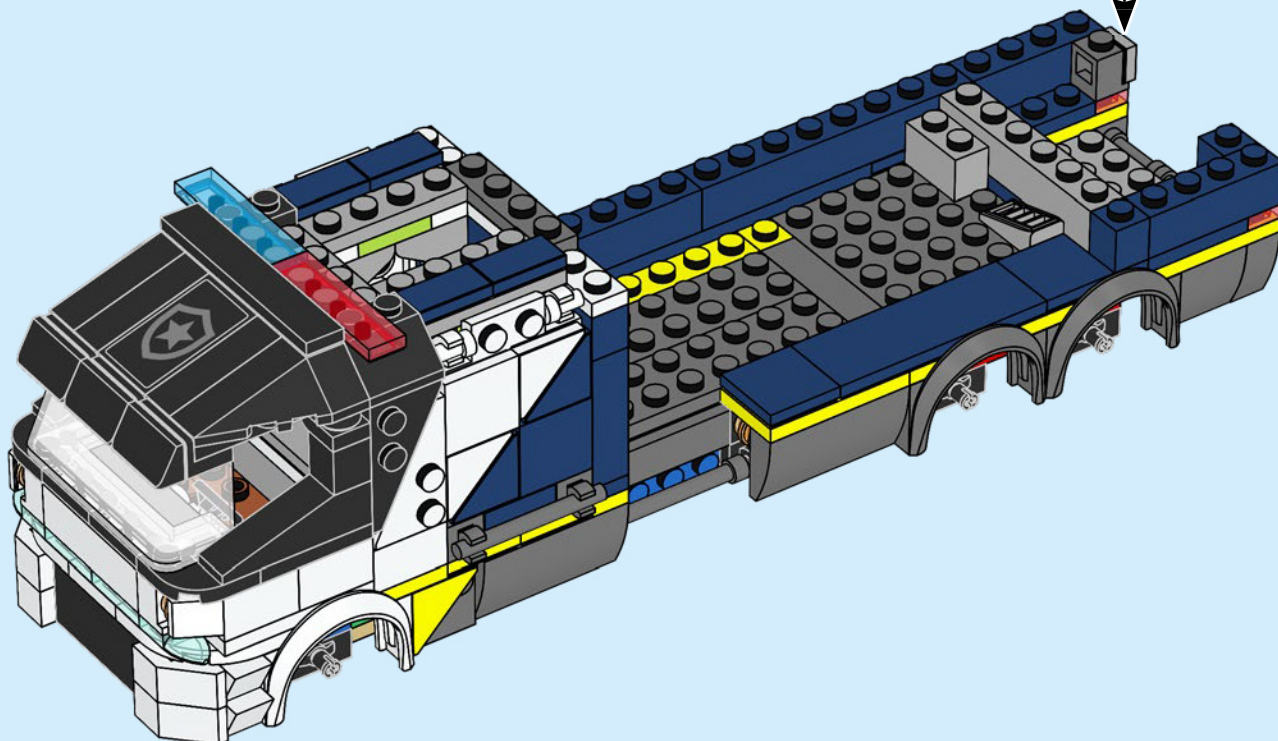
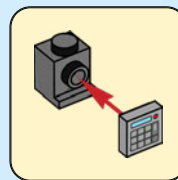



2x



2x

103

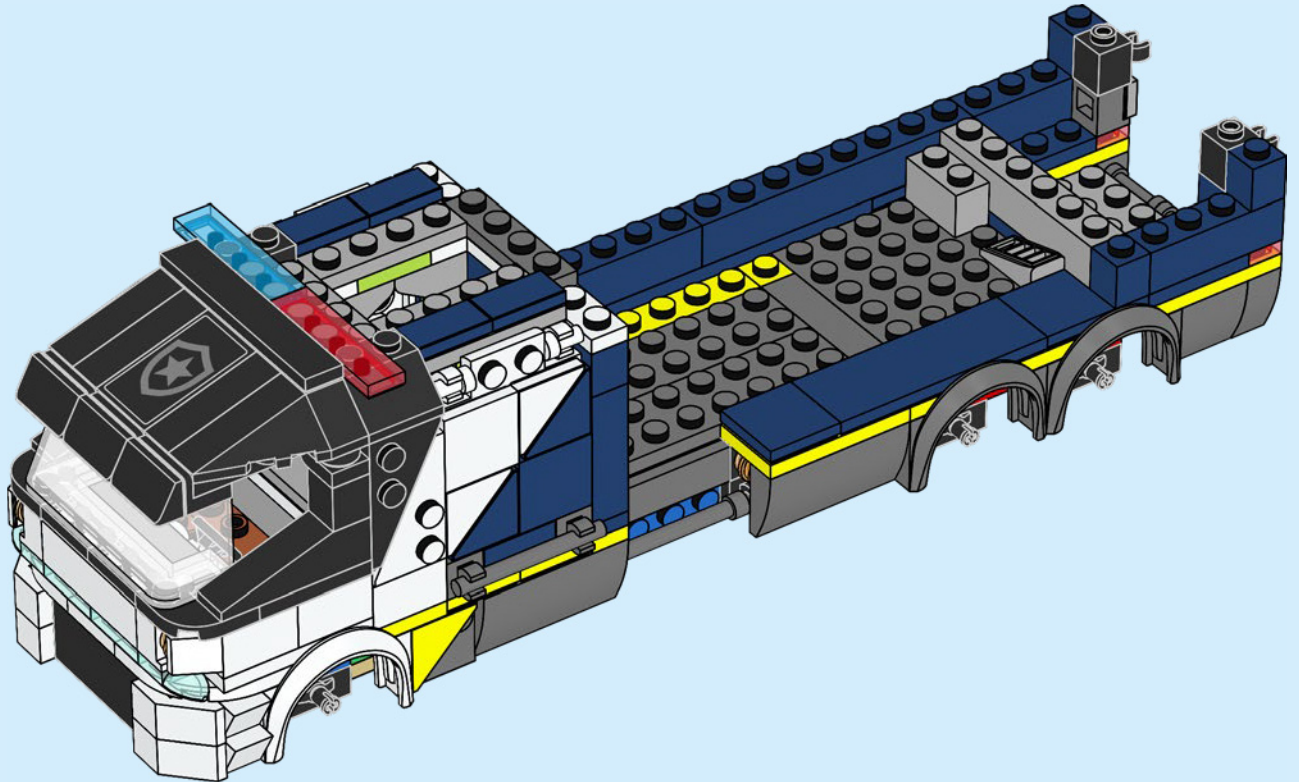

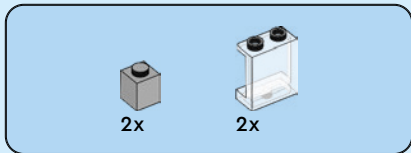

104

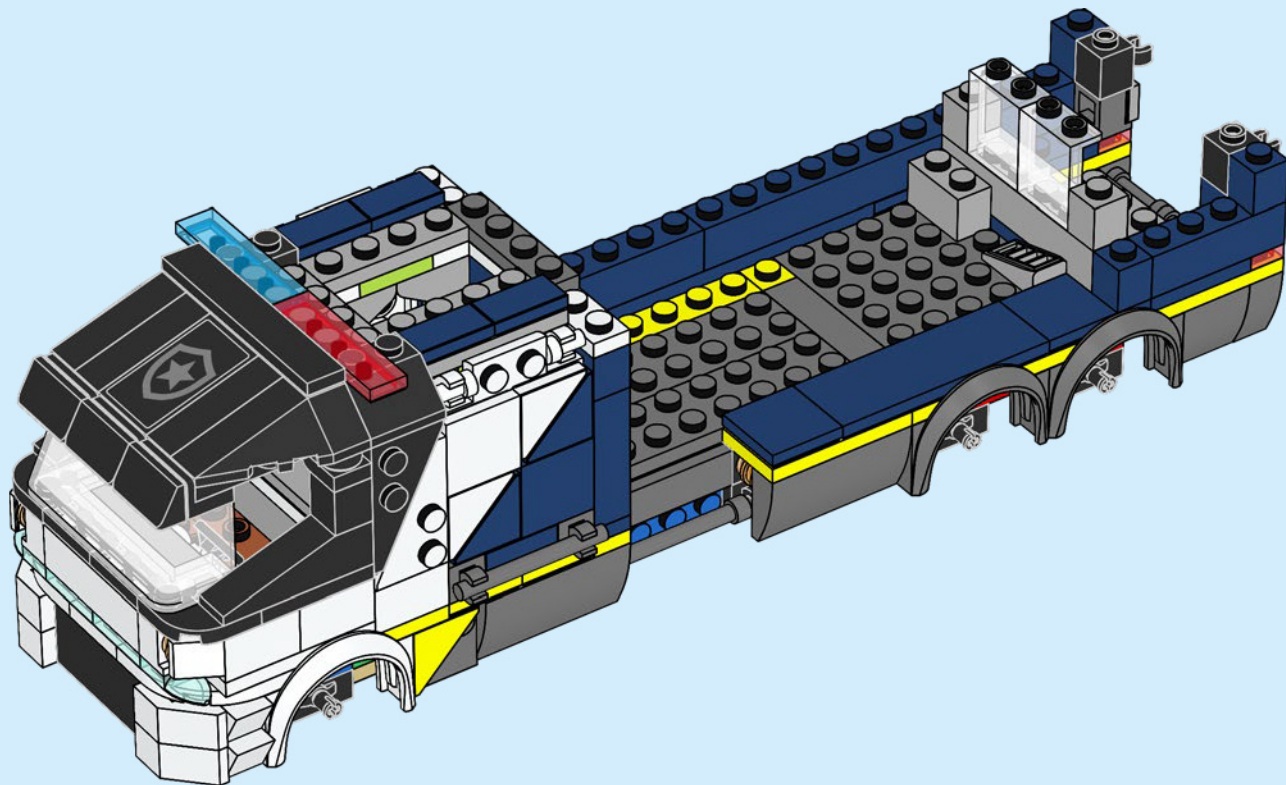



2x



2x

105

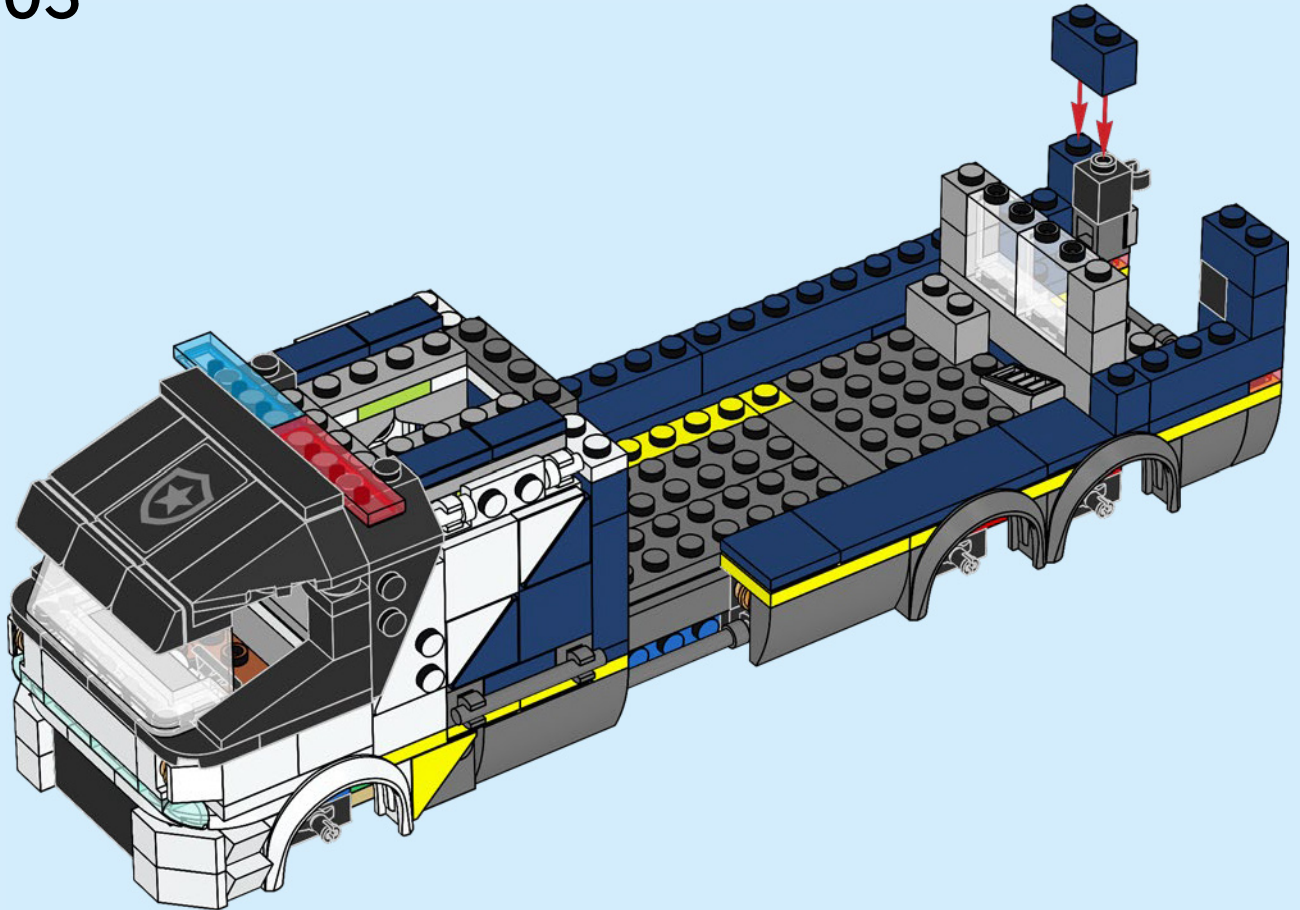

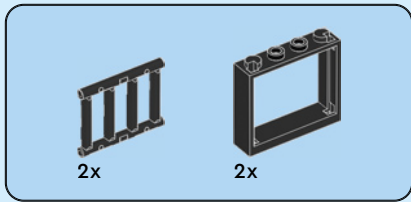

106

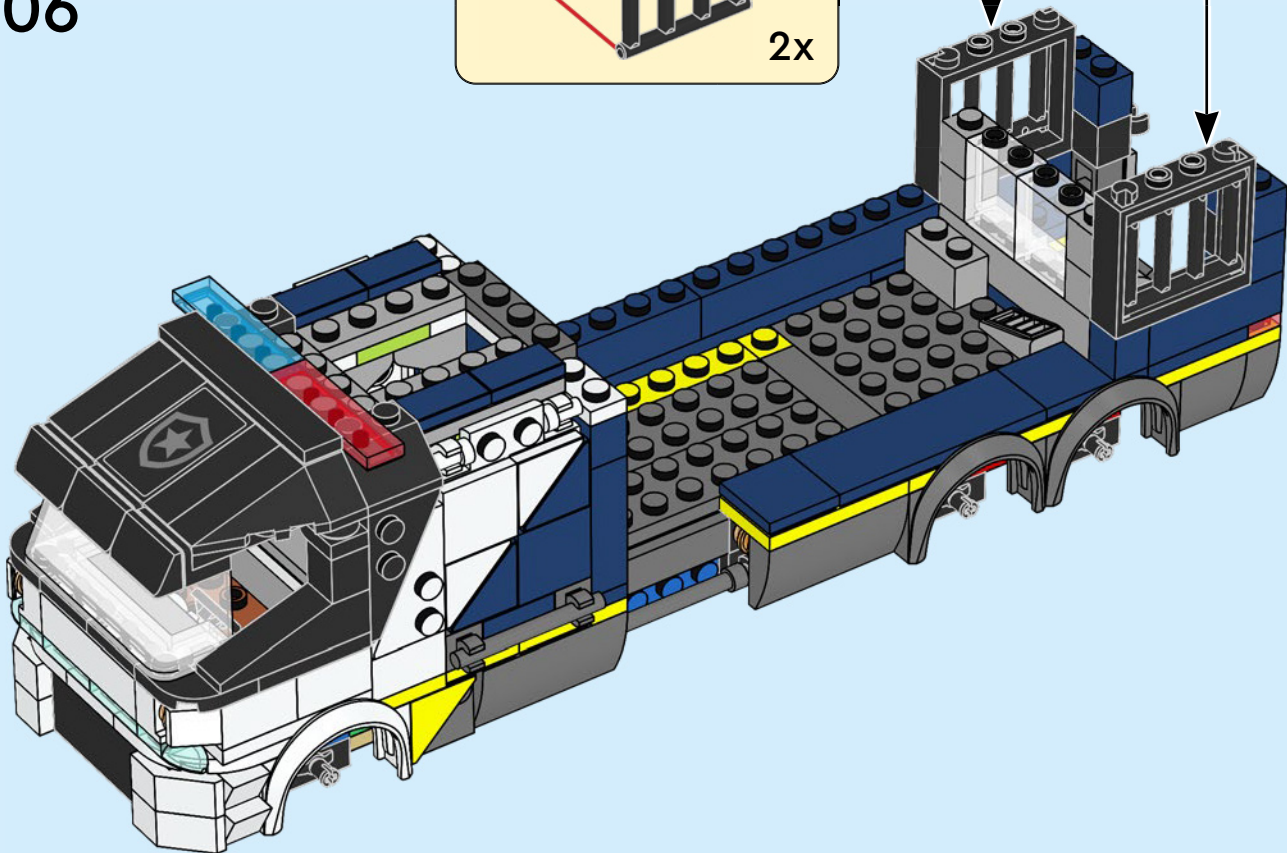
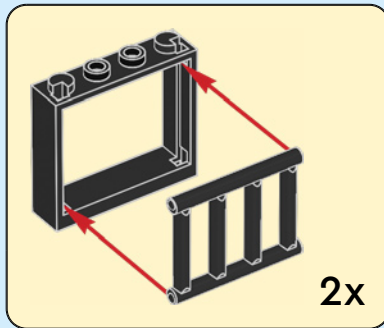



2x



2x

107

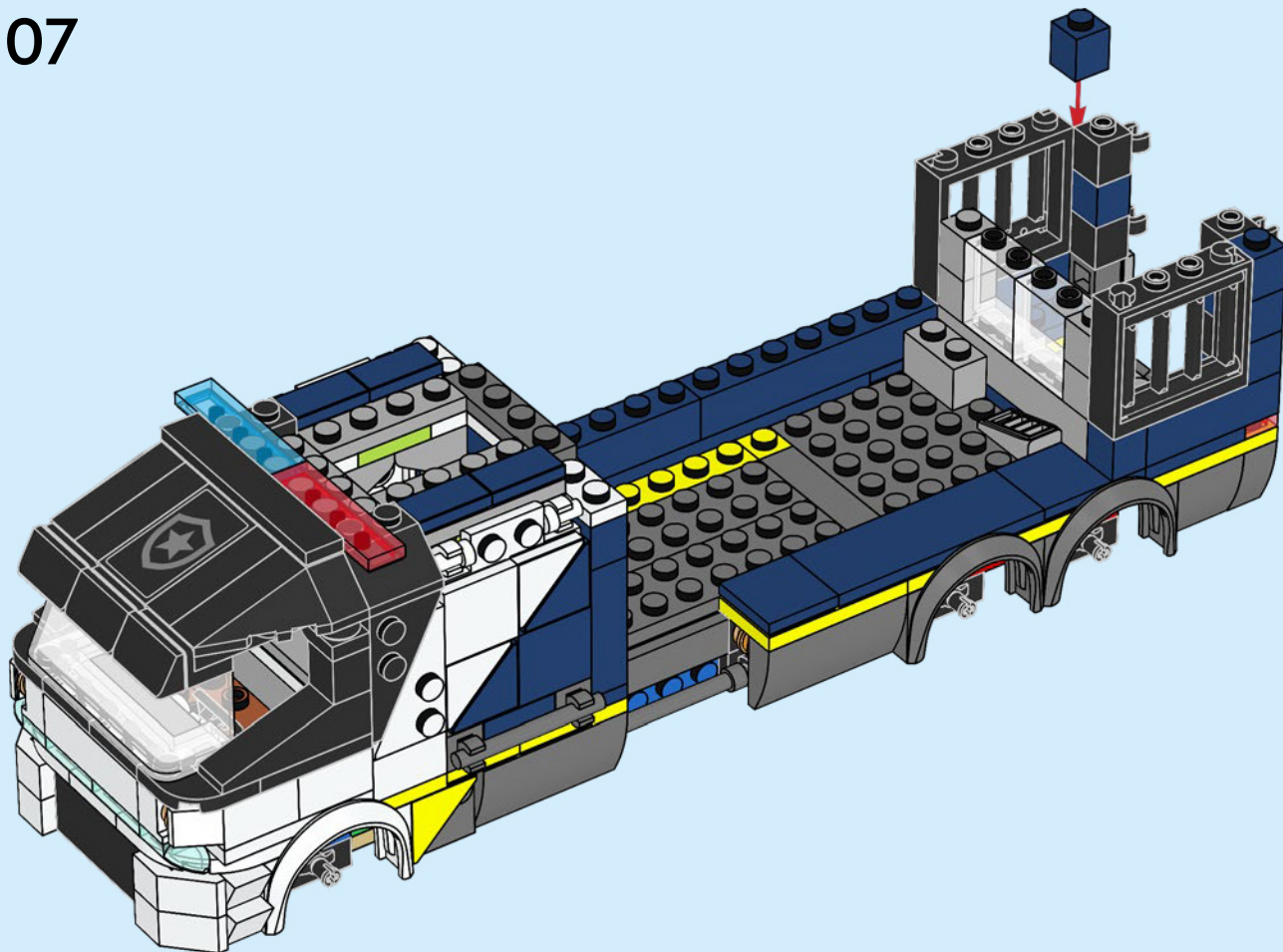



2x

108

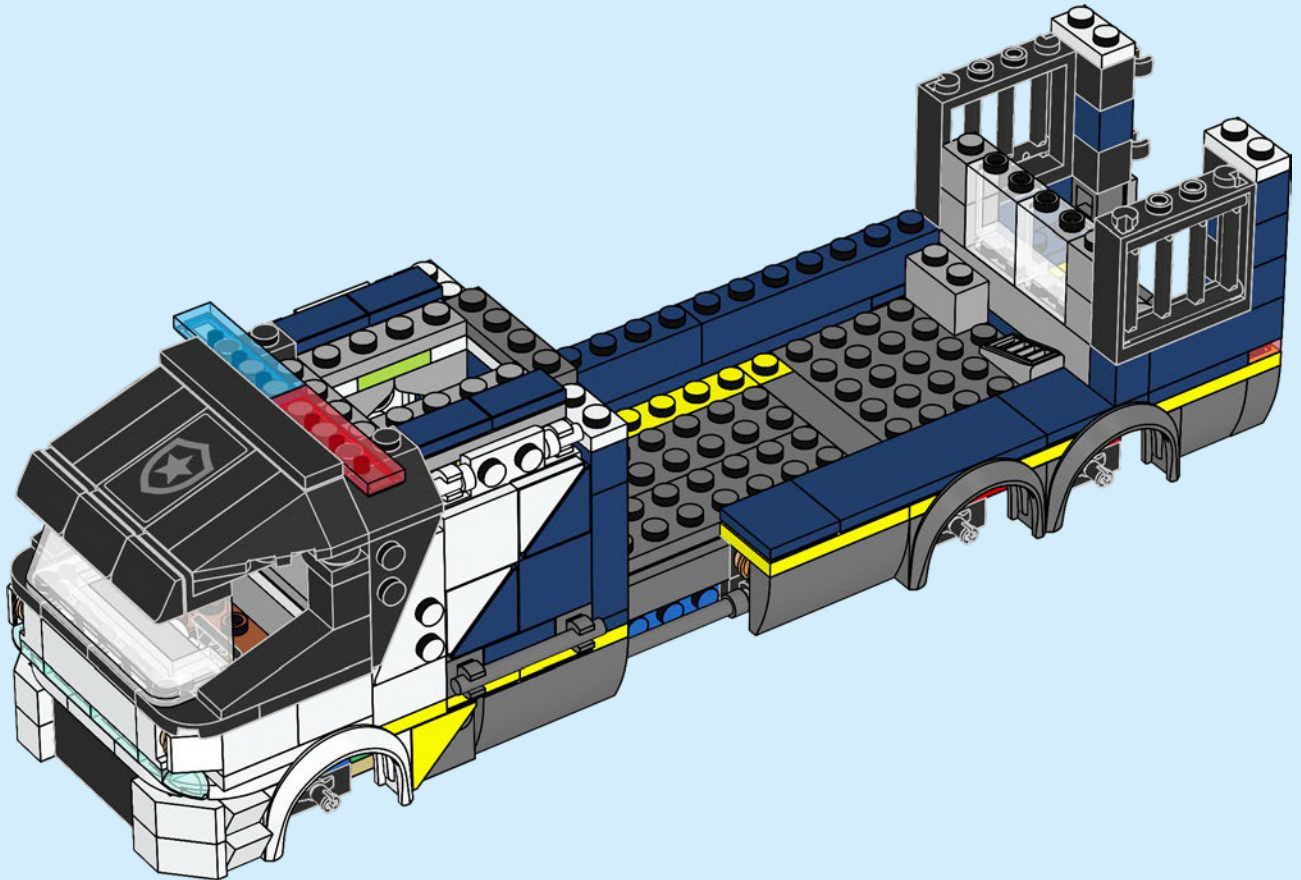

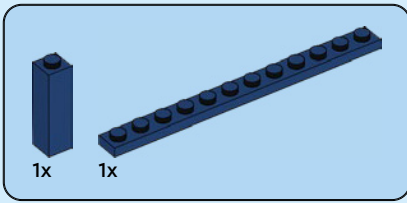

109

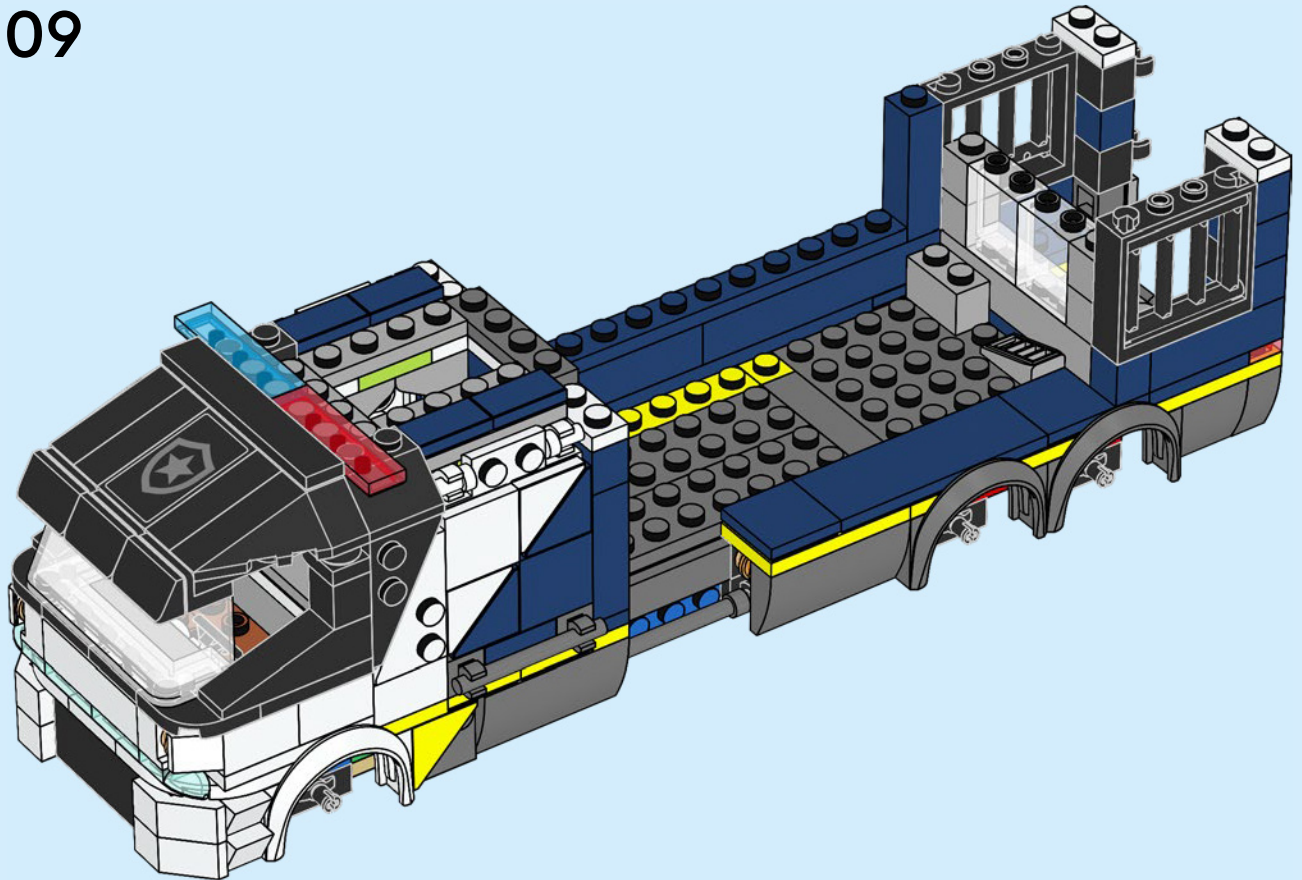

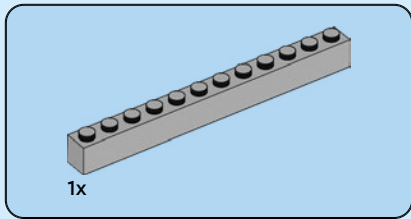

110

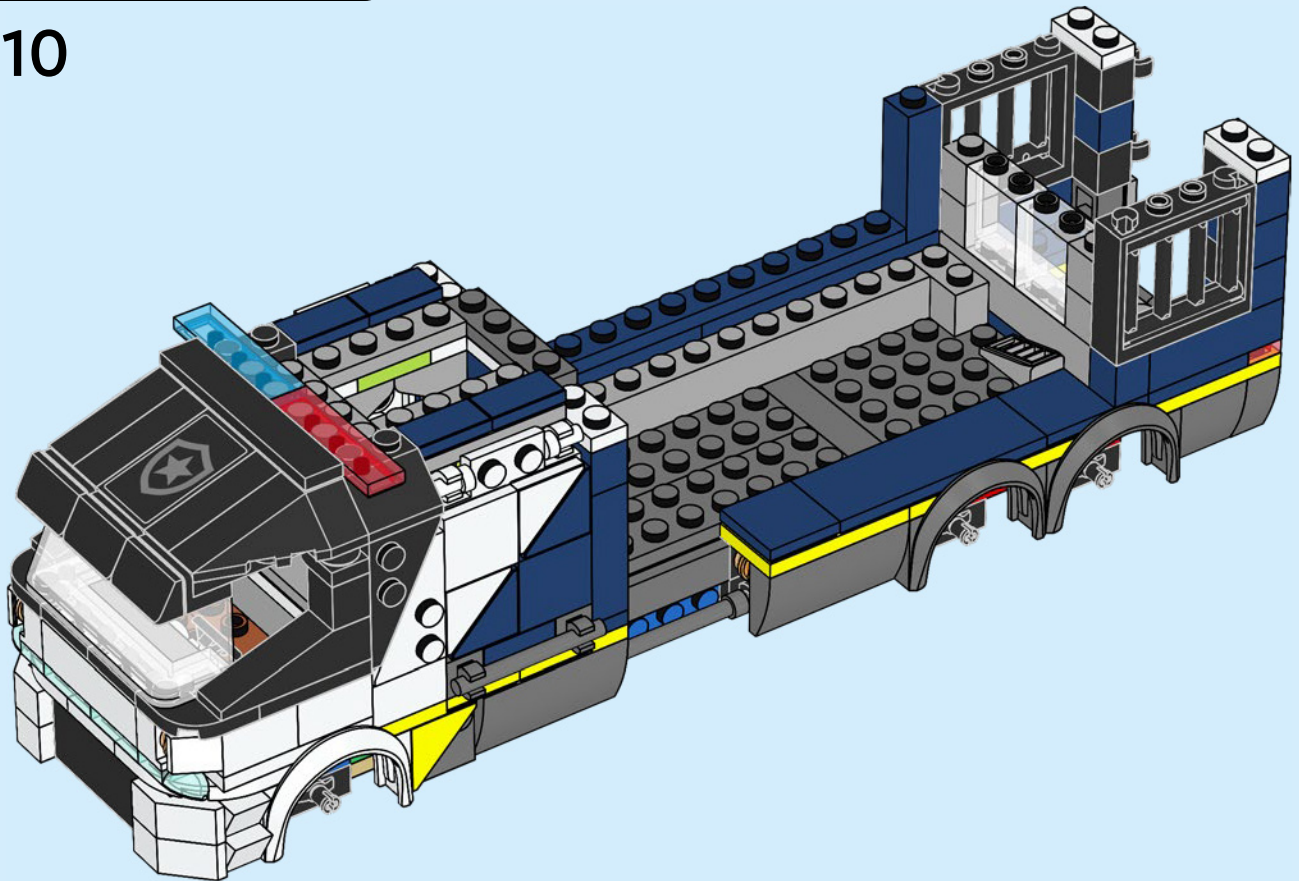

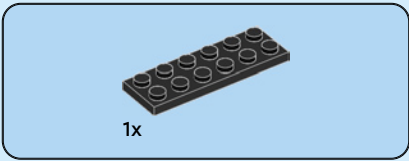

111

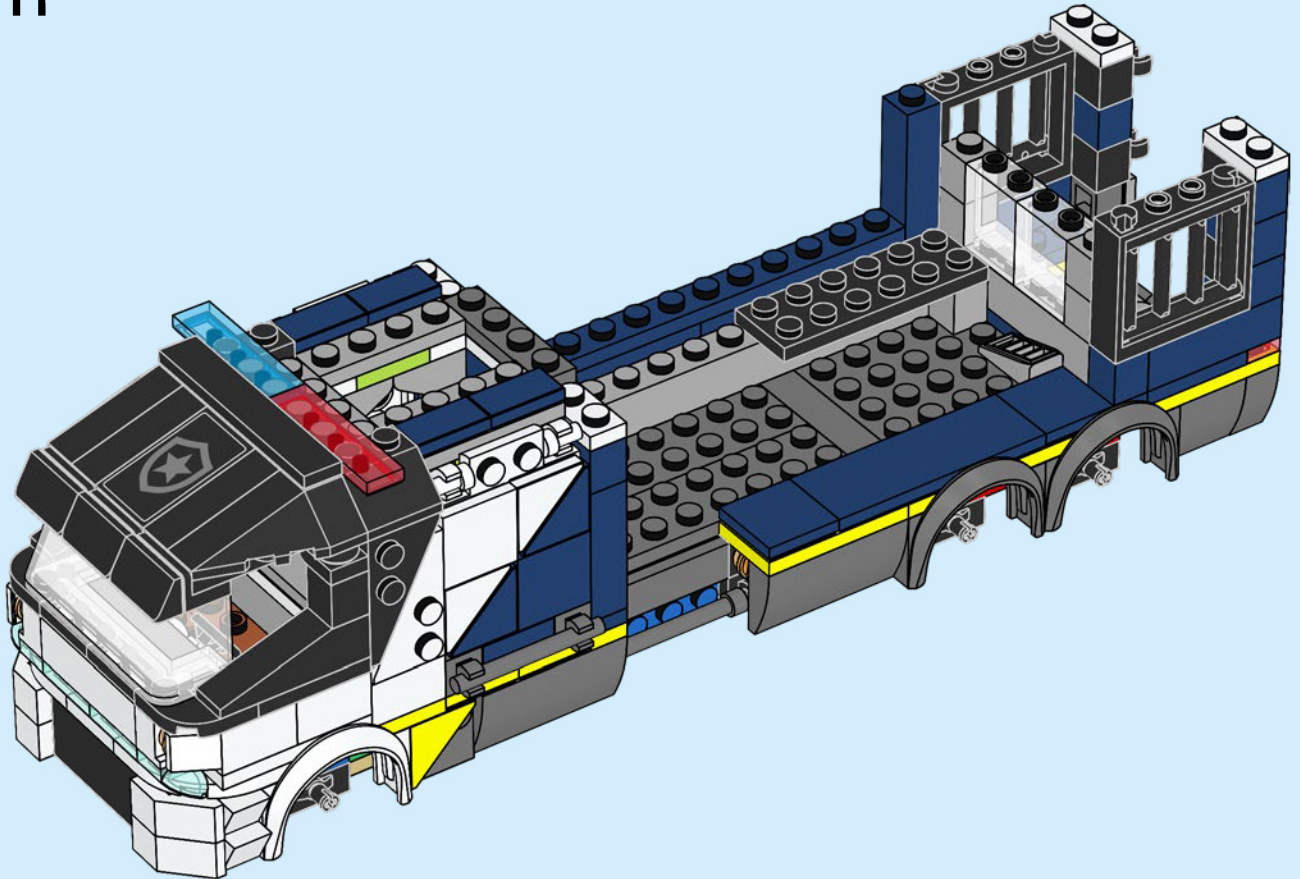



1x

112

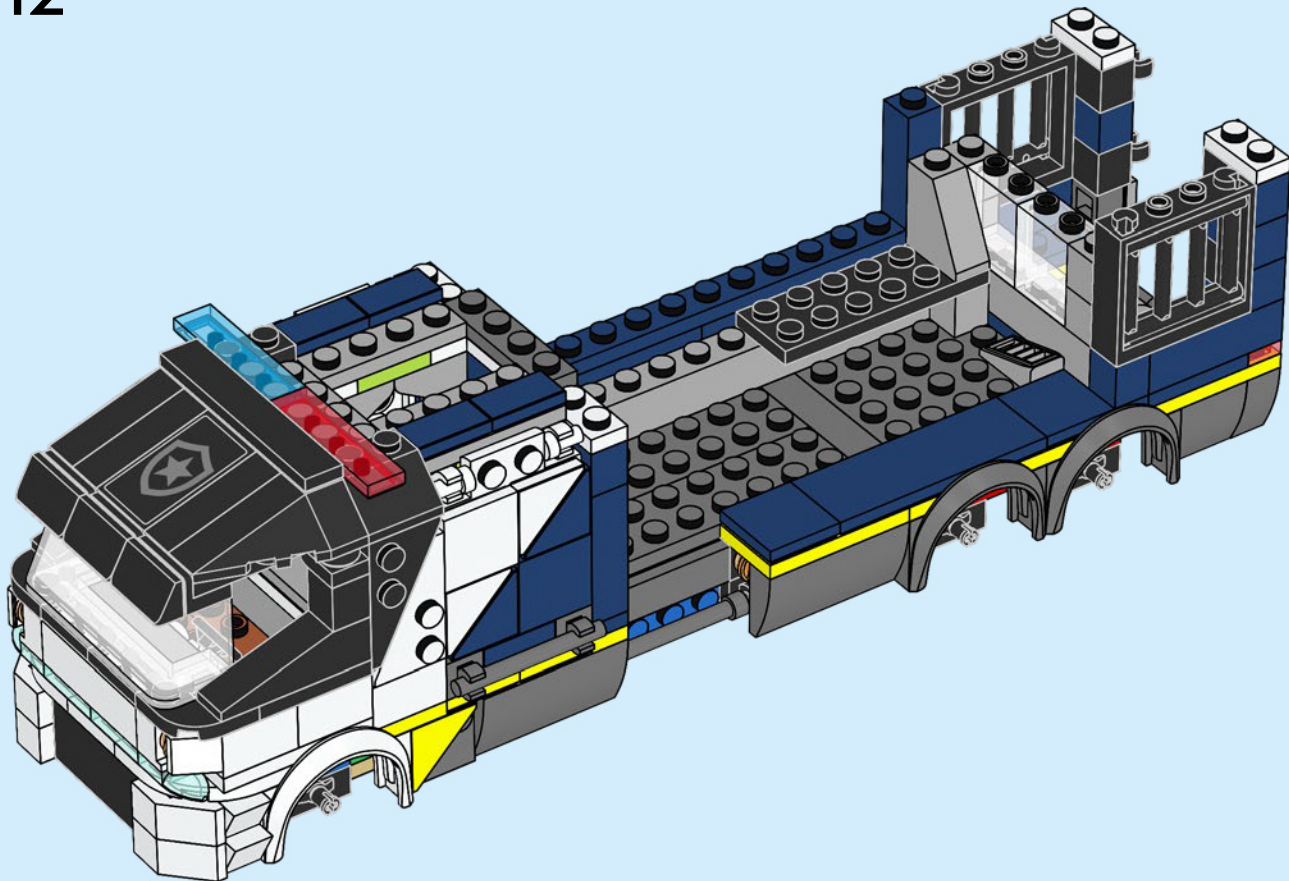



1x

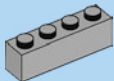

1x

113

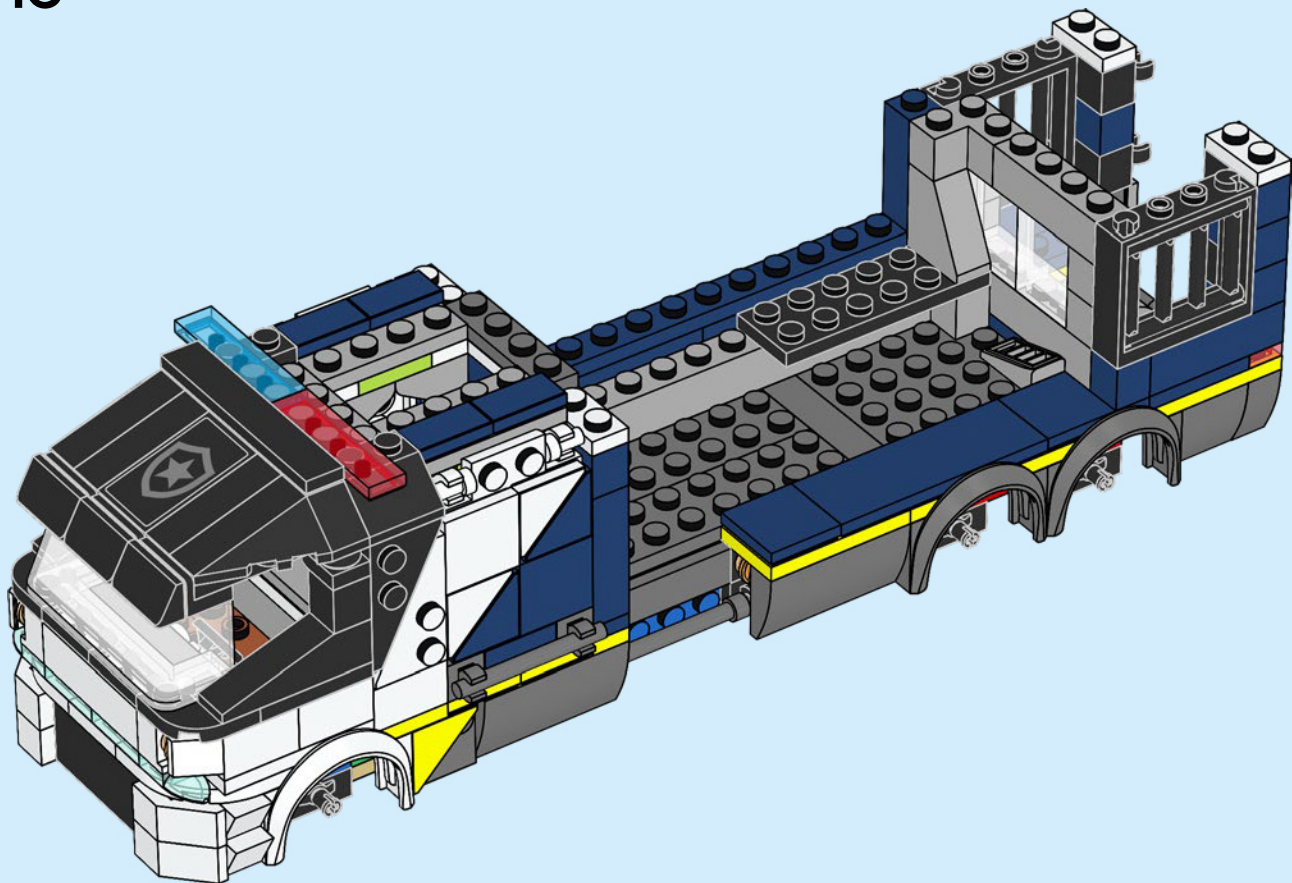

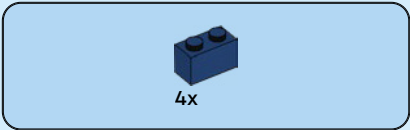

114

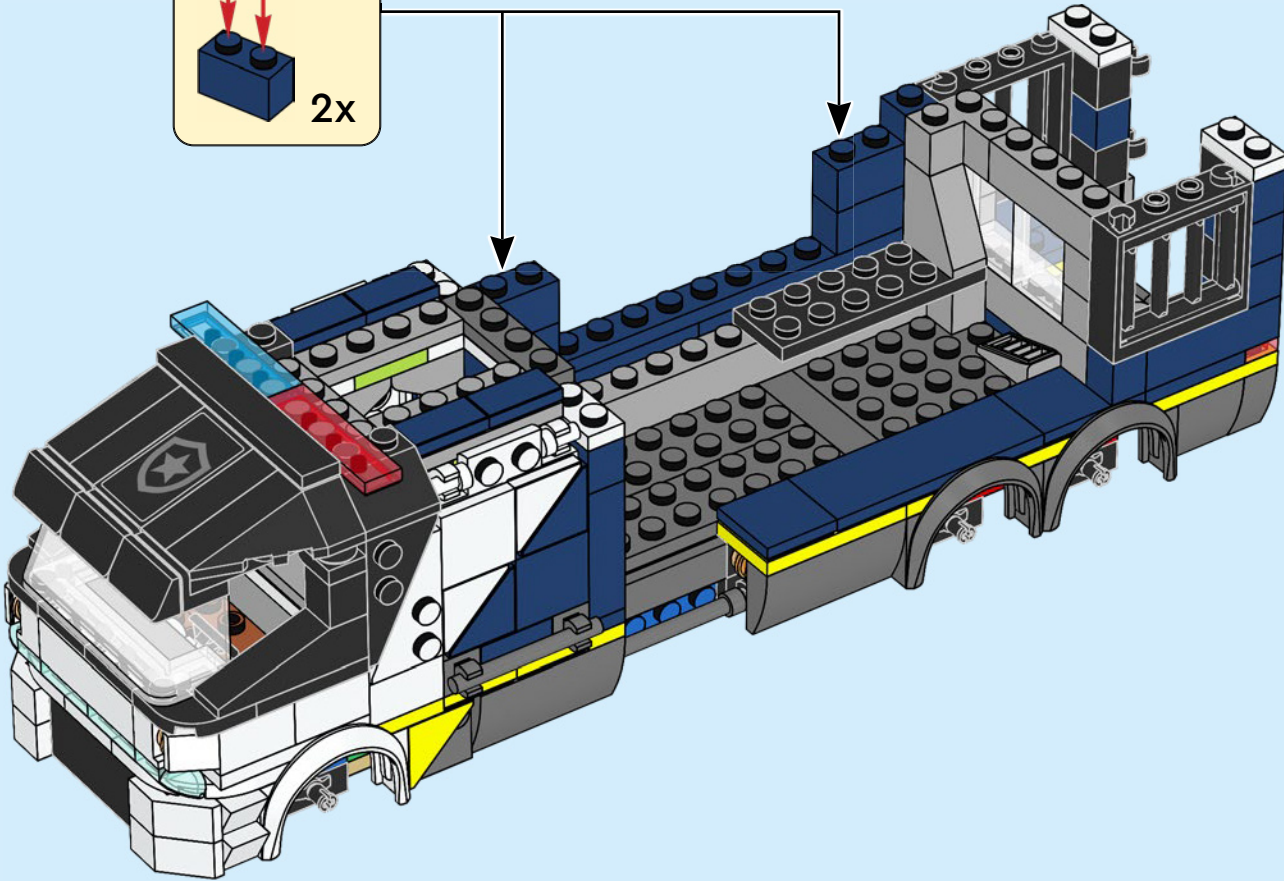
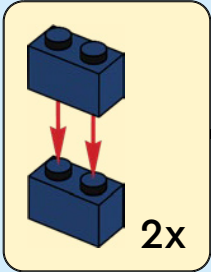

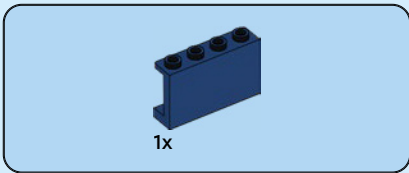

115

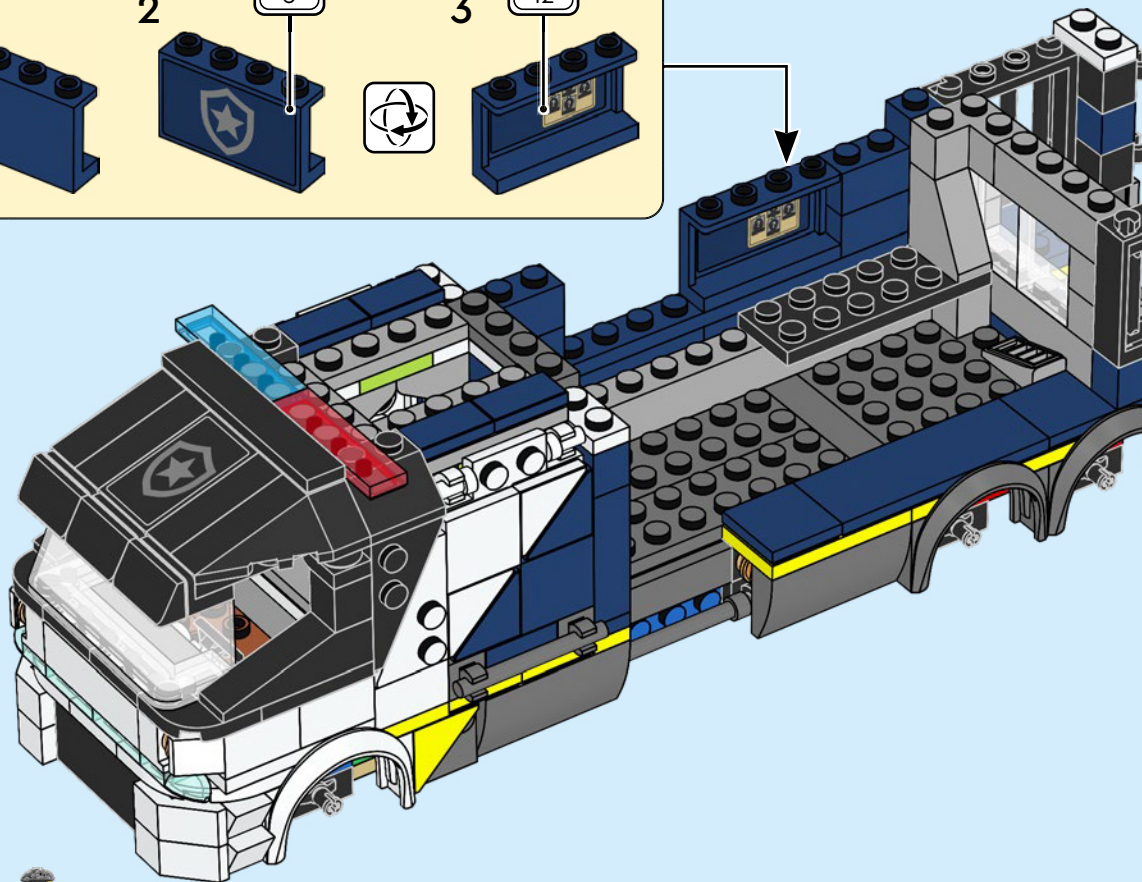
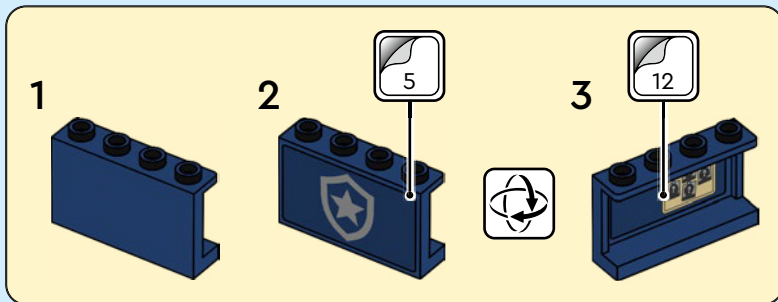

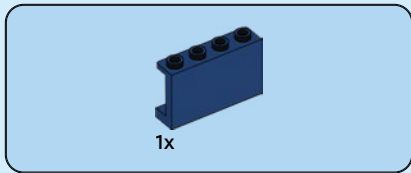

116

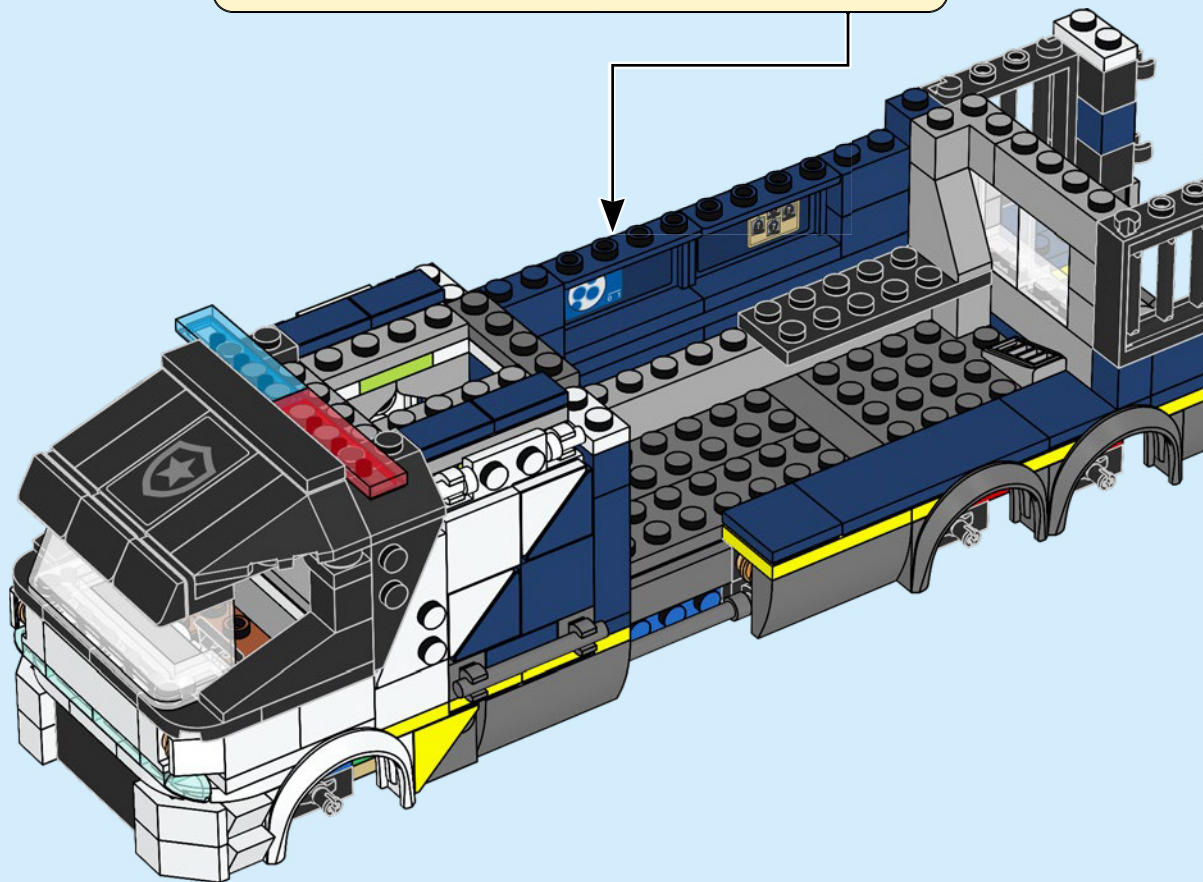
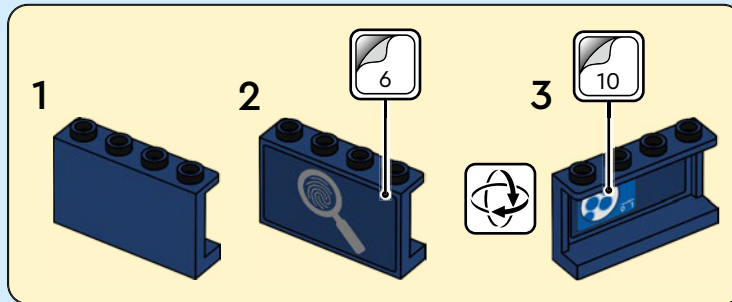

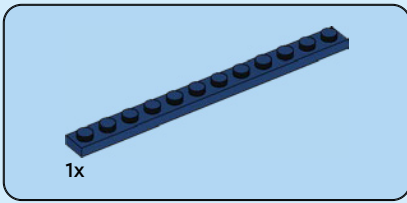

117

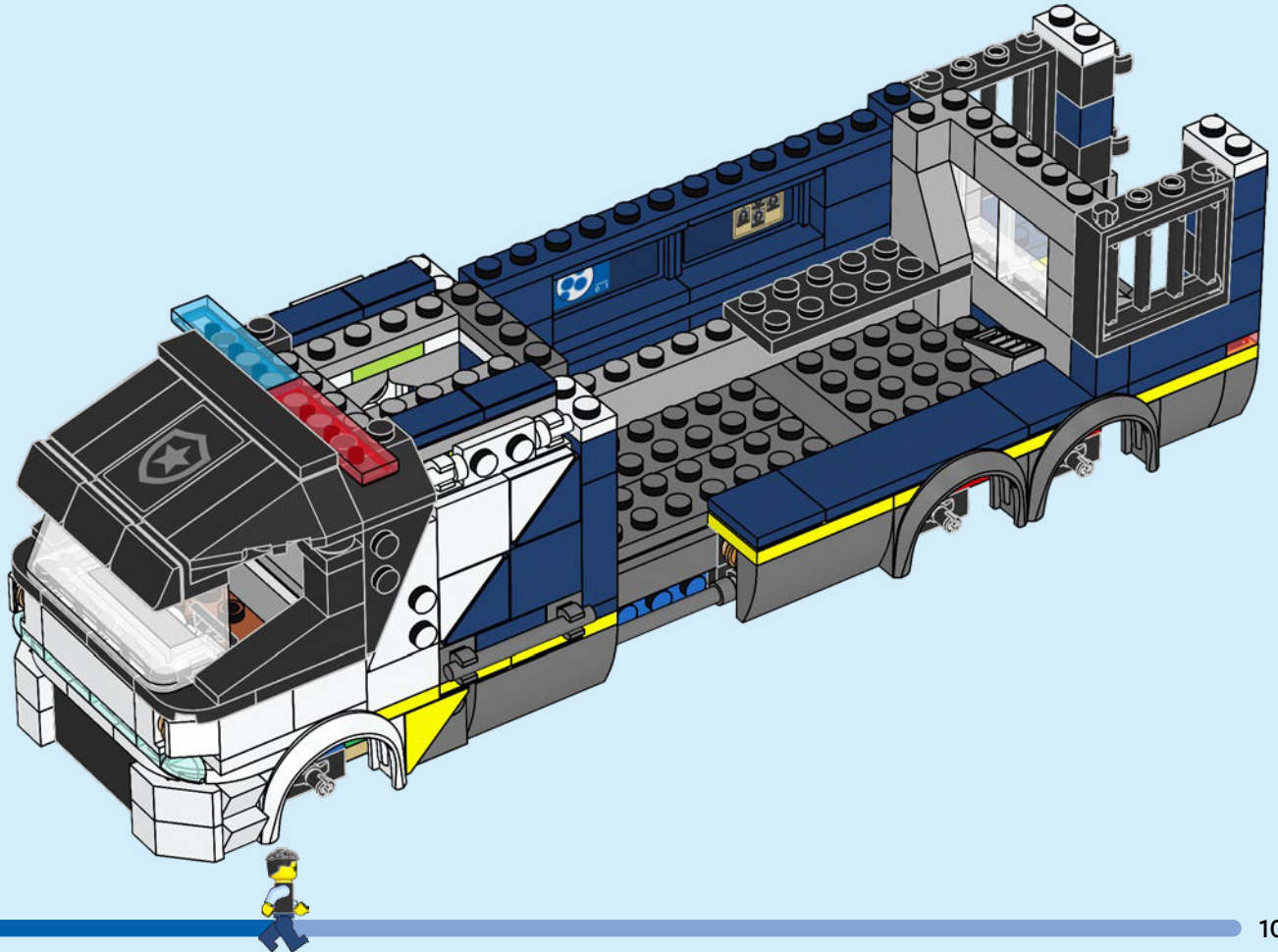



1x



1x

118

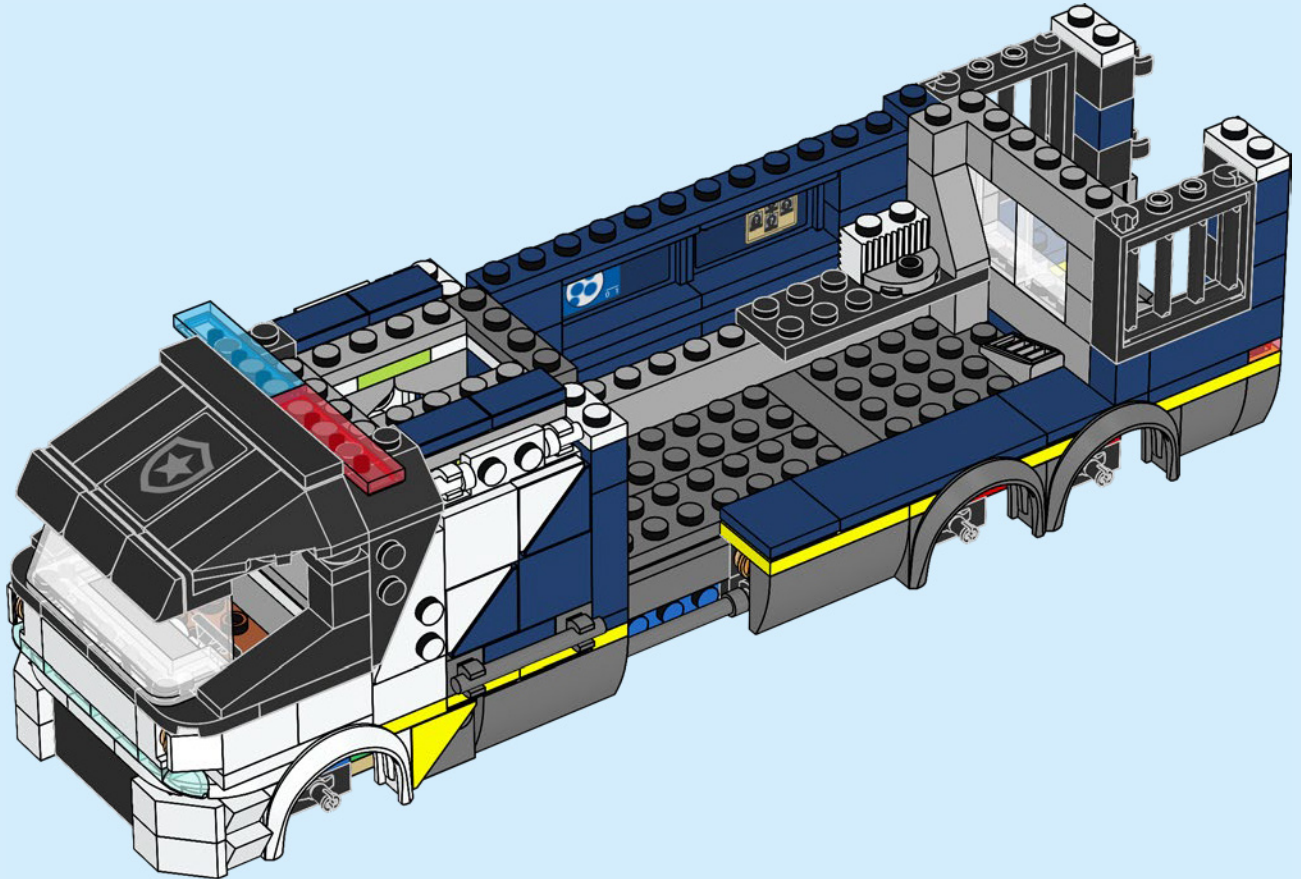



1x



1x

119

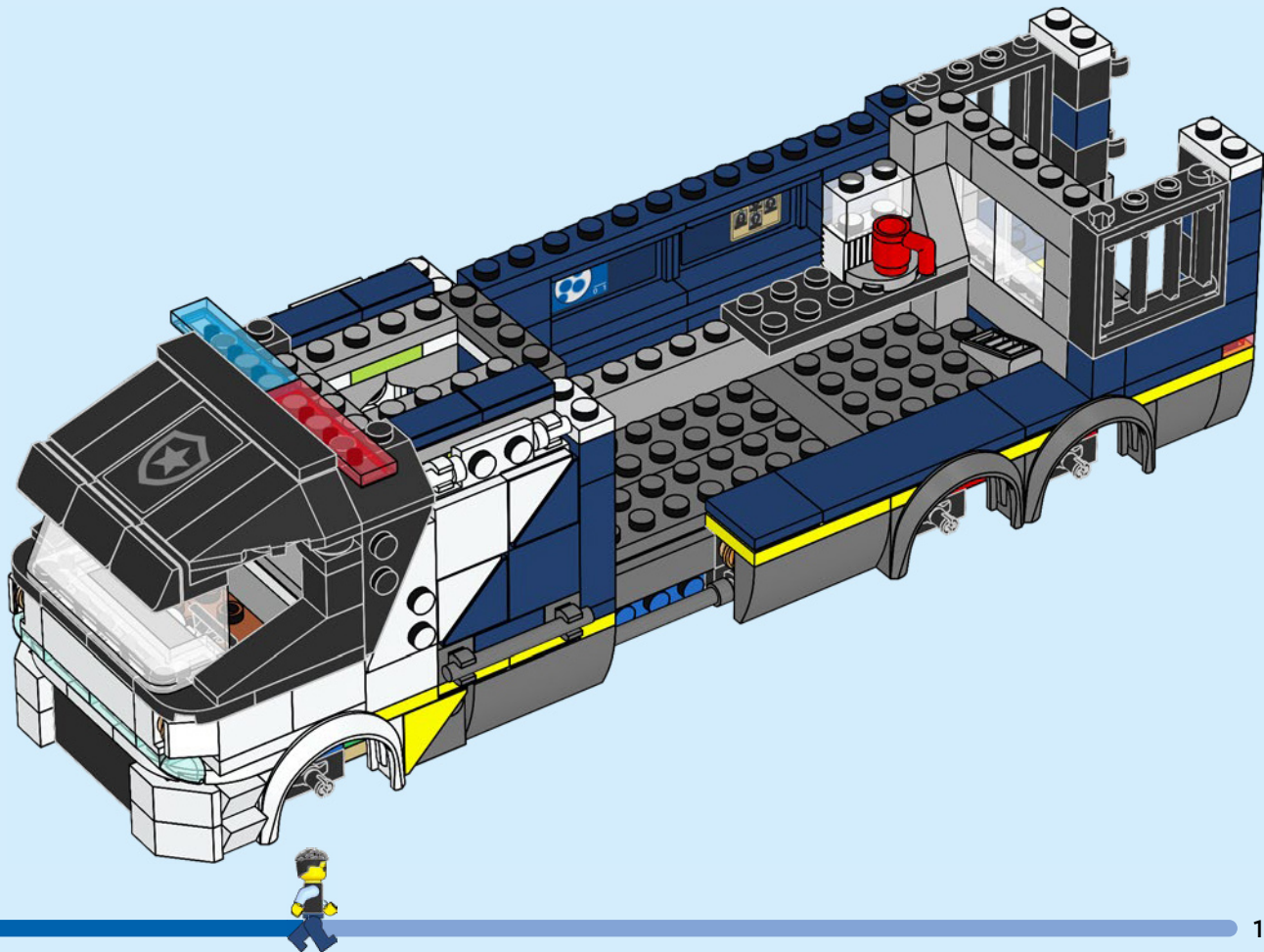

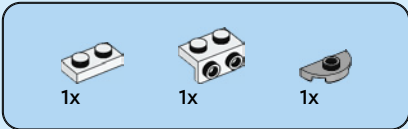

120

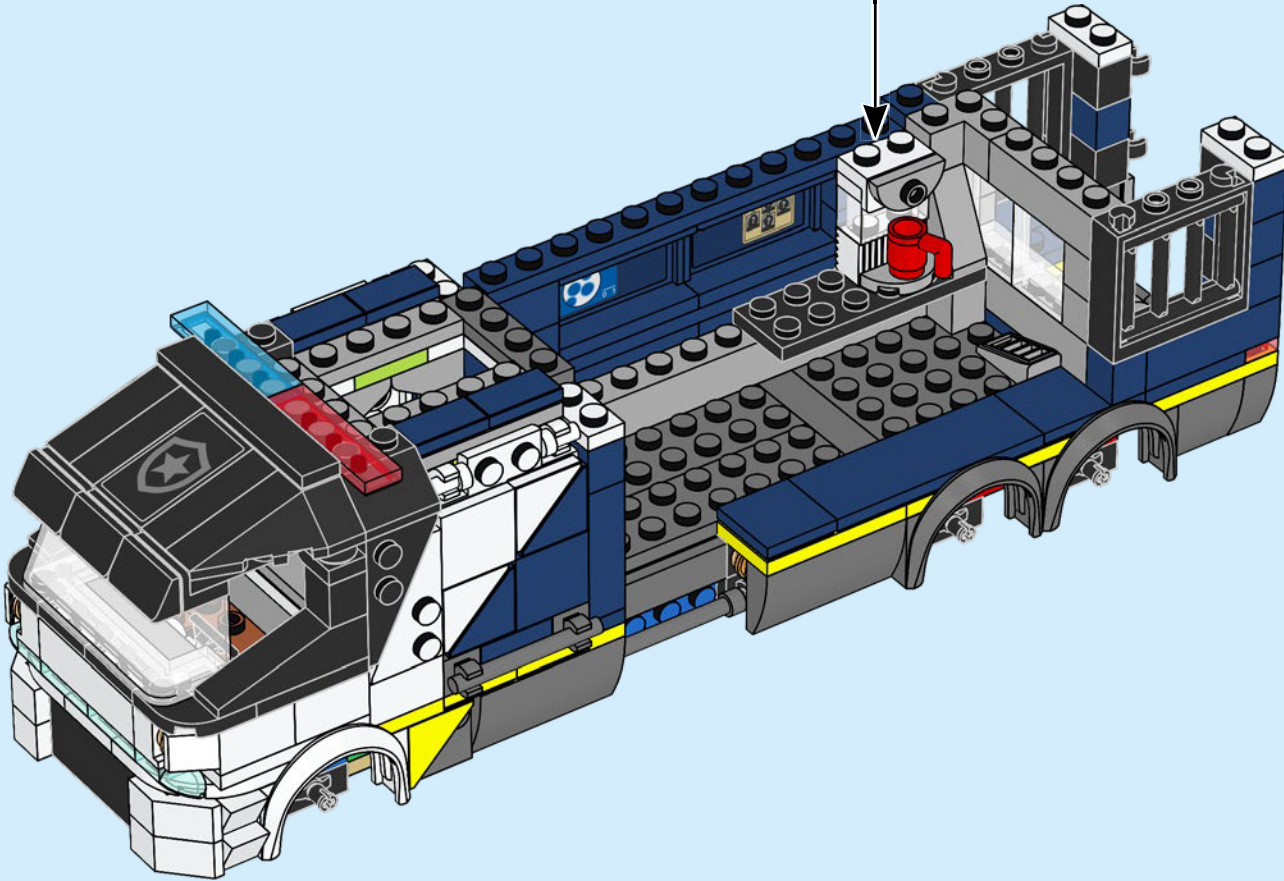
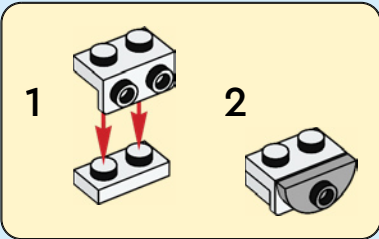



1x



1x

121

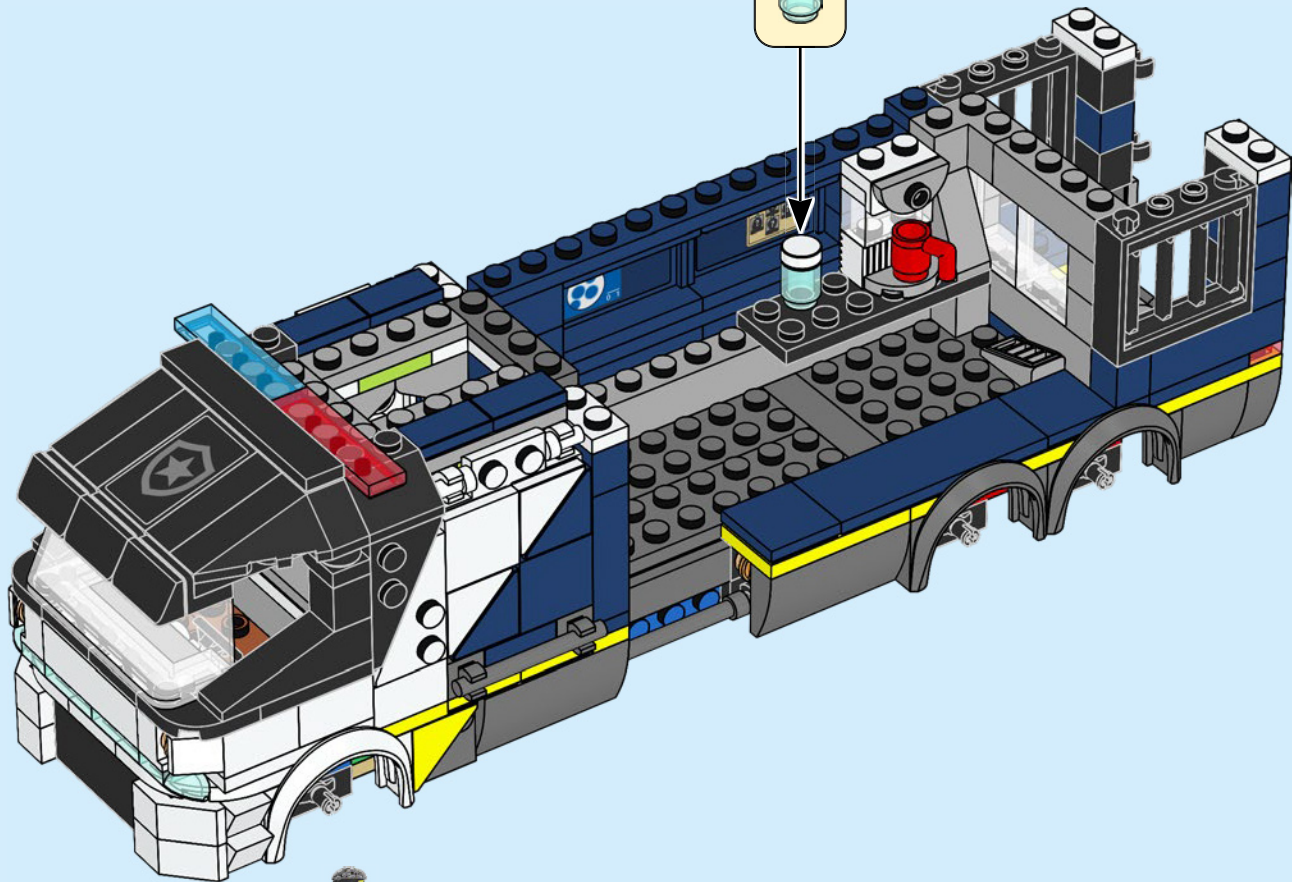
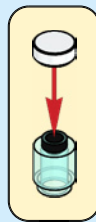



1x

122

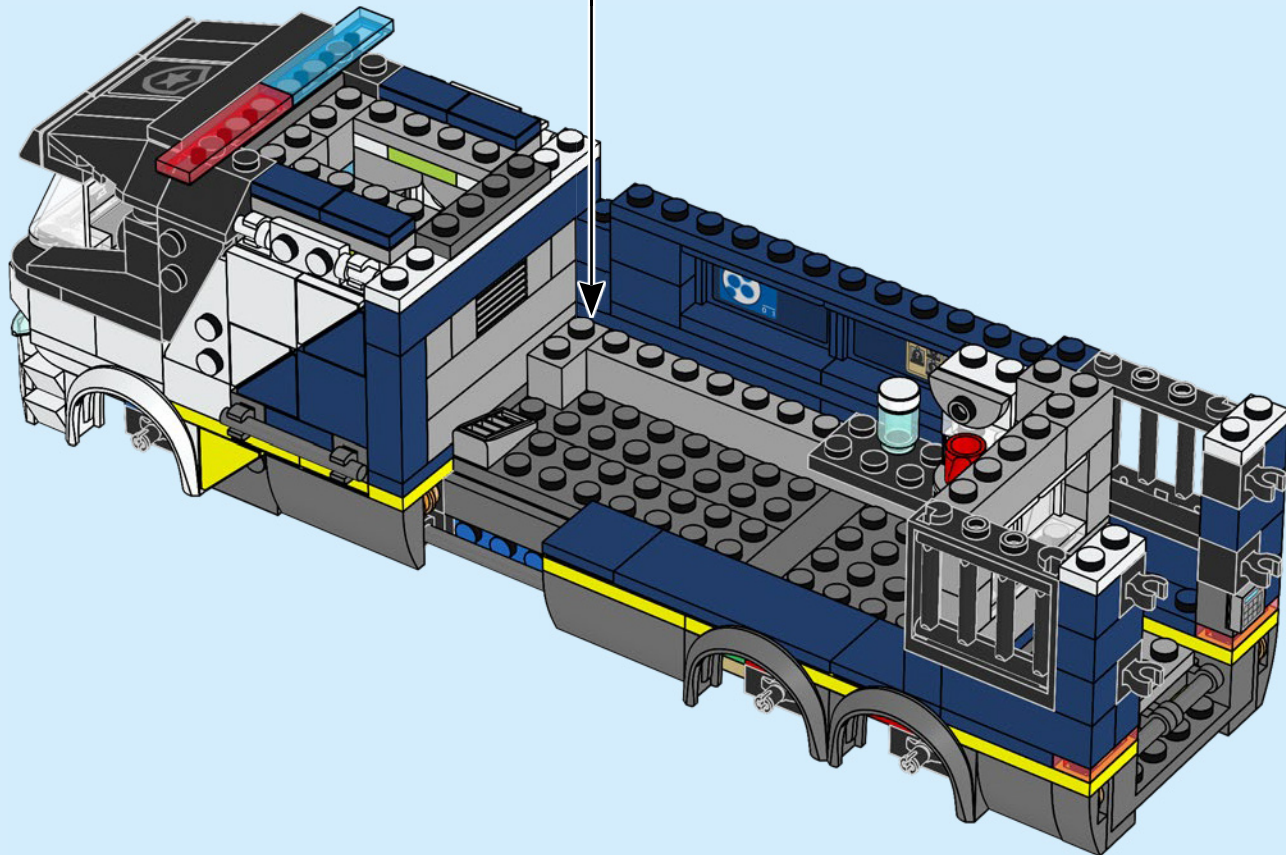
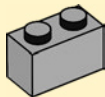

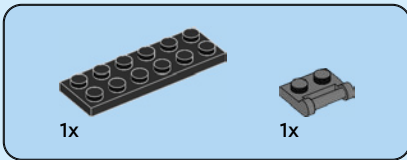

123

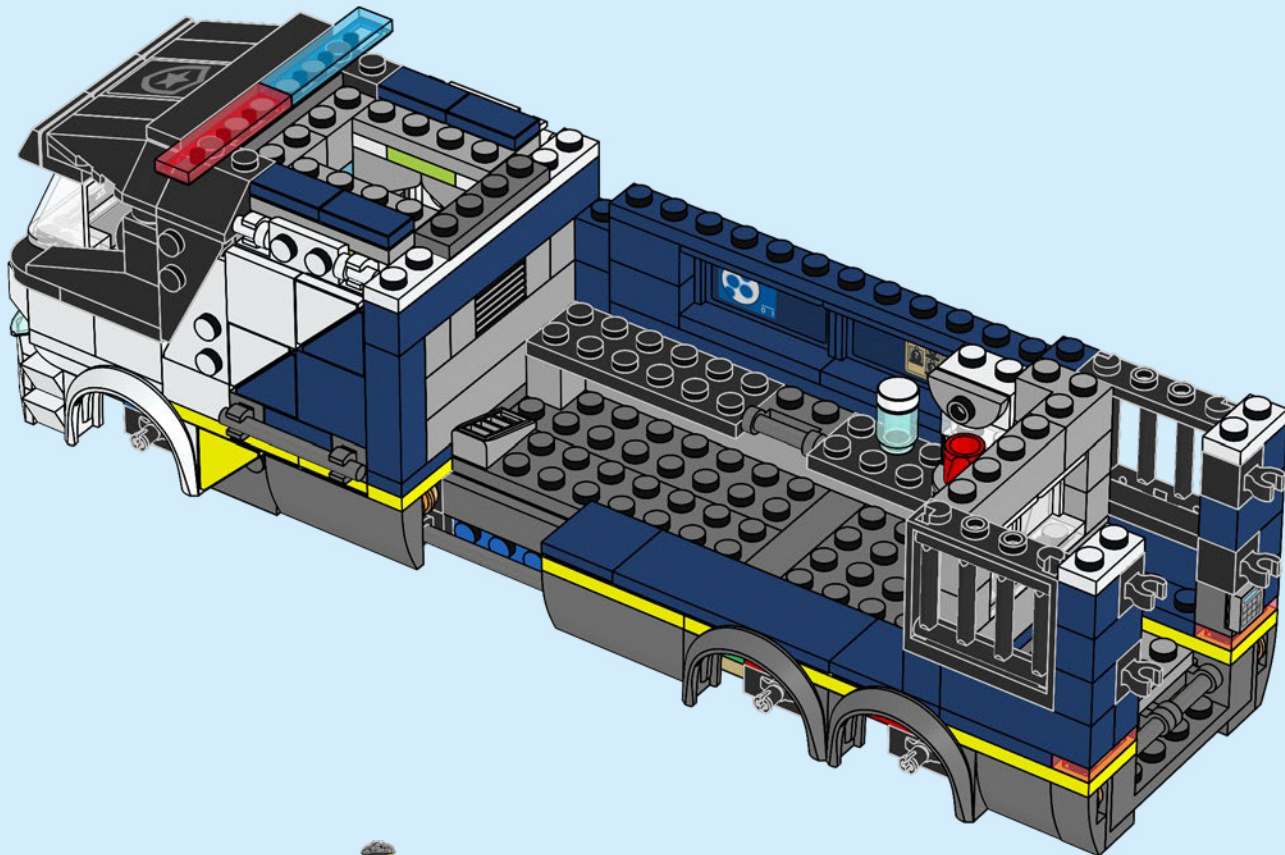



1x

124

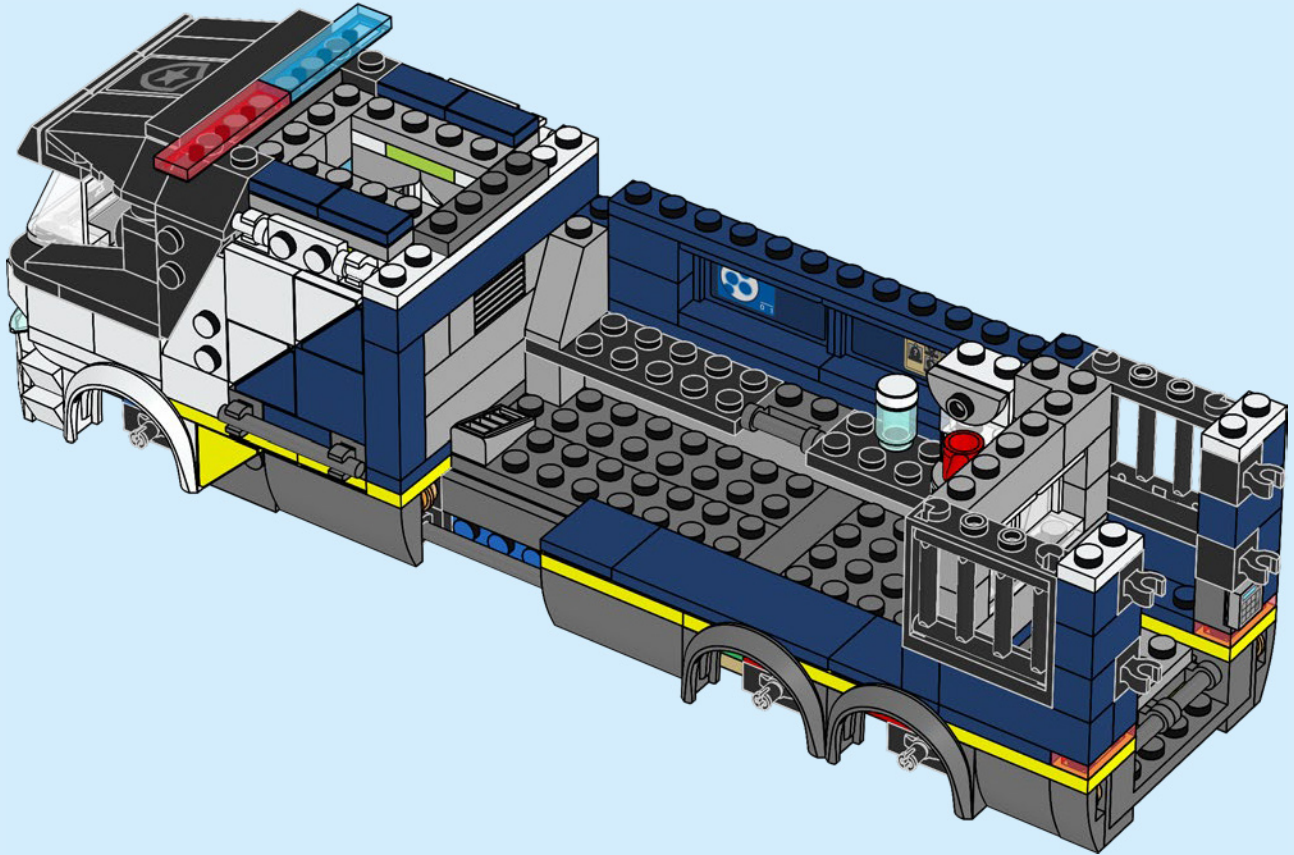

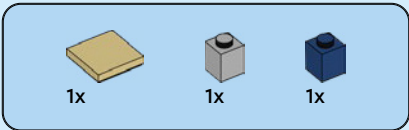

125

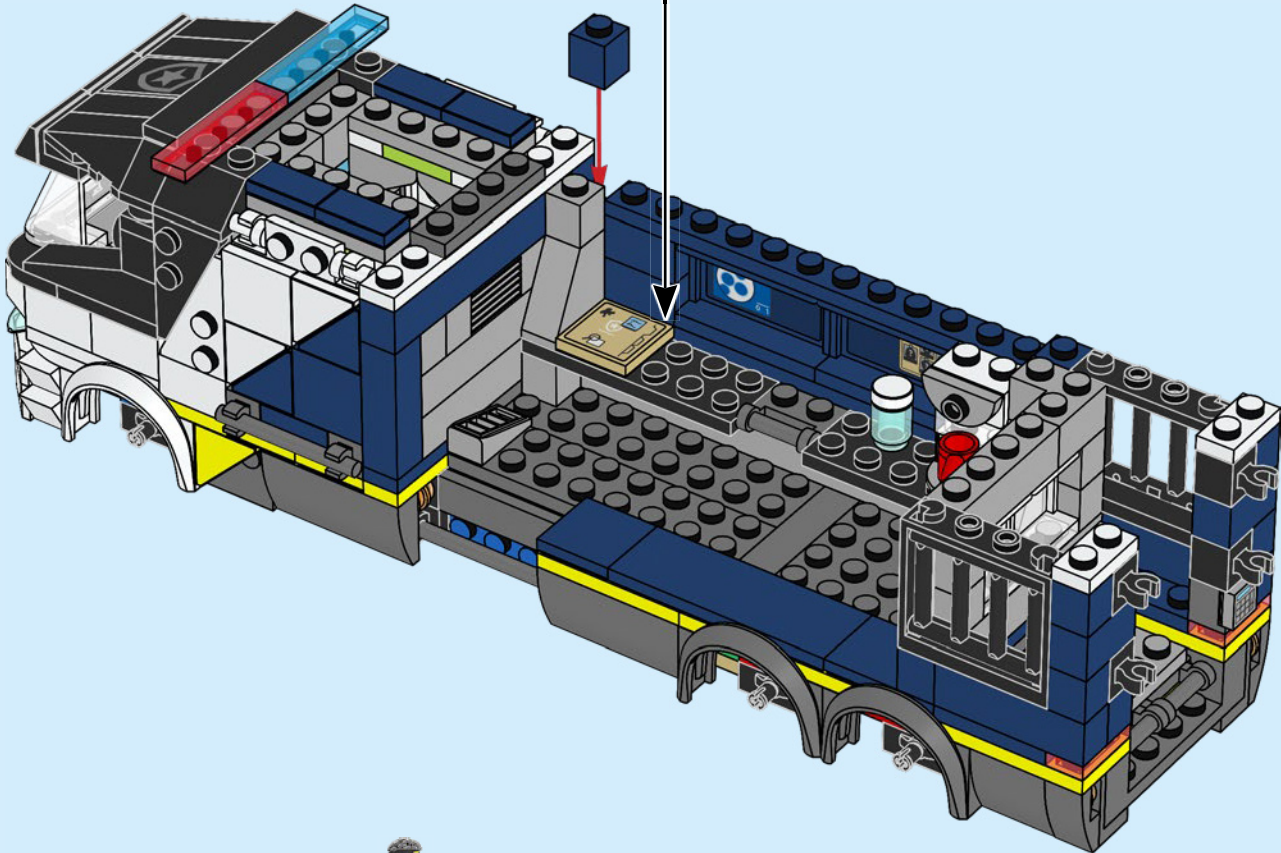
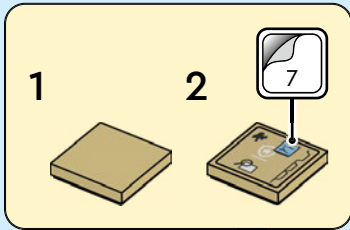

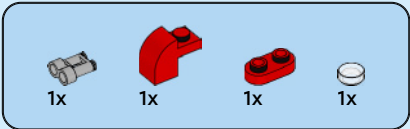

126

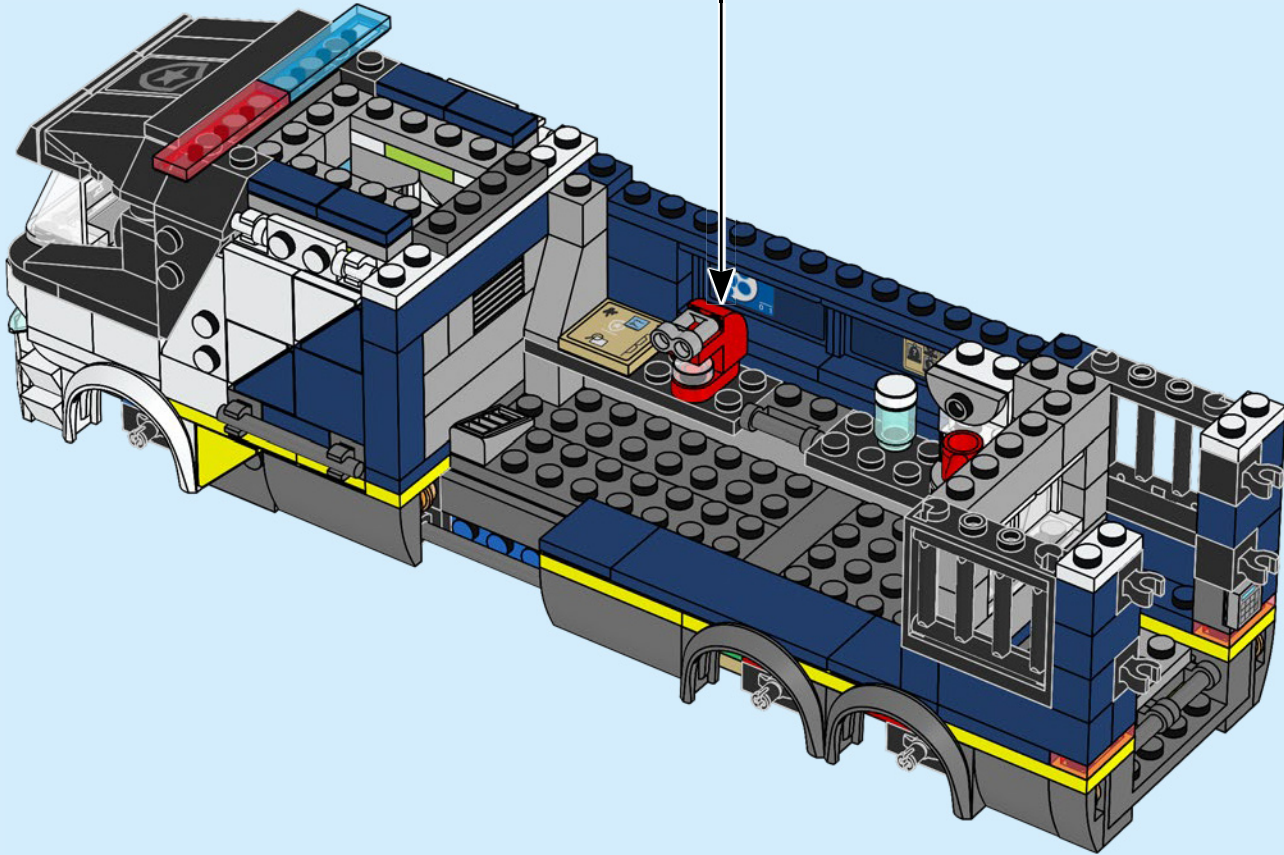
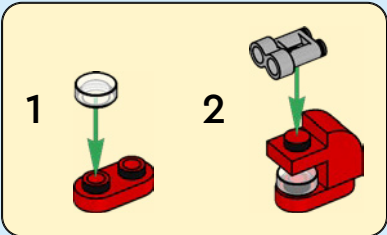

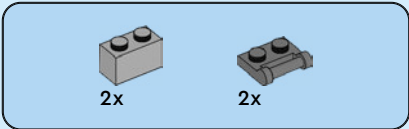

127

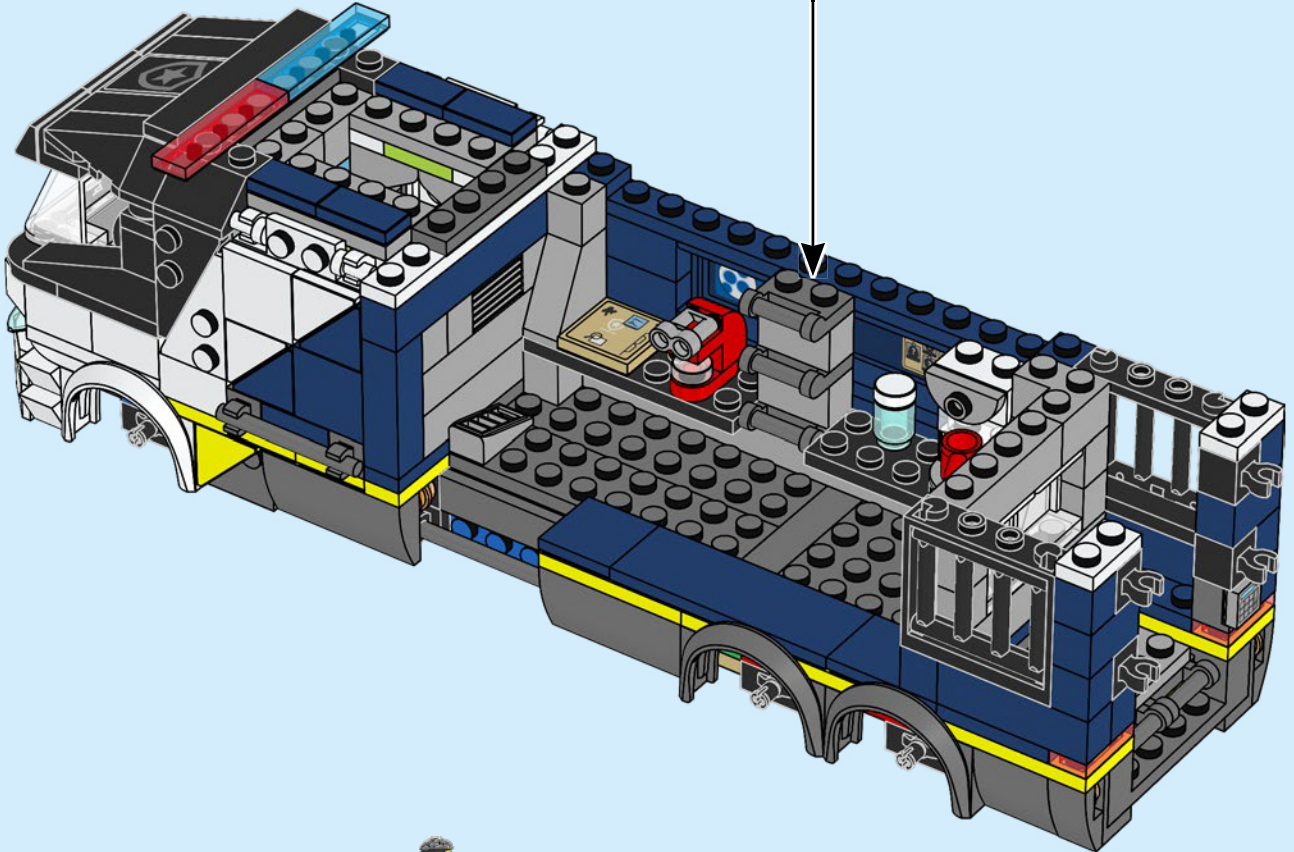
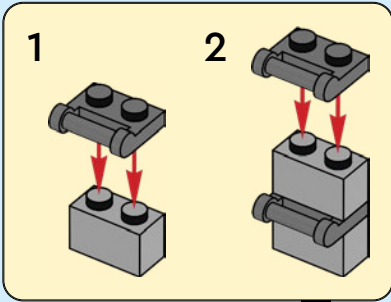

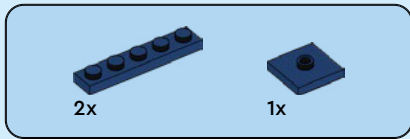

128

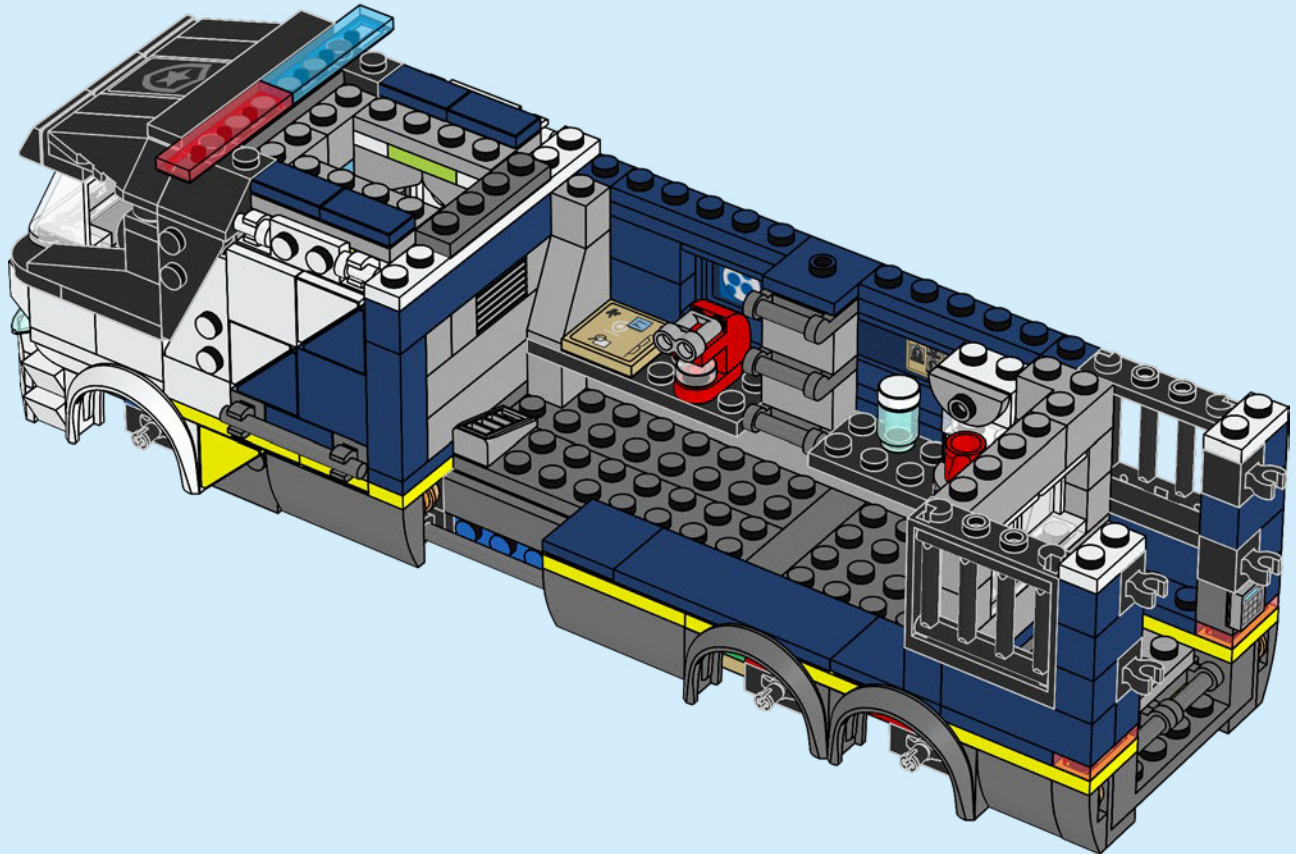

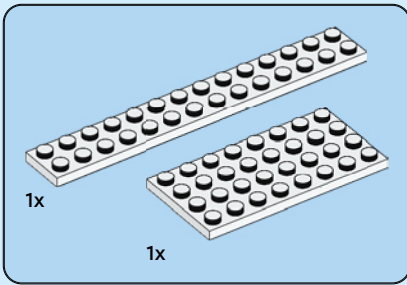

129

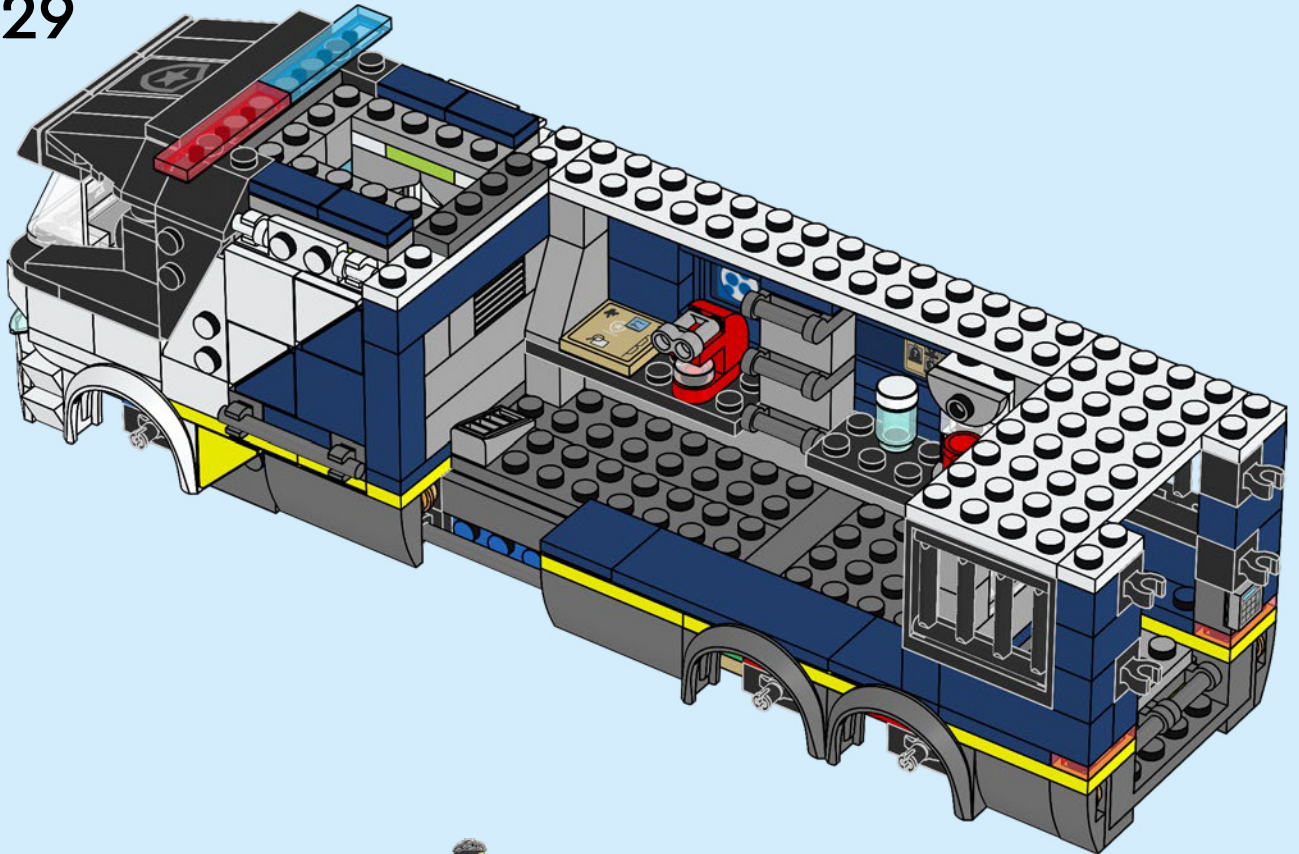

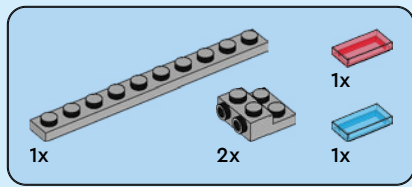

130

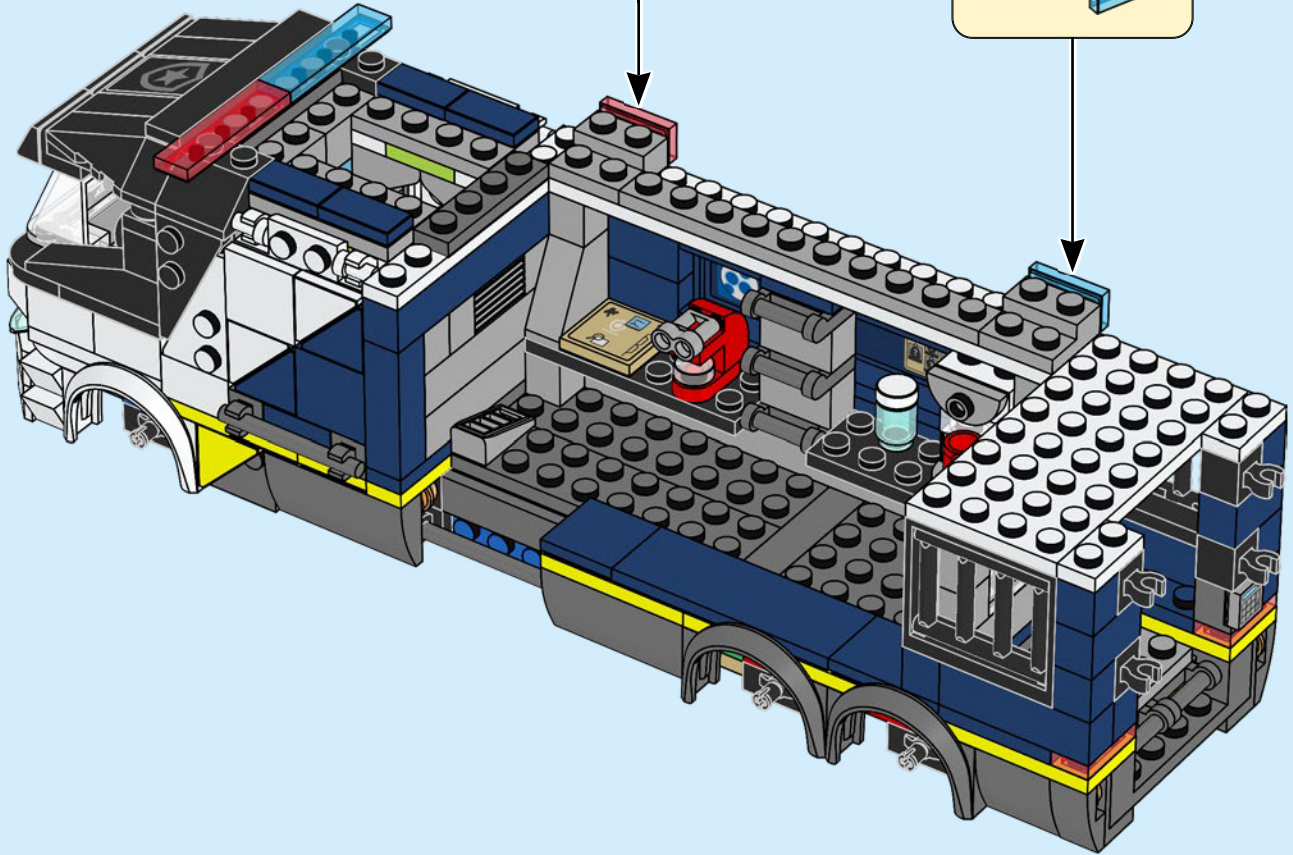
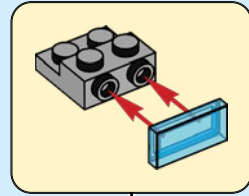
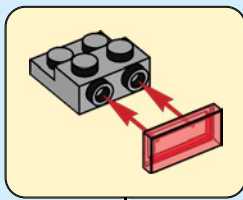



5x

131

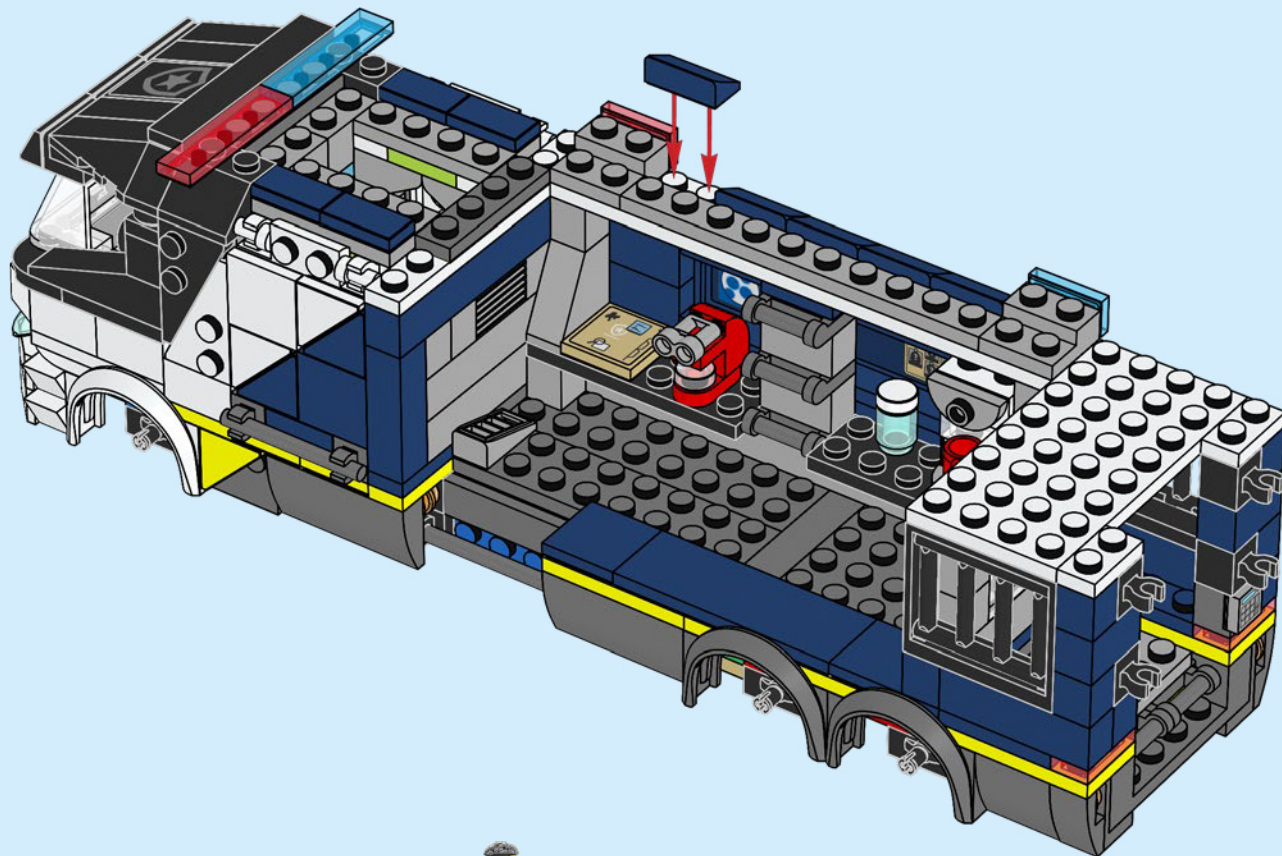

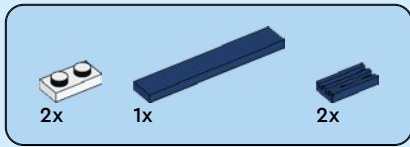

132

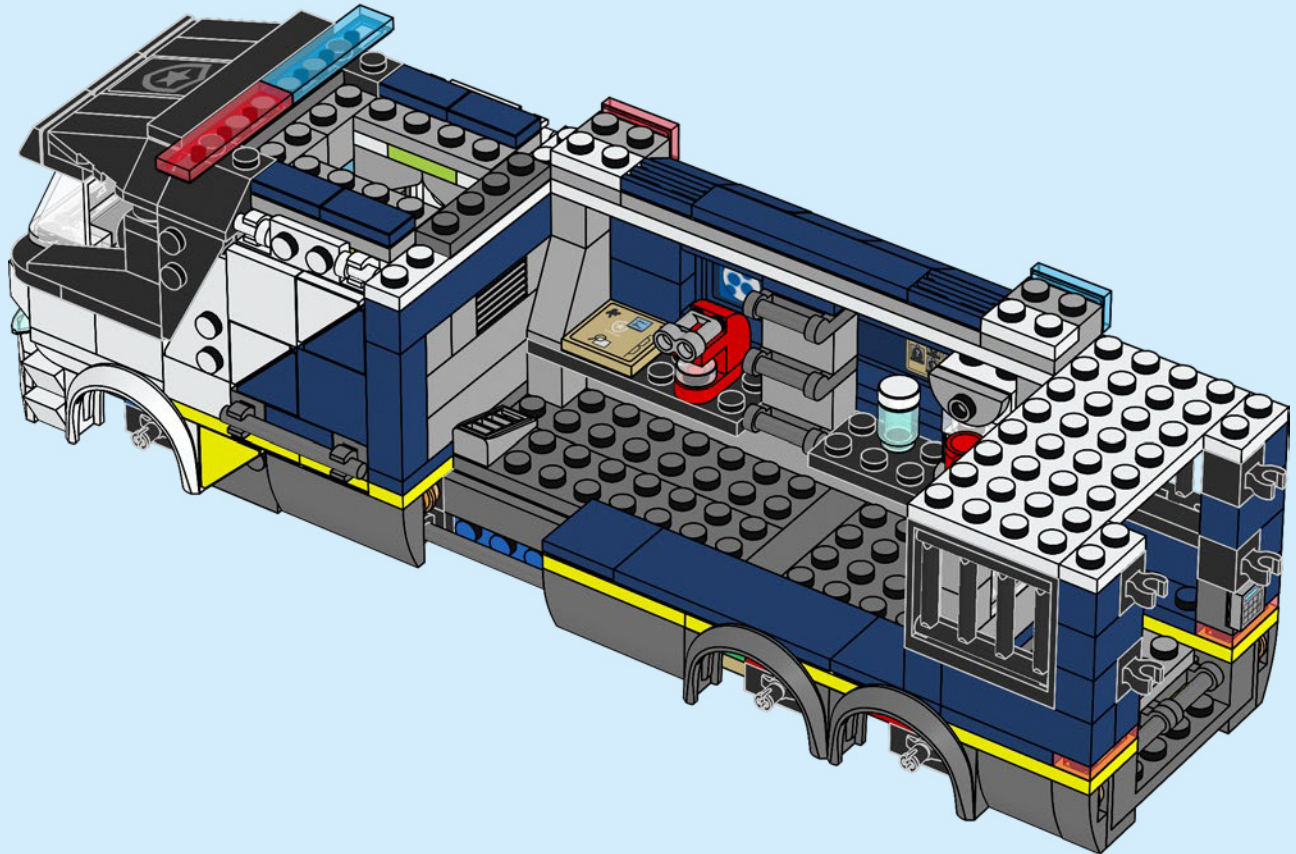



2x

133

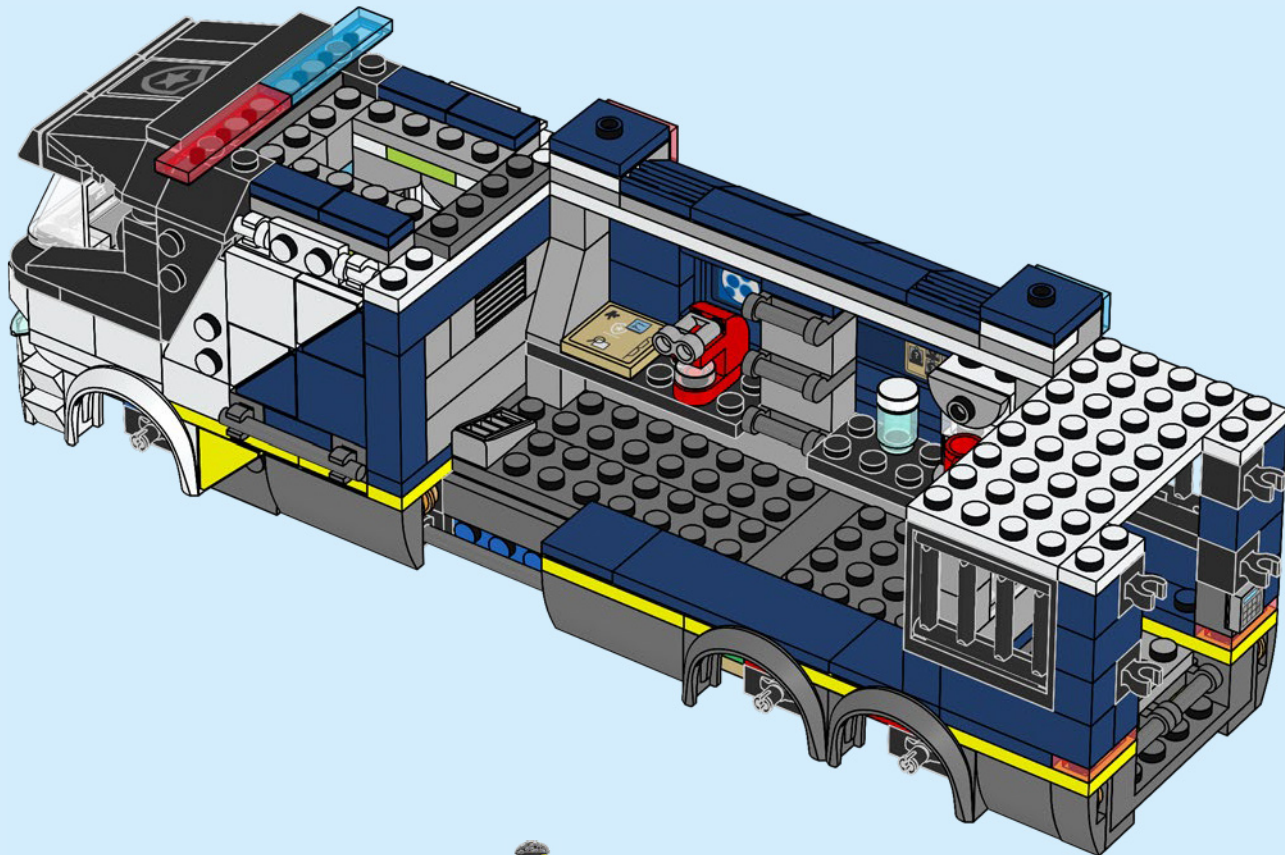



2x



4x

134

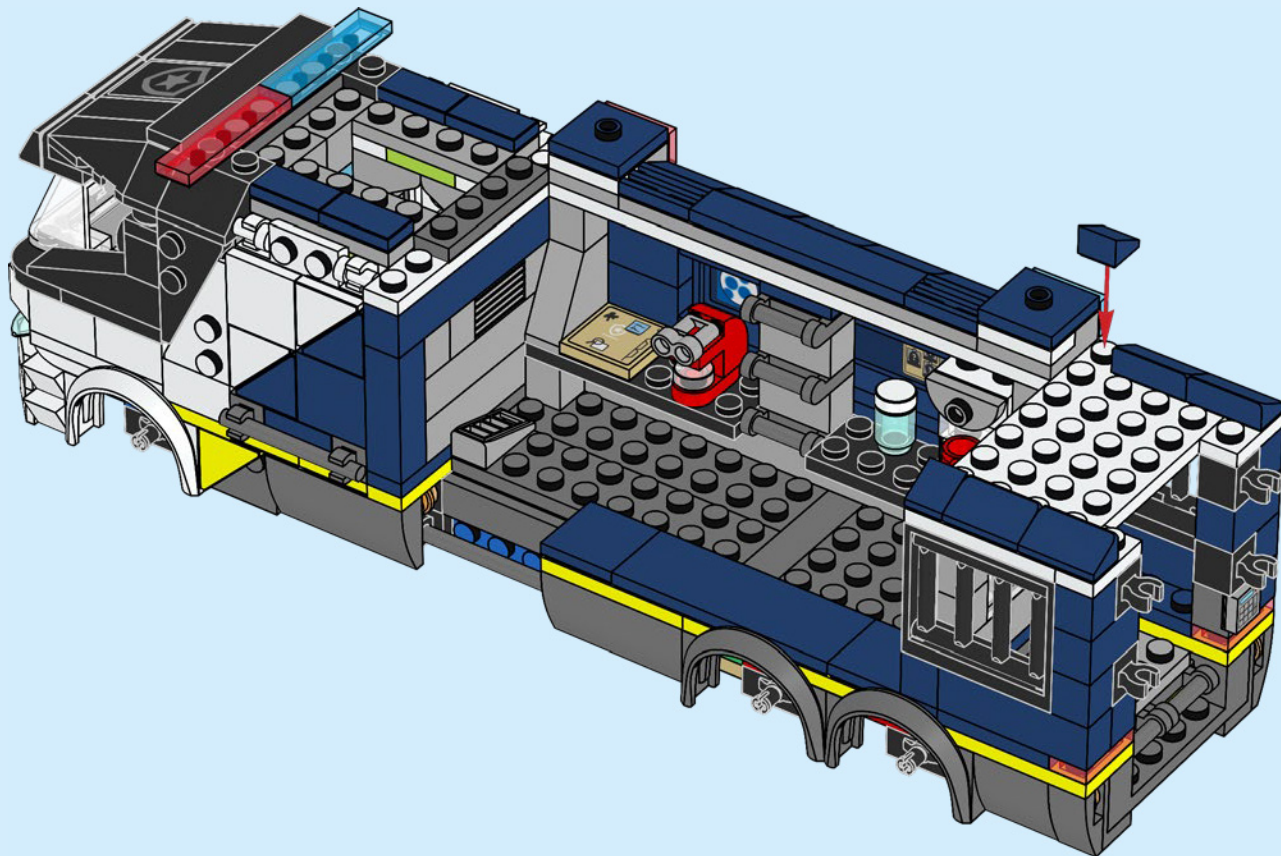

2x

135

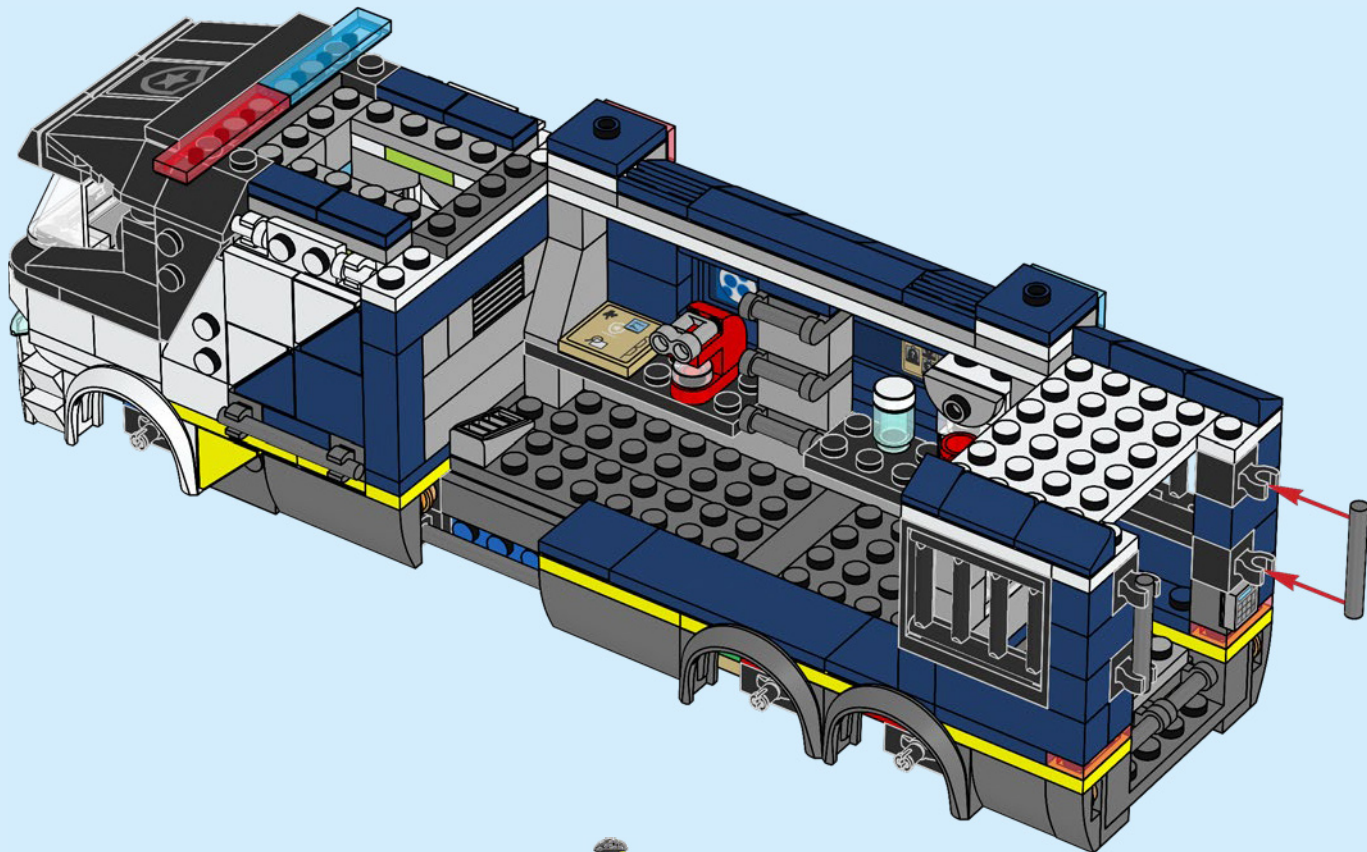

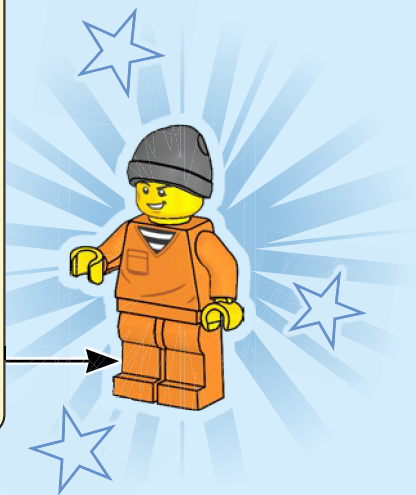
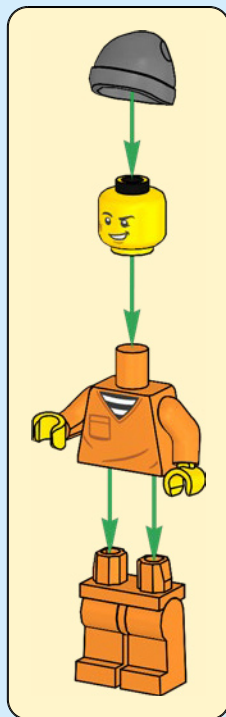



2x



2x

136

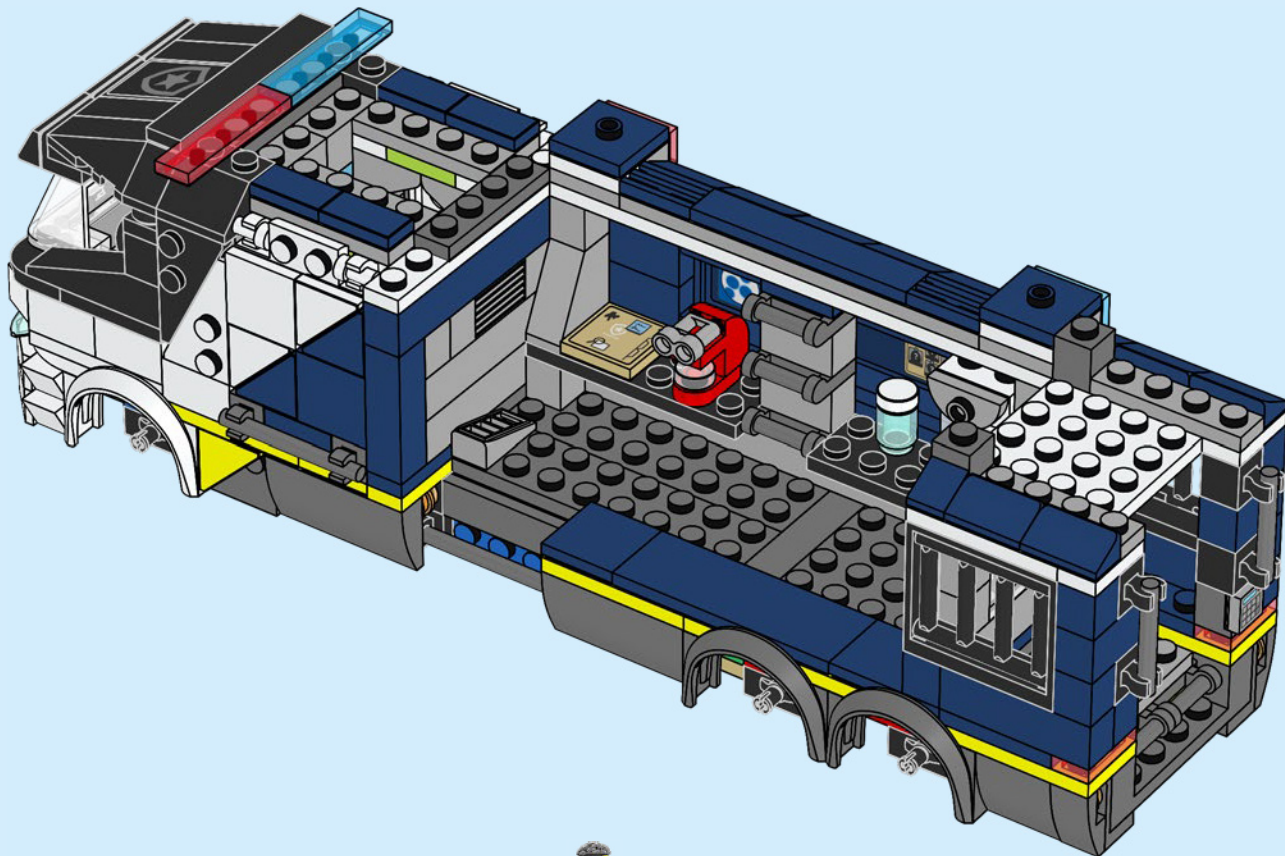

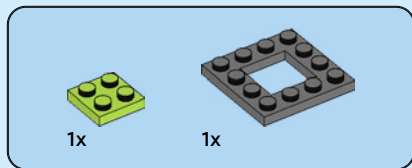

137

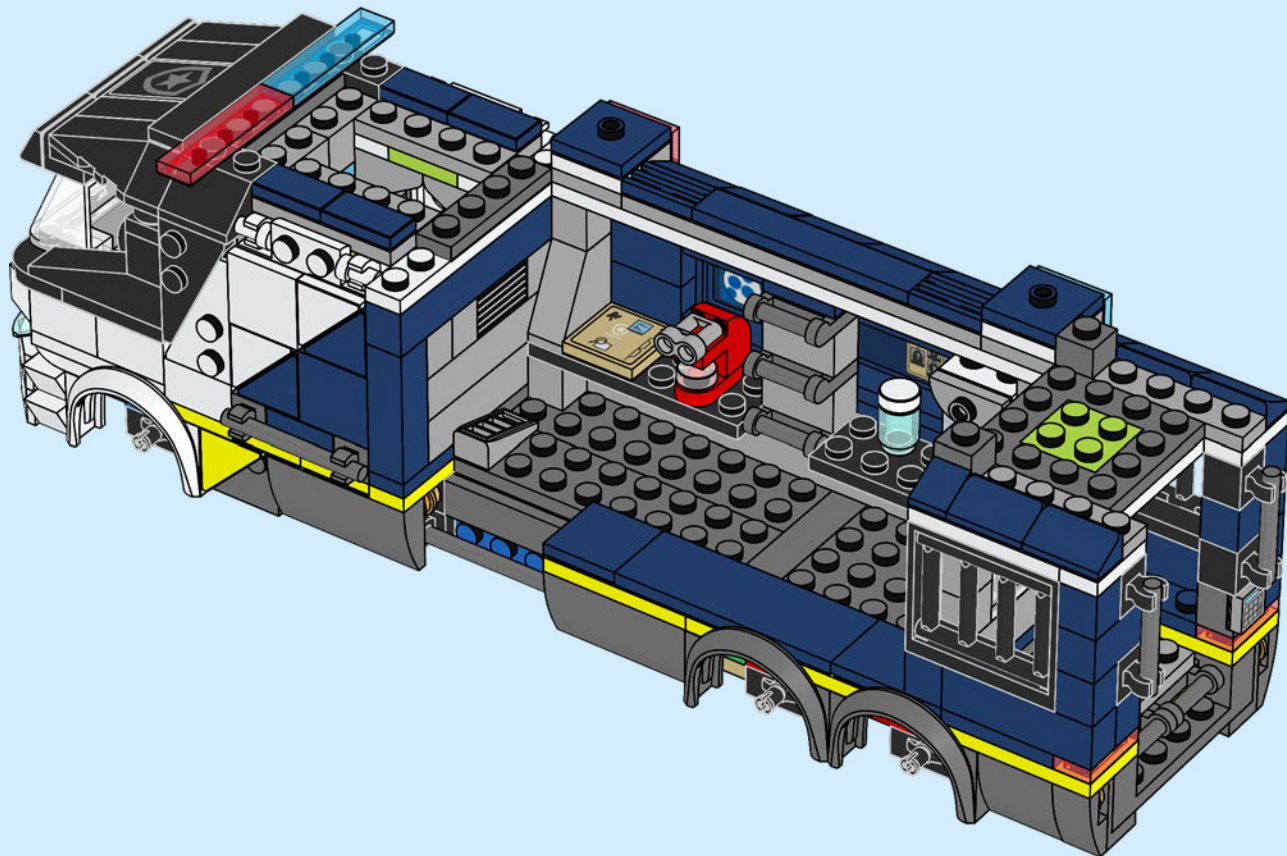



1x

138

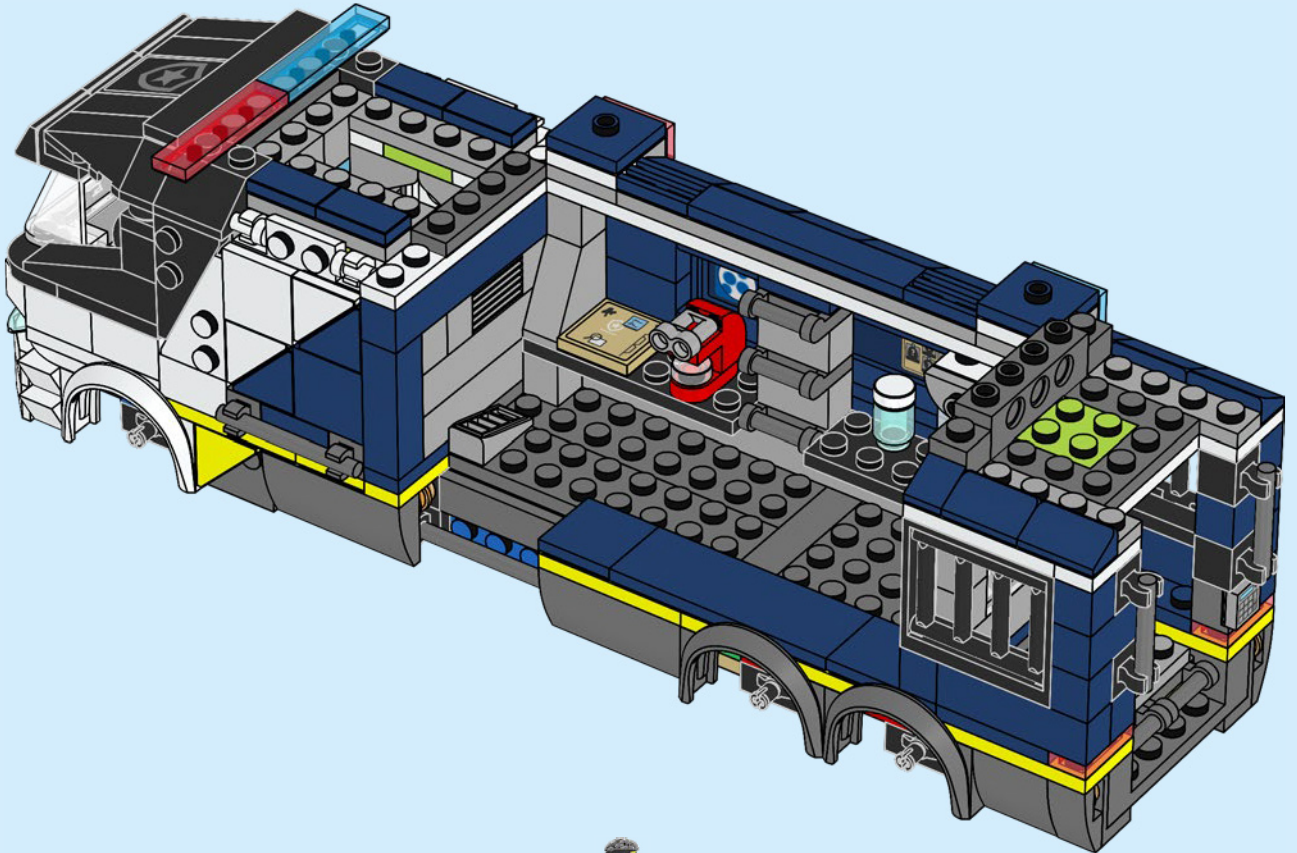

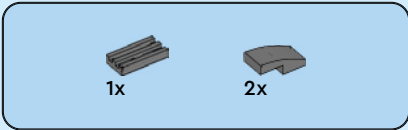

139

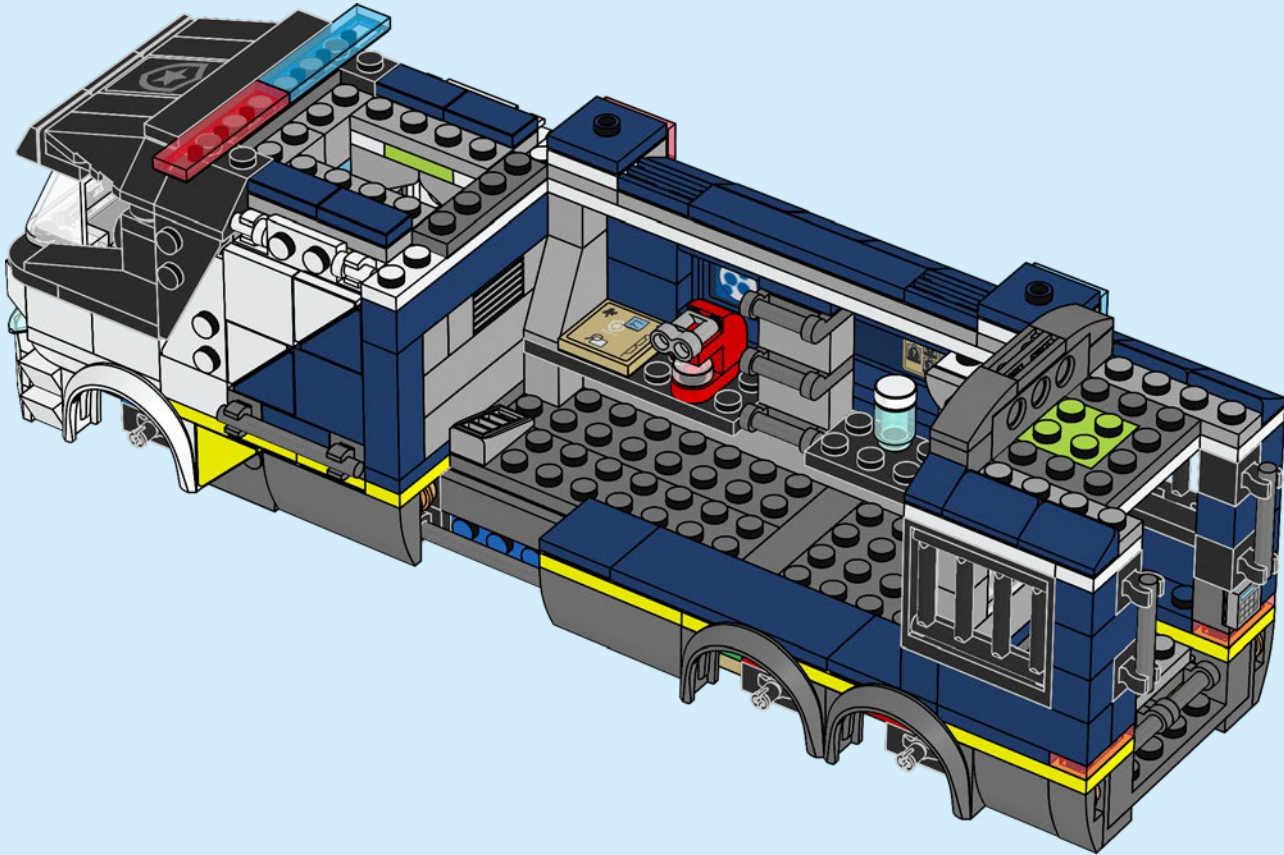



2x

140

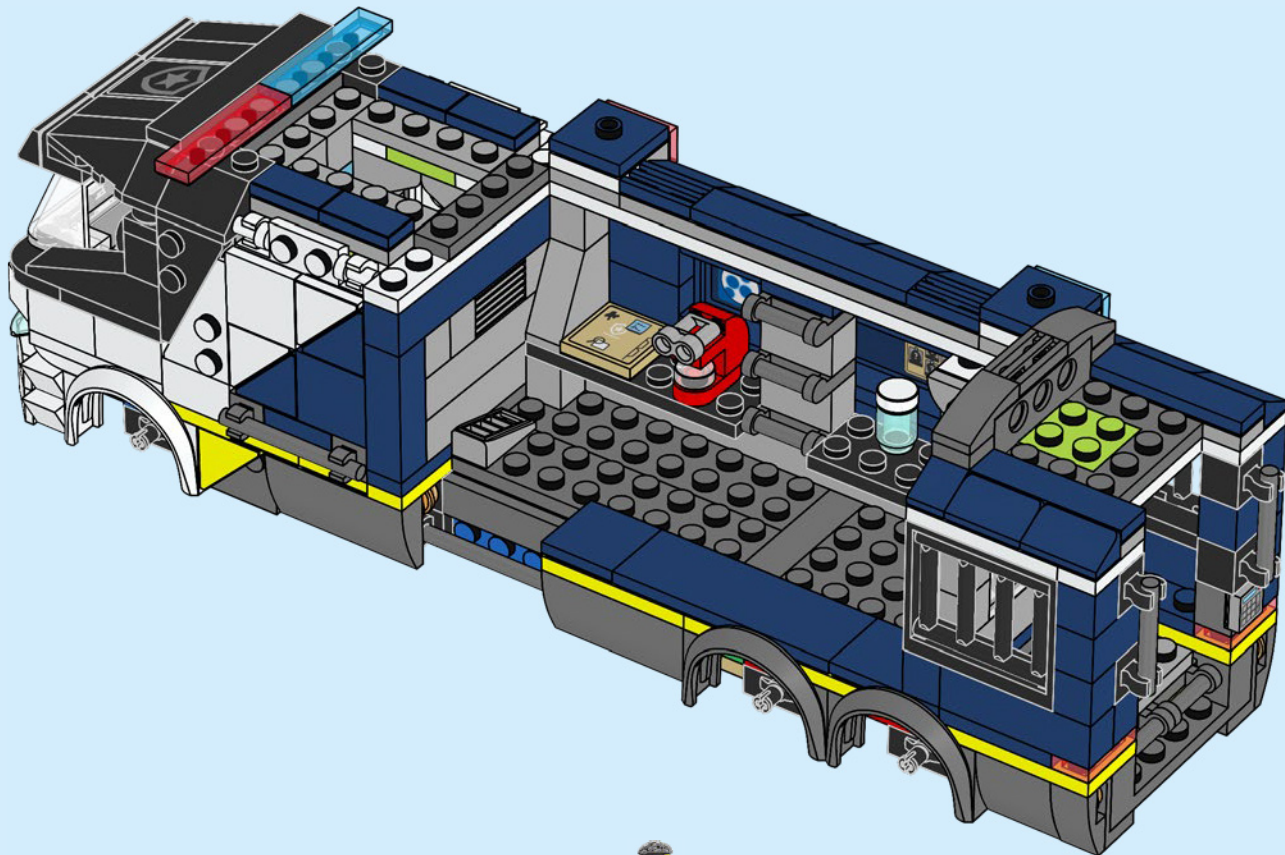

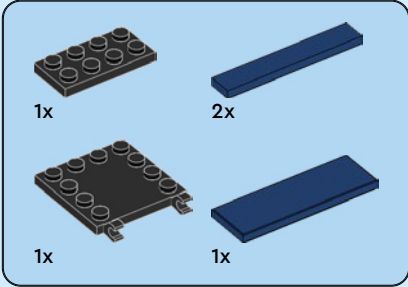
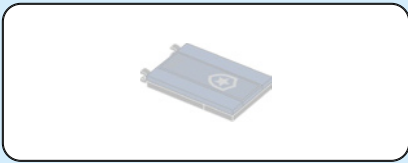

141

1

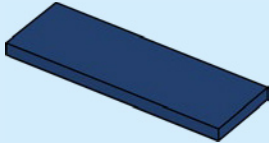

2

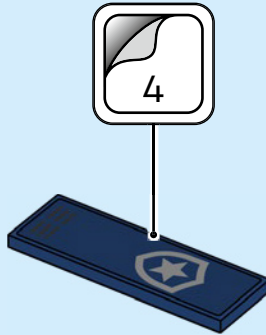

3

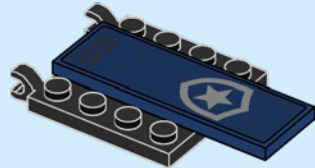

4

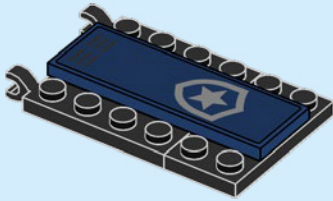

5

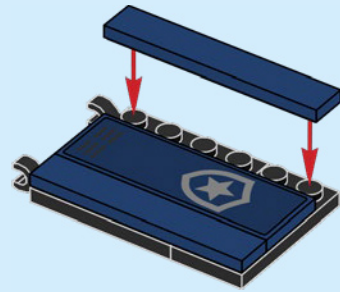

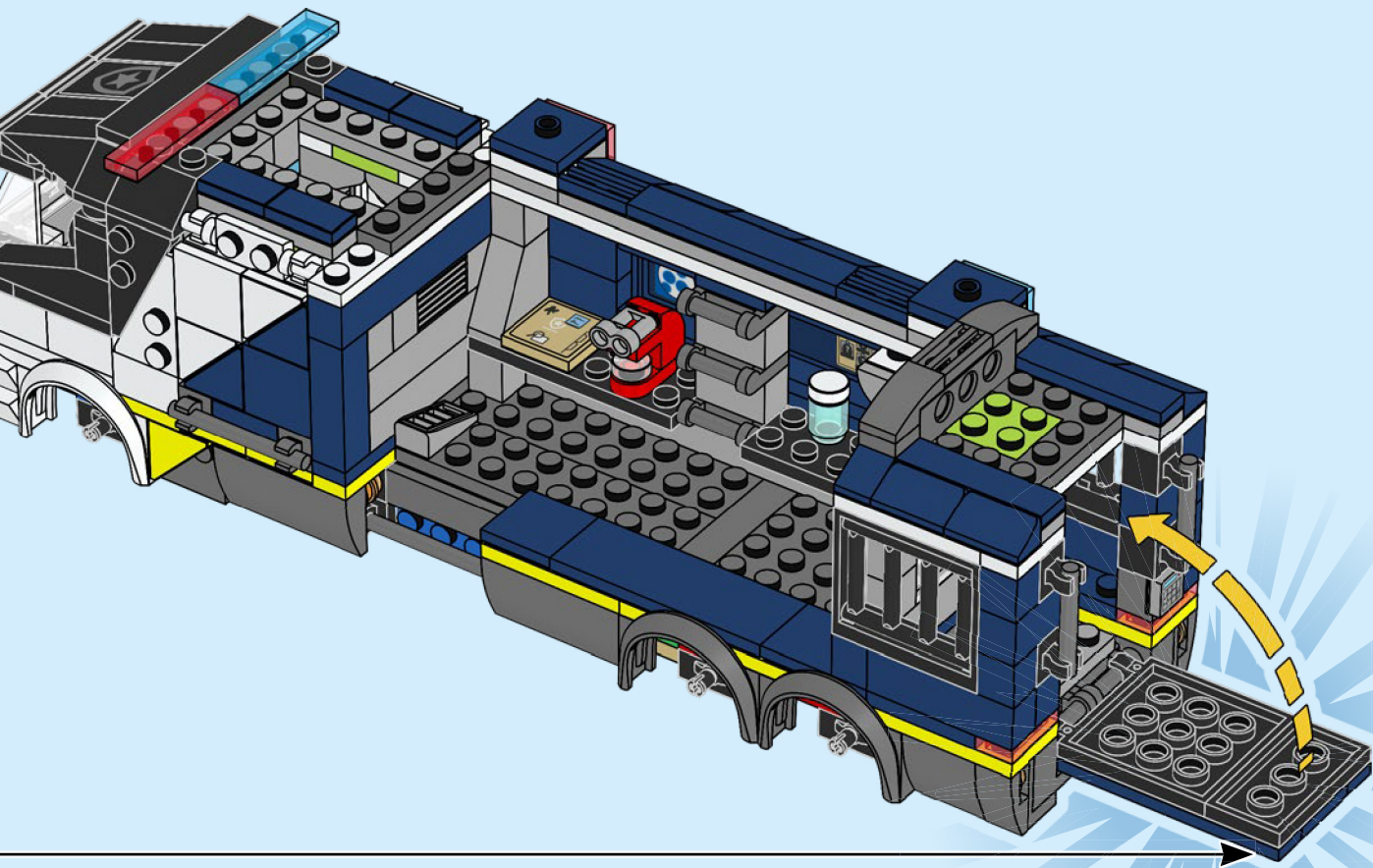

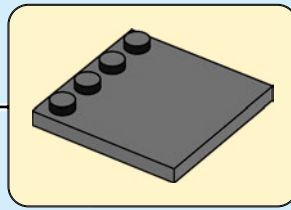
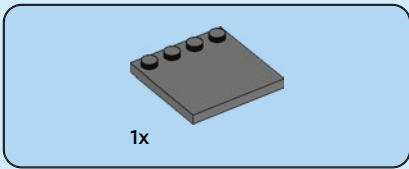

142

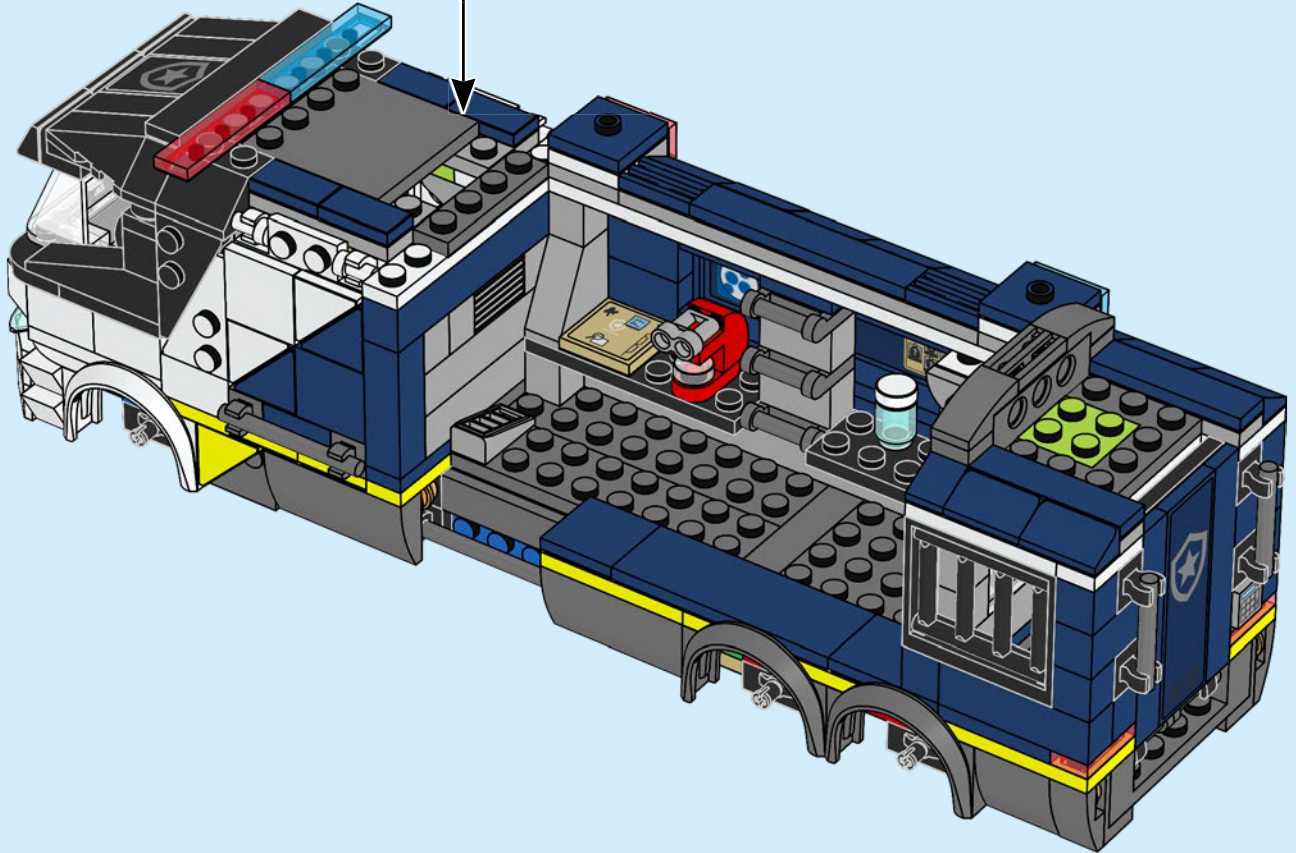

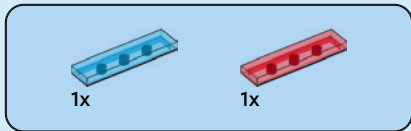

143

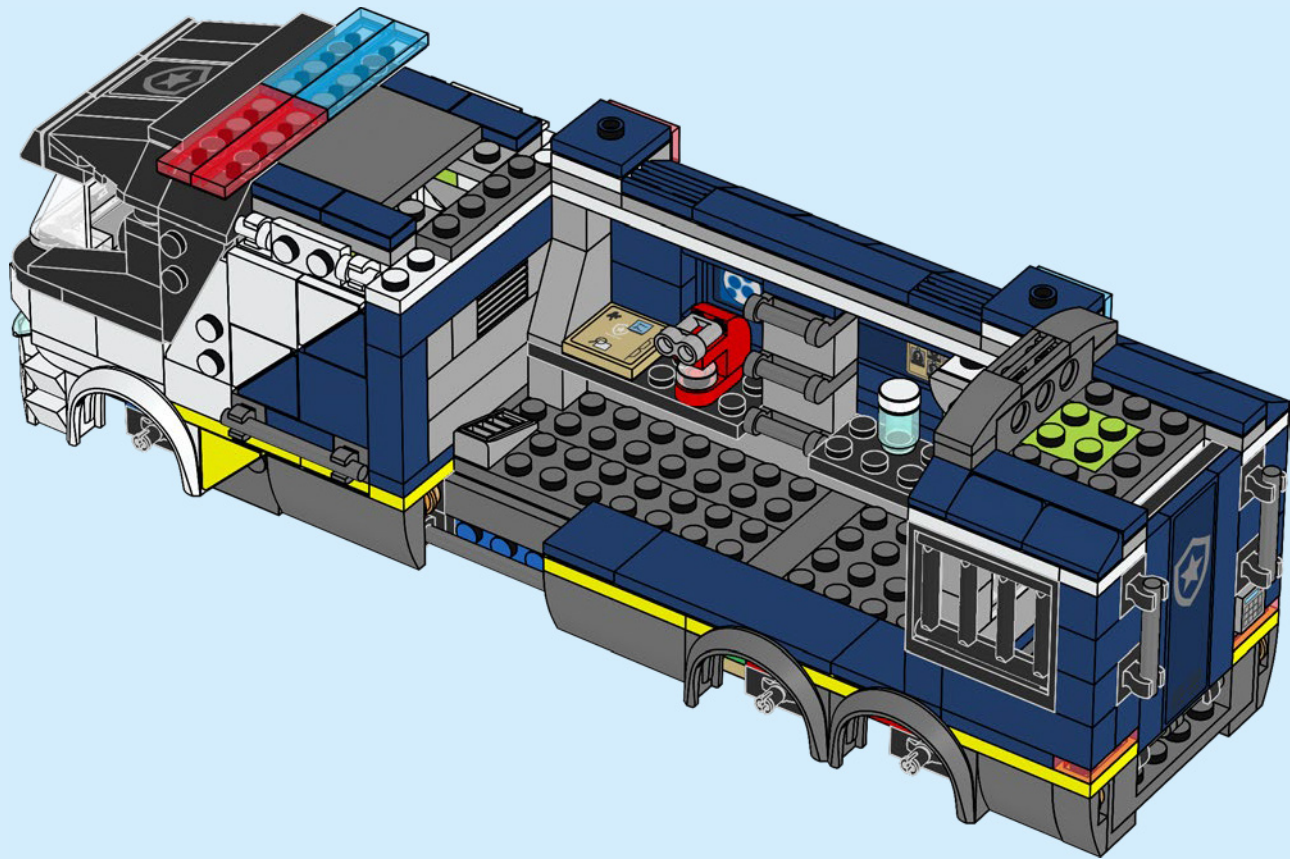



2x

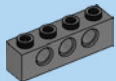

1x

144

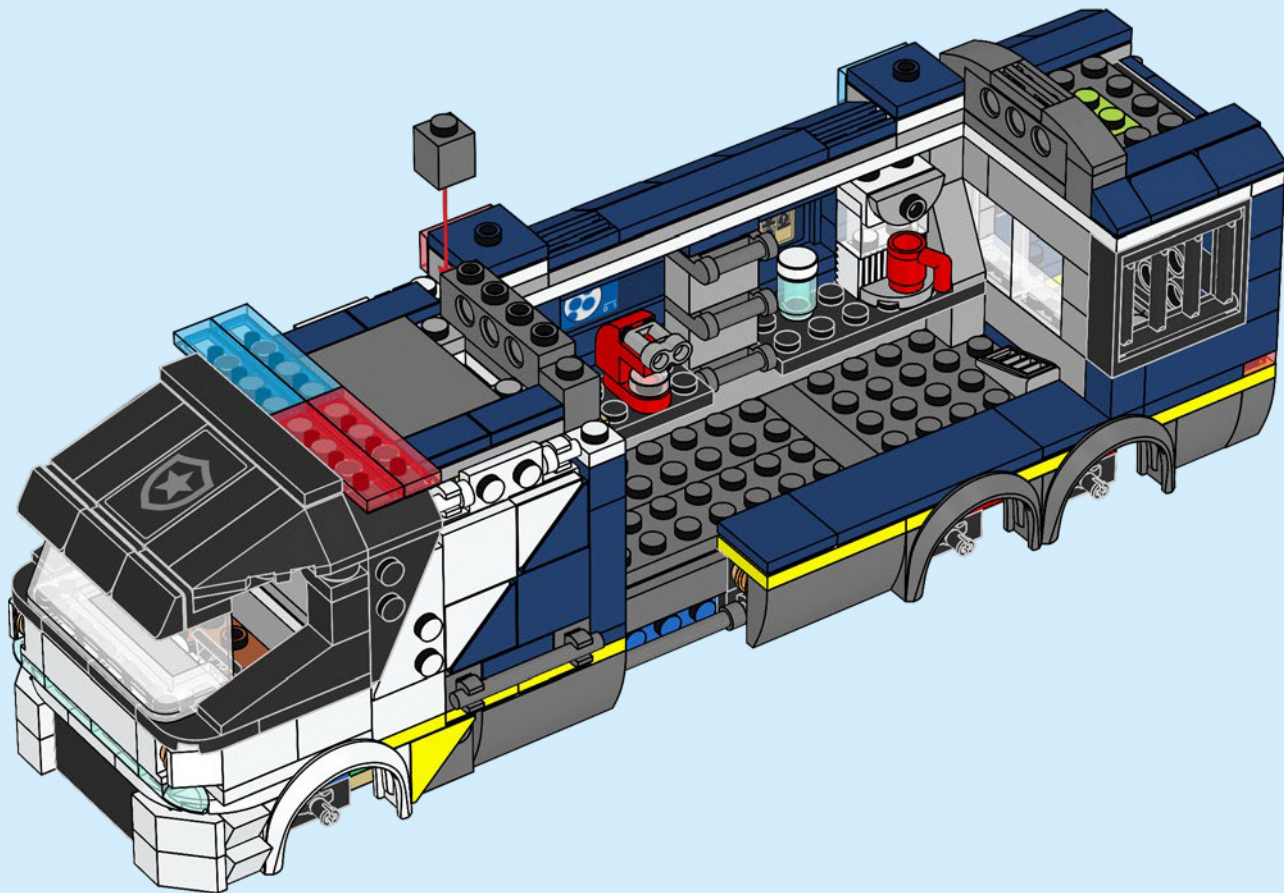



2x

145

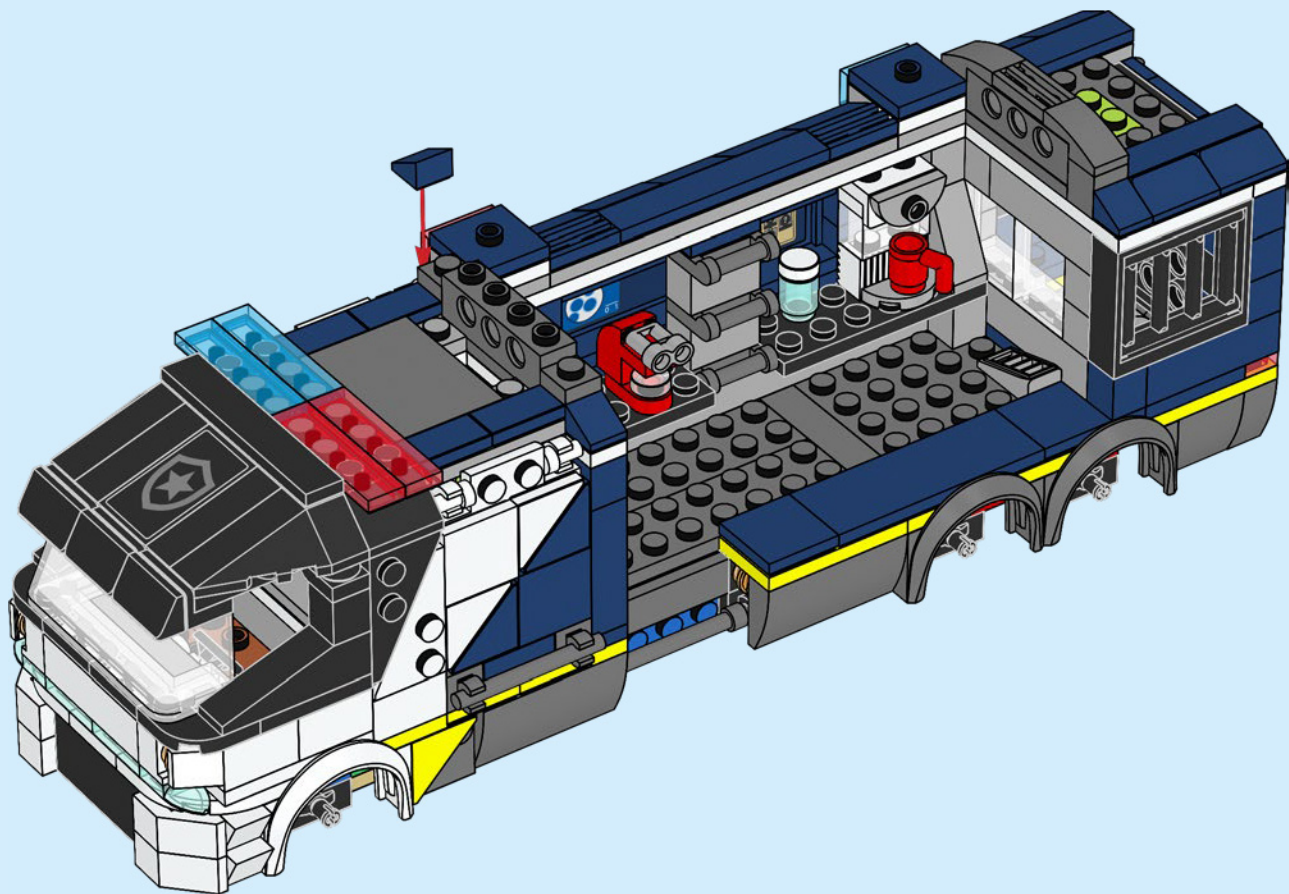



1x



2x

146

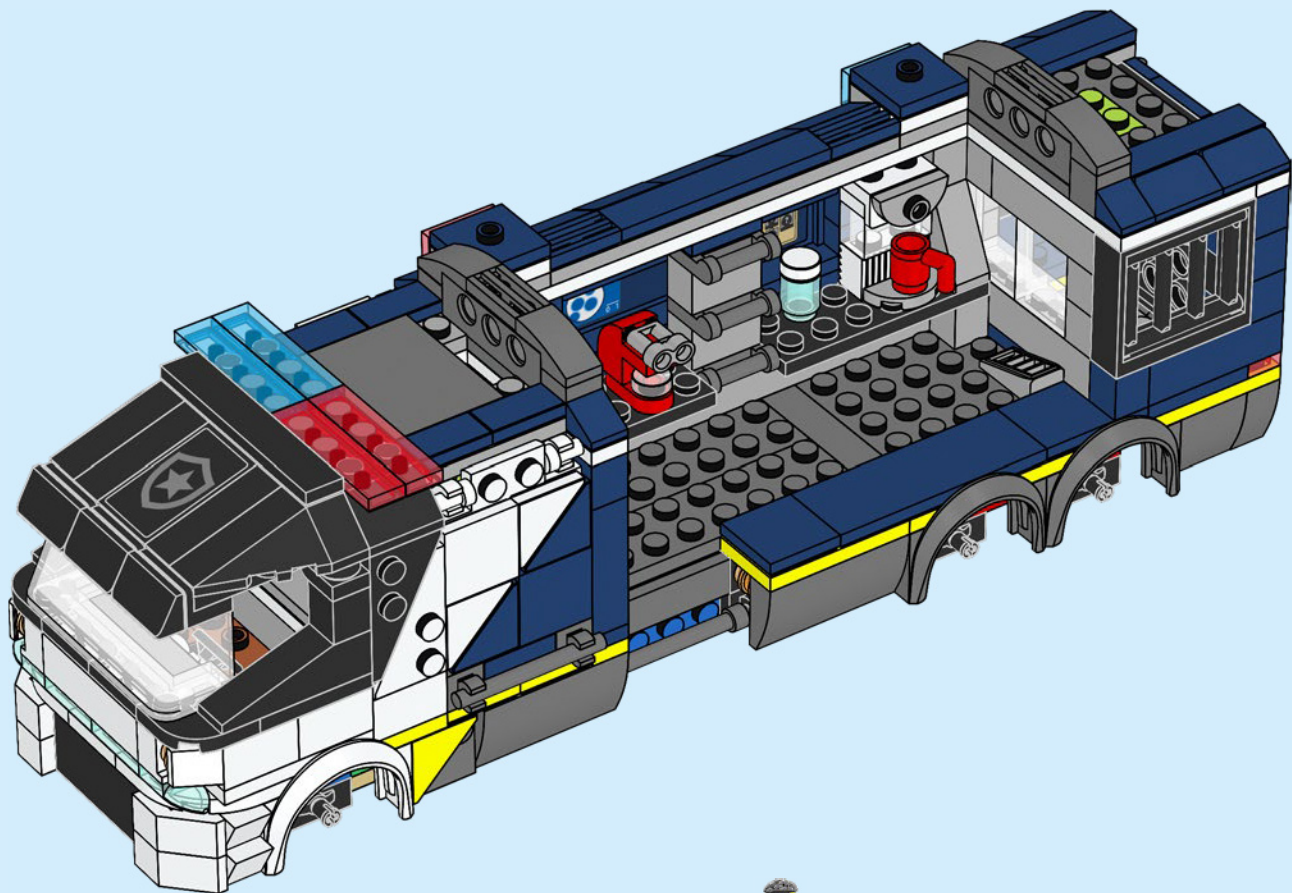

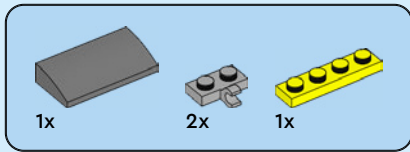

147

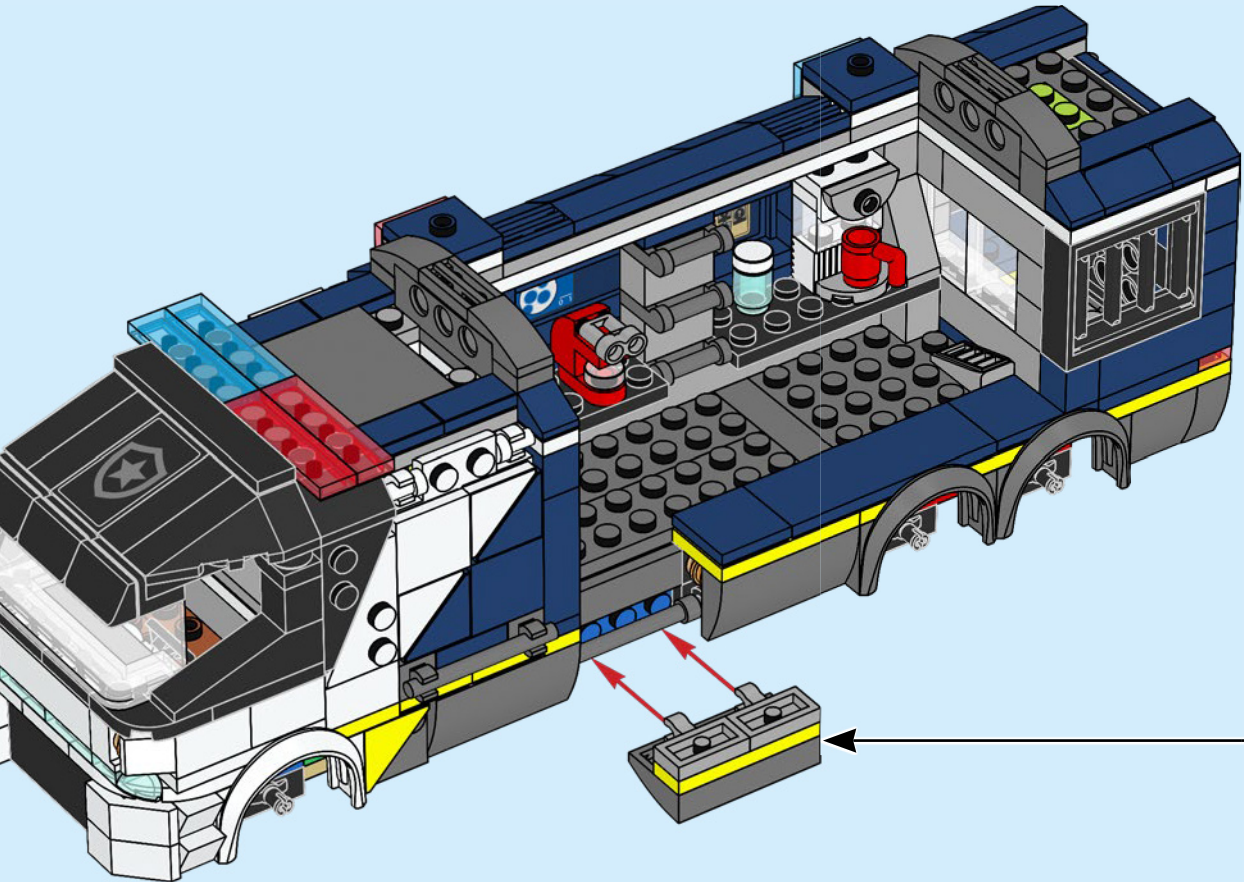
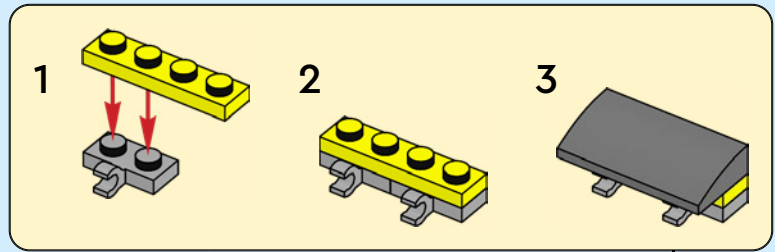

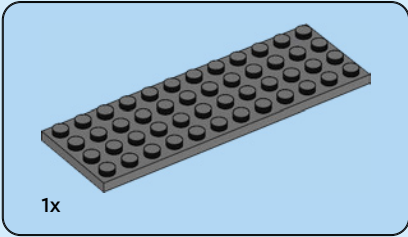
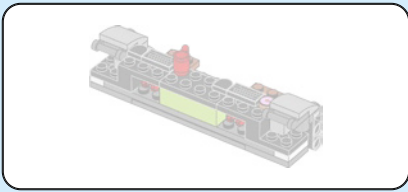

148

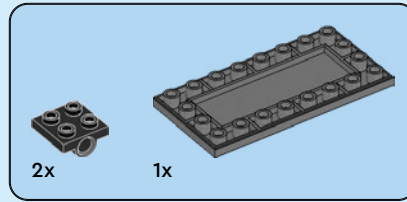
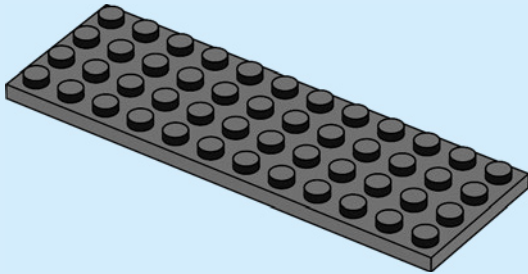

149

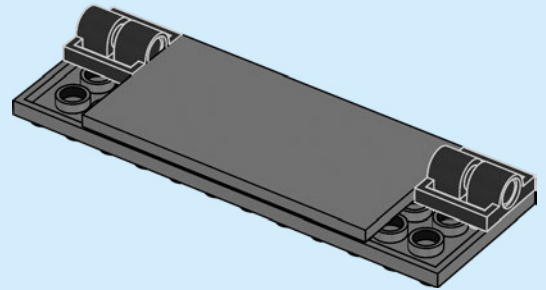
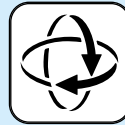

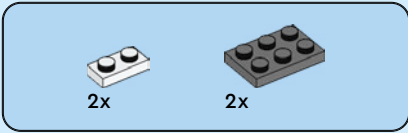

150

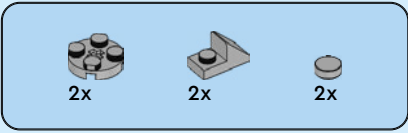
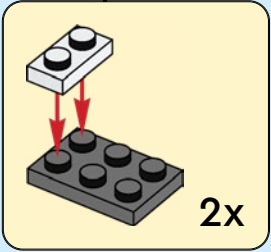
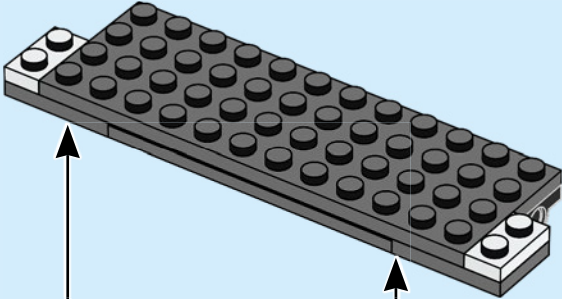

151

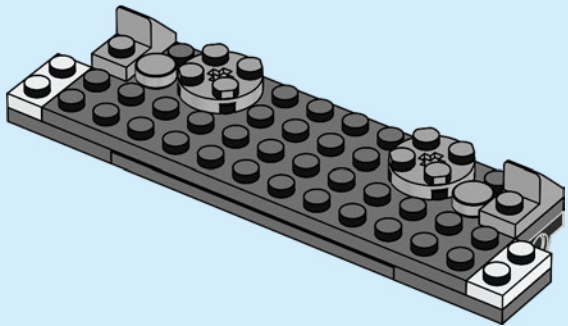



2x

152

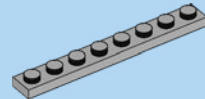
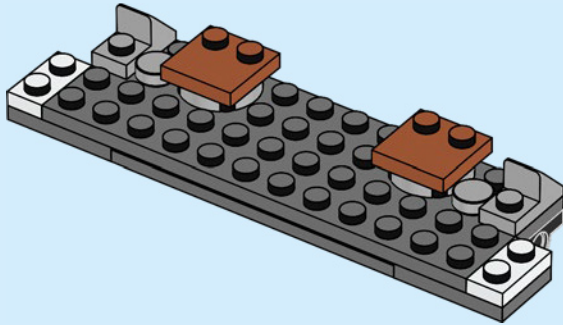

1x

153

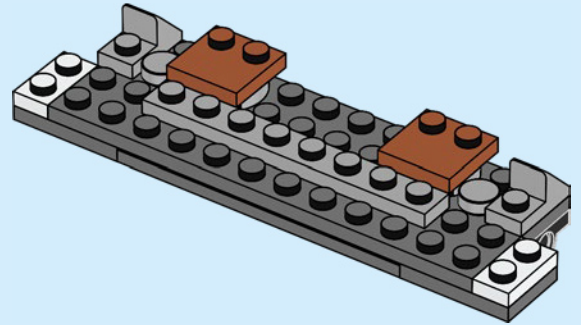

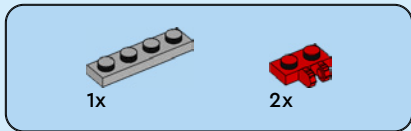

154

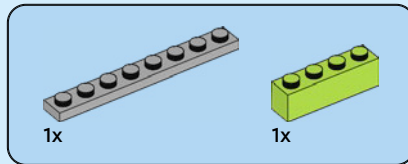
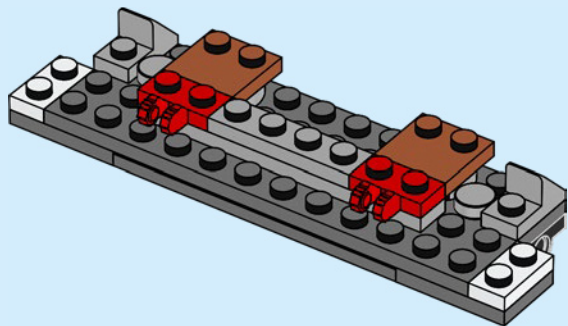

155

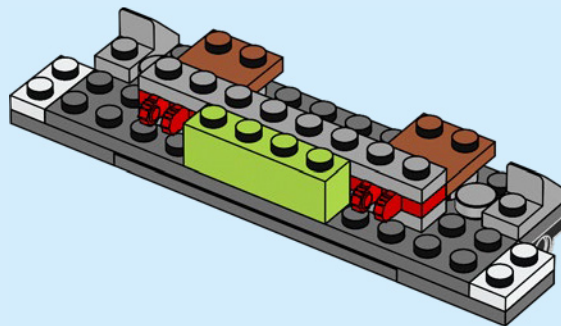

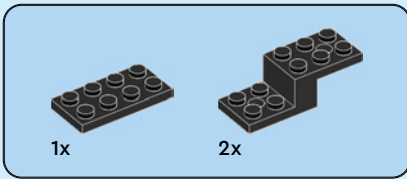

156

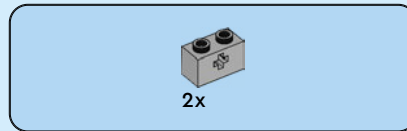
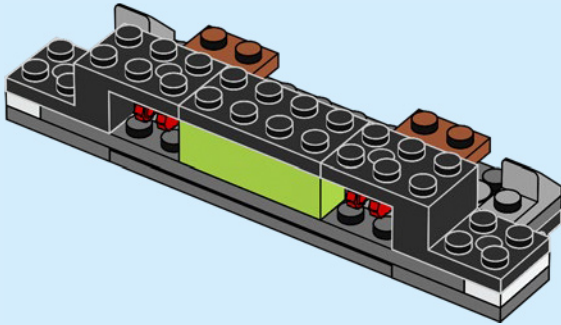

157

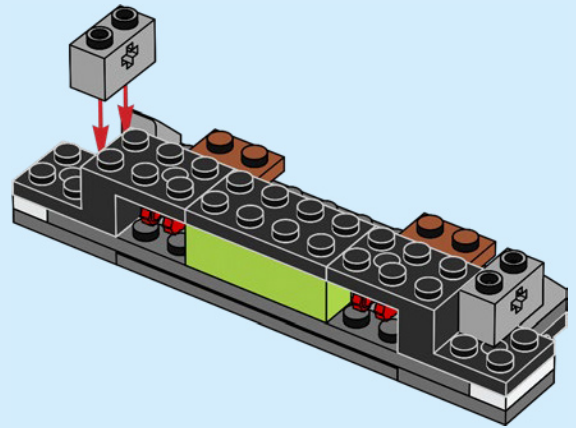



2x

158

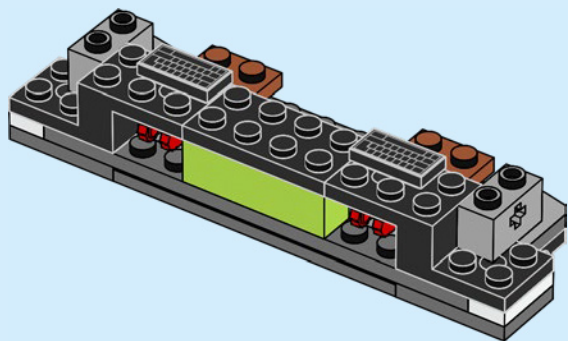

1x



2x



1x

159

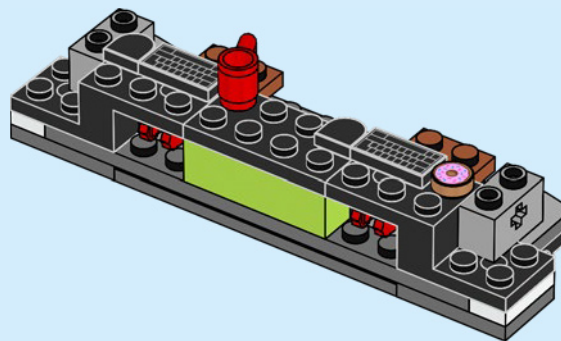



2x



2x

160

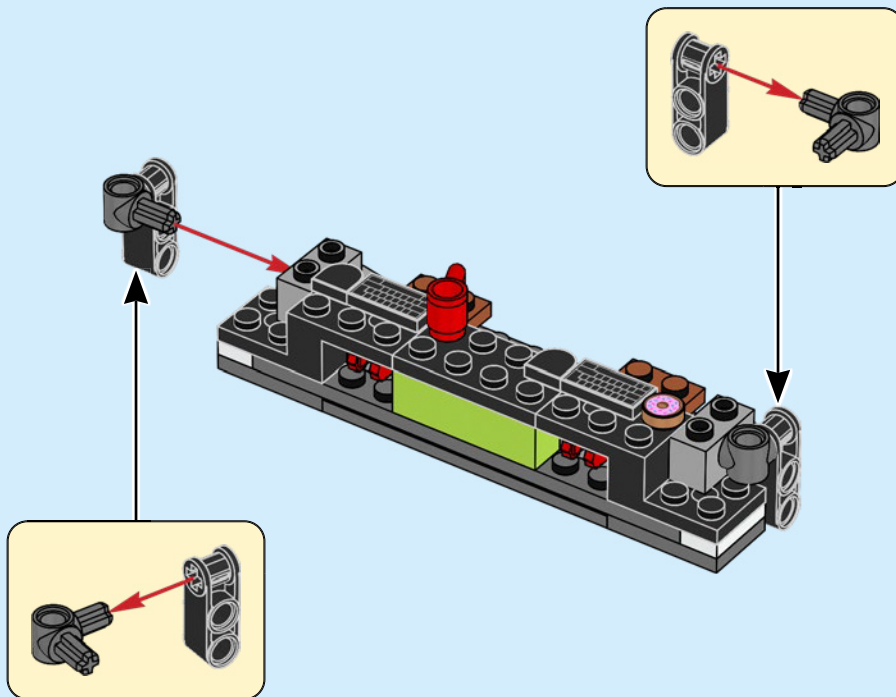

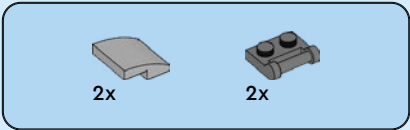

161

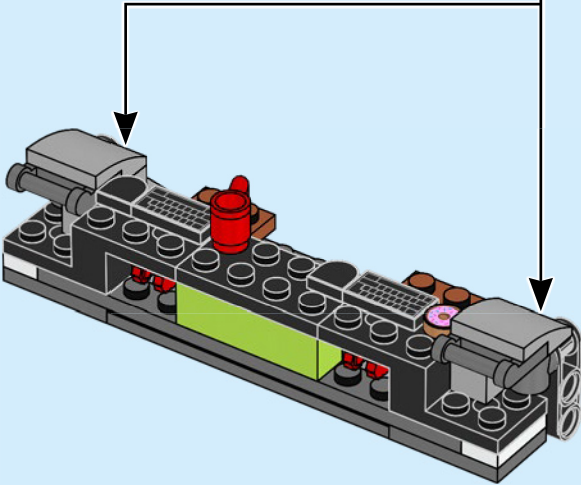
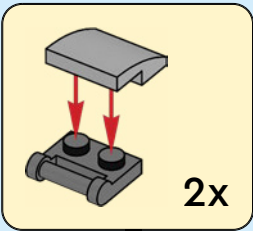

162

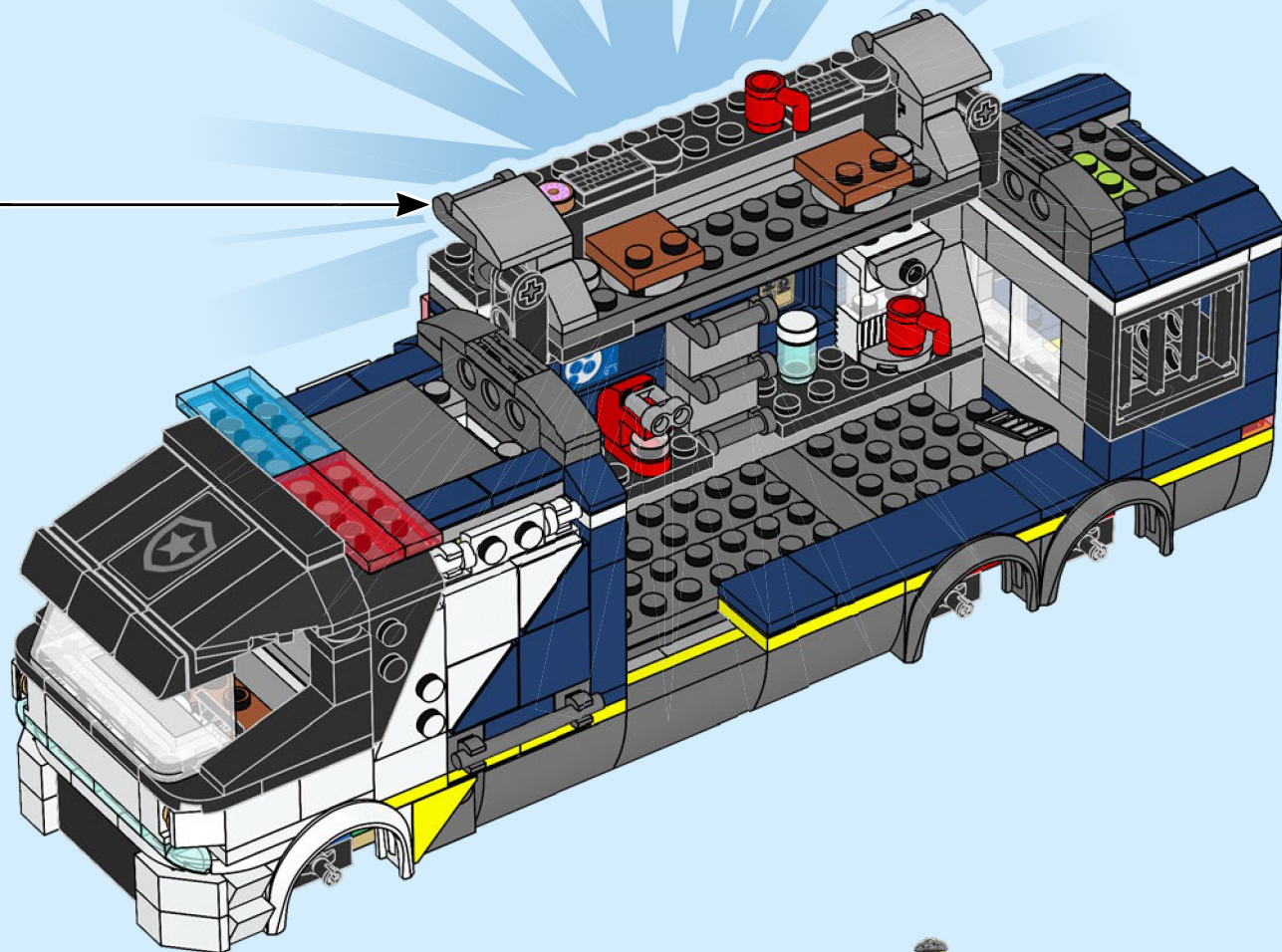

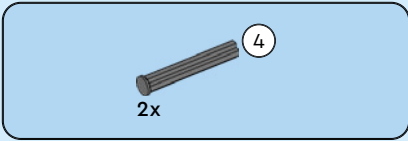

163

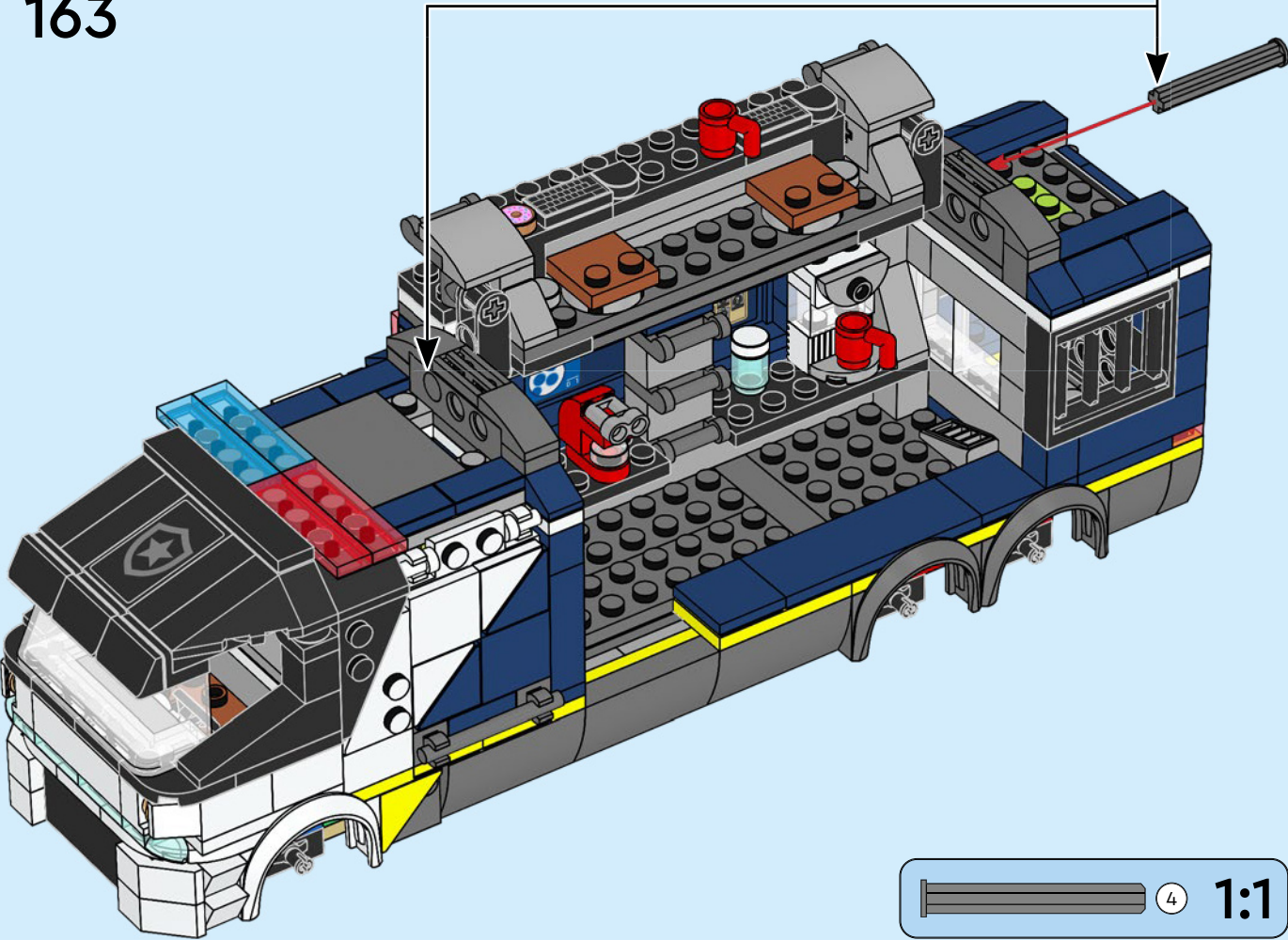
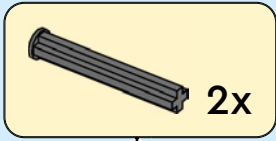

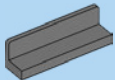

2x

164

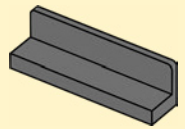

2x

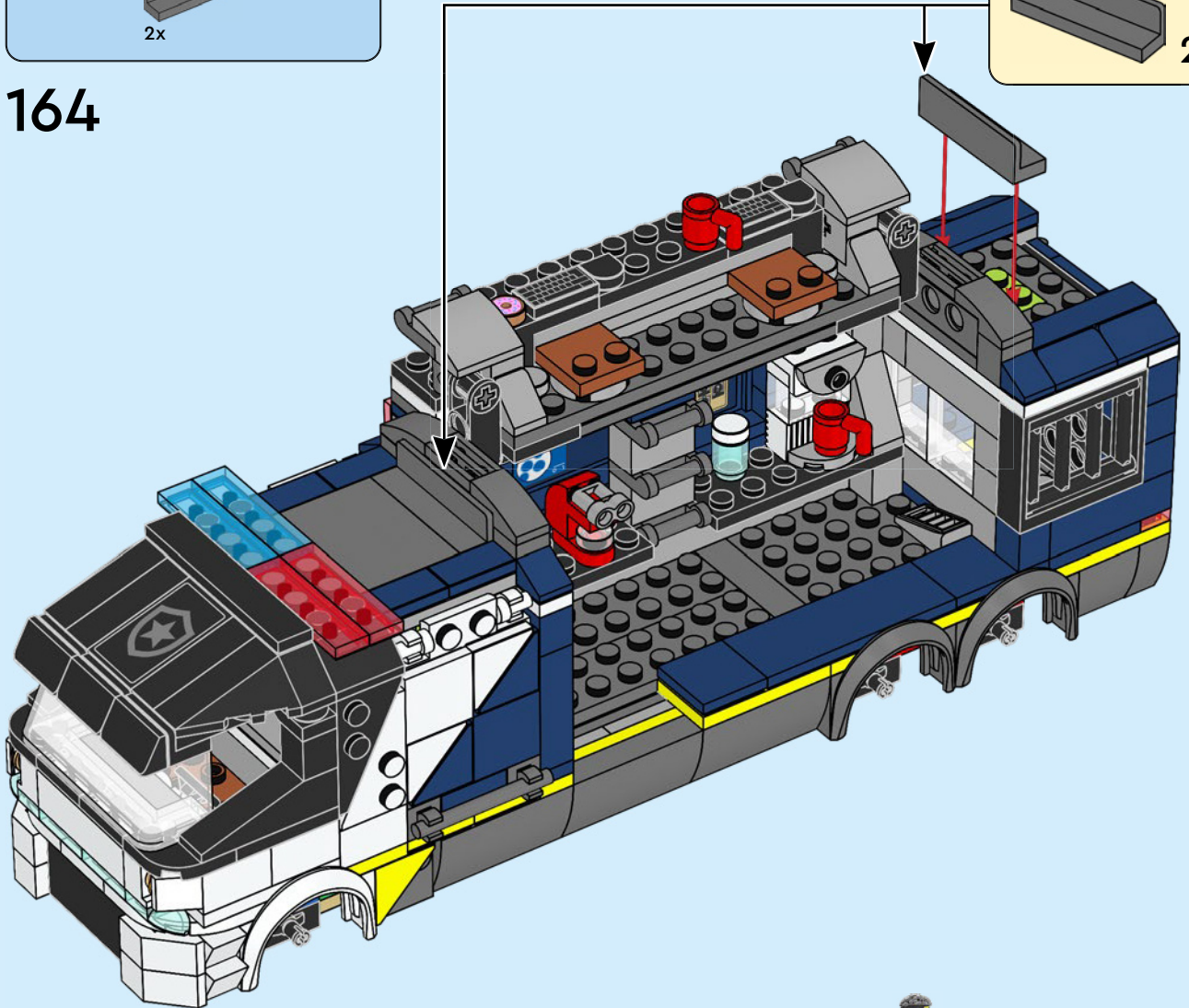

165

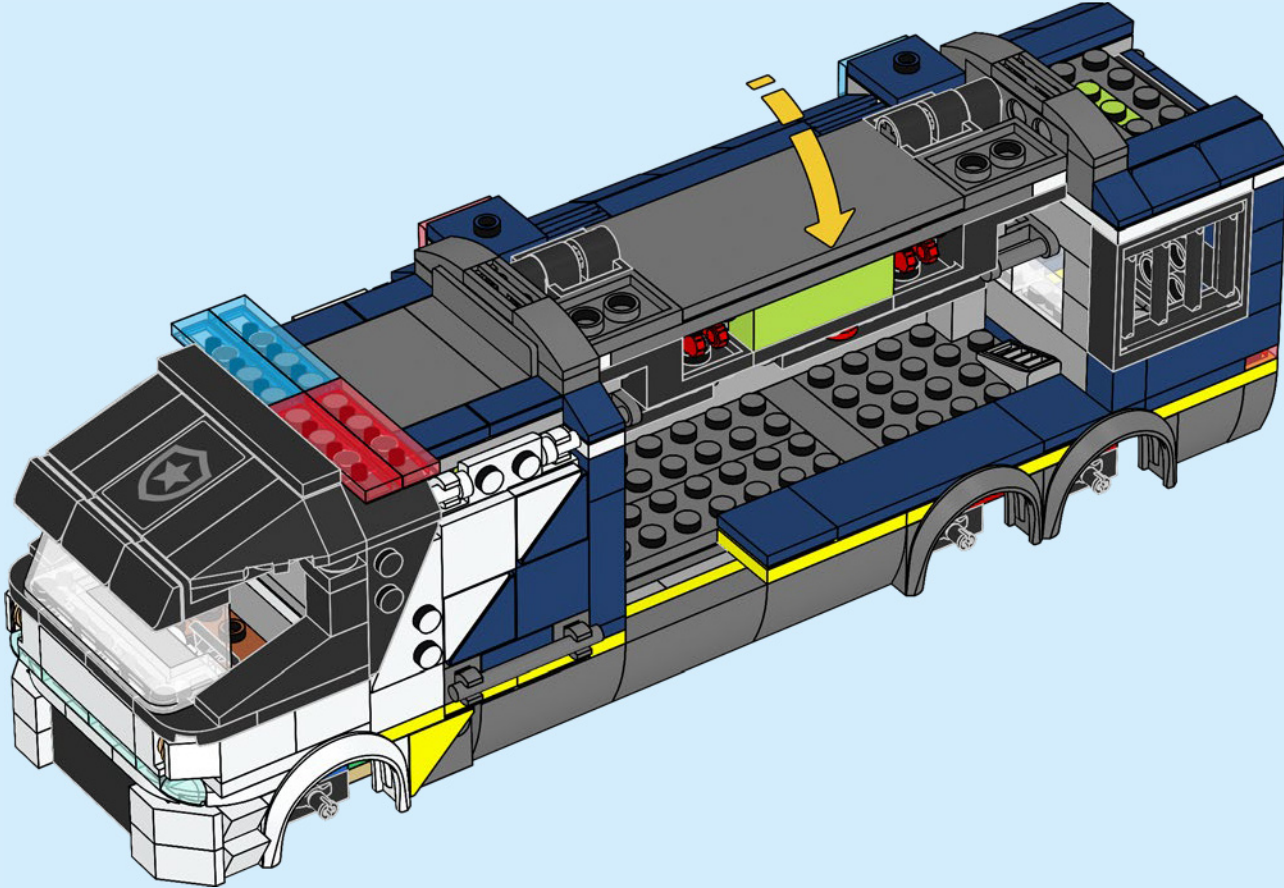

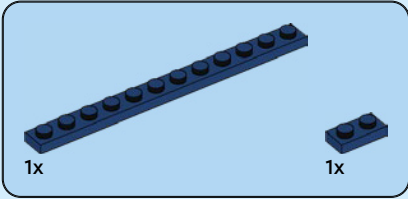
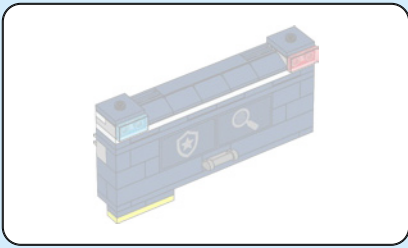

166

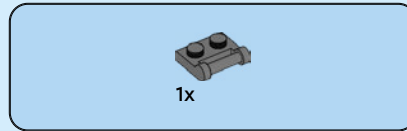
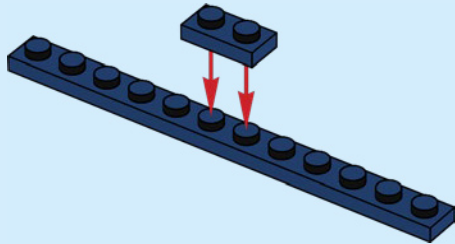

167

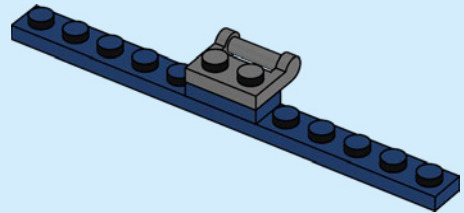

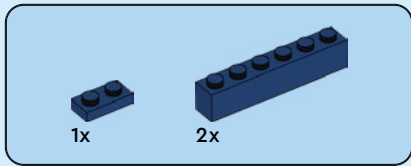

168

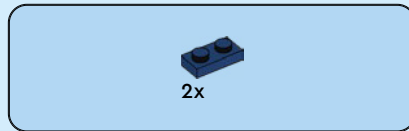
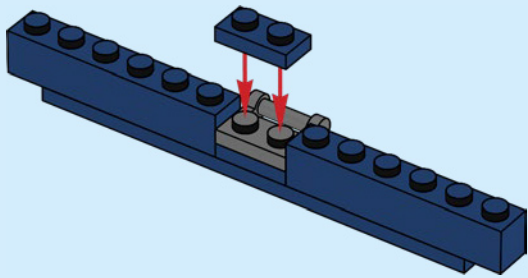

169

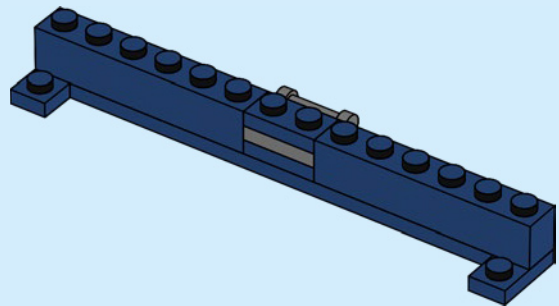



2x

170

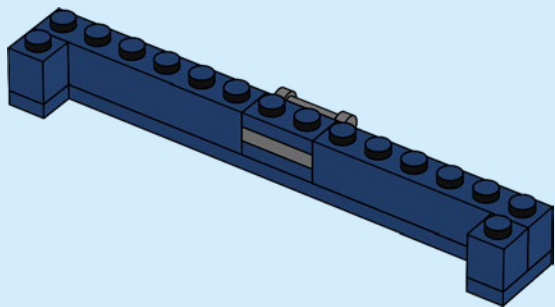

2x



2x

171

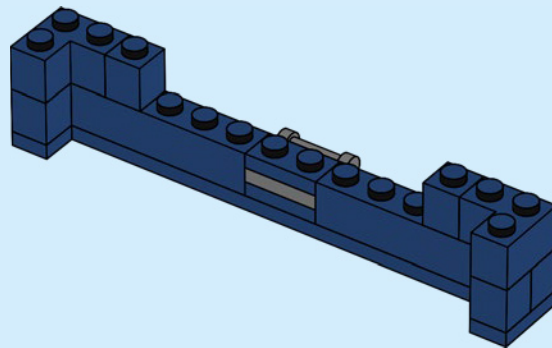

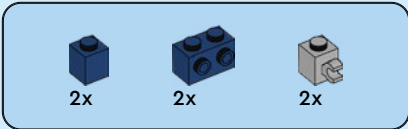

172

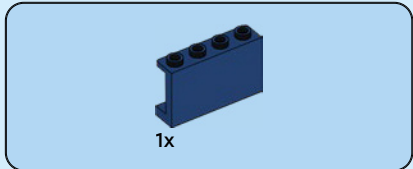
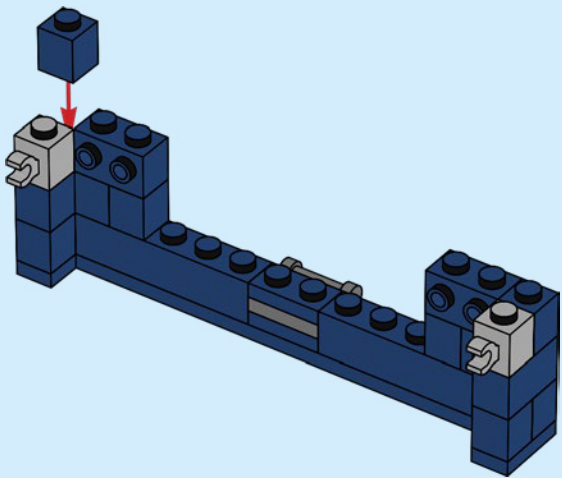

173

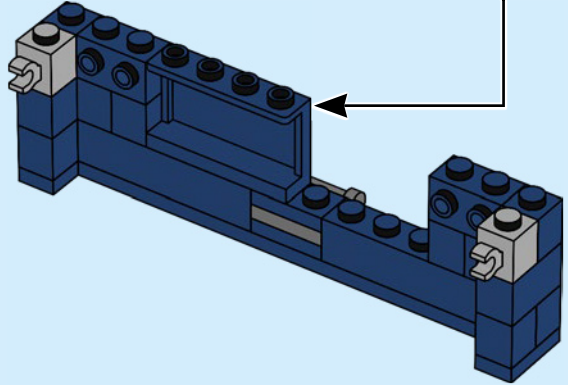
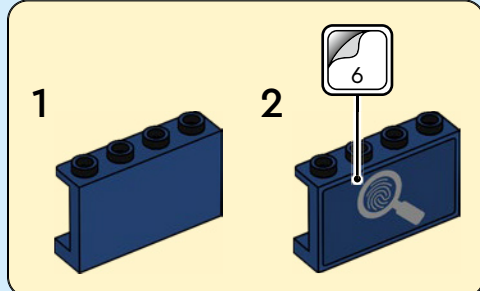

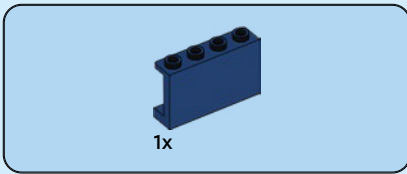

174

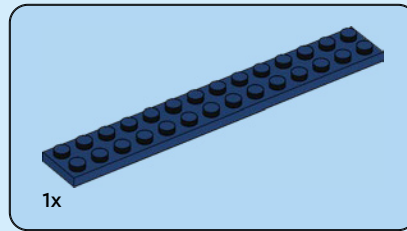
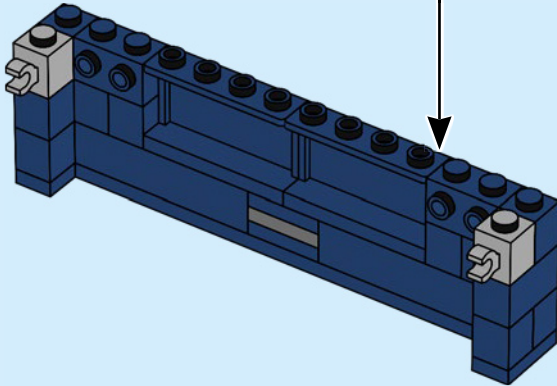
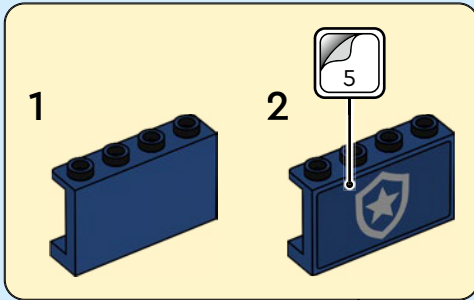

175

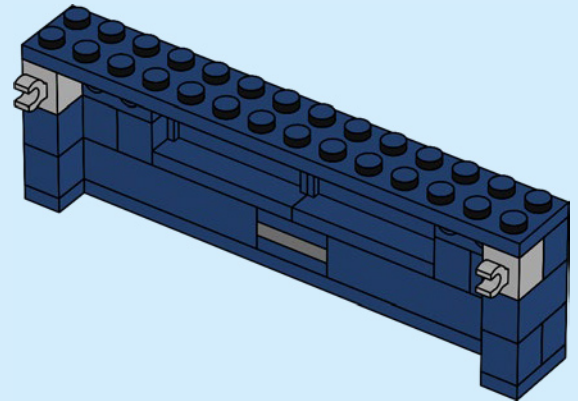

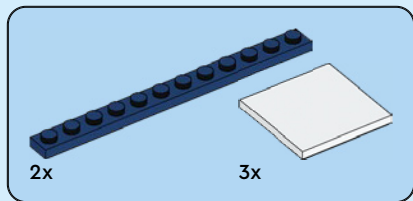

176

1

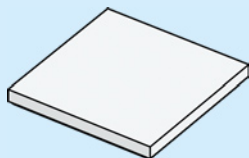

2

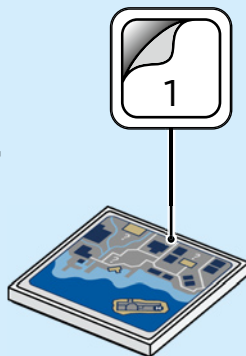

3

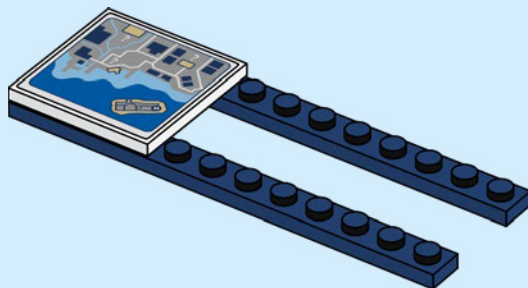

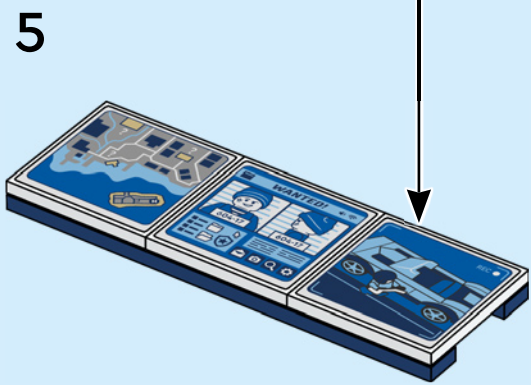
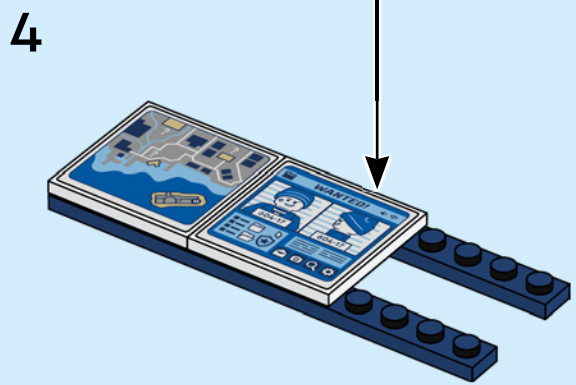
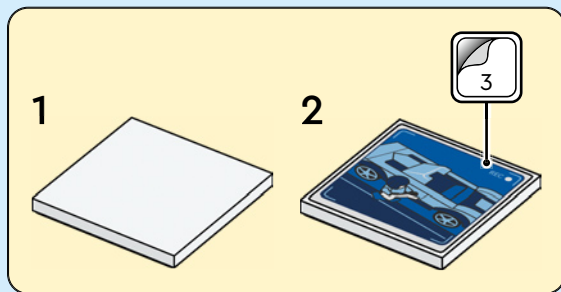
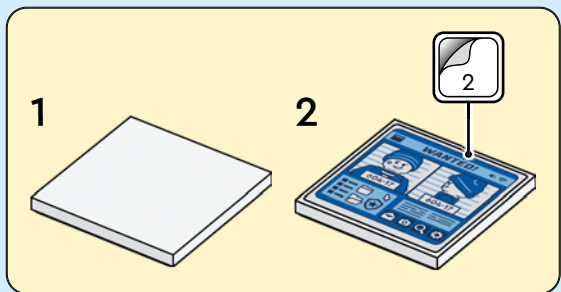



2x



2x



1x

177

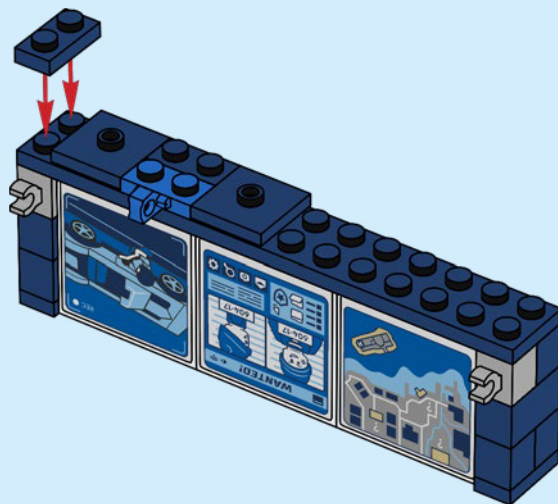
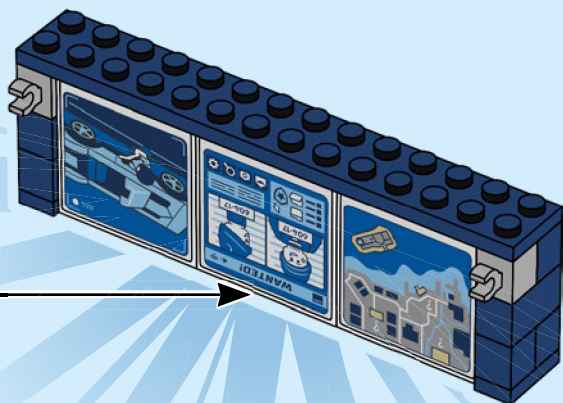

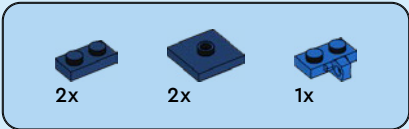

178

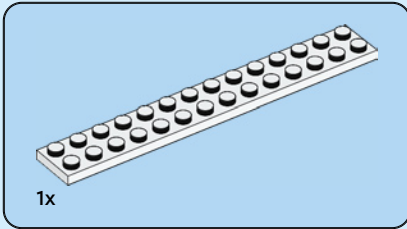
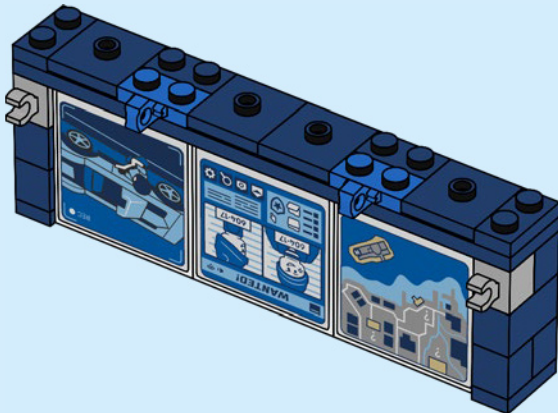

179

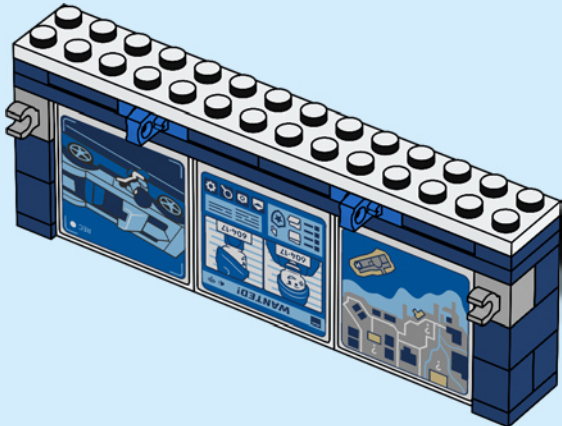



2x

180

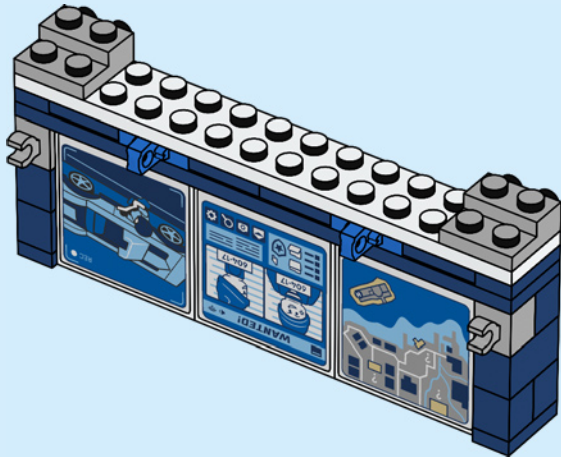

5x

181

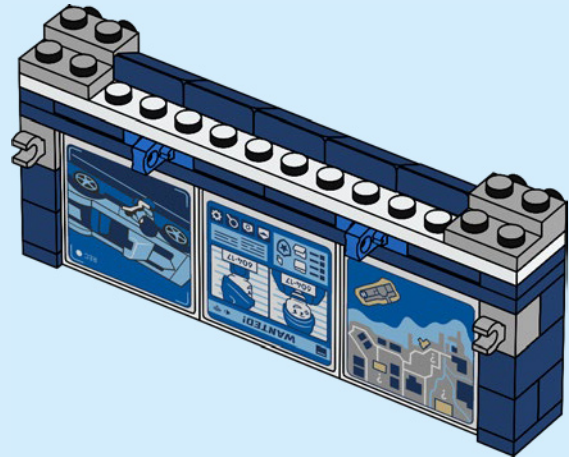

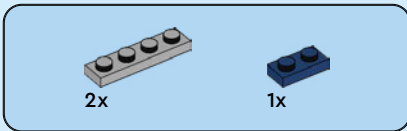

182

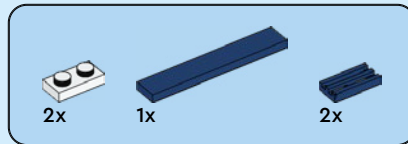
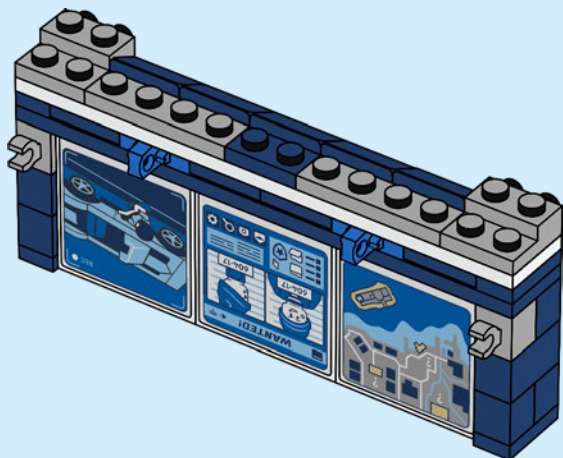

183

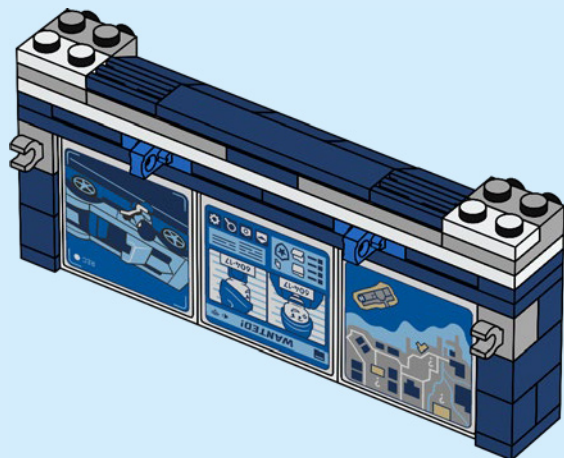

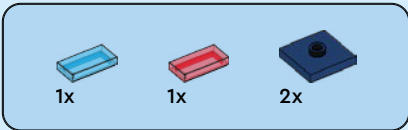

184

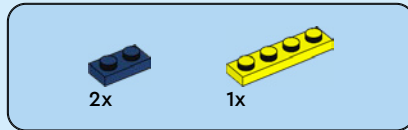
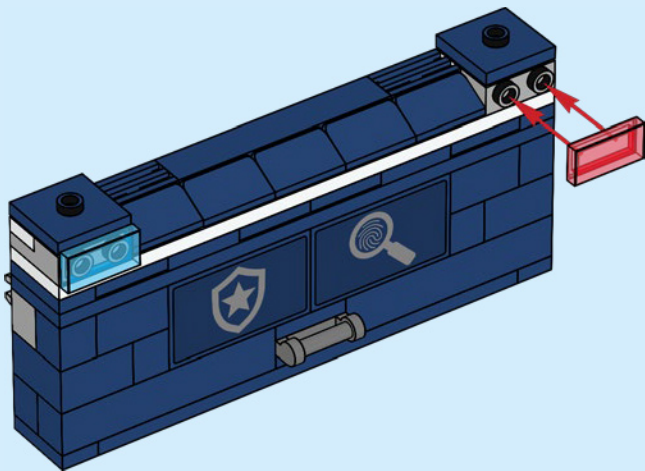

185

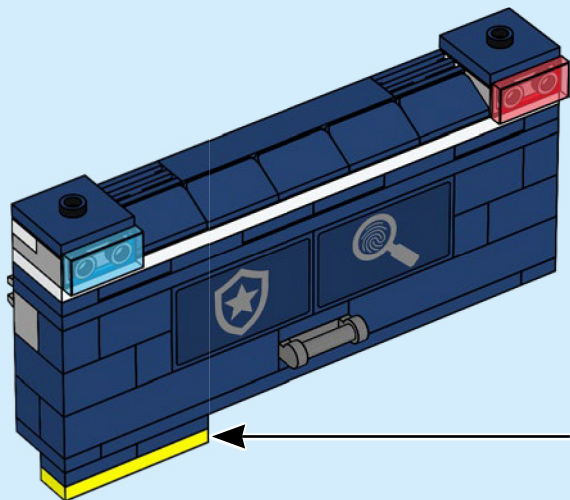
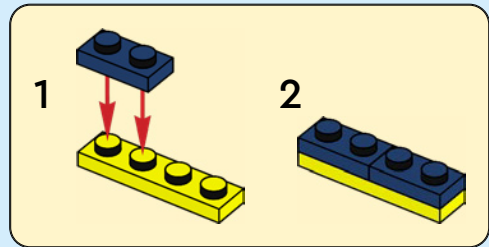

186

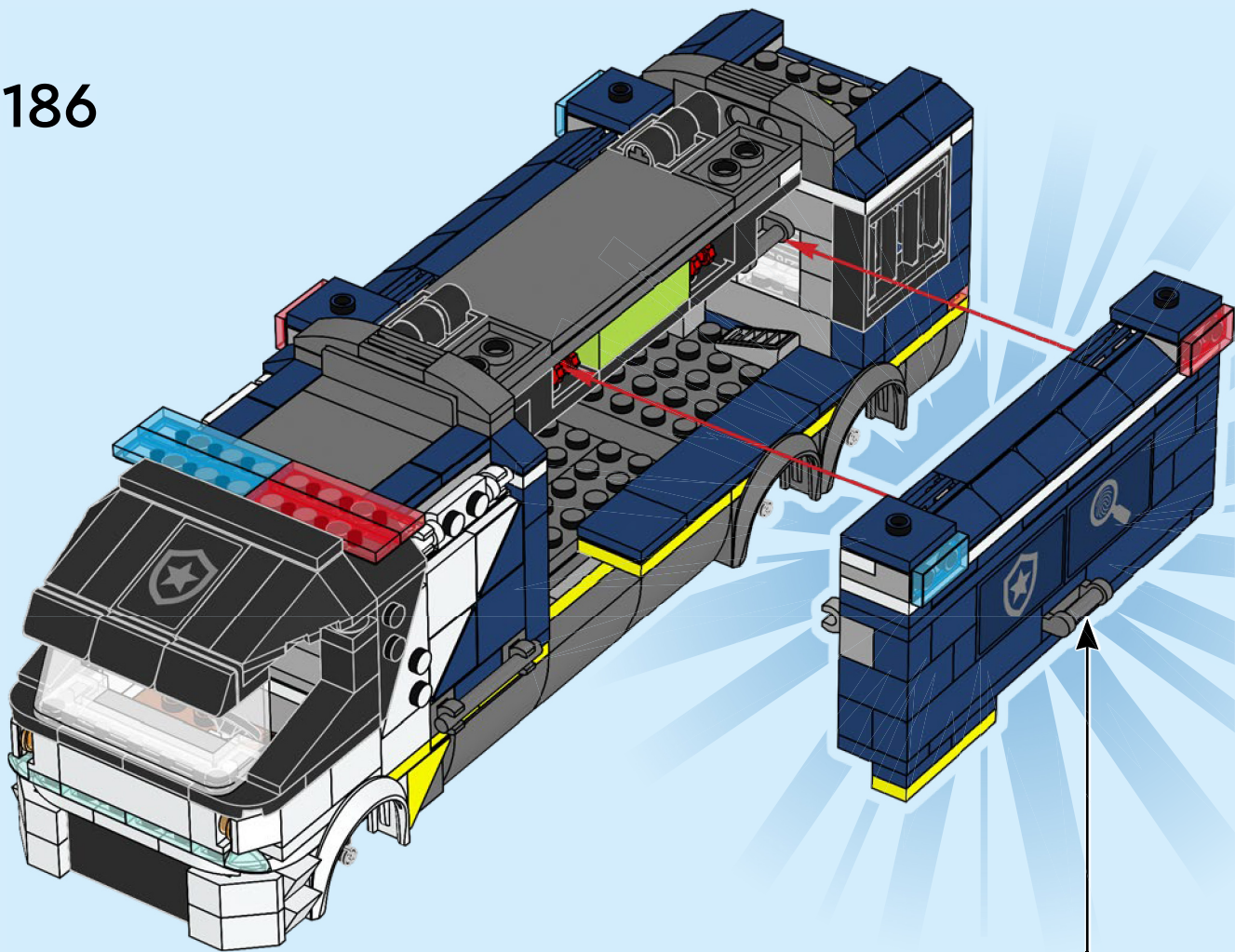

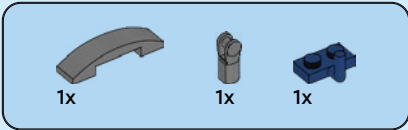

187

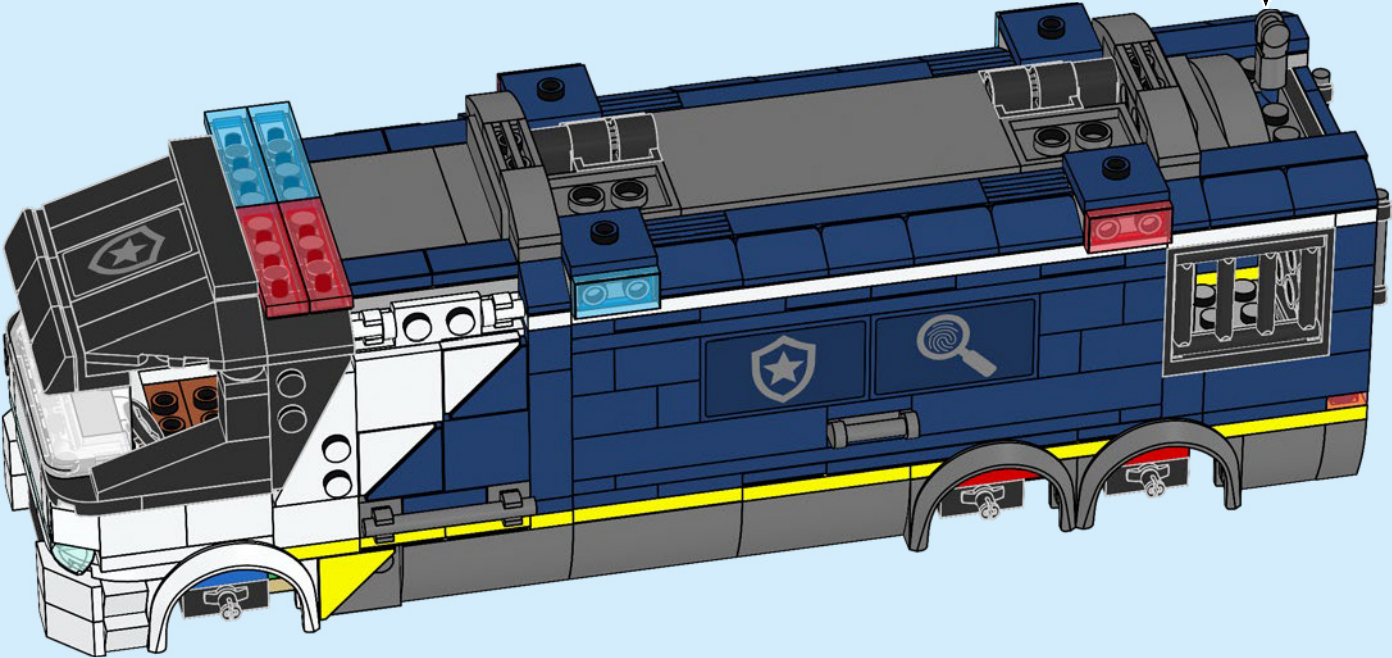
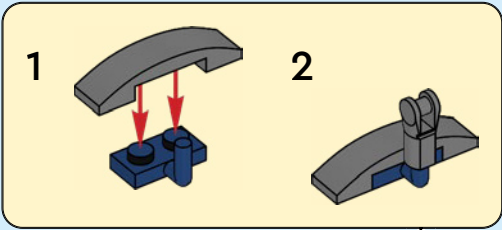

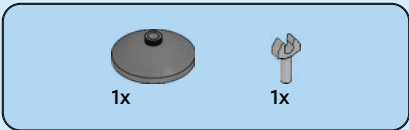

188

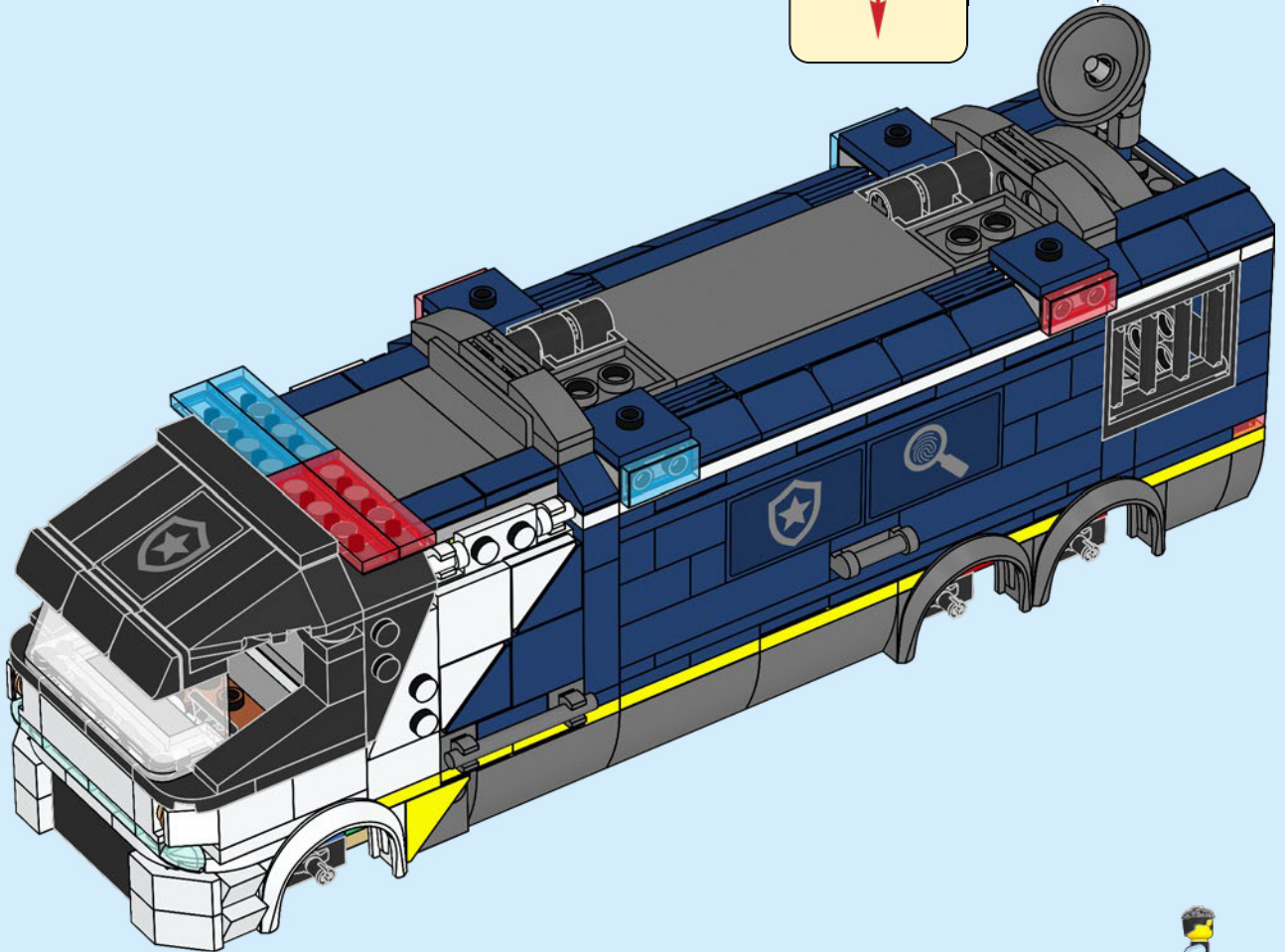
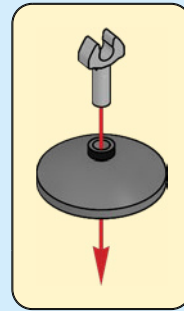

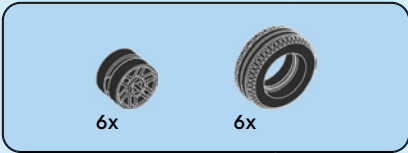

189

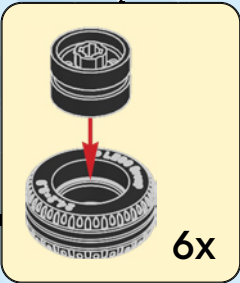
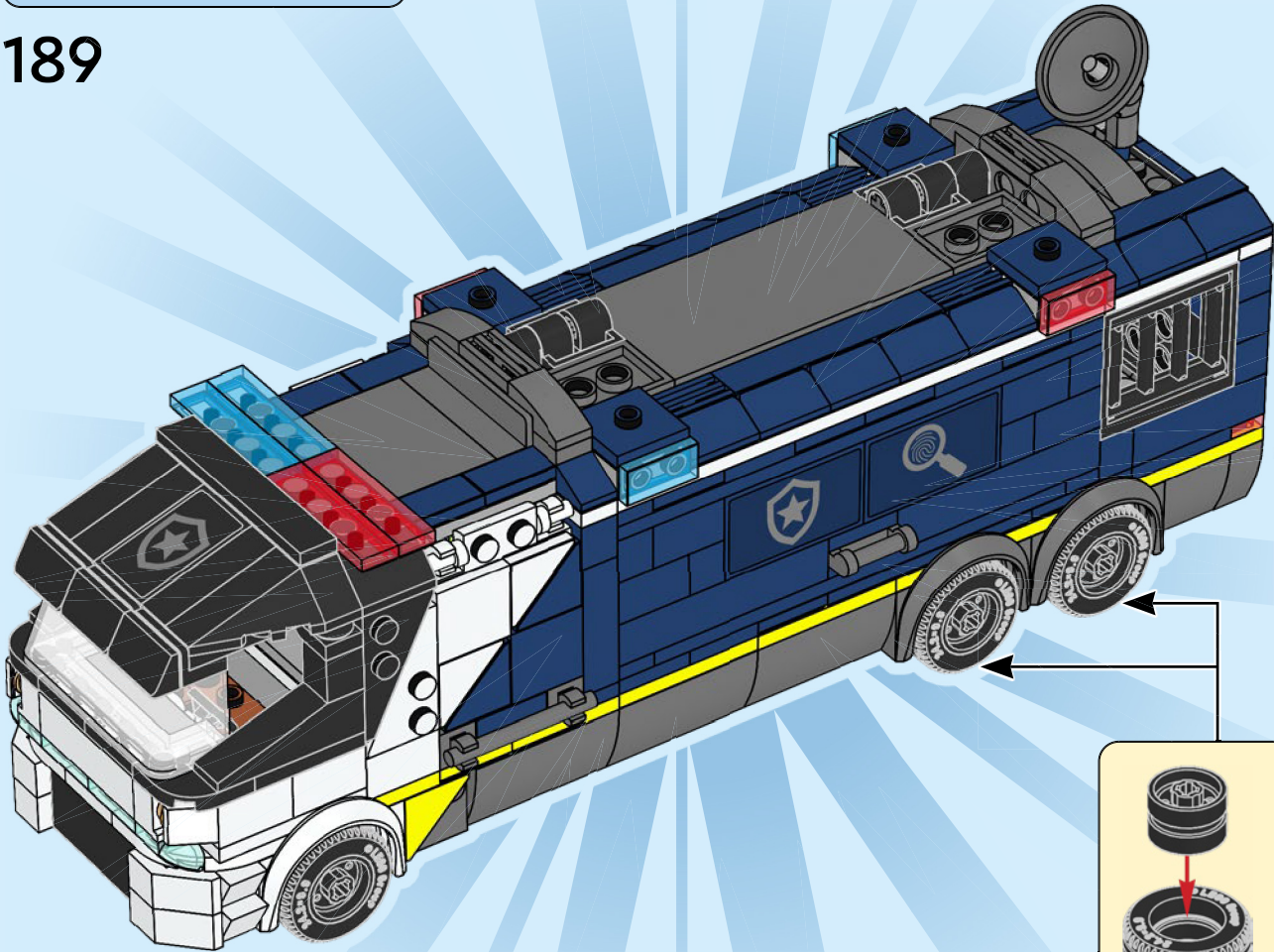

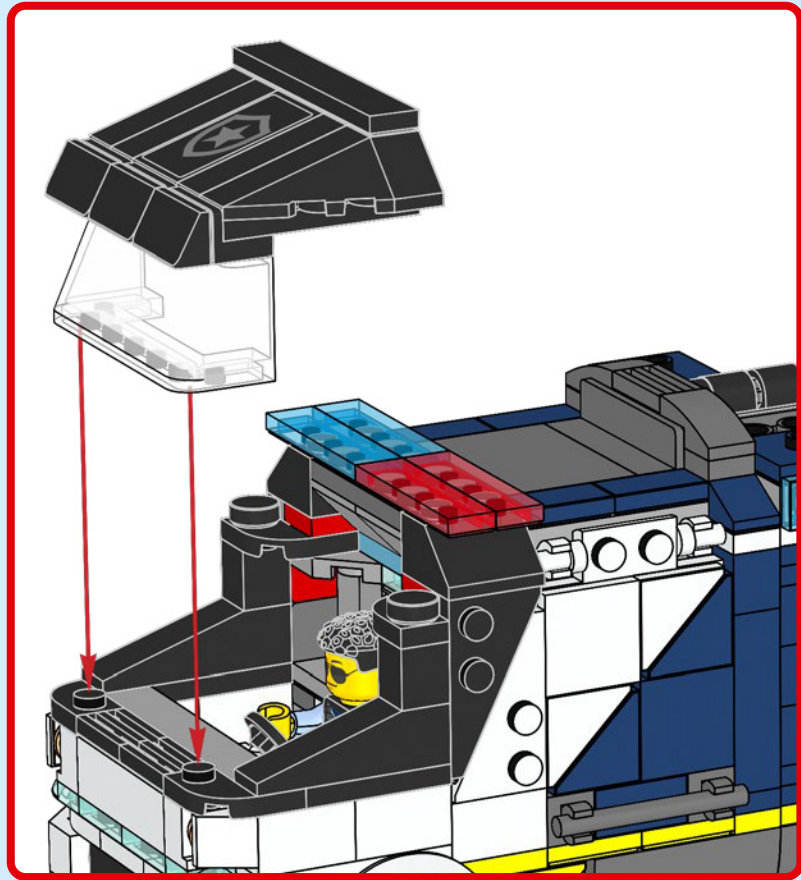







CITY

60418



60415



60419



60414



60413



1x
4599453



2x
389921

1x
6210269

1x
6184782

2x
6266205

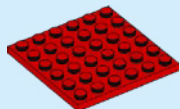
11x
6117974



1x
4144302

2x
6274738

2x
6251294

1x
6244904

2x
6253231

1x
6245195

1x
6341463

1x
4525464

1x
6174813

1x
6283884

1x
6465455

1x
6112622

1x
6174454

4x
6469827



1x
4140587



1x
6126050

1x
6116606

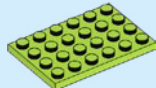
7x
4537937

2x
4234716

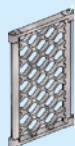
1x
6060848



3x
6469206

2x
6284070

2x
6256435

2x
300526

1x
6356861

4x
6336977

1x
6472859

1x
6325525

1x
6295295

1x
6295293

3x
4548180

1x
6476480

10x
6288175

1x
6308912

1x
302326

1x
6329698

2x
6347310

2x
241226

1x
9551

2x
6403650

3x
6020193

1x
3003126

4x
6029208

2x
6273708

2x
302226

1x
6053077

6x
6482959

4x
6430580

2x
303926

2x
281726

6x
6457145

2x
362326

1x
6470970

2x
4521681

2x
4530589

4x
4515362

1x
6040298

2x
6325276

3x
302026

3x
4560182

1x
6040297

1x
4185583

2x
6039194

1x
663626

2x
6064228

1x
6310190

2x
379526

1x
303226

2x
4107558

2x
6261357

1x
4185177

9x
6395373

1x
6294227

3x
6135287

2x
6210271

3x
6411022

16x
302328



1x
302128

2x
4120158

1x
6126063

1x
6471281

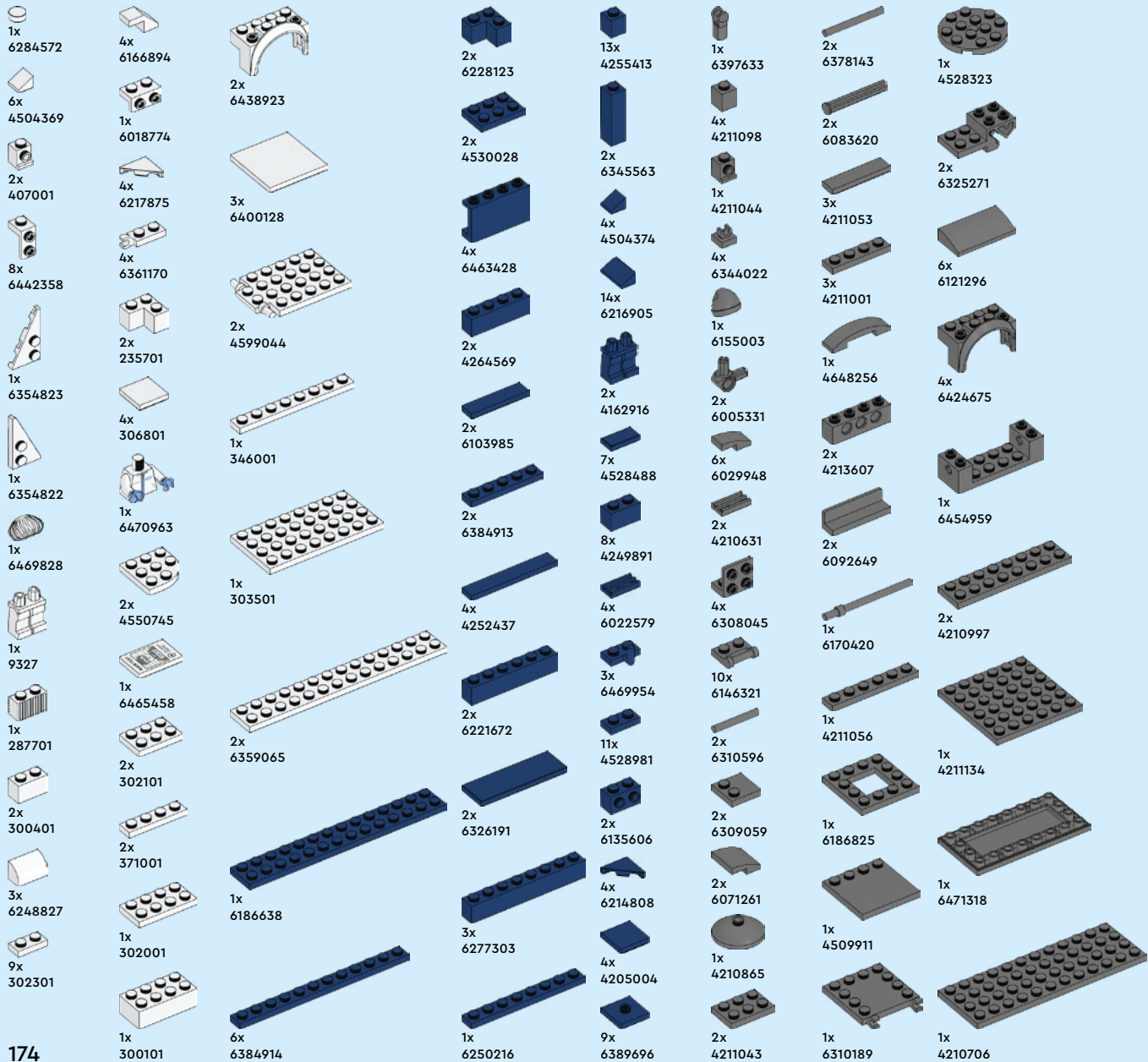
1x
6240515





1x
6450904



1x
6470966



1x
6471267



2x
6213777

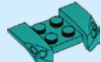

2x
6291008



1x
6329593



3x
6167690



3x
4569382



1x
6058135



1x
6347304



2x
6055309



3x
6343854



1x
6106193



1x
6004435



2x
6394948



6x
6290986



1x
4211152



1x
6073984



4x
6382324



2x
6425975



4x
6380131



4x
6380691



9x
6388037



3x
6355732



3x
4625036



8x
6240227



3x
6240212



2x
6251290



2x
6390369



1x
6238677



2x
6292200



3x
6240222



2x
6251289



2x
6252050



2x
6266252



1x
362323



3x
379523



1x
346023



2x
6284071



1x
6439041



2x
6061702



2x
4211415



1x
6329583



5x
4211389



2x
6320306



1x
4550170



2x
6420741



2x
4211475



2x
4211383



2x
6092111



2x
6186657



4x
4211388



2x
4515374



2x
6093859



4x
6313114



2x
6206249



1x
6004990



1x
6117967



2x
4641048



1x
6065824



2x
6435857



1x
4211349



2x
6102357



4x
6469440



1x
6306721



8x
6230234



1x
6118827



2x
6132207



6x
4211445



1x
4211636



1x
4211394



3x
6262961



4x
4211395



1x
6108560



3x
4211549



4x
4211393



3x
4211549



4x
4211393



2x
4243797



1x
4211452



1x
4211795



1x
4211474



2x
4211425



1x
4251149



1x
4211522

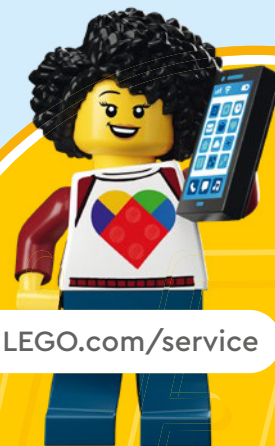

[LEGO.com/service](https://www.LEGO.com/service)

YOU COULD **WIN**



Scan this QR code or go to **LEGO.COM/PRODUCTFEEDBACK** and give us your short feedback about this LEGO® set for a chance to win a cool LEGO prize.

Terms and Conditions apply*

EN: YOU COULD WIN. Terms and Conditions apply* **DE: Du könntest GEWINNEN.** Es gelten die Teilnahmebedingungen* **FR: Tu pourrais GAGNER.** Des conditions s'appliquent* **IT: Potresti VINCERE tu.** Termini e condizioni sono applicabili* **ES: Puedes GANAR.** Aplican términos y condiciones* **PT: Poderá GANHAR.** Aplicam-se termos e condições* **ZH: 轻松获奖. 条款和条件适用*** **PL: Szansa na WYGRANĄ.** Obowiązują warunki korzystania* **CS: Máte šanci VYHRÁT.** Platí všeobecné smluvní podmínky* **SK: Máte šancu VYHRAŤ.** Platia všeobecné zmluvné podmienky* **HU: TE IS NYERHETSZ.** Felhasználási feltételek érvényesek* **RO: Ai putea CÂȘTIGA.** Se aplică termeni și condiții* **BG: Можете да СПЕЧЕЛИТЕ.** Има определени правила и условия* **LV: Tu vari LAIMĒT.** Ir spēkā noteikumi un nosacījumi.* **ET: Sul on võimalus VÕITA.** Kehtivad tingimused* **LT: Jūs galite LAIMĖTI.** Taikomos sąlygos*

*[LEGO.com/productfeedback-terms](https://www.lego.com/productfeedback-terms)