

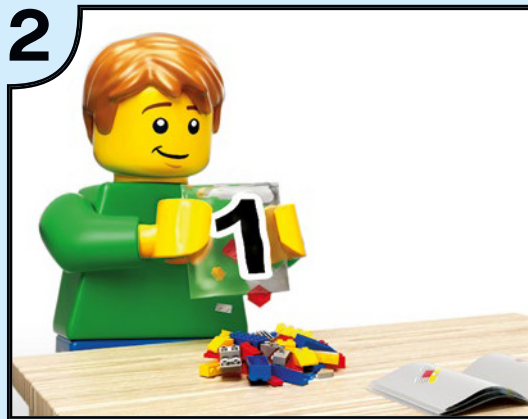

CITY

60270







- 1 Scan the code on the front cover
Scanne den Code auf der Titelseite
Scanne le code sur la page couverture
Scanner le code sur la page couverture
Scansiona il codice sulla copertina
Escanea el código de la portada
Faz scan do código na frente da capa
Olvasd be a borítón látható kódot!
Noskenë kodu uz priekšējā vāka
扫描封面上的二维码



- 2 Get the Building Instructions
Hol dir die Bauanleitung
Obtiens les instructions de montage
Obtenir les instructions de montage
Scarica le istruzioni per la costruzione
Consulta las instrucciones de construcción
Obtém as Instruções de Construção
Szerezd be az építési útmutatókat!
Saņem būvēšanas instrukcijas
获取拼搭说明

LEGO.com/apps

Check for compatibility
Kompatibilität prüfen
Vérifier la compatibilité
Controlla la compatibilità
Comprueba tu compatibilidad

Verificar a compatibilidade
Ellenőrizd a kompatibilitást
Pārbaudīt saderību
检查兼容性

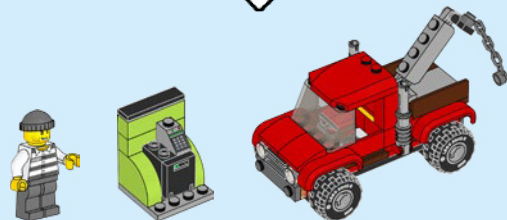
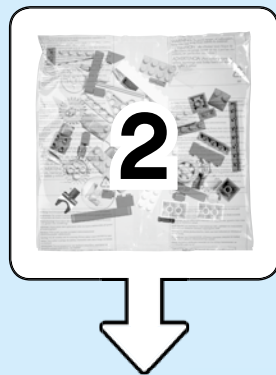

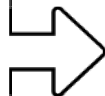
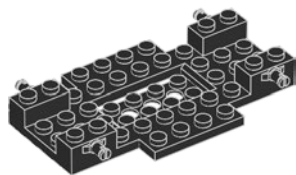

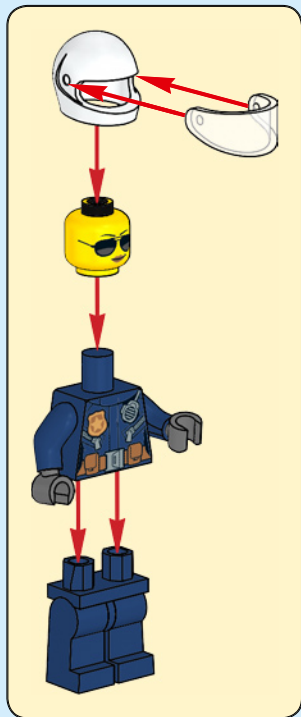

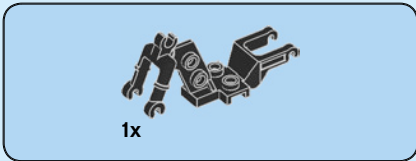

1

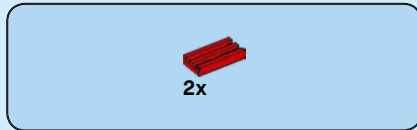
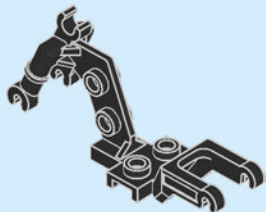

2

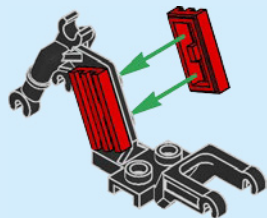



1x

3



8



4



5

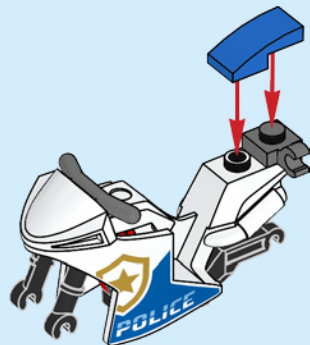



2x



2x

6

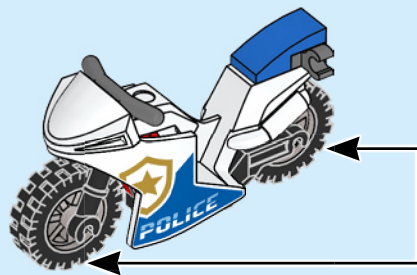

2x



1x



1x

7

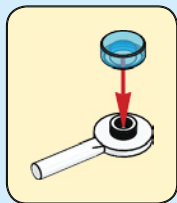

8



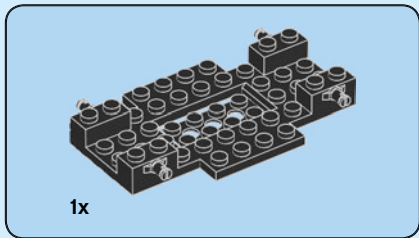
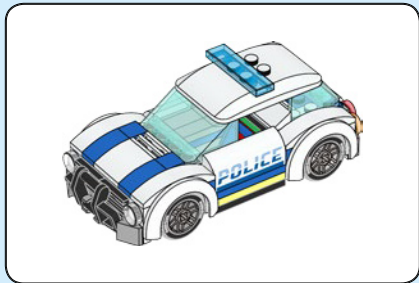

1

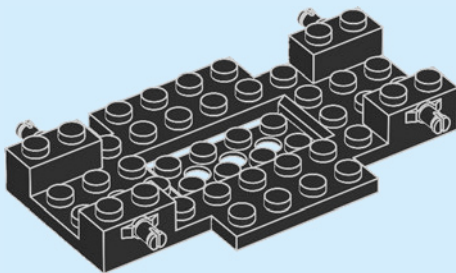

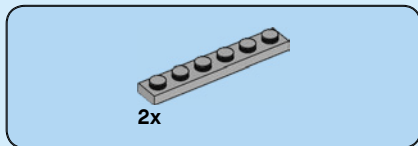

2

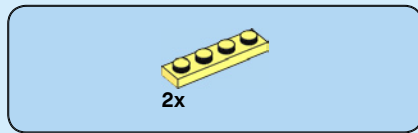
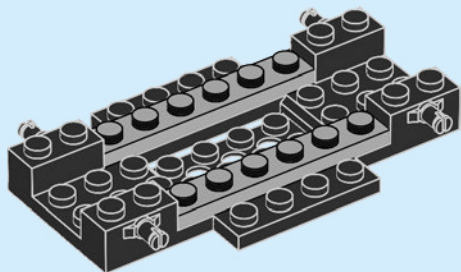

3

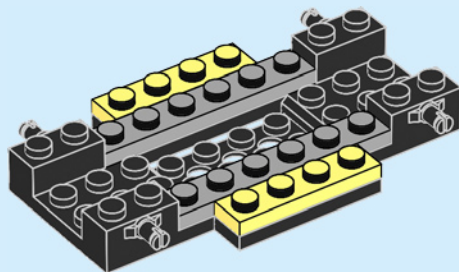



2x

4

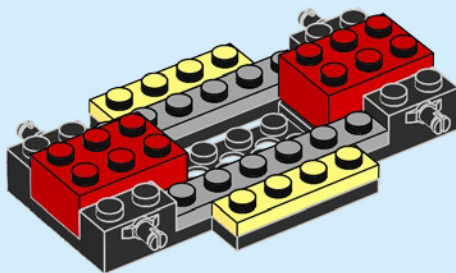



1x



1x

5

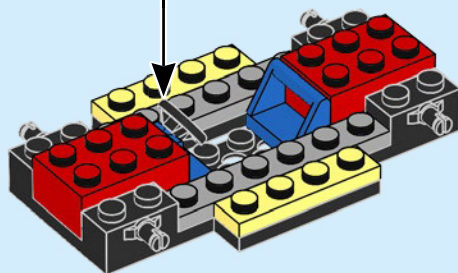
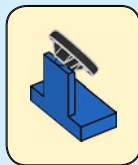

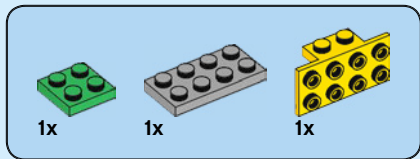

6

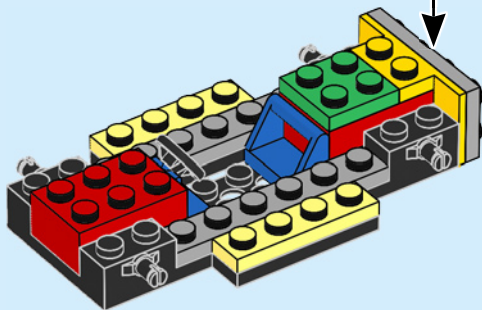
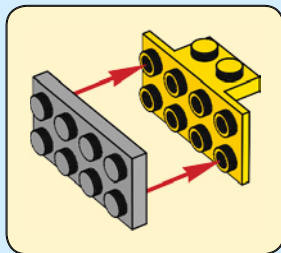

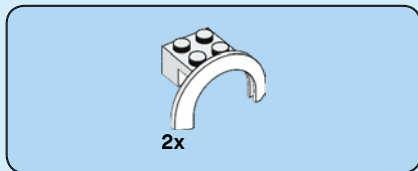

7

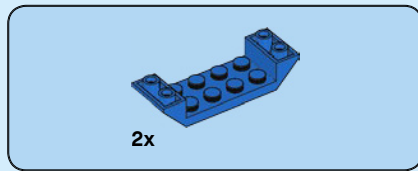
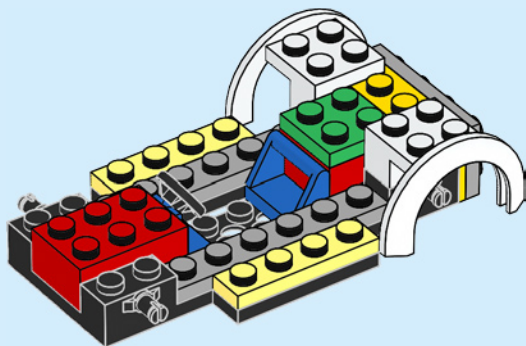

8

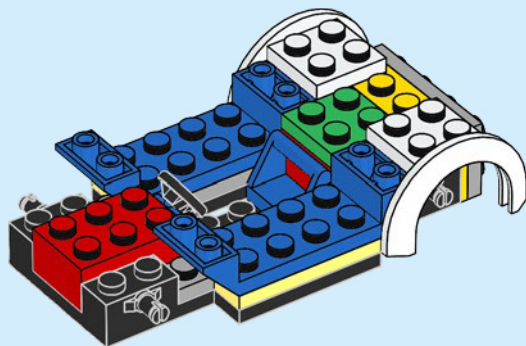

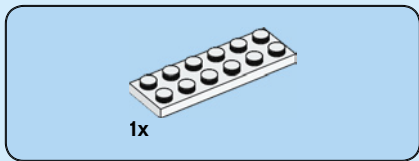
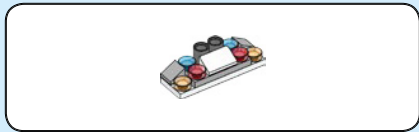

9

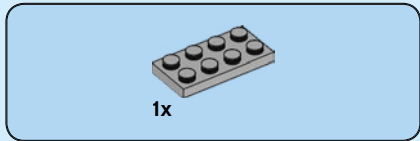

10

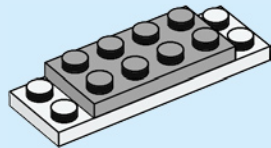



11

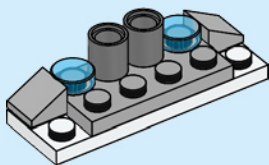

12

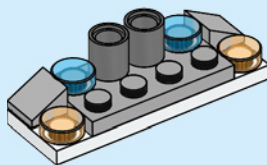

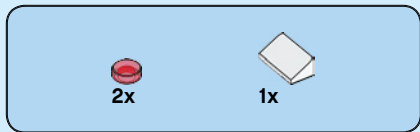

13

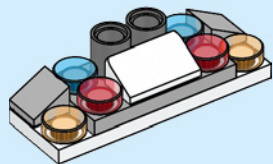

14

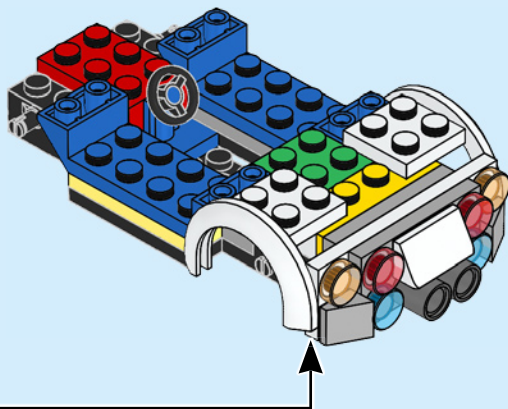



1x



1x

15

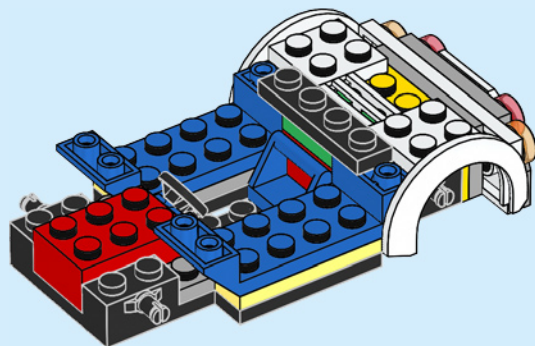



2x

16



2x

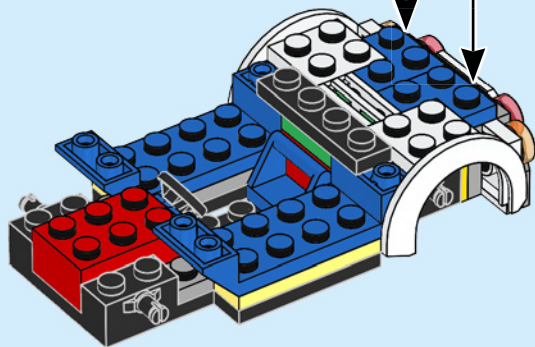



2x

17

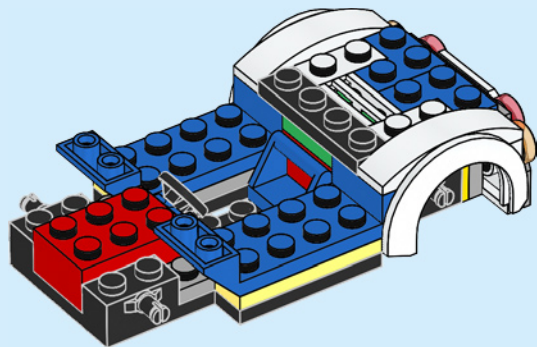

2x

18

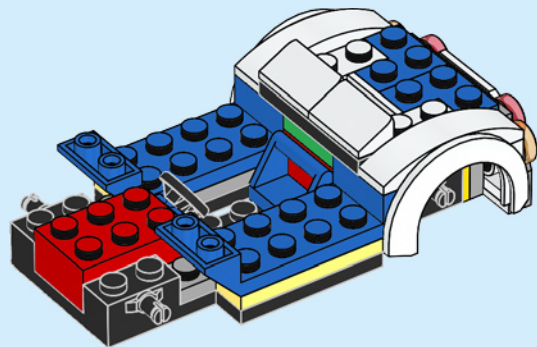

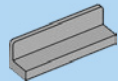

2x

19

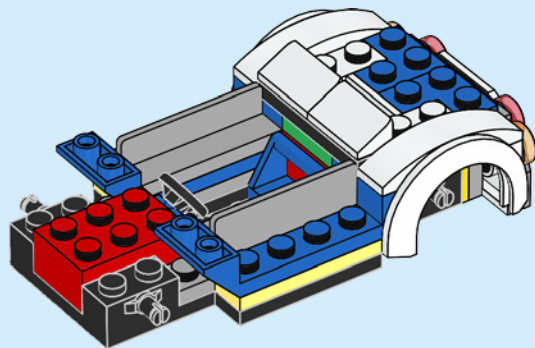



2x

20

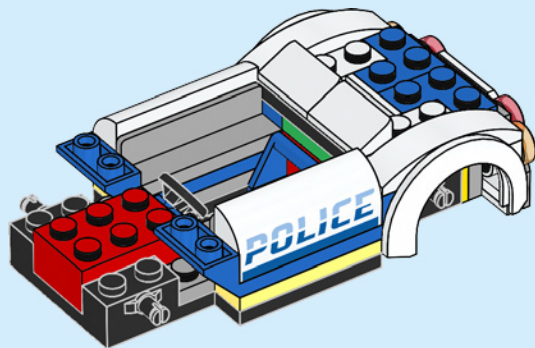

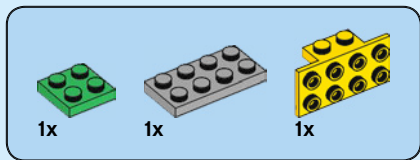

21

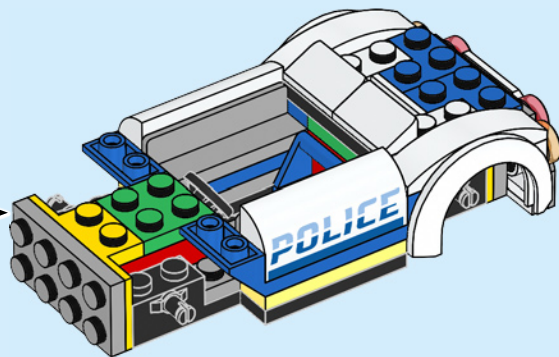
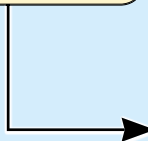
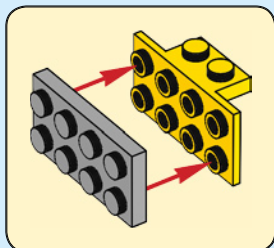

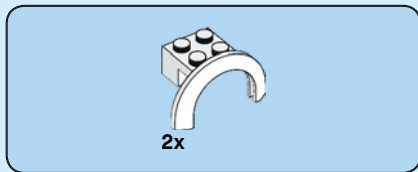

22

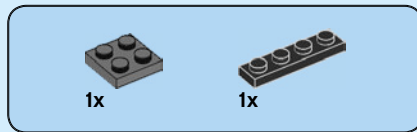
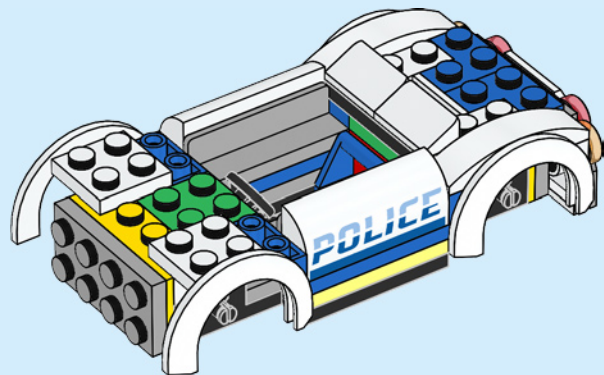

23

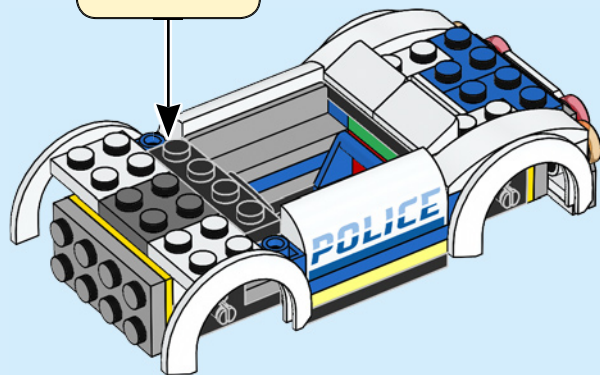
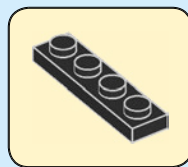



1x

24

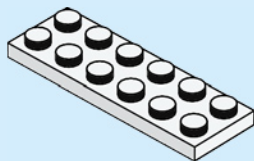

2x



2x

25

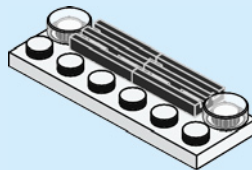



2x



2x

26

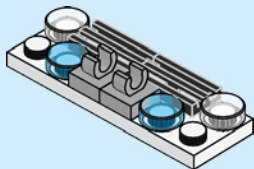

2x

27

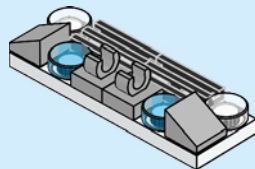



1x

28

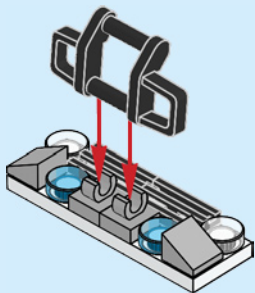

29

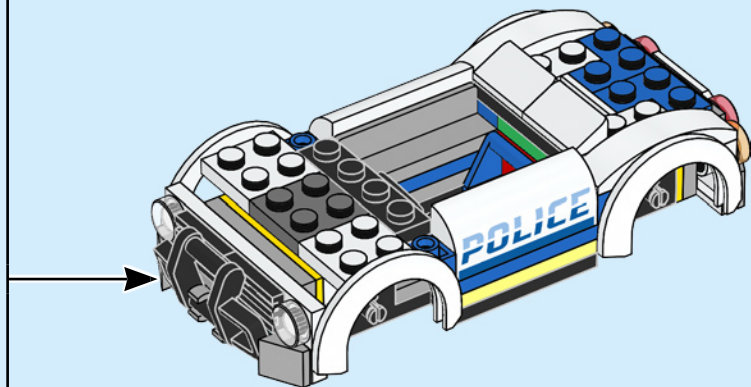



2x

30

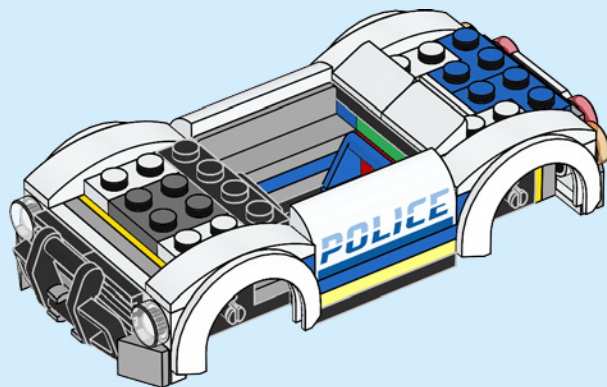



1x



2x

31



2x

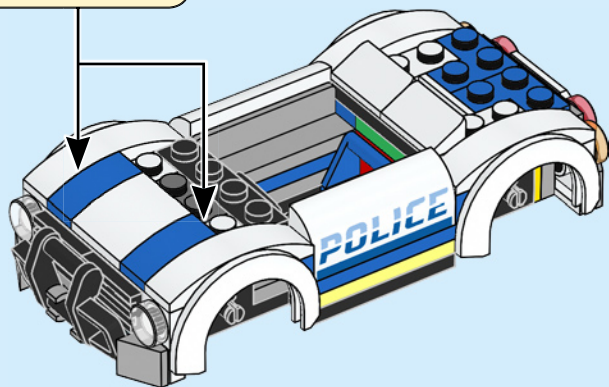

32



1x



2x

32

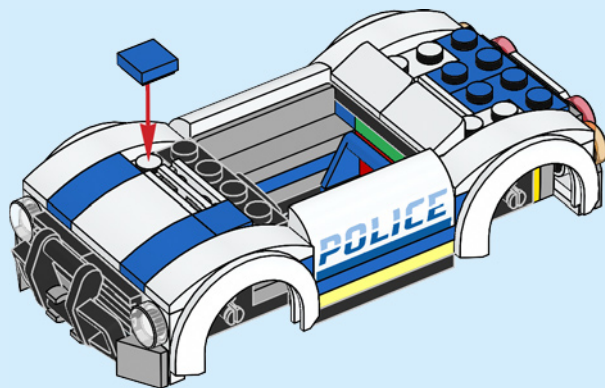

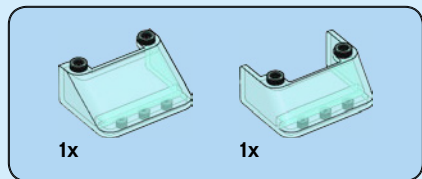

33

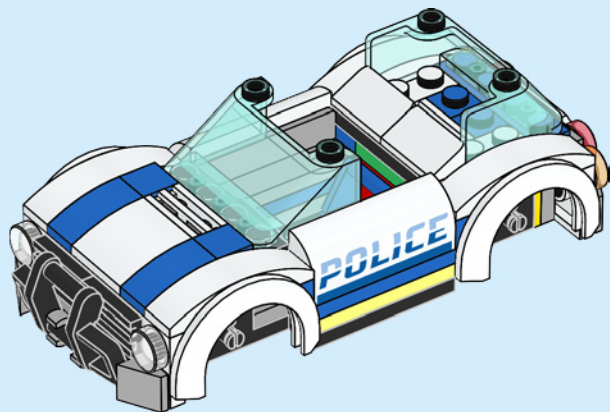

34

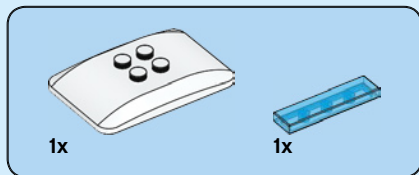

34

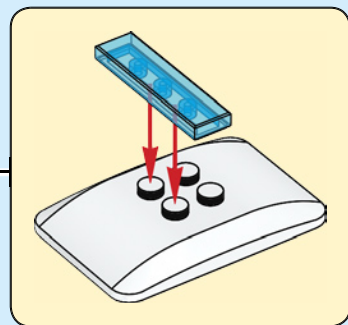
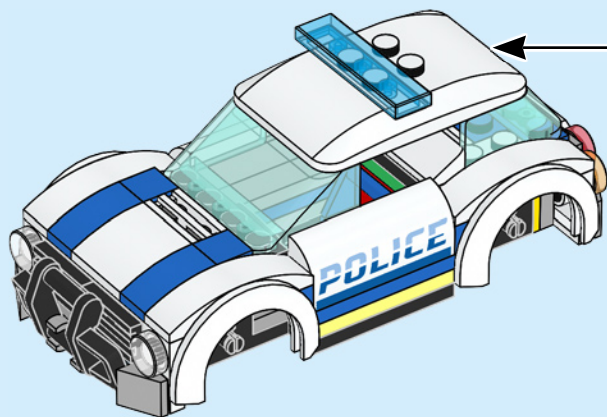



35

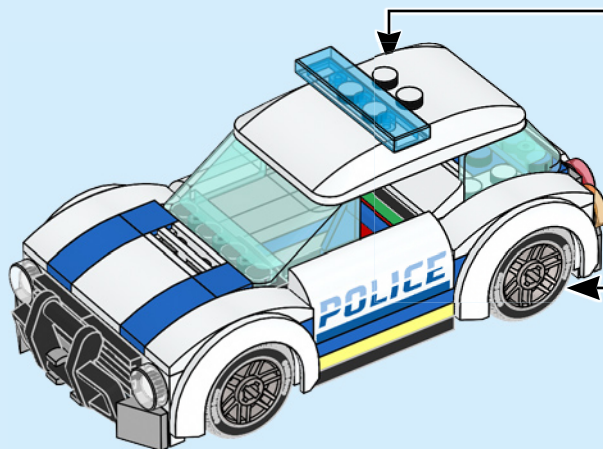
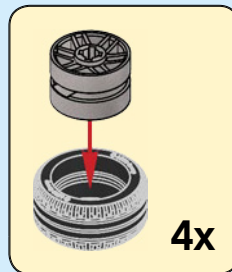

36

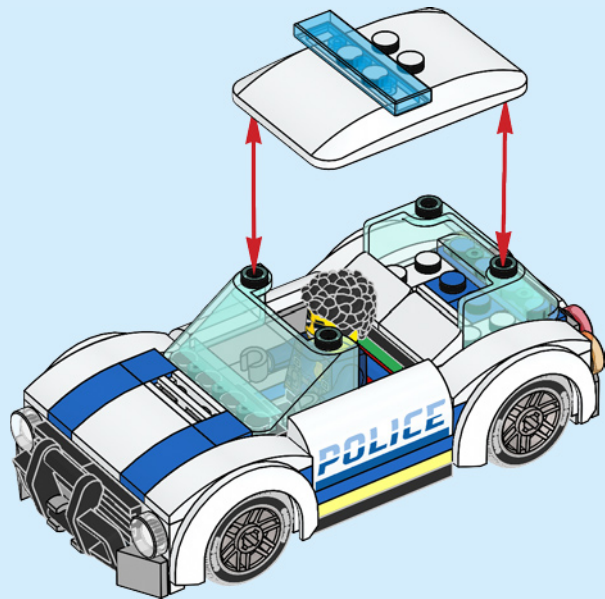

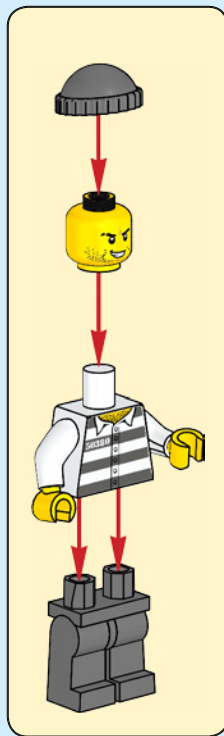
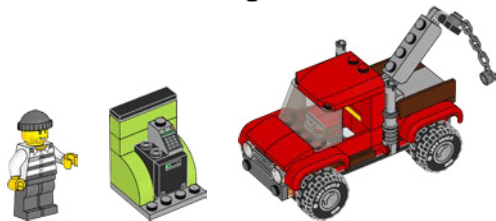
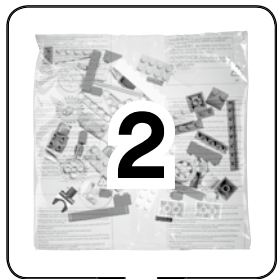

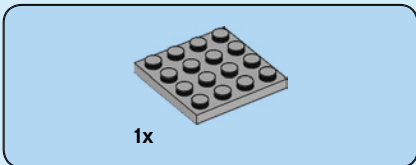
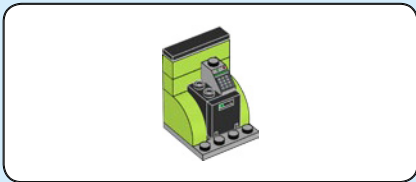

1

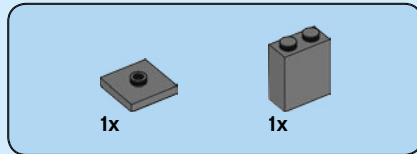
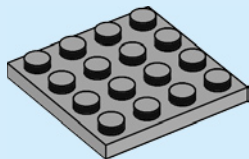

2

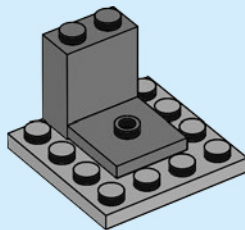



2x

3

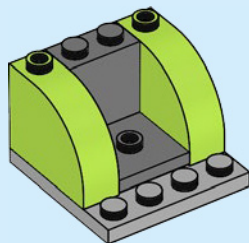

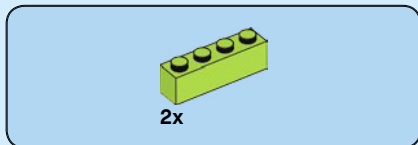

4

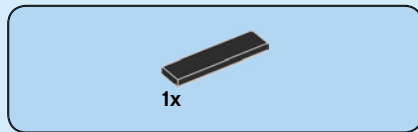
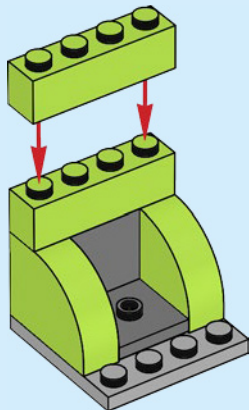

5

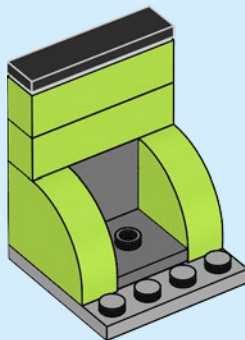

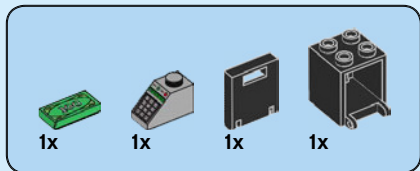

6

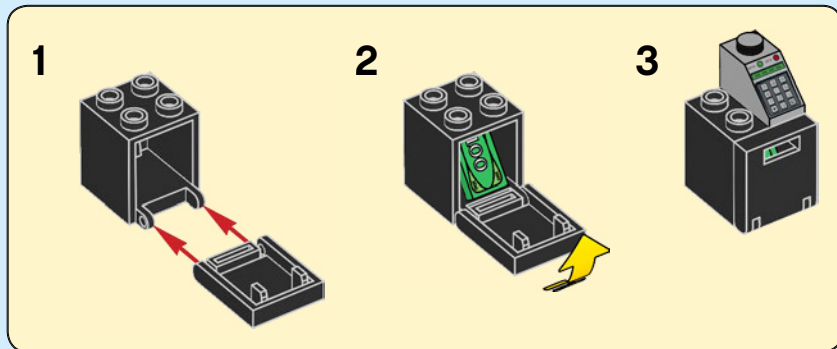

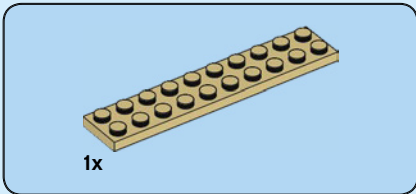
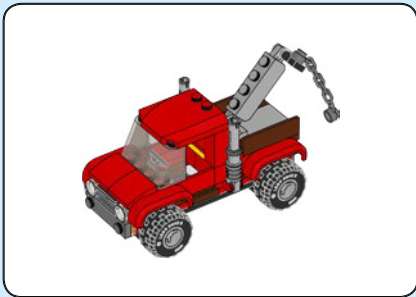

1x

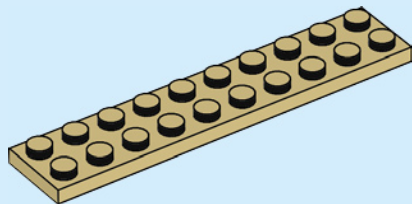

1



2x

2

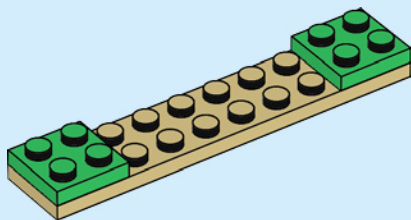

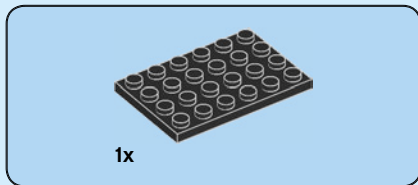

3

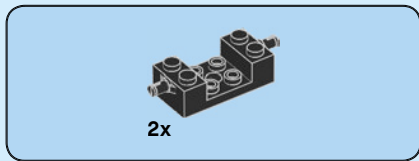
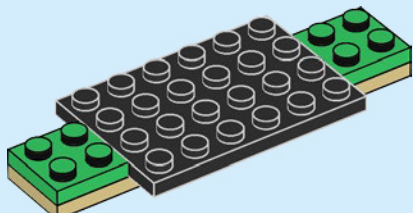

4

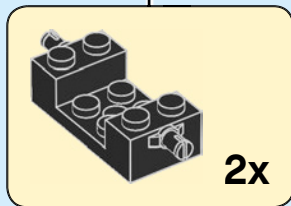
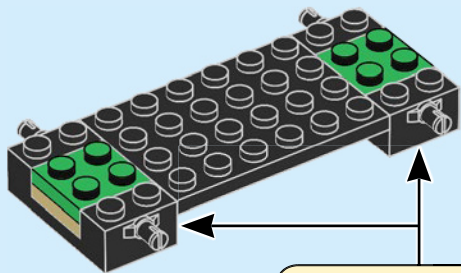

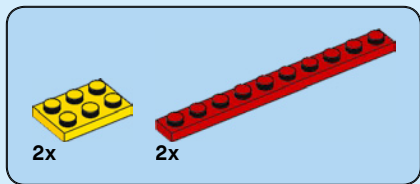

5

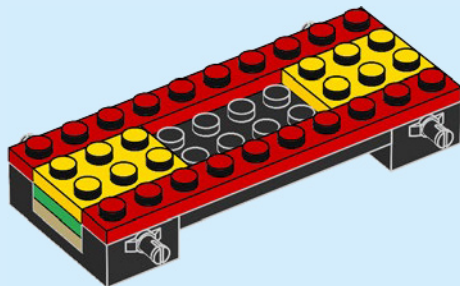

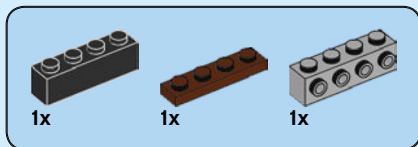

6

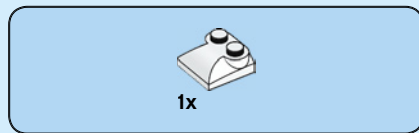
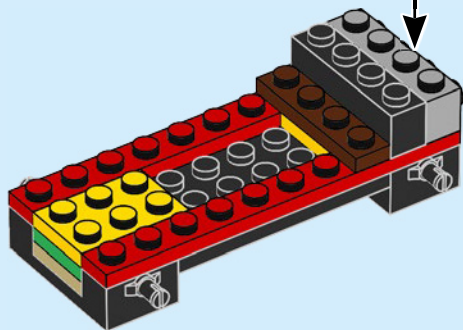
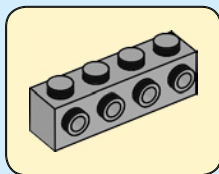

7

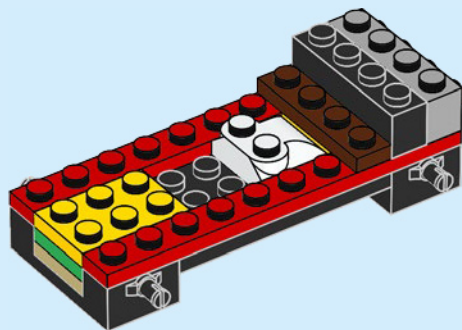



2x



2x

8

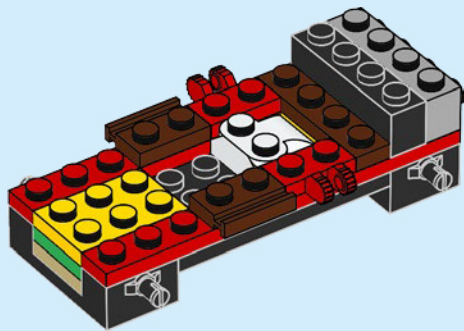



1x

9

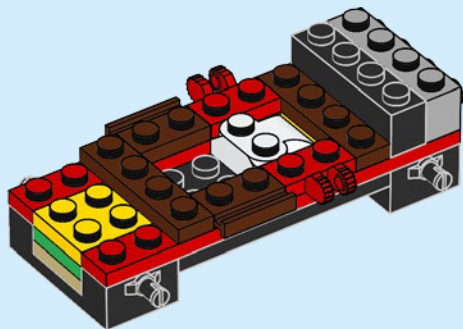

2x



1x

10

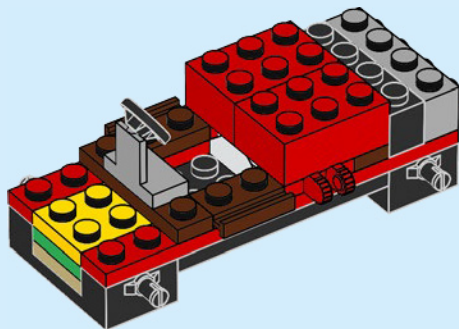



2x

11

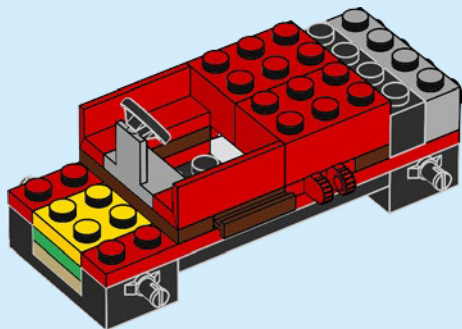

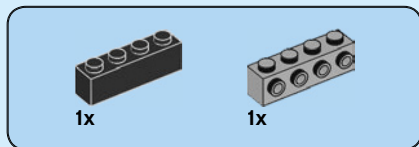

12

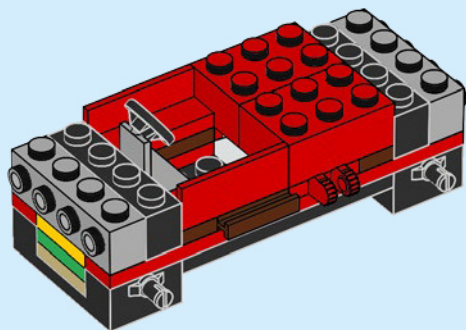

13

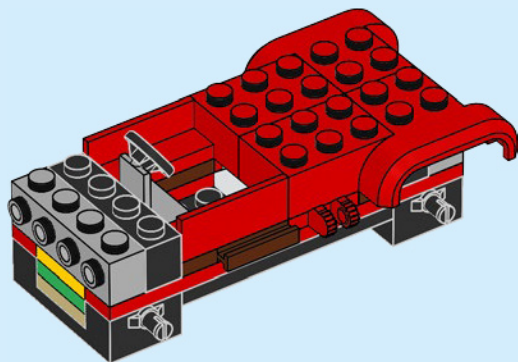

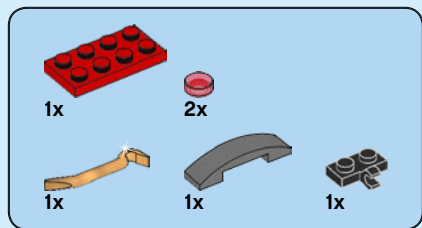

14

1

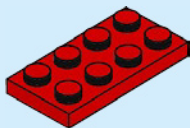

2

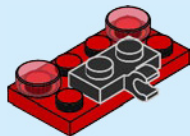

3

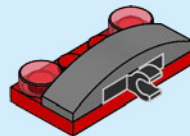

4

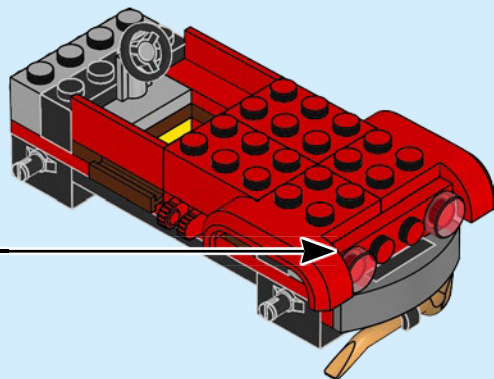
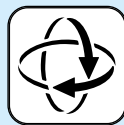
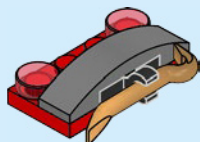

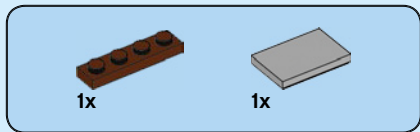

15

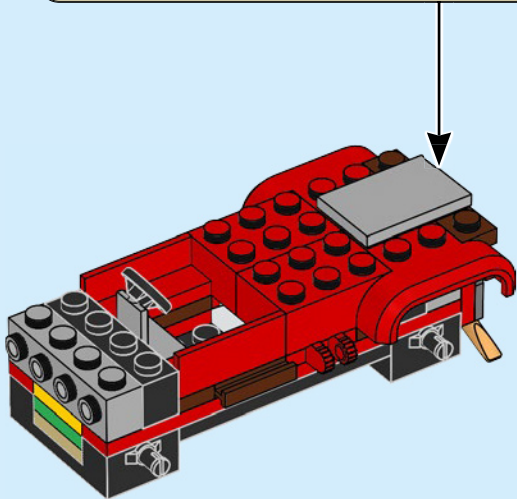
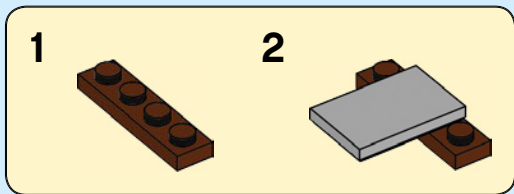



2x

16

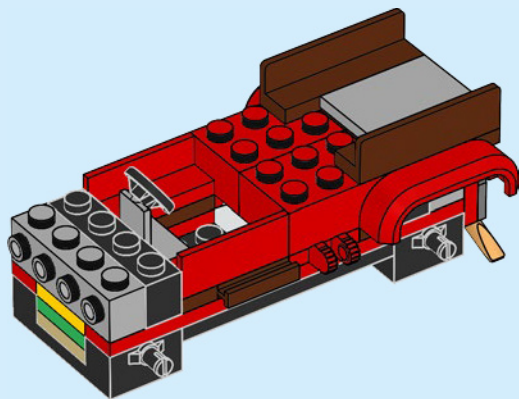

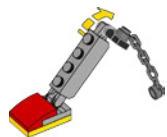

1x

17



1x

18

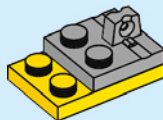



1x

19

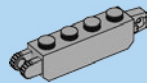
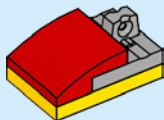

1x

20

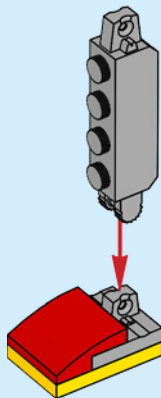



1x

21

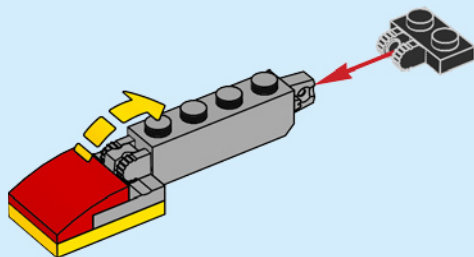

1x

22

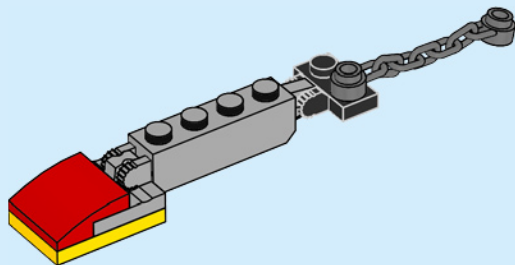

23

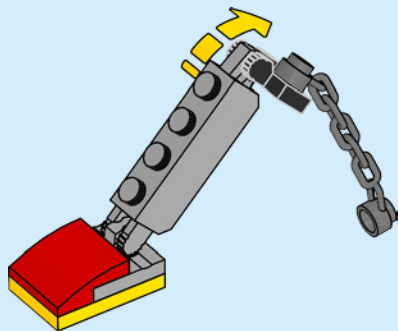

24

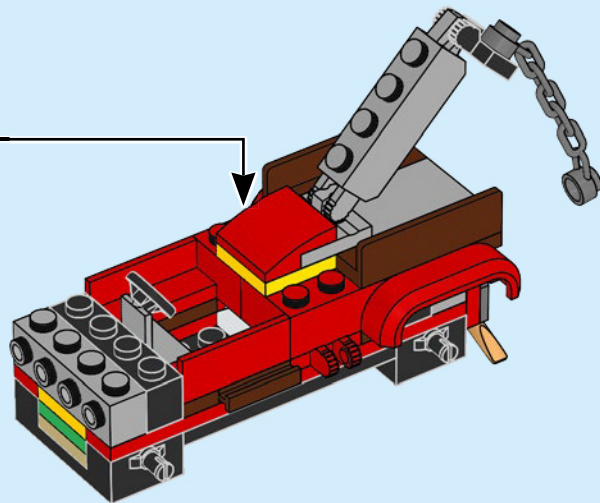



2x

25

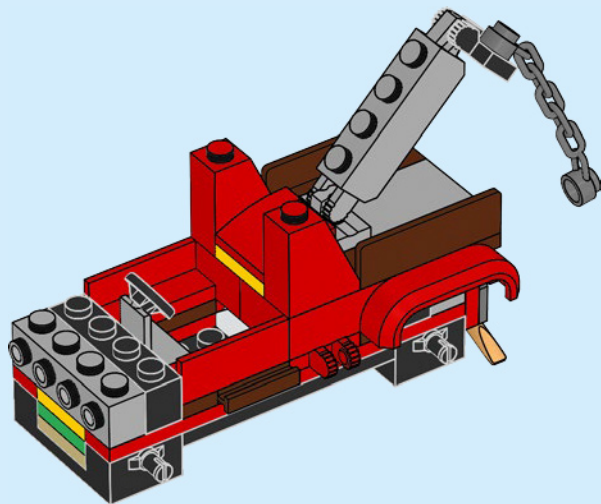



2x

26

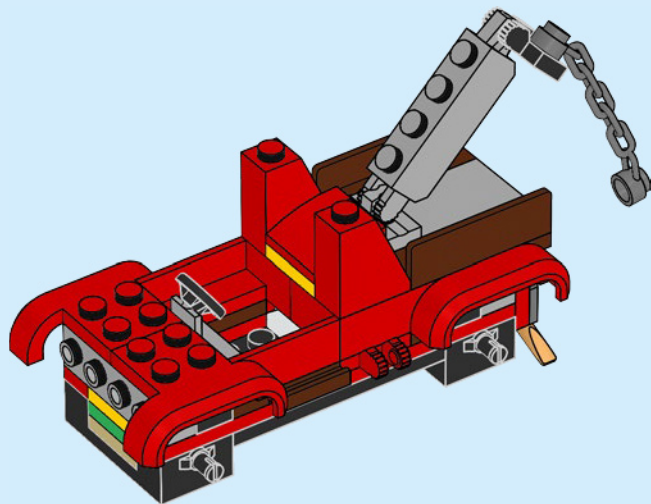

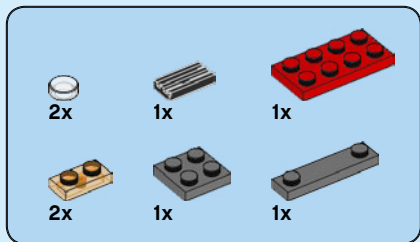

27

1

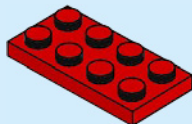

2

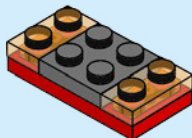

3

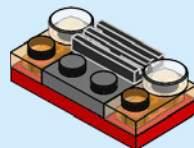

4

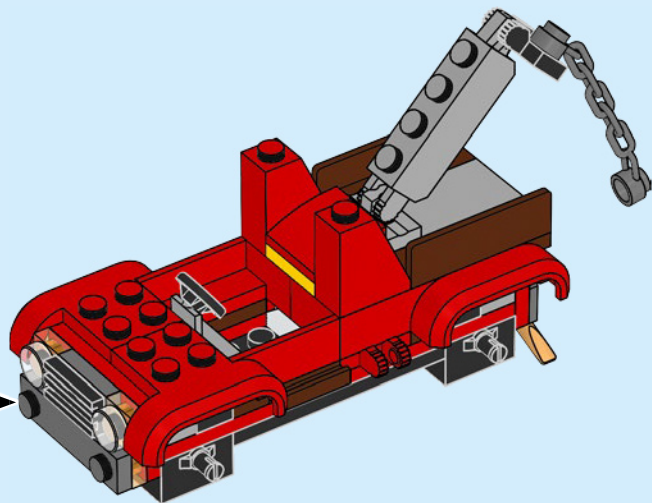
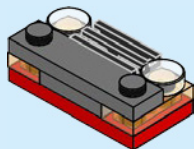



2x

28

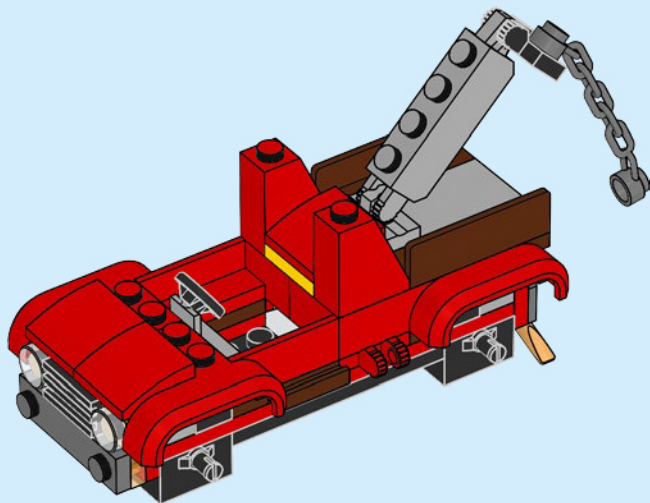

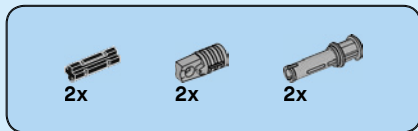

29

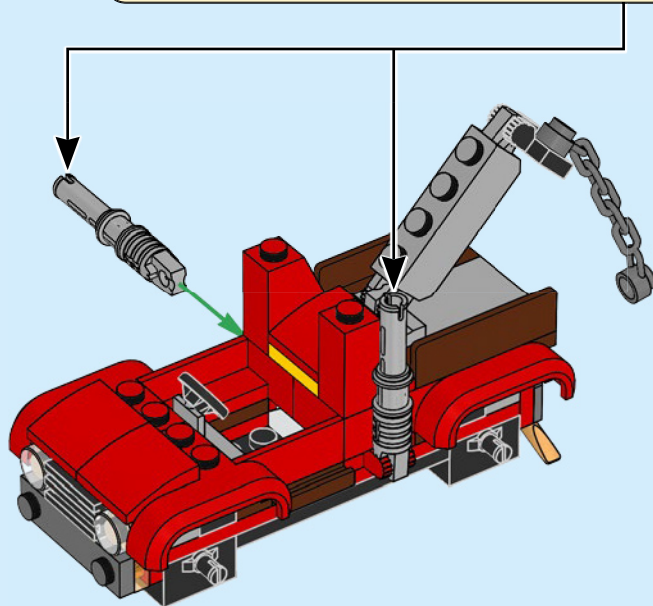
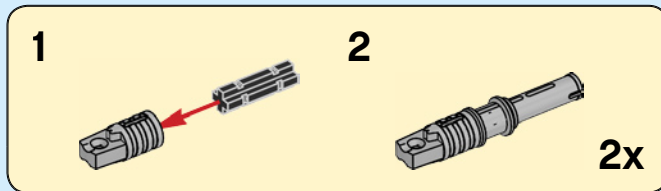



1x

30

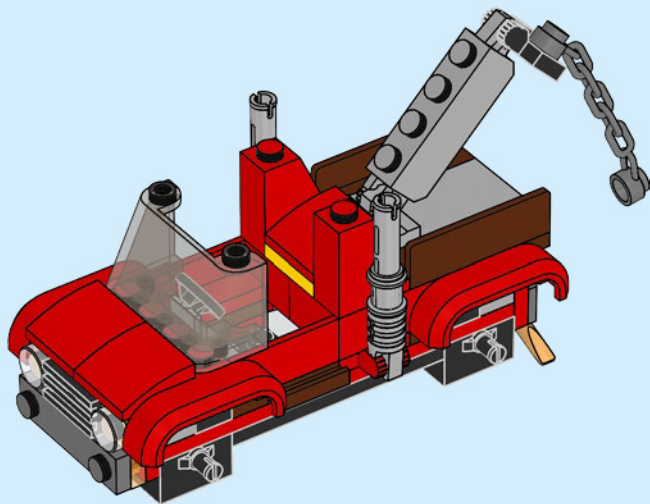

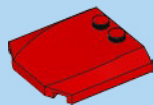

1x

31

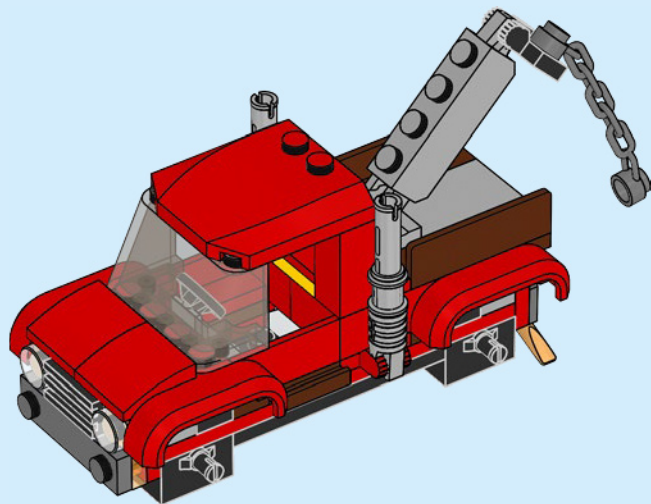

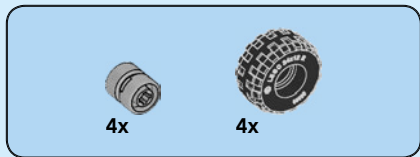

32

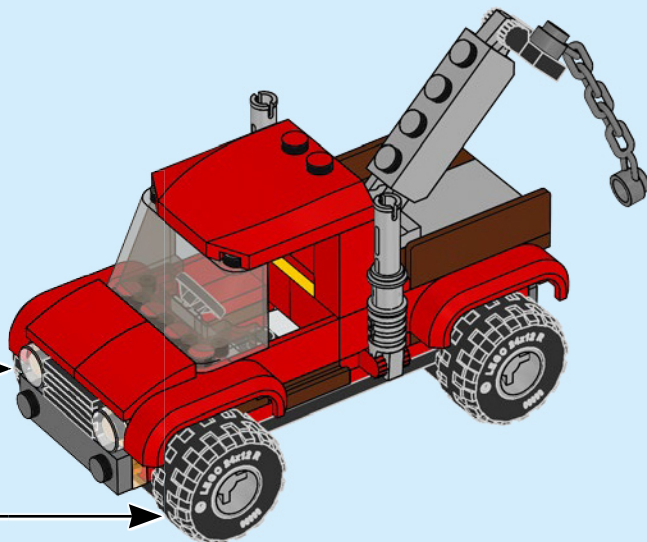
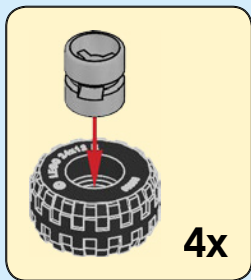

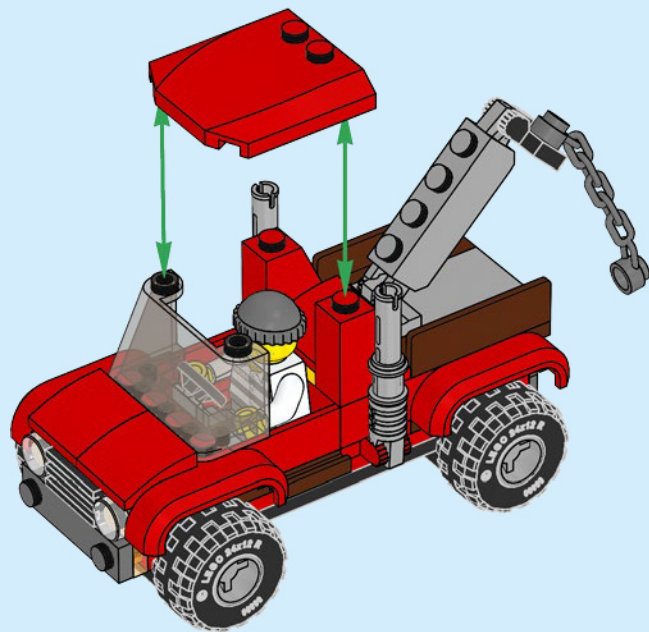



ManagerExcellentCrocodile

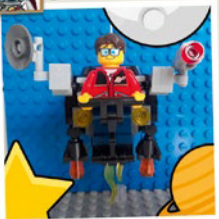

KingYummyChee'ah



PrincessBossyRooster

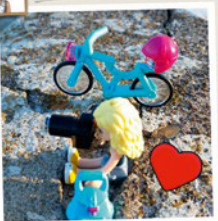

LEGO.com/apps





CITY



WIN

GO TO WWW.LEGO.COM/PRODUCTFEEDBACK AND
GIVE US YOUR SHORT **FEEDBACK** ABOUT THIS
LEGO® SET FOR A CHANCE TO WIN
A COOL LEGO PRIZE.

Terms & Conditions apply



LEGO.com/productfeedback

GEWINNE

Erzähle uns auf
www.LEGO.com/productfeedback

etwas über die Erfahrungen, die du mit
diesem LEGO® Set gemacht hast, und
sichere dir die Chance auf einen coolen
LEGO Preis!

Es gelten die Teilnahmebedingungen

GAGNE

Rends-toi sur
www.LEGO.com/productfeedback

et donne-nous quelques commentaires sur
ce produit LEGO® pour avoir une chance
de gagner un prix LEGO !

Voir Conditions Générales

GANAN

Visita
www.LEGO.com/productfeedback

y envíanos tu opinión acerca de este set
LEGO®. ¡Participarás en el sorteo de un
premio LEGO!

Términos y Condiciones aplicables

获取奖品

登录
www.LEGO.com/productfeedback

给出关于此乐高®套装的简短反馈，
就有机会获得炫酷乐高奖品

《条款及条件》适用