

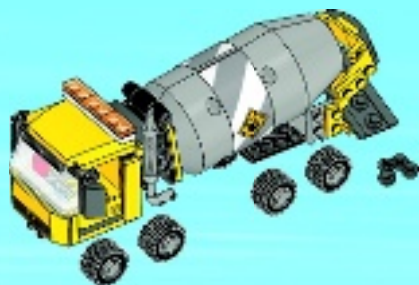

# CITY

60018

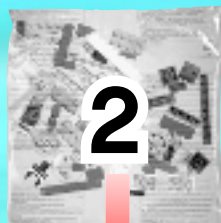



1

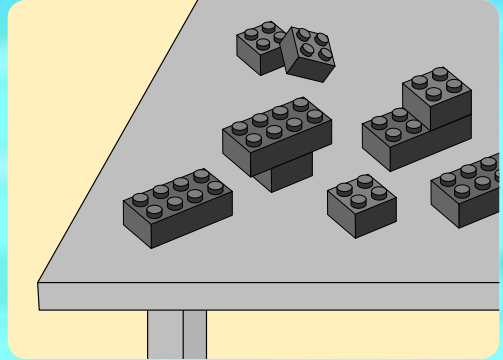
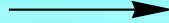
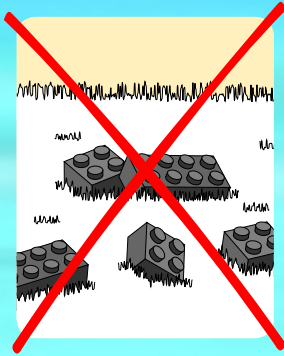

2

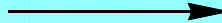

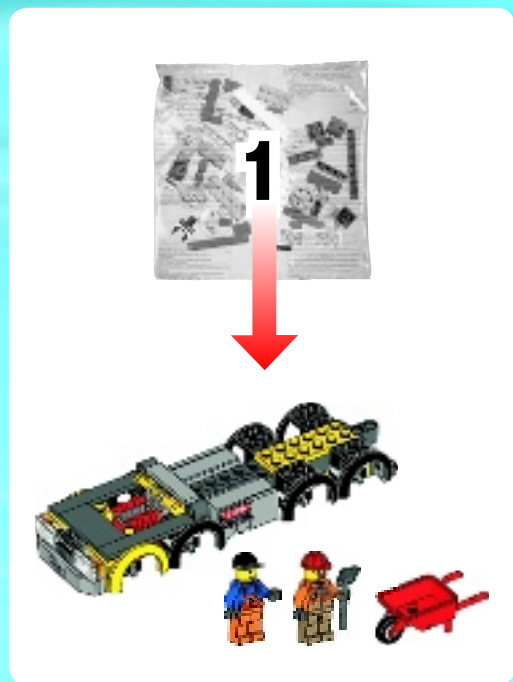

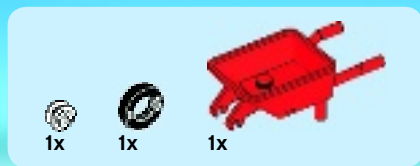

1

1



2



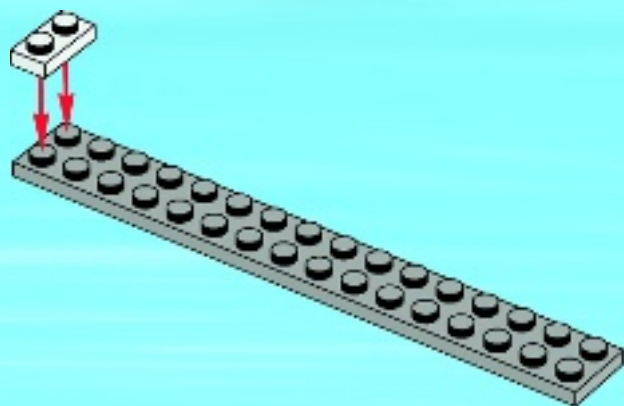
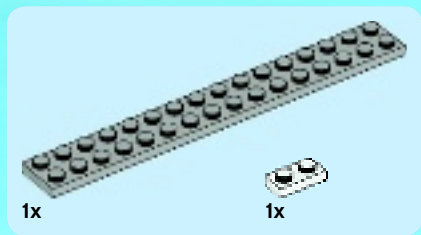

1



2x



2x

# 2

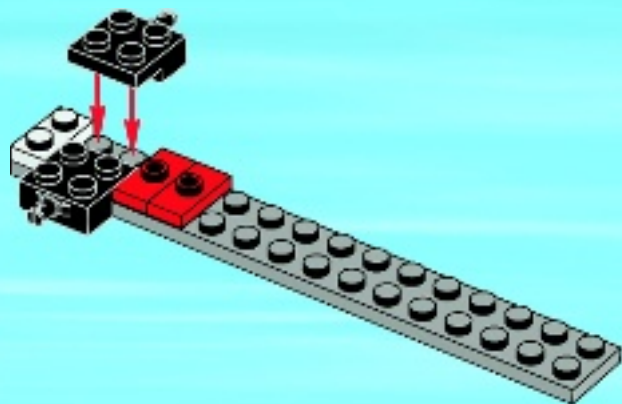

1x



2x

# 3

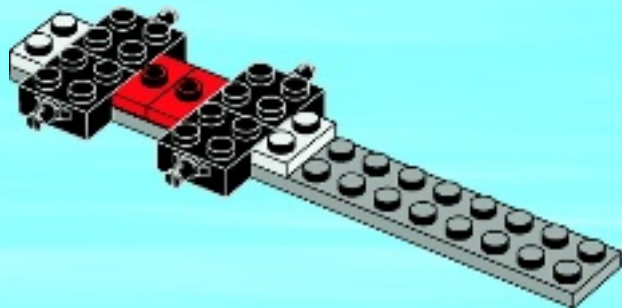



1x



4x

4

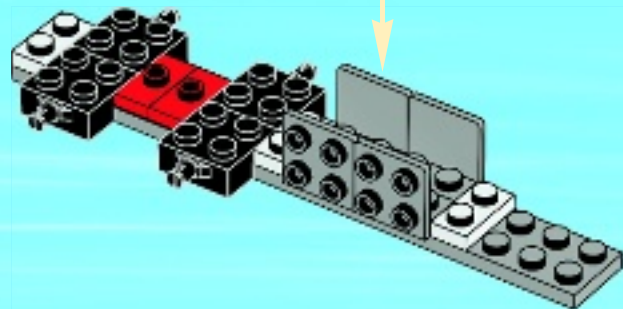
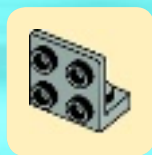





2x



1x

5

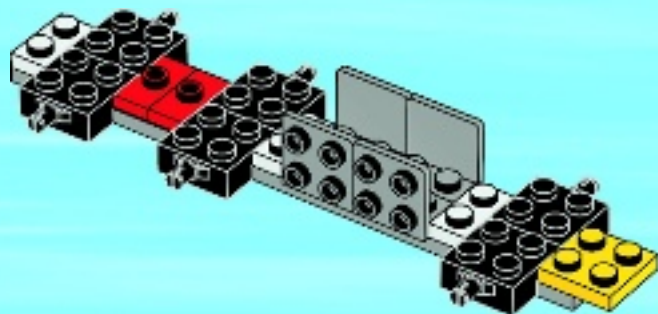



1x

6

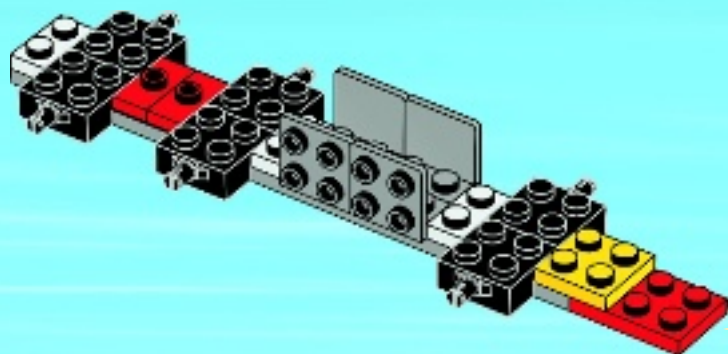



2x

7

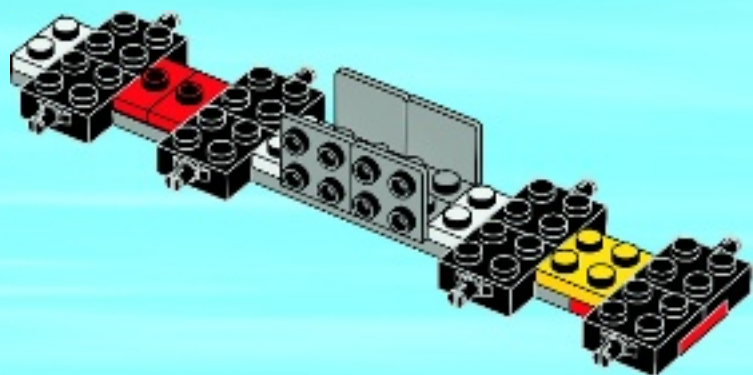



2x

8

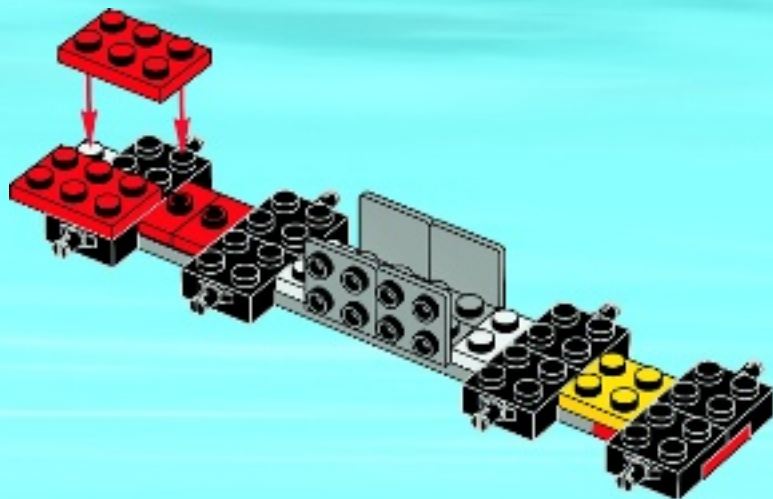



1x



1x

9

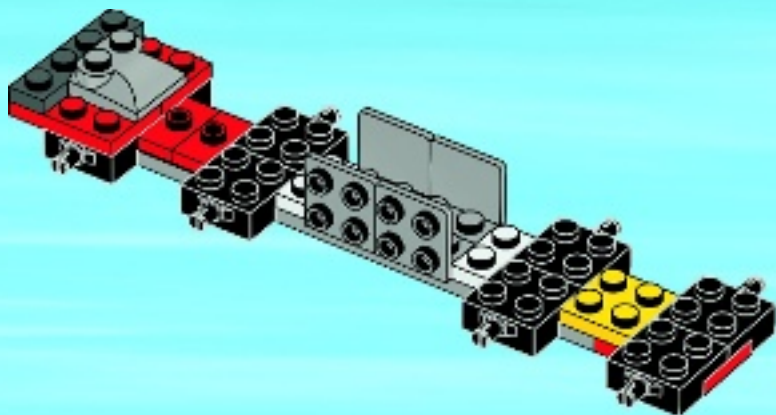



2x



1x



1x

# 10

1

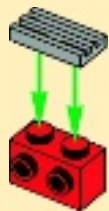

2

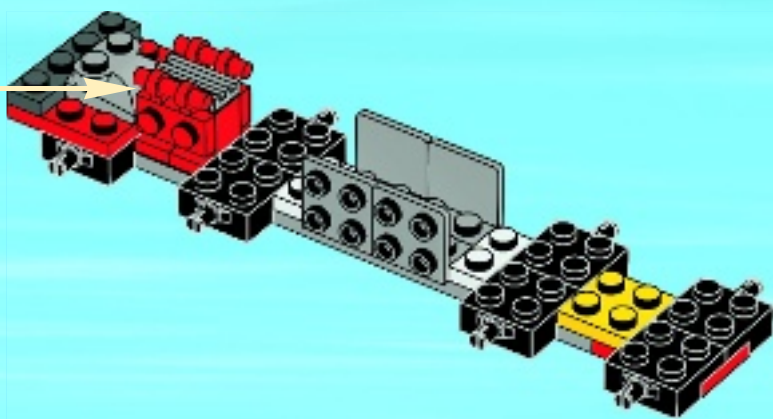
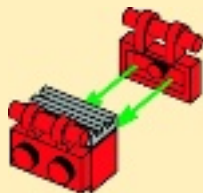



6x

11

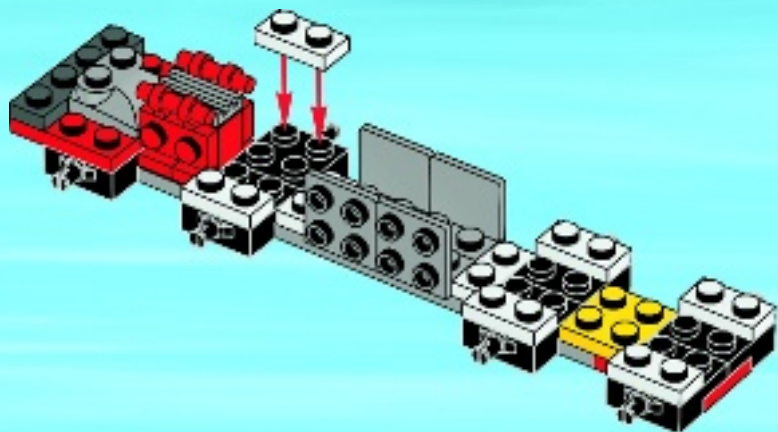



1x



1x

# 12

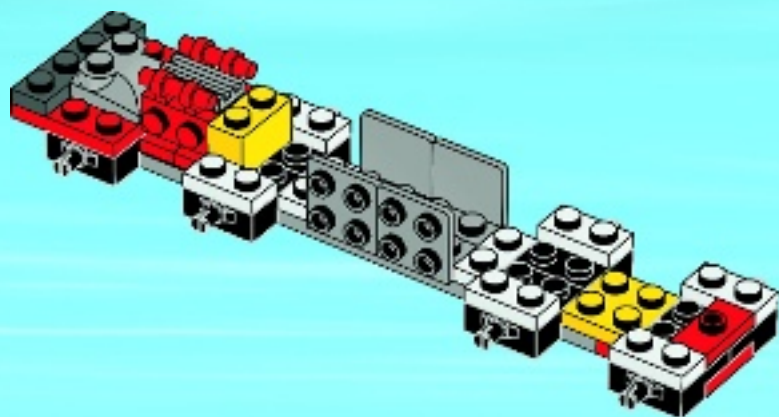



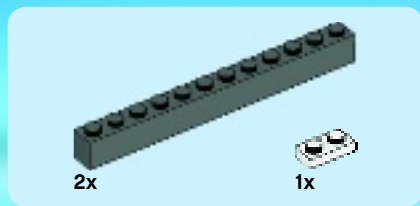

13

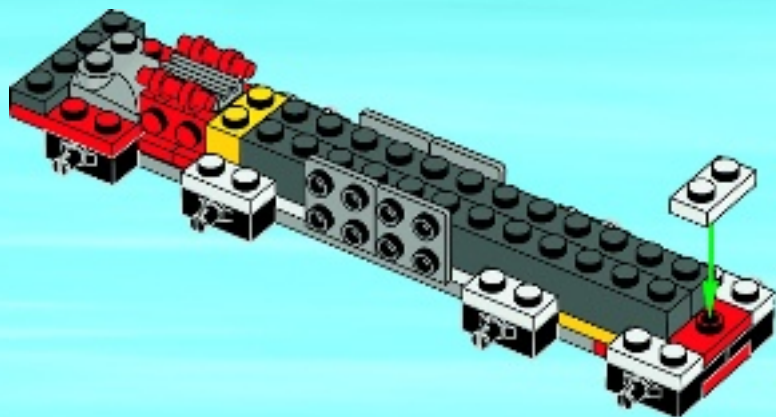



1x

14

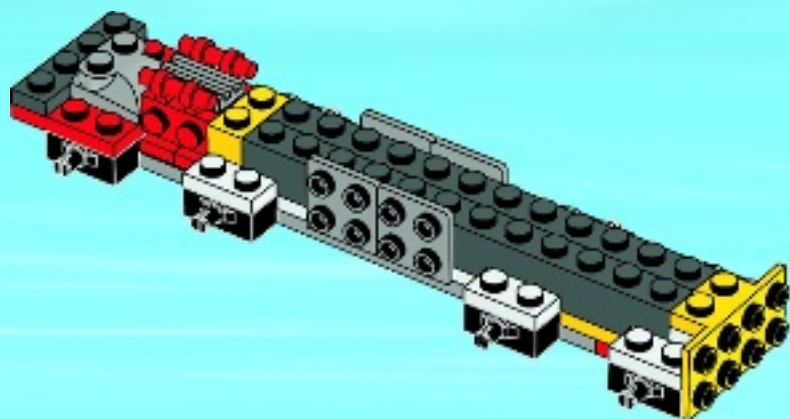



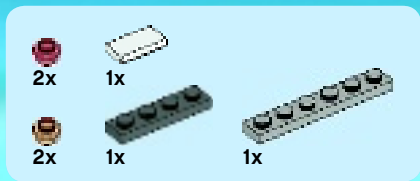

# 16

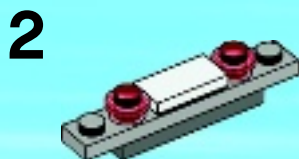
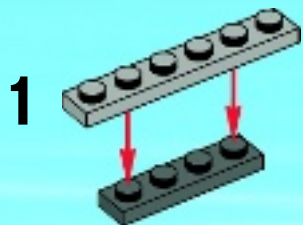

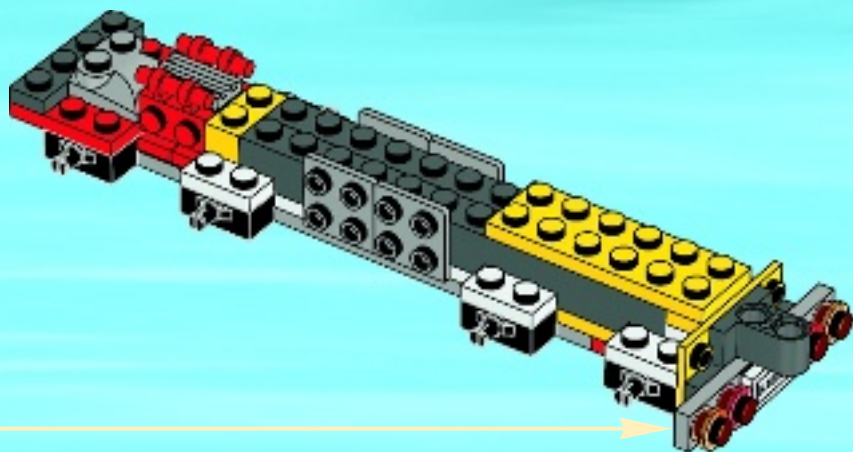

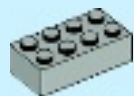

1x



1x



1x



2x

# 17

1

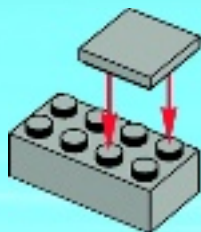

2

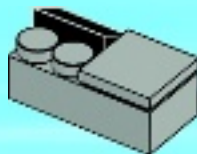

3



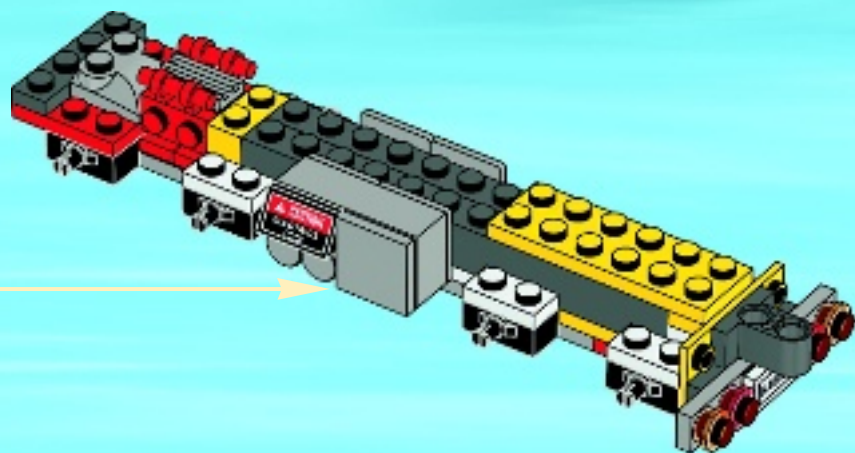

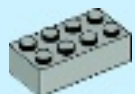

1x



1x

# 18

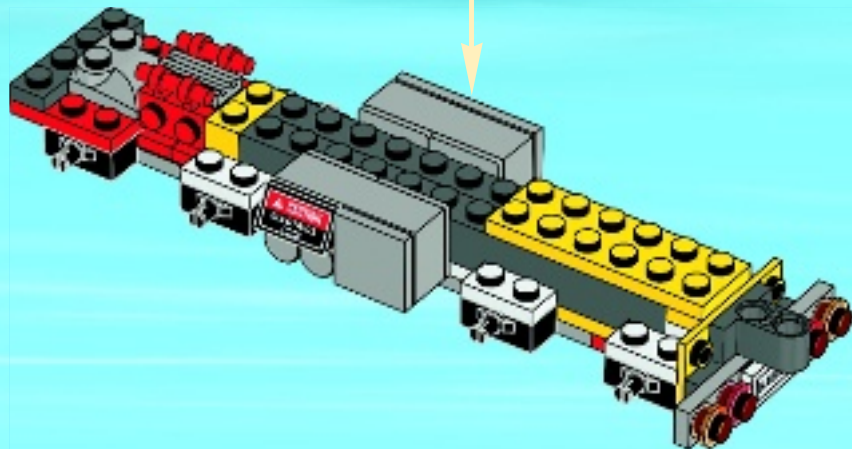
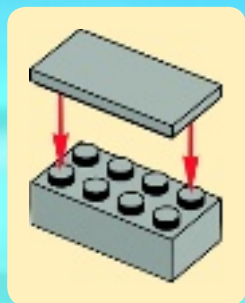





6x

19

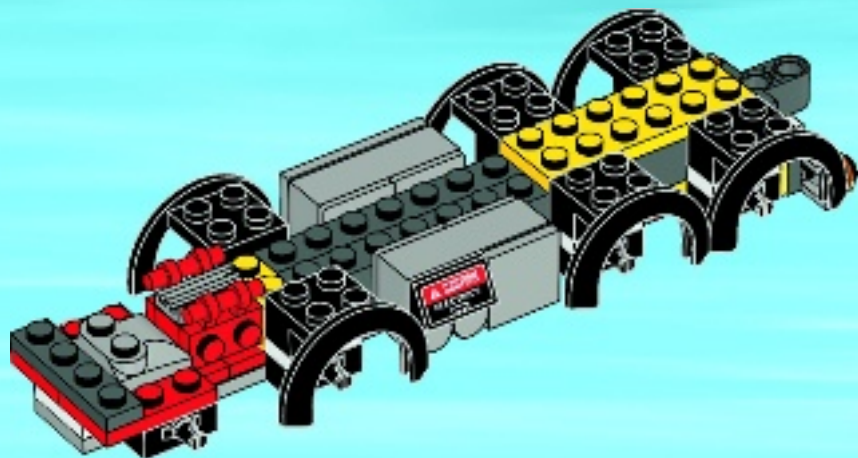



1x



2x

20

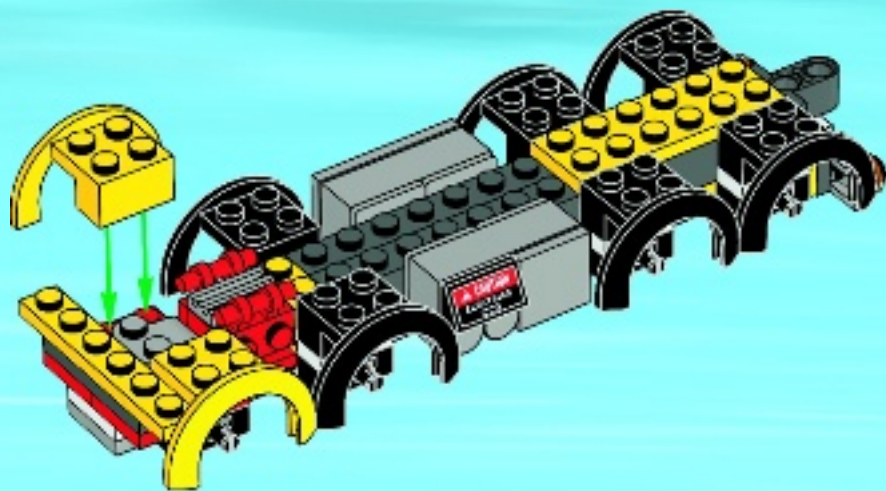



2x

21

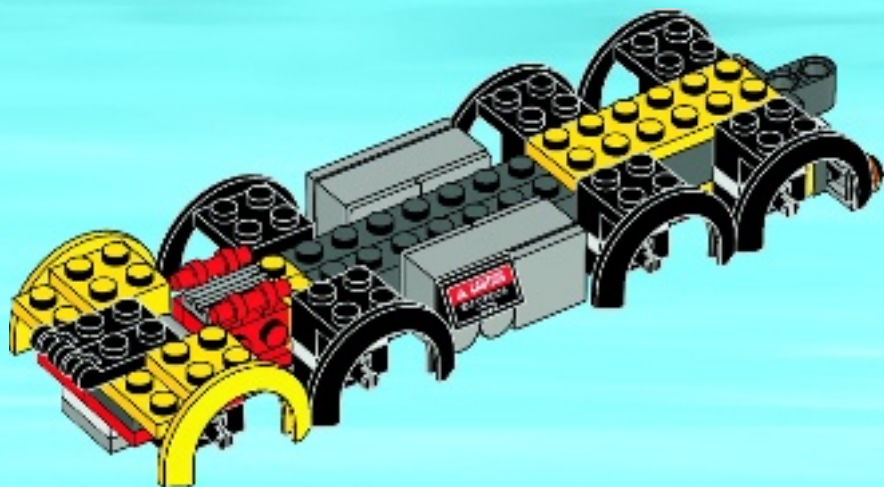



2x

22

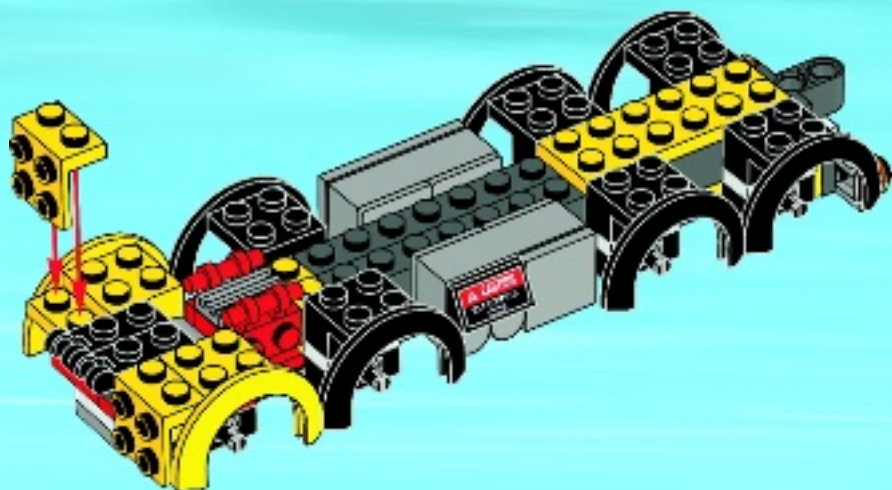





2x

24

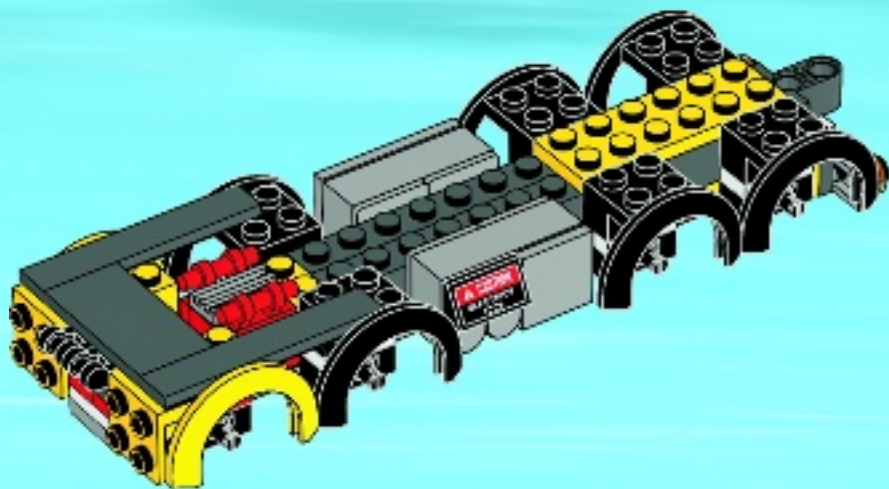





2x



1x



1x



2x

# 26

1



2

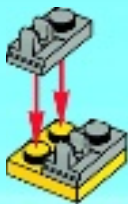

3

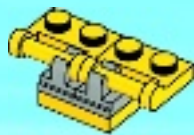

4

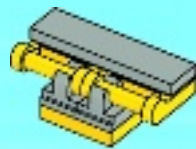



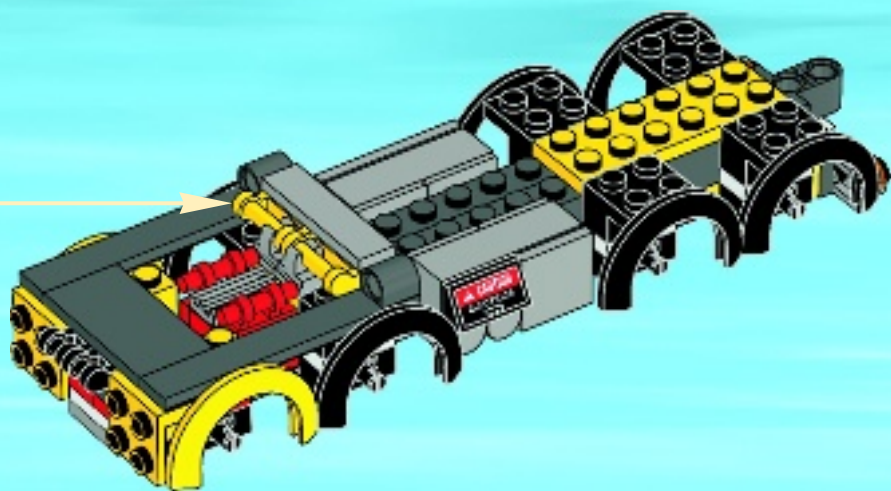



2x



2x

# 27

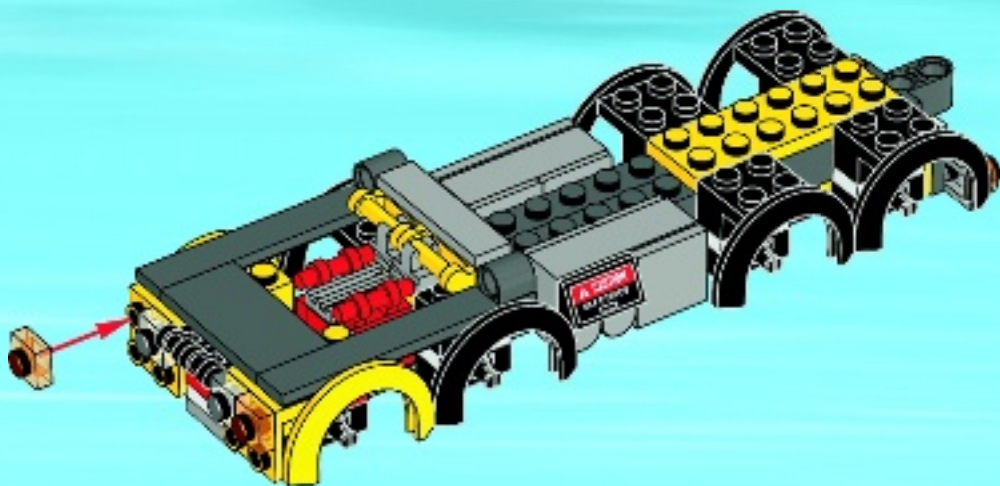



2x

28

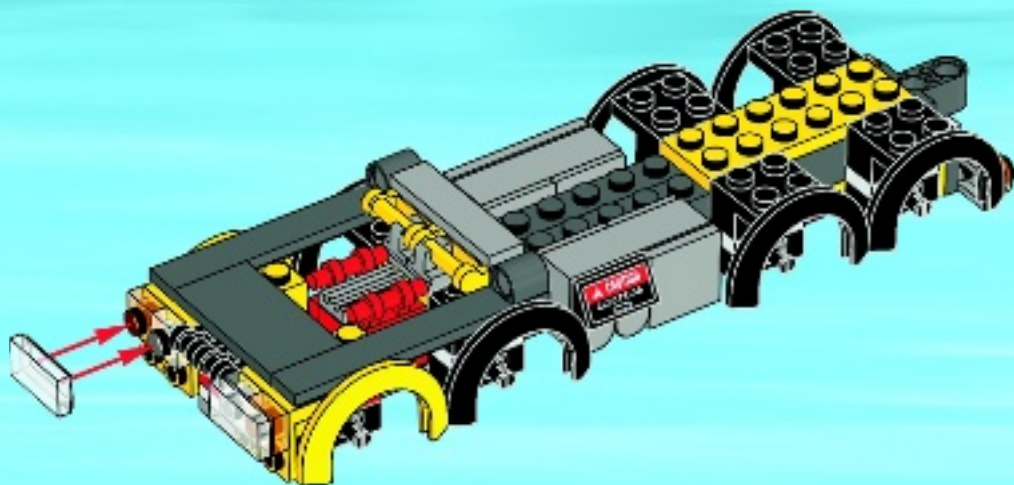

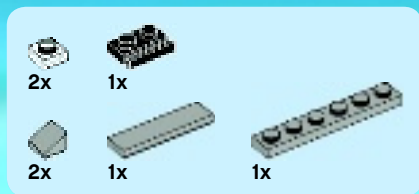

# 29

1

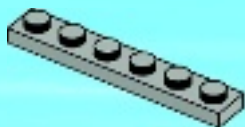

2

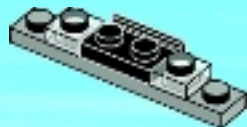

3

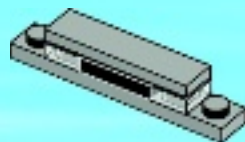

4

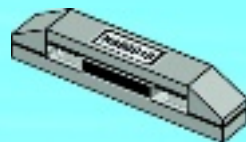

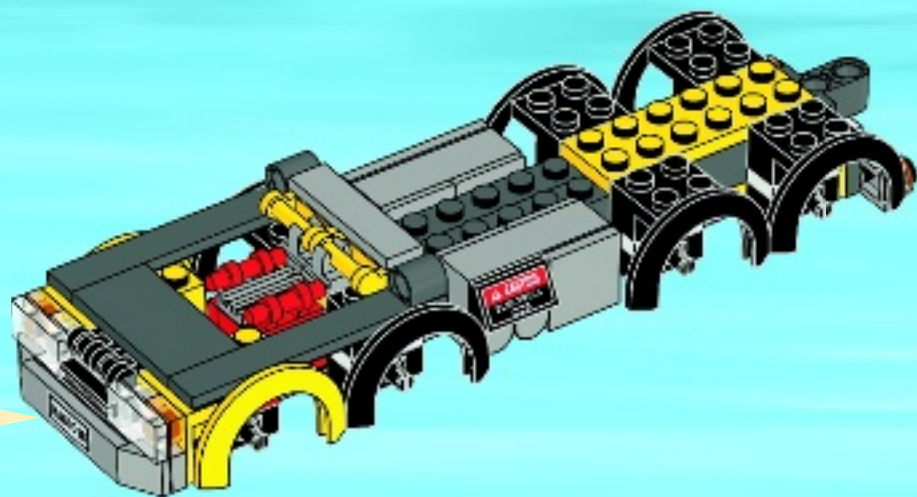

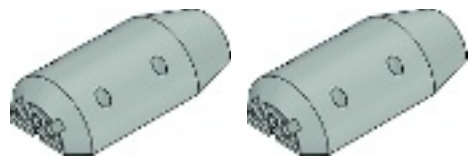

+

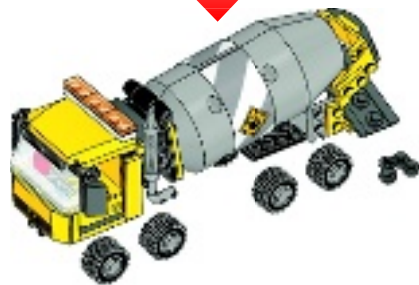

1x



1x

1

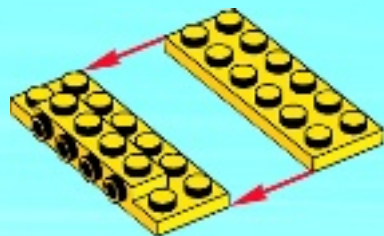



3x

2



1x



1x

3

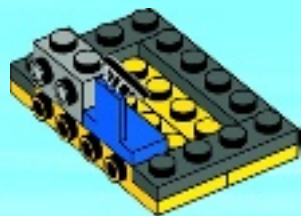



1x



1x



1x

4

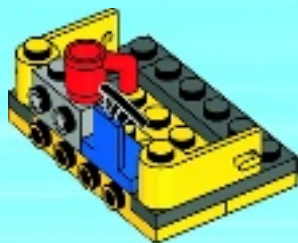





1x

5

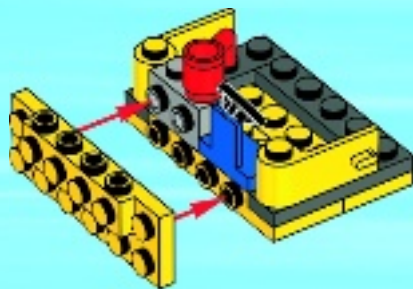

1x

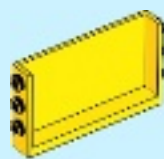

1x

6





2x

7

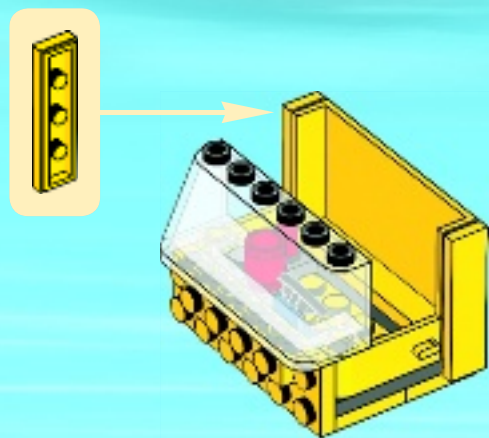



2x

8



2x

9





2x



2x

# 10

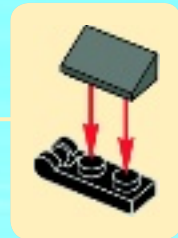
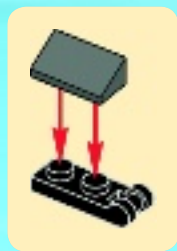

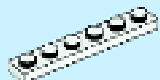

1x



3x



1x



1x

# 11

## 1

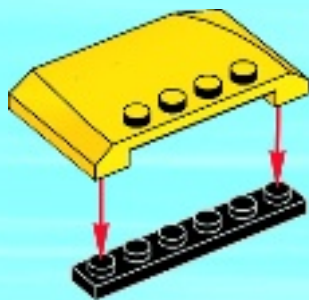

## 2



## 3







2x



2x

12



1x

13





2x

14

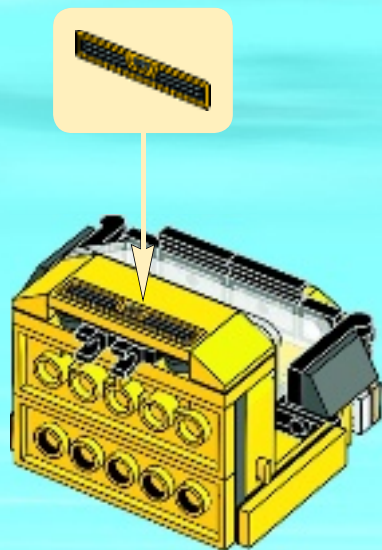



15

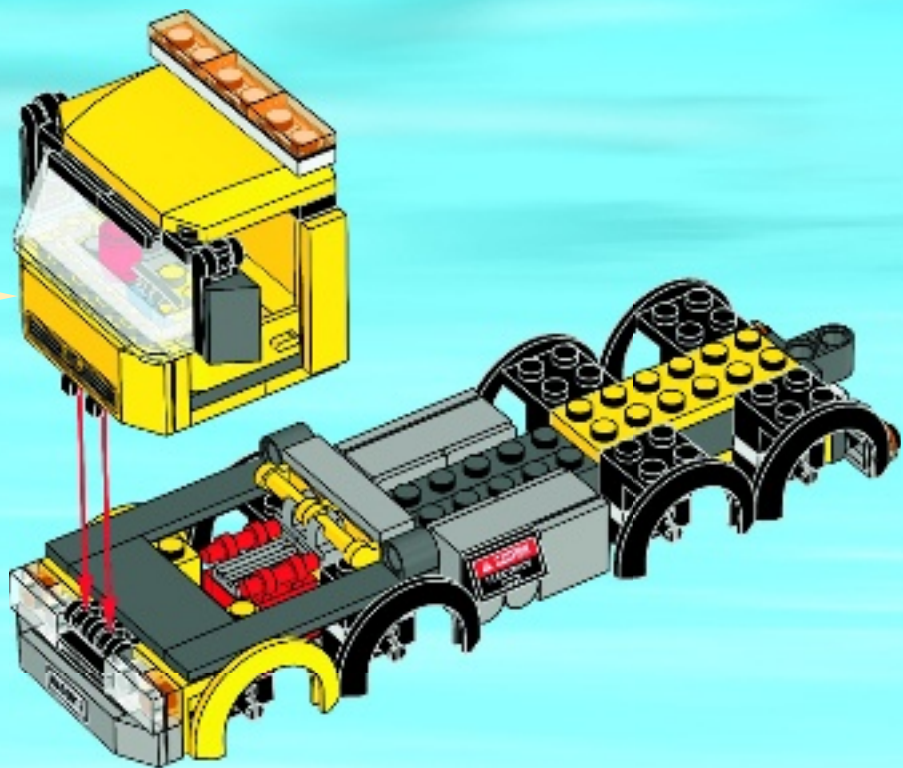



2x

# 16

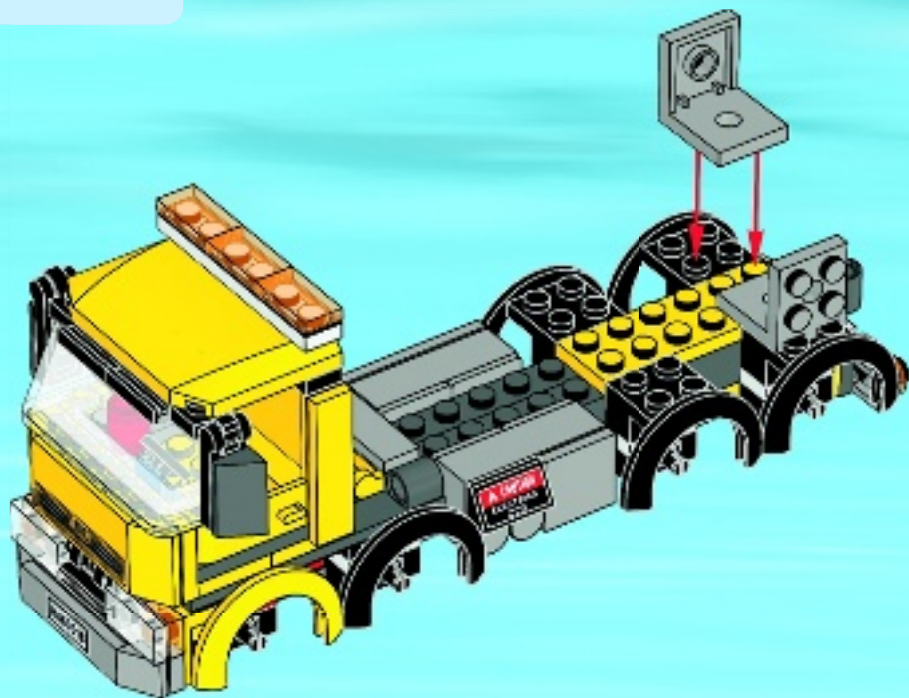



1x

17

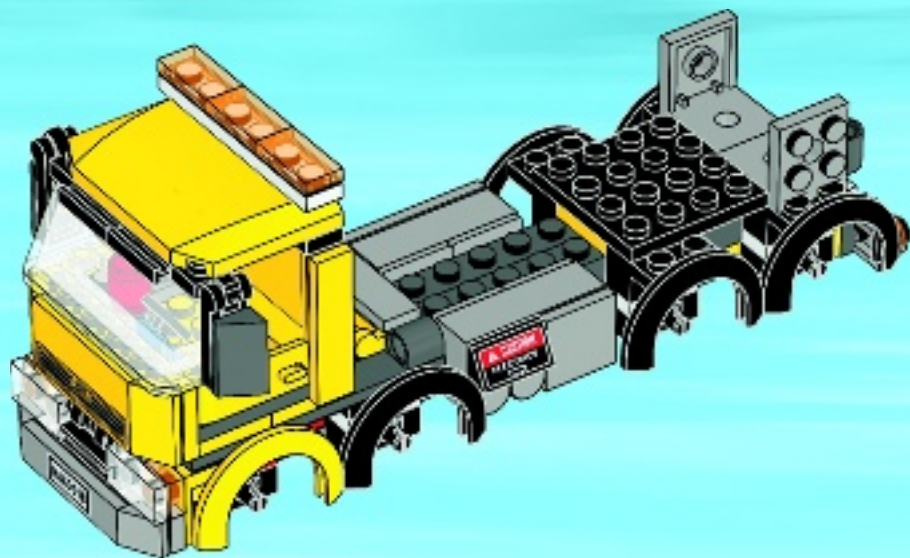

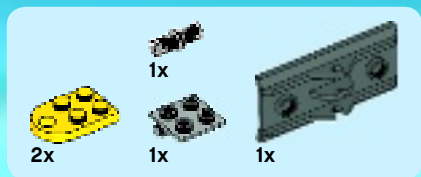

# 18

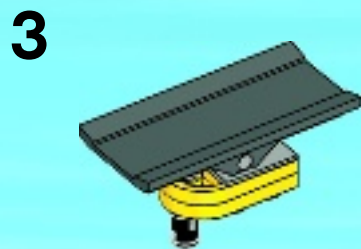
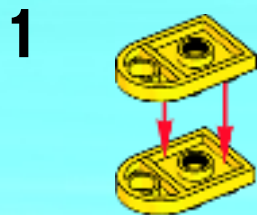

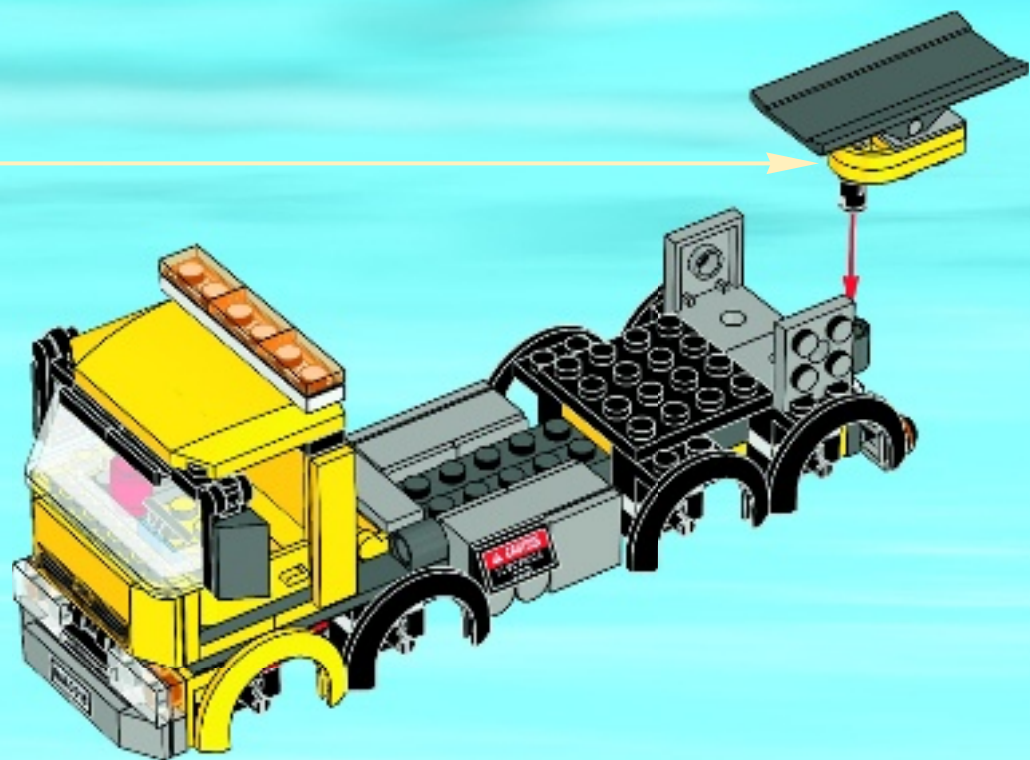



1x



1x

# 19

1



2



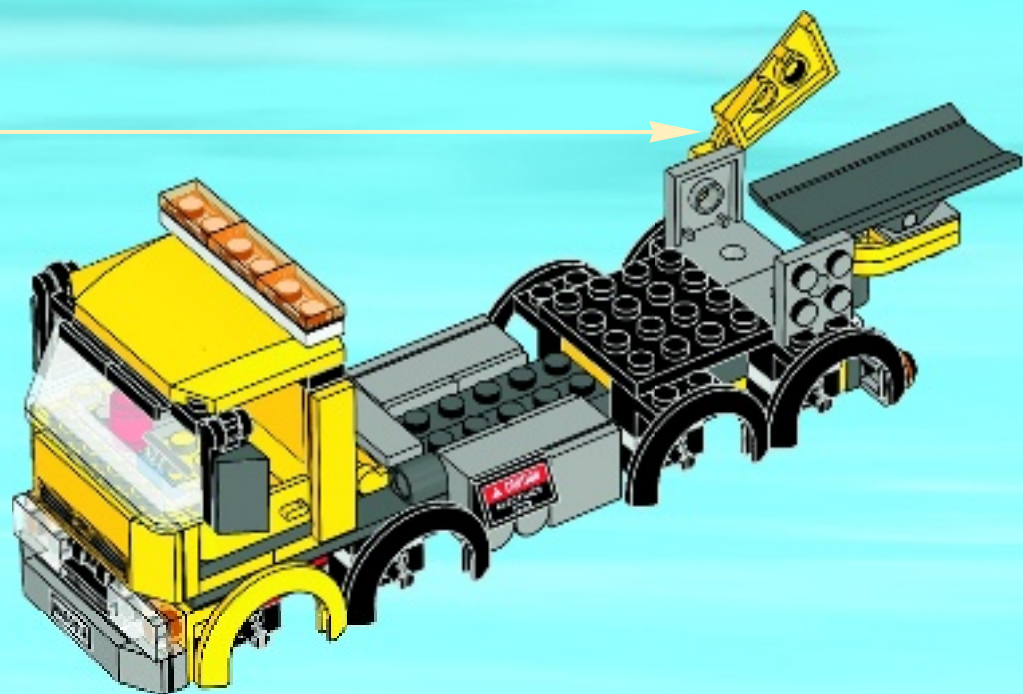



1x



2x



2x

# 20

1



2



3



4

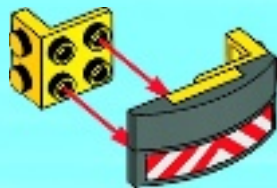



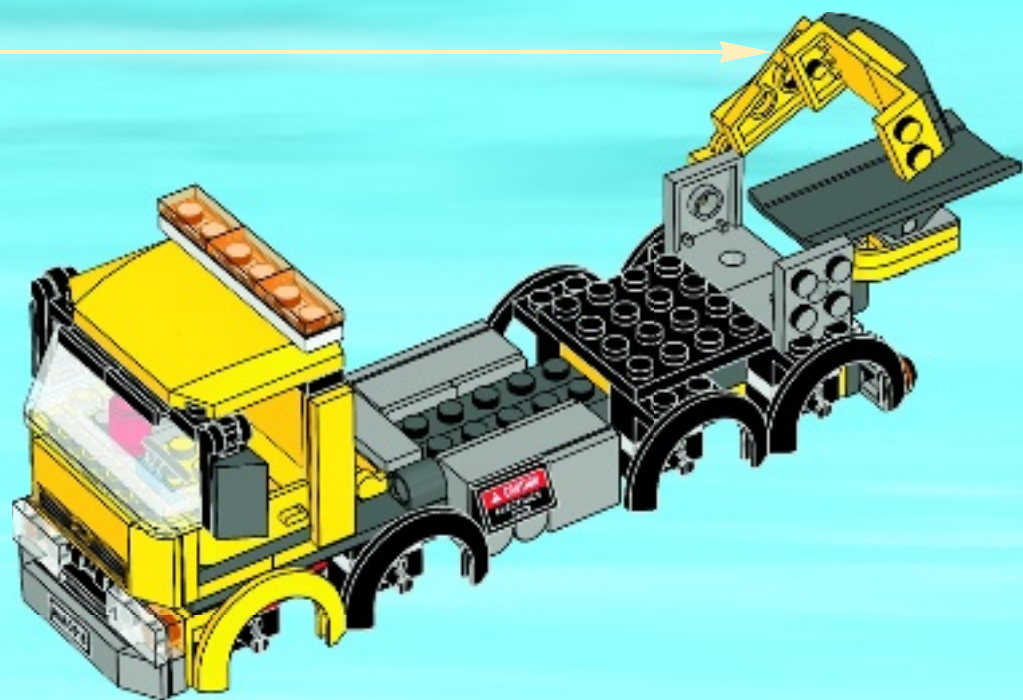



1x



1x

# 21

1

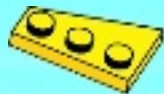

2

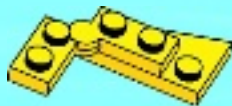

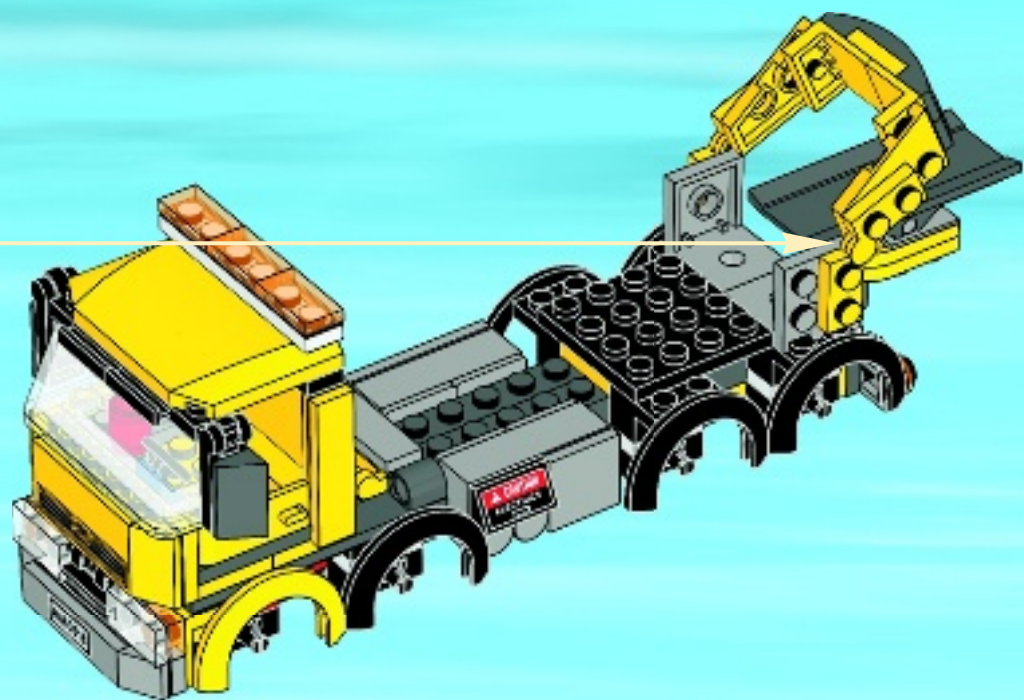



1x



1x

1

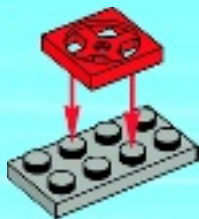

4x

2





1x



1x

3

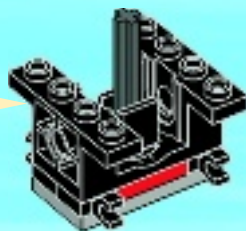
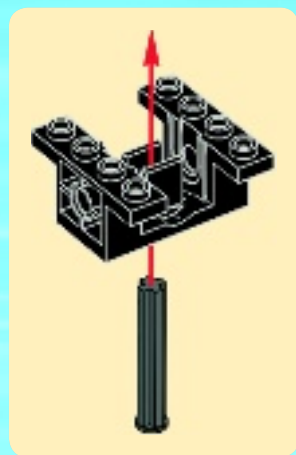



1x

4

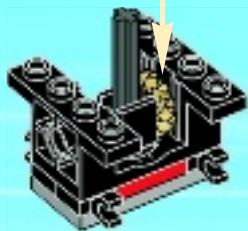

1x

5

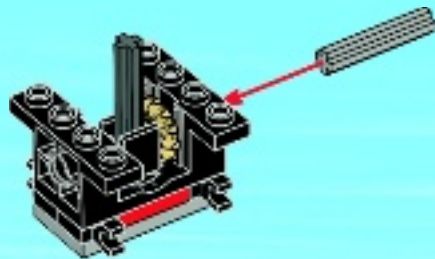



1x

6

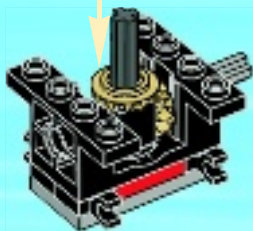

2x

7

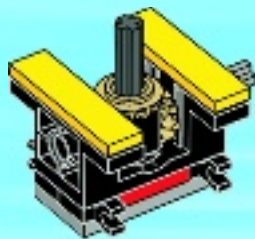



1x



1x

8

1



2

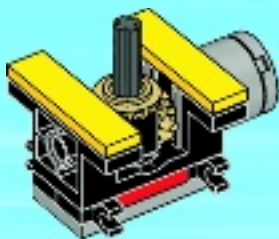



9

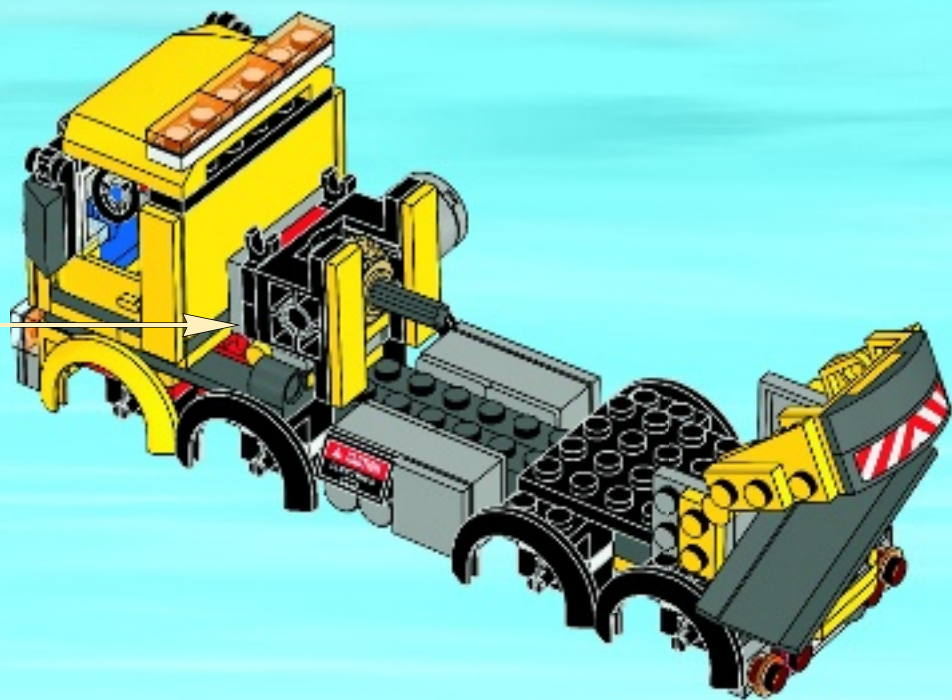

10

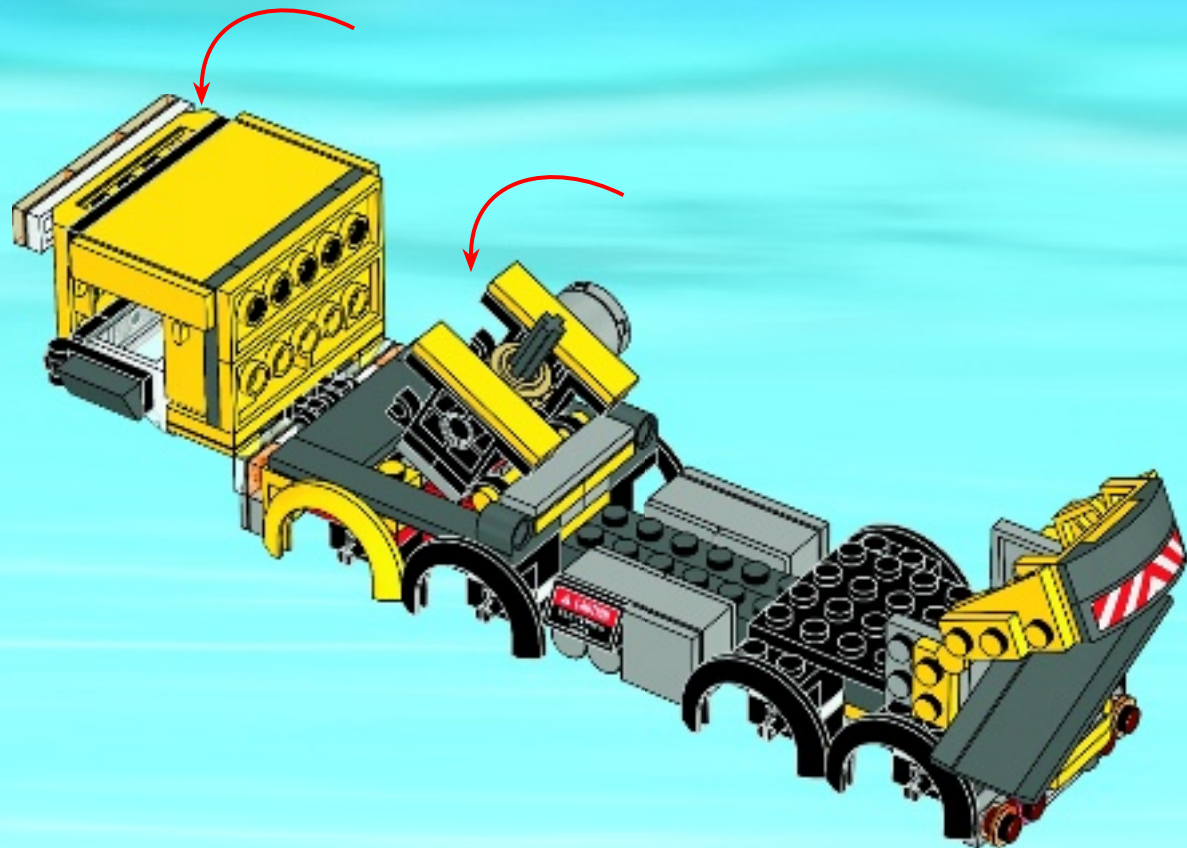



2x



4x



1x

1

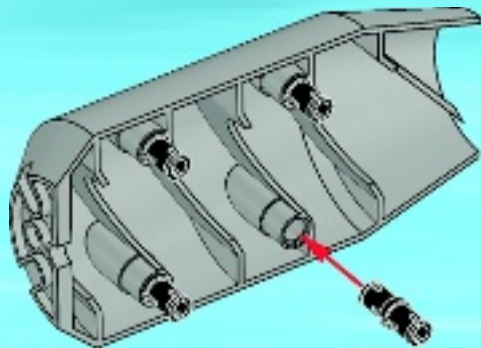

11

**2**

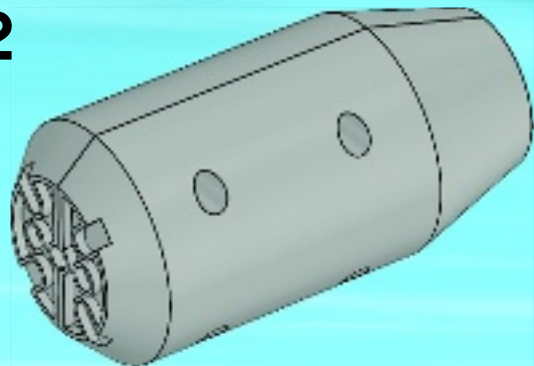

**3**

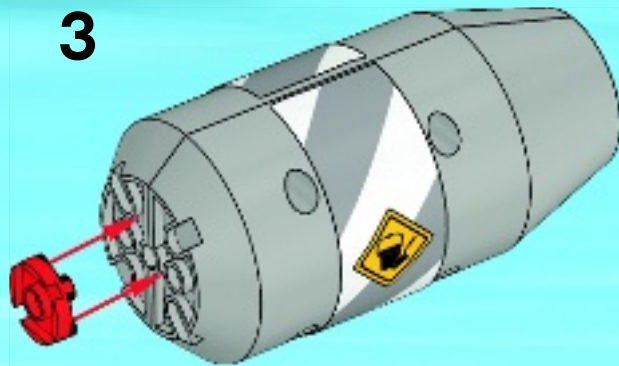

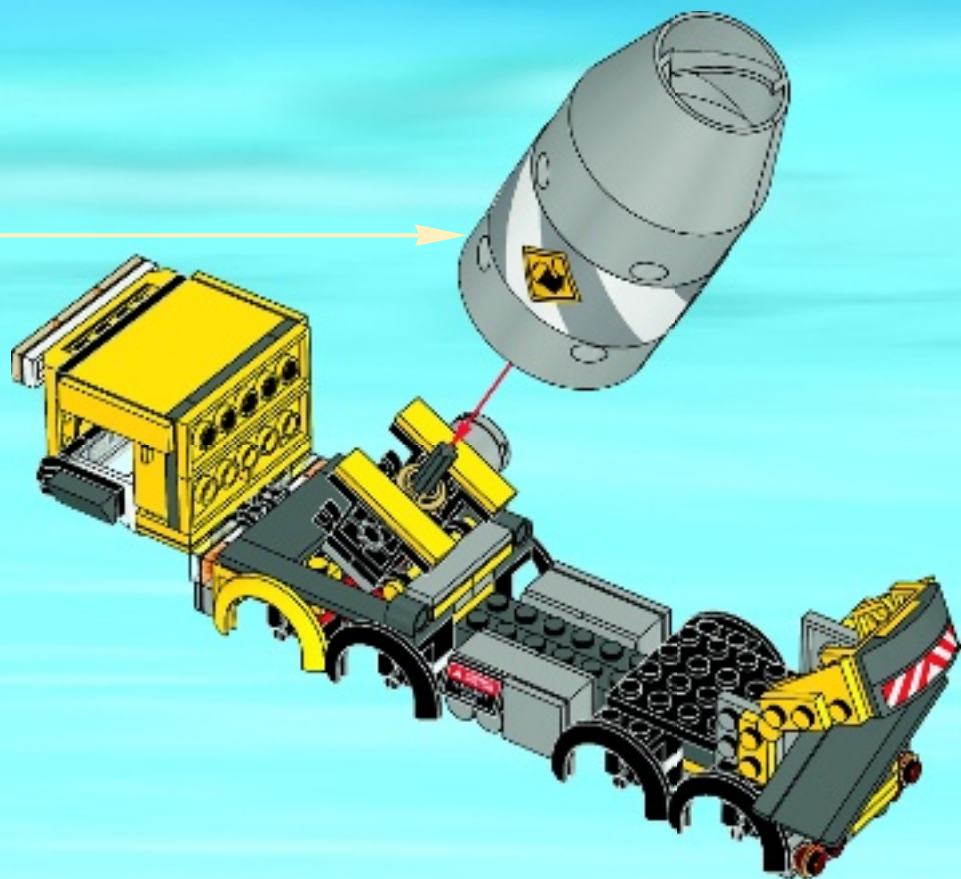



1x

12

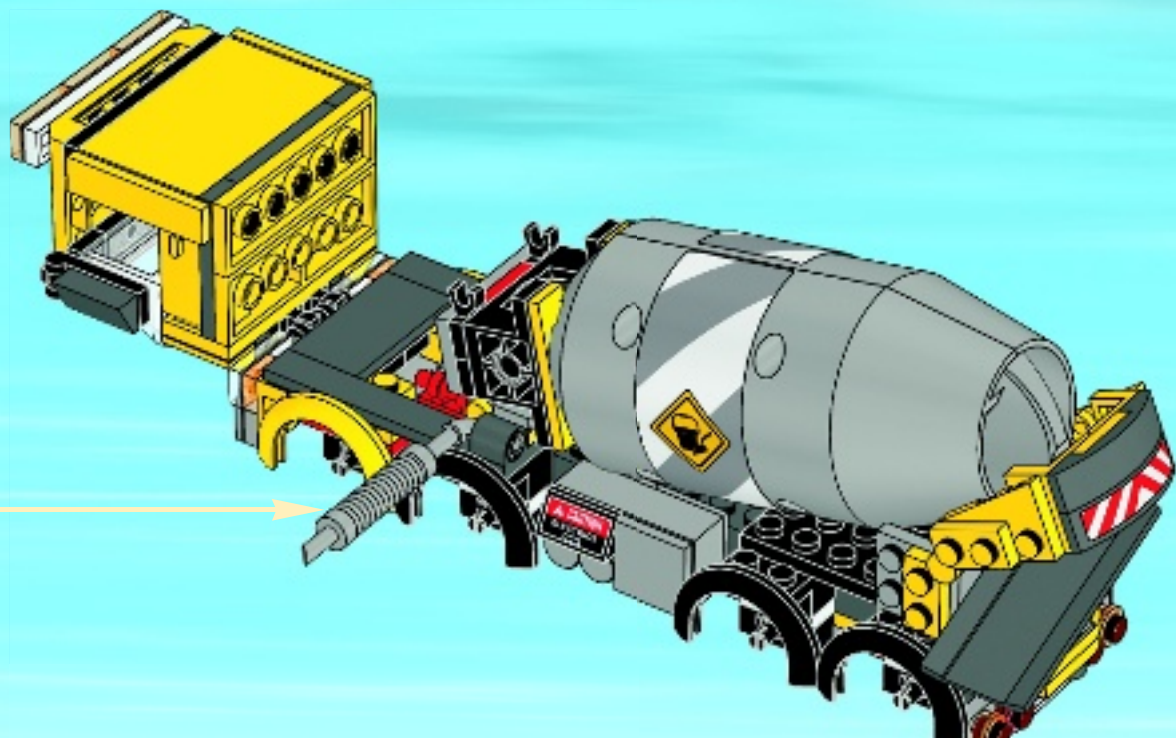



# 13

1

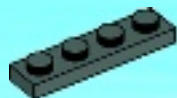

2



3



4



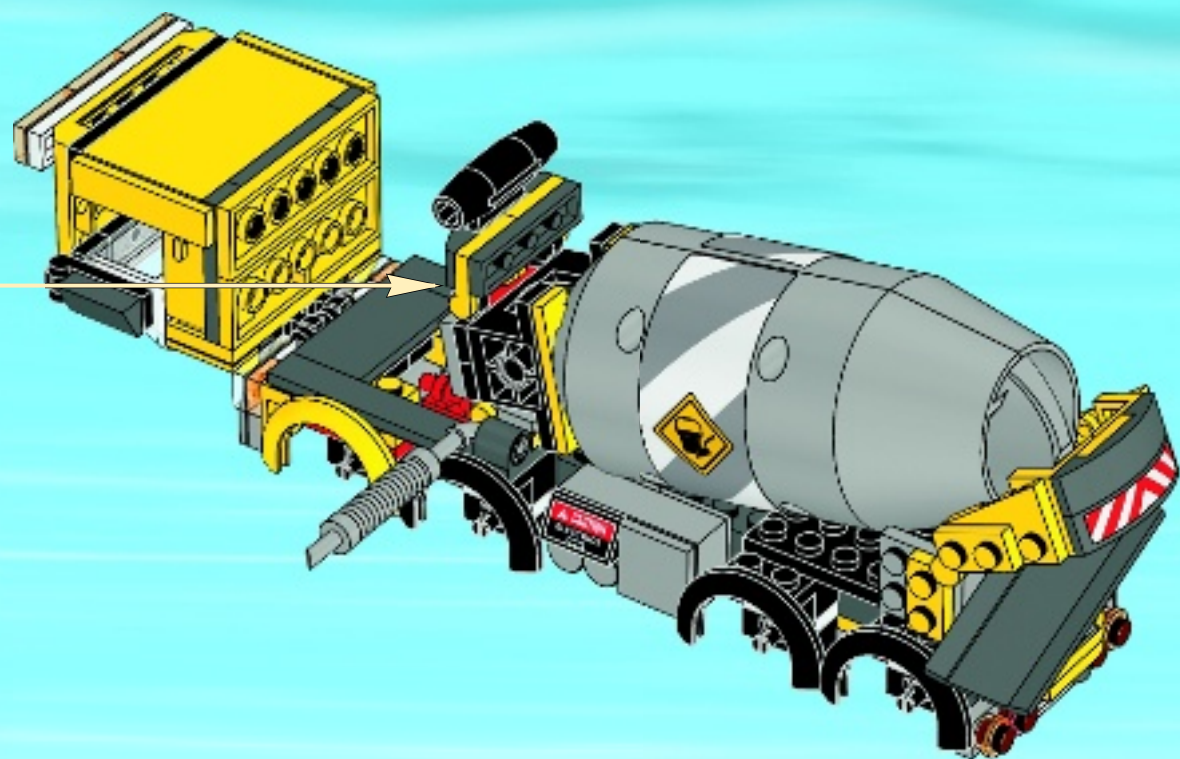





8x



8x

14

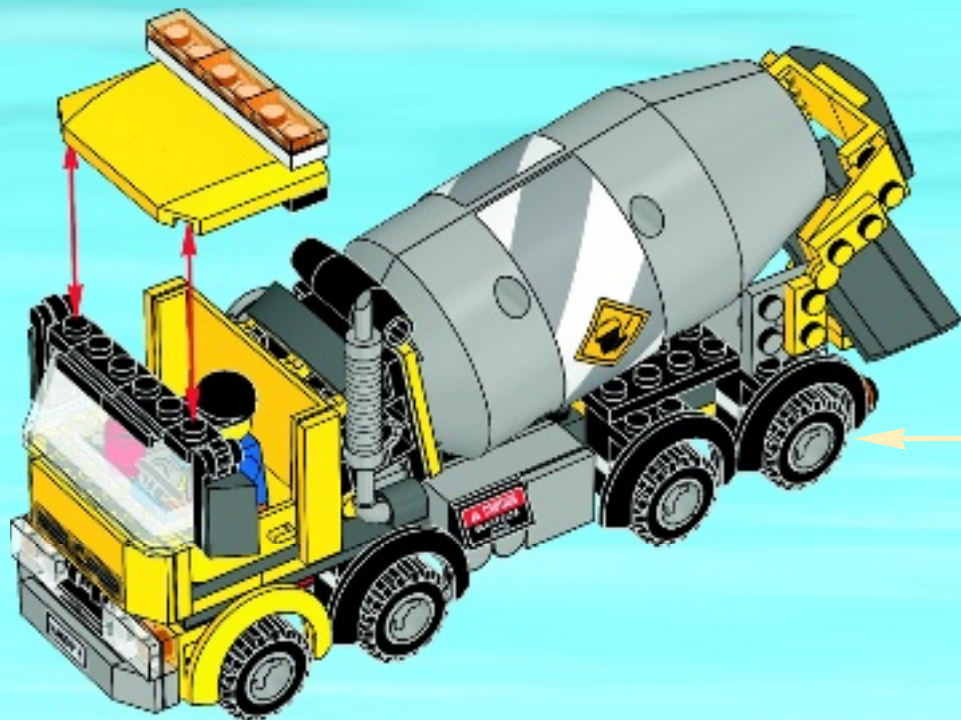

8x



18x

15

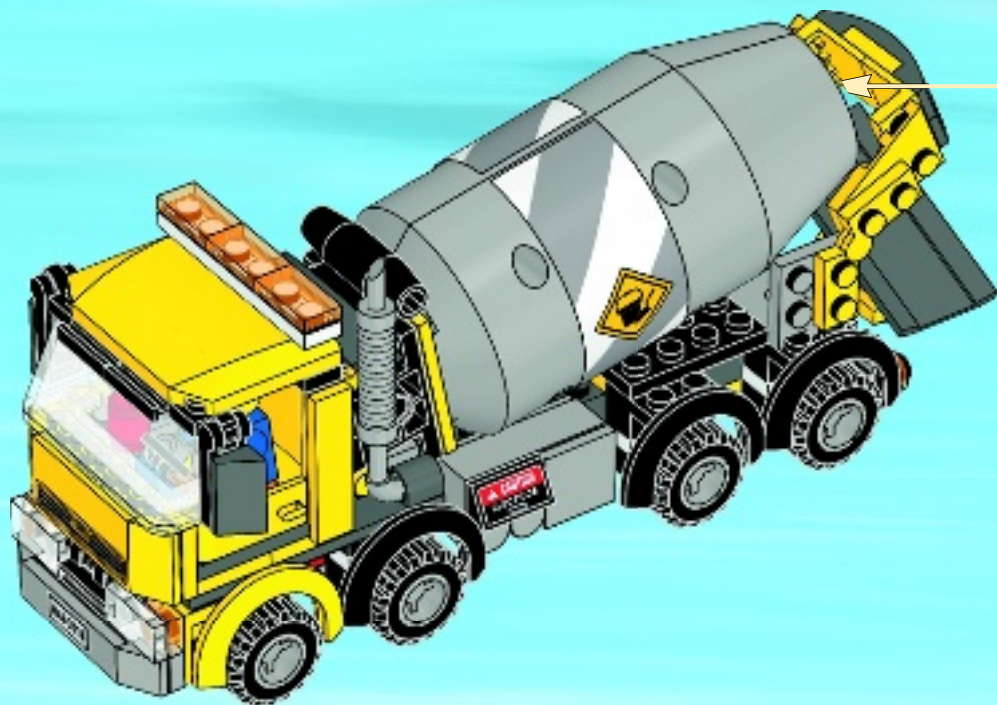

18x

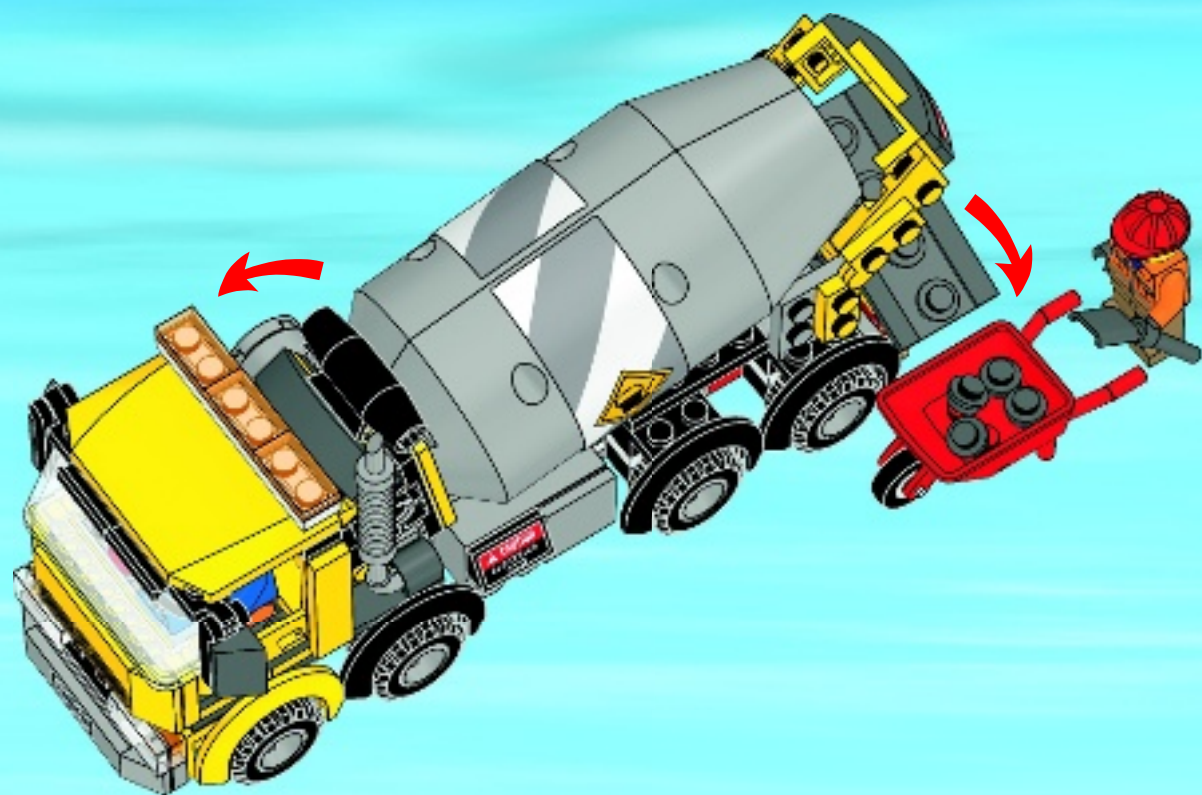

**LEGO** CITY



60016



60017



60018



4432



4433



CITY



6008



6007



6006



10x  
302301



1x  
366601



1x  
306901



1x  
4296997



2x  
4565452



1x  
4569056



3x  
379421



3x  
302121



1x  
403221



2x  
4140585



1x  
383321



1x  
389921



1x  
4646527



1x  
368021



1x  
4275841



1x  
9566



1x  
300424



2x  
4550348



4x  
243124



3x  
4613978



1x  
366624



2x  
379524



2x  
4567996



4x  
4615642



4x  
4501232



2x  
4188313



1x  
4613344



1x  
4560181



2x  
4205196



2x  
4288594



1x  
4179095



1x  
4179094



1x  
4537985



1x  
4190511



1x  
6000724



1x  
4506727



1x  
4263142



1x  
4648114



1x  
4548180



1x  
366626



1x  
4243819



8x  
4517925



5x  
4121715



1x  
4500902



3x  
4107761



4x  
4515368



1x  
4567910



8x  
4568644



1x  
4516843



8x  
448826



6x  
4260488



1x  
4660876



1x  
4524098



1x  
4275843



1x  
4120158



2x  
4598526



2x  
4211385



1x  
4211526



2x  
4521921



2x  
6018688



1x  
4211815



1x  
4211413



1x  
4560183



4x  
4654580



2x  
6019212



2x  
4211356



1x  
4211395



2x  
4211438



1x  
4211486



1x  
4211480



1x  
6015344



1x  
4211350



2x  
4650260



8x  
4211764



1x  
4263192



1x  
4494475



1x  
4211881



1x  
6003058



20x  
4210633



2x  
6019987



2x  
4567887



3x  
4648256



6x  
4211001



1x  
4210763



1x  
4560184



2x  
4210798



1x  
4560177



2x  
4210651



1x  
4211006



4x  
3000840



2x  
4569297



1x  
4502193



2x  
4542673



3x  
4541710



2x  
4222960



2x  
3005741

Customer Service

Kundenservice

Service Consommateurs

Servicio Al Consumidor

LEGO.com/service or dial



: 00800 5346 5555

: 1-800-422-5346



# WIN!

Go to [www.LEGOsurvey.com/product](http://www.LEGOsurvey.com/product) to fill out a survey for a chance to win a cool LEGO® Product.

No purchase necessary.

Open to all residents where not prohibited.



## [www.LEGOsurvey.com/product](http://www.LEGOsurvey.com/product)

### GEWINNE!

Nimm an der Umfrage auf [www.LEGOsurvey.com/product](http://www.LEGOsurvey.com/product) teil und hab die Chance ein cooles LEGO® Produkt zu gewinnen!

Die Teilnahme am Gewinnspiel führt zu keinerlei Kaufverpflichtungen. Teilnahme in allen nicht ausgeschlossenen Ländern möglich.

### WIN!

Ga naar [www.LEGOsurvey.com/product](http://www.LEGOsurvey.com/product), vul een enquêteformulier in en maak kans op een cool LEGO® product.

Geen aankoopverplichting. Iedereen mag deelnemen, uitgezonderd ingezetenden van landen waar een enquêteverbod geldt.

### GAGNE!

Visite [www.LEGOsurvey.com/product](http://www.LEGOsurvey.com/product) pour répondre à un questionnaire et avoir une chance de gagner un produit LEGO® très cool!

Aucune obligation d'achat. Ouvert à tous les résidents des pays autorisés.

### 当てよう!

[www.LEGOsurvey.com/product](http://www.LEGOsurvey.com/product) にアクセスして、アンケートにご記入ください。当選者にはレゴ®製品を差し上げます。

お買い上げの必要はありません。禁止されていない限り、すべての皆様にご利用いただけます。



LEGO.com

6033627

LEGO and the LEGO logo are trademarks of the LEGO Group. ©2013 The LEGO Group.