

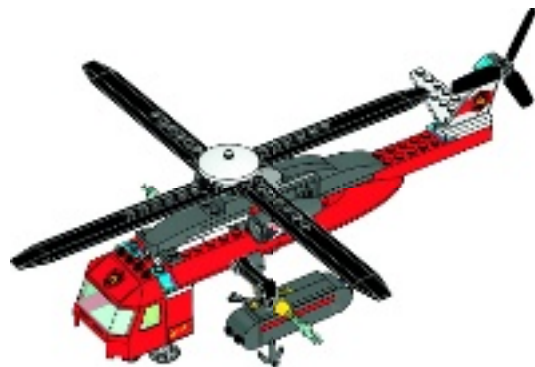

# CITY

60010





2x

# 29

1



2

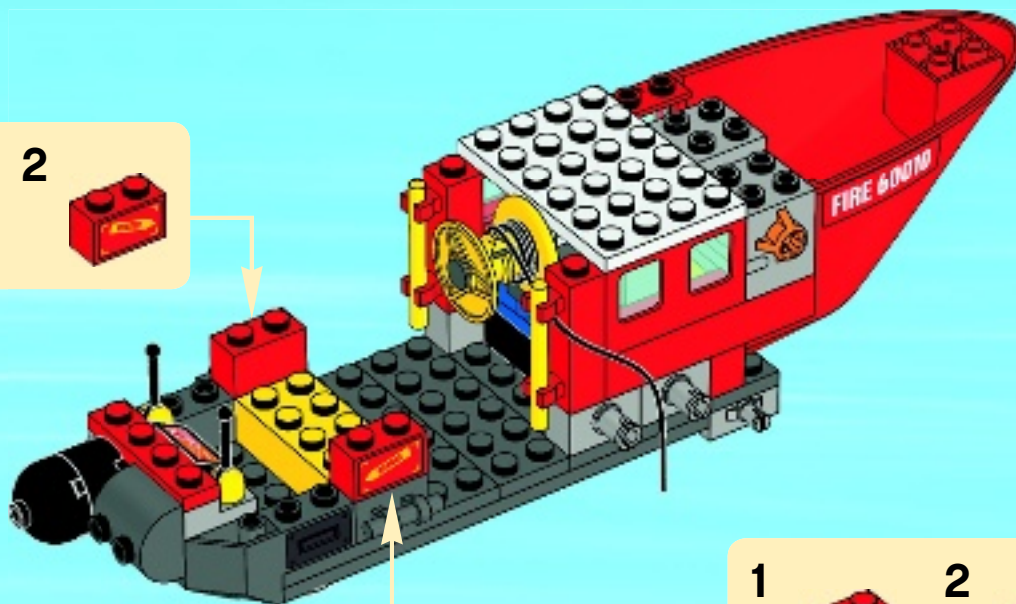

1



2





1x

# 30

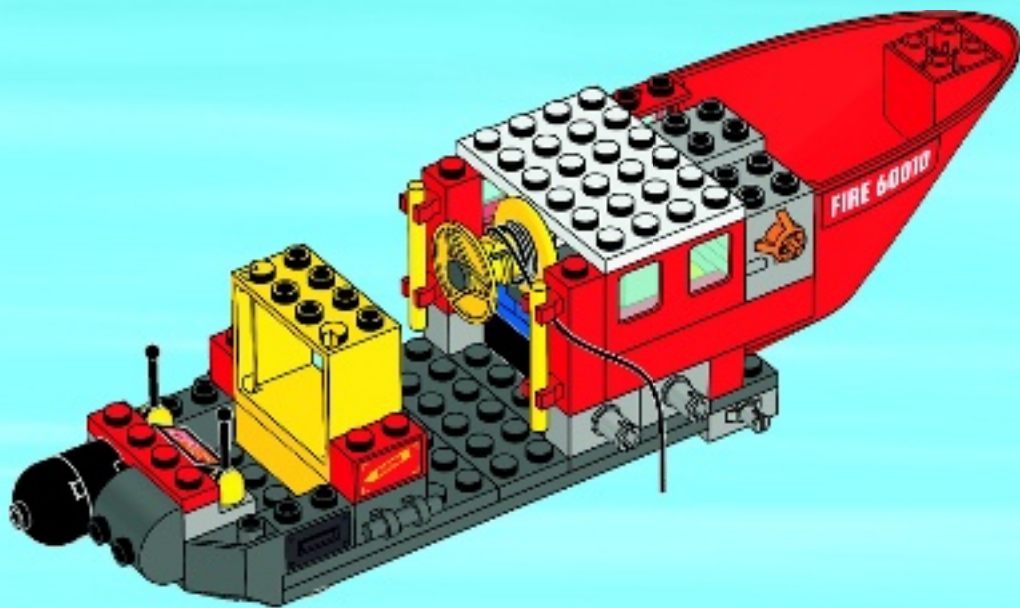



2x

# 31

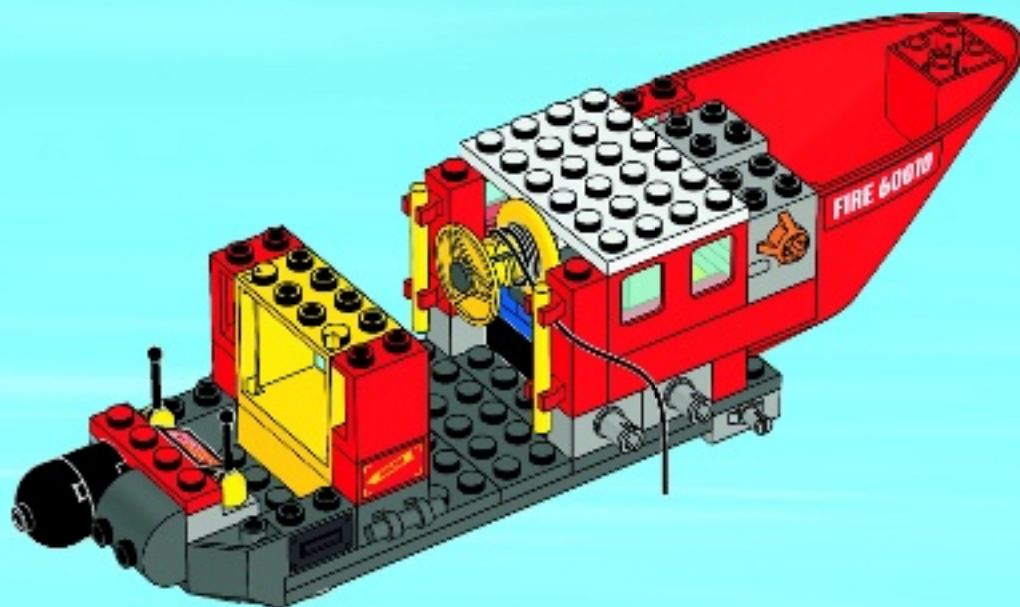



2x

# 32

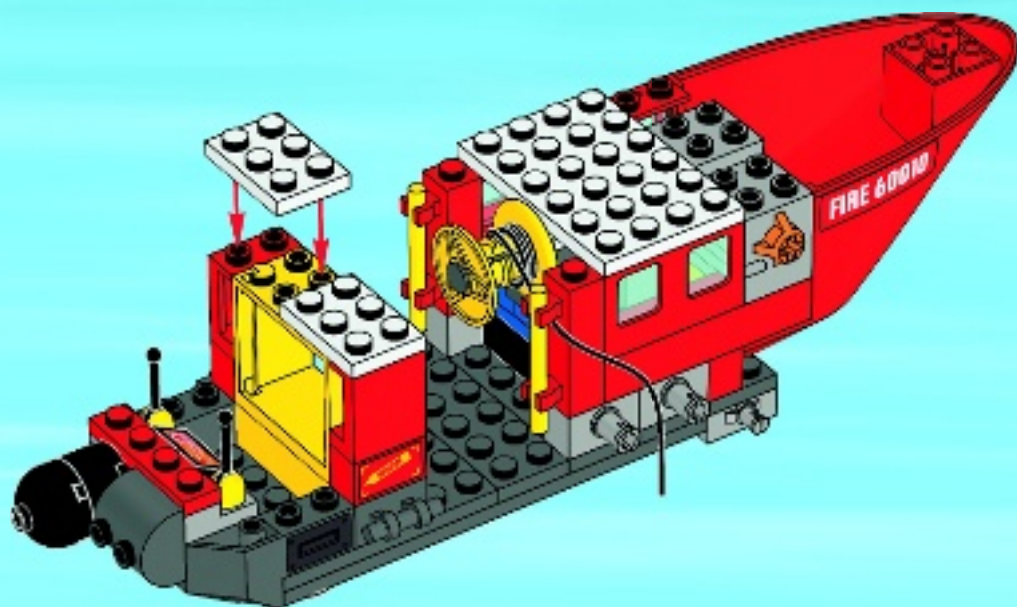



2x



1x

# 33

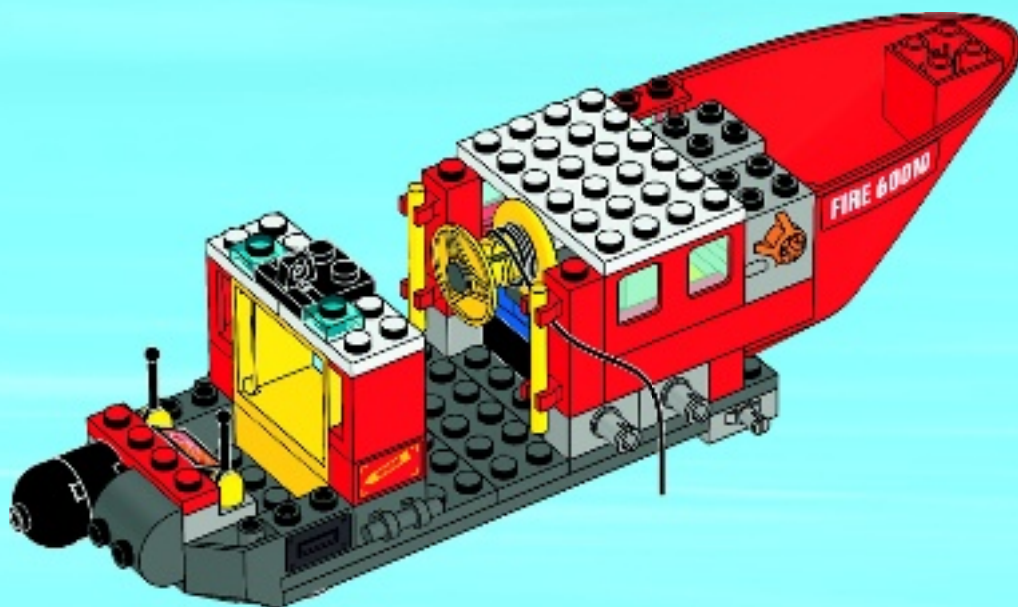



1x



2x

# 34

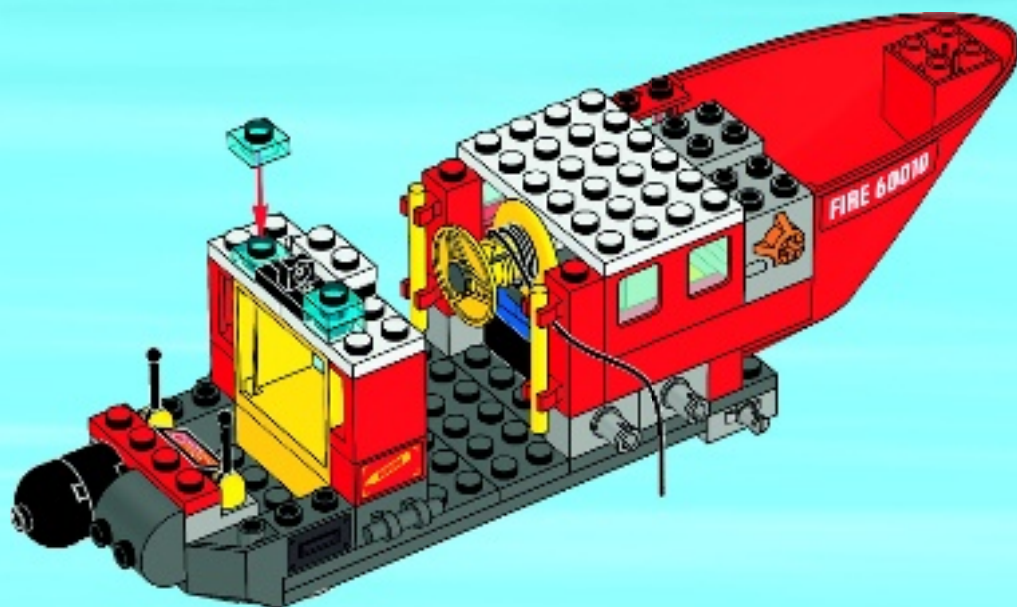



2x

# 35

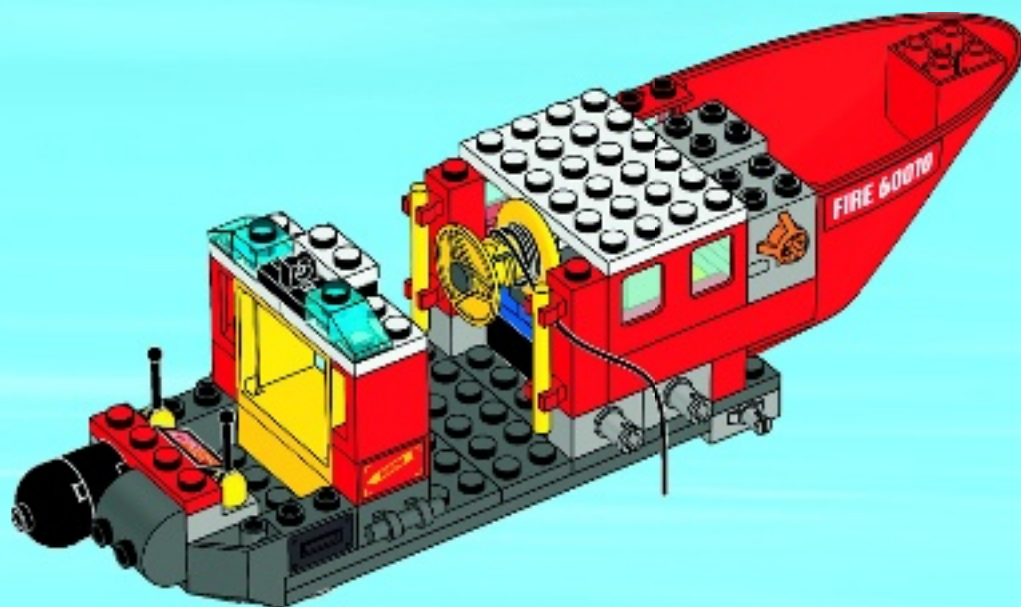



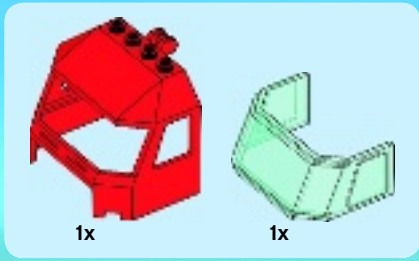

36

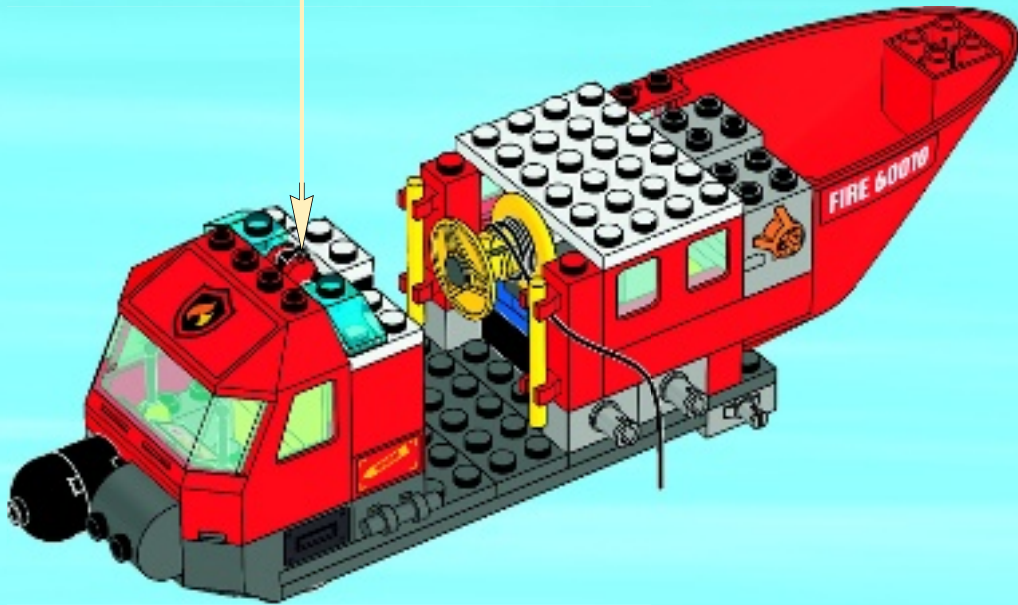
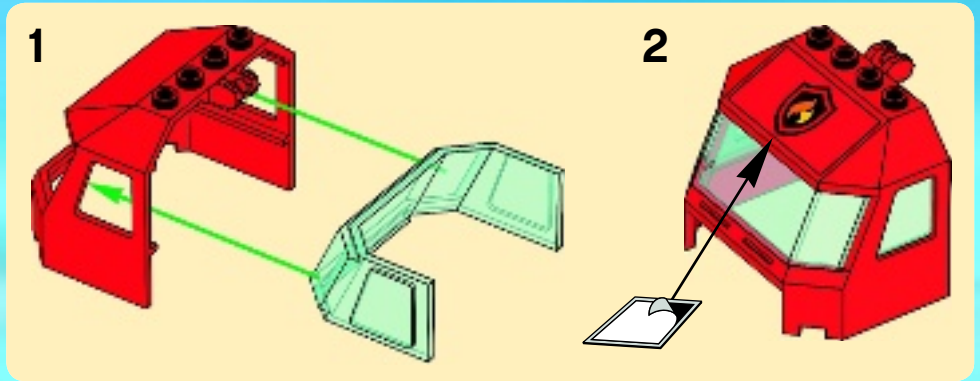



1x



1x

# 37

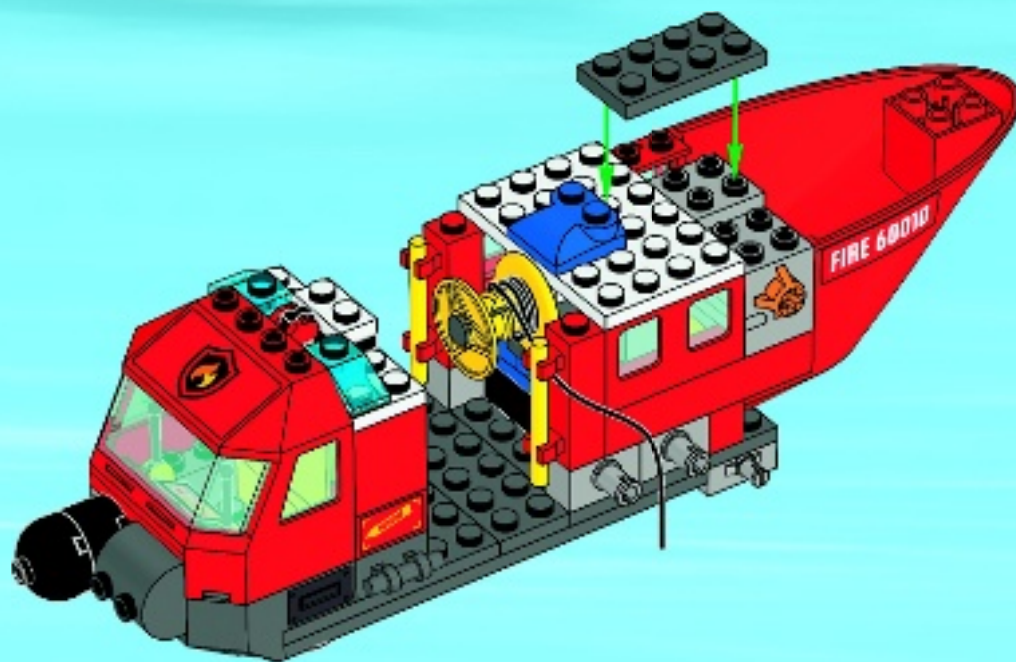



2x

# 38

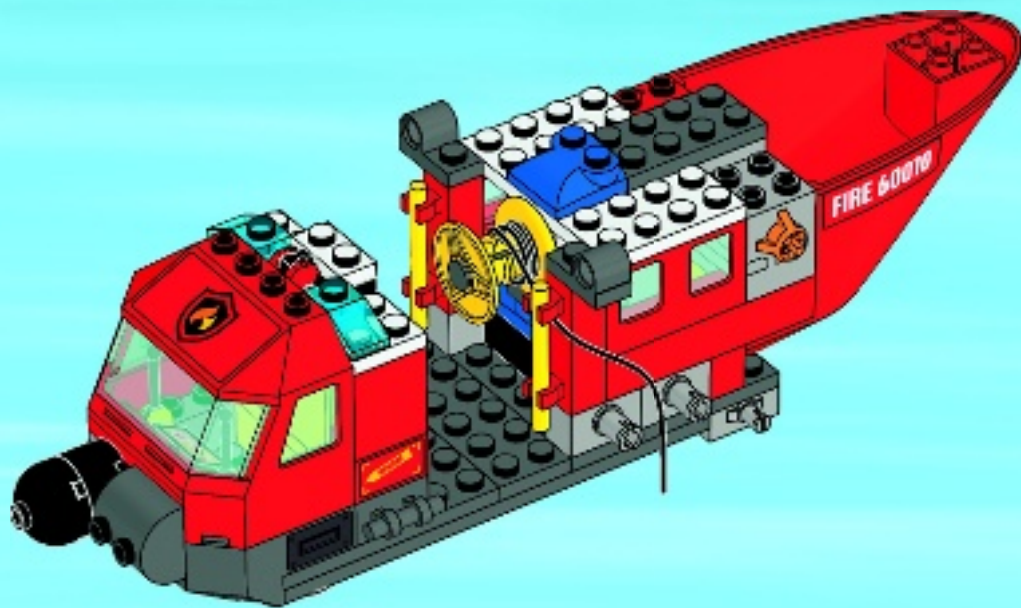

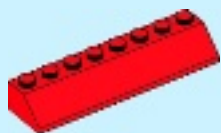

2x

39

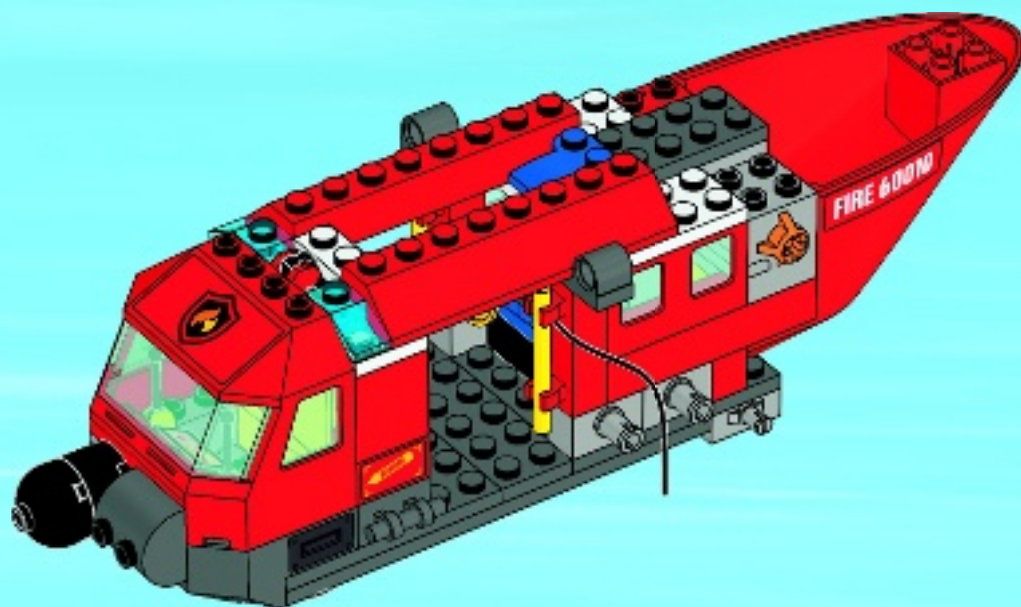



4x

40

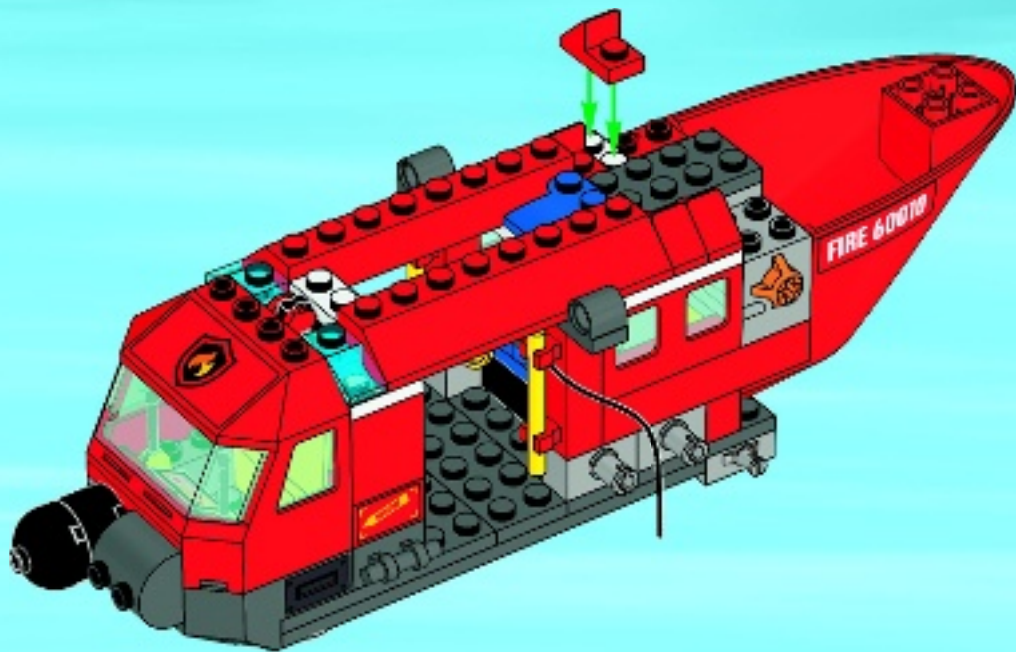



2x



1x

# 41

1



2

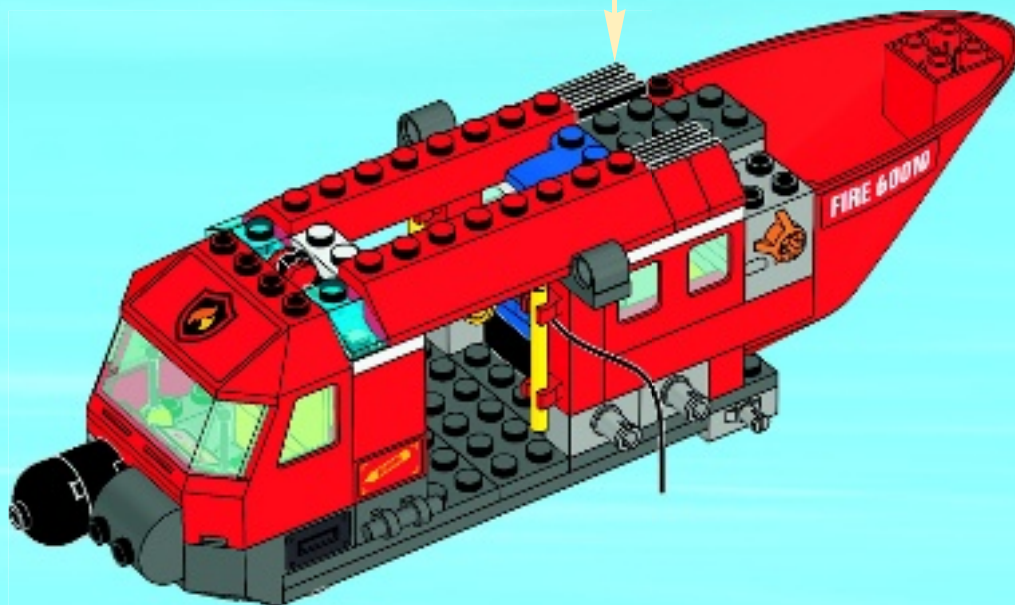

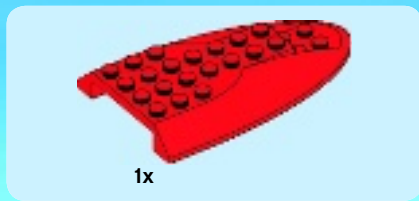

42

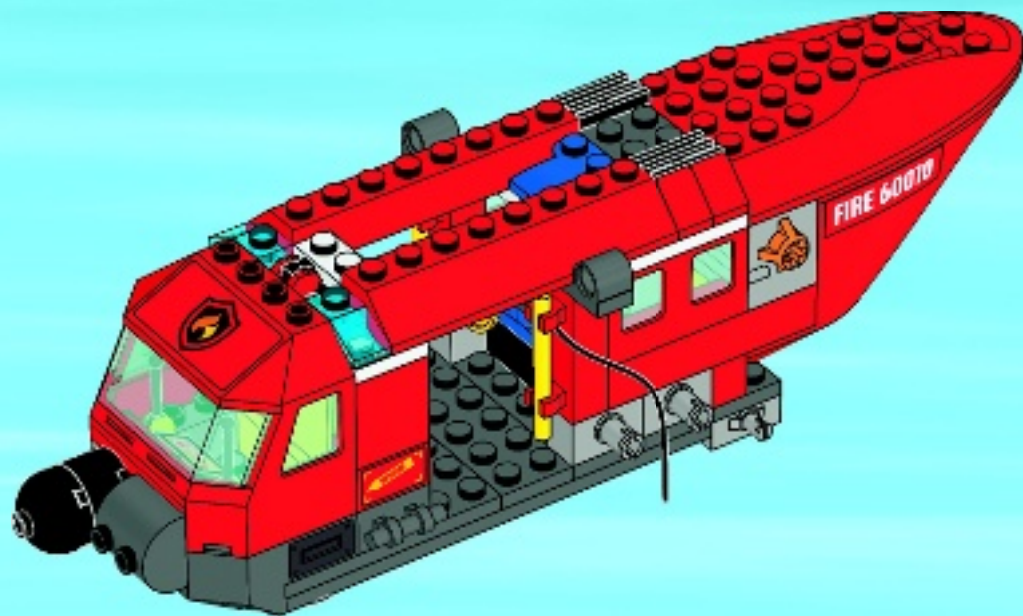



1x



1x

# 43

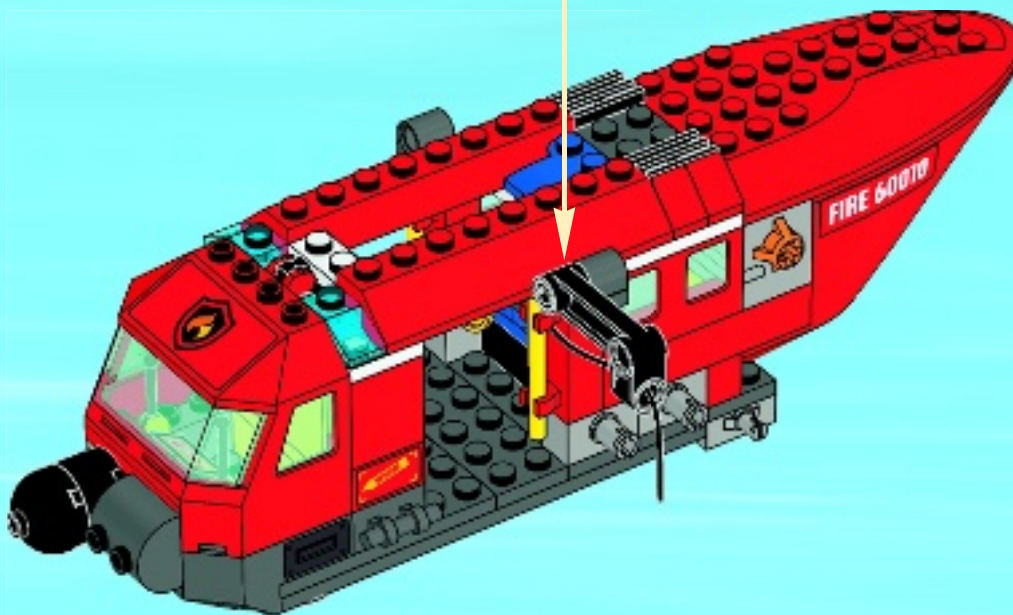
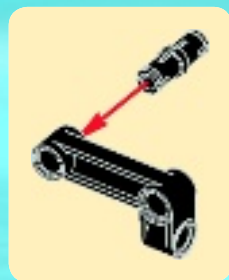





1x

44

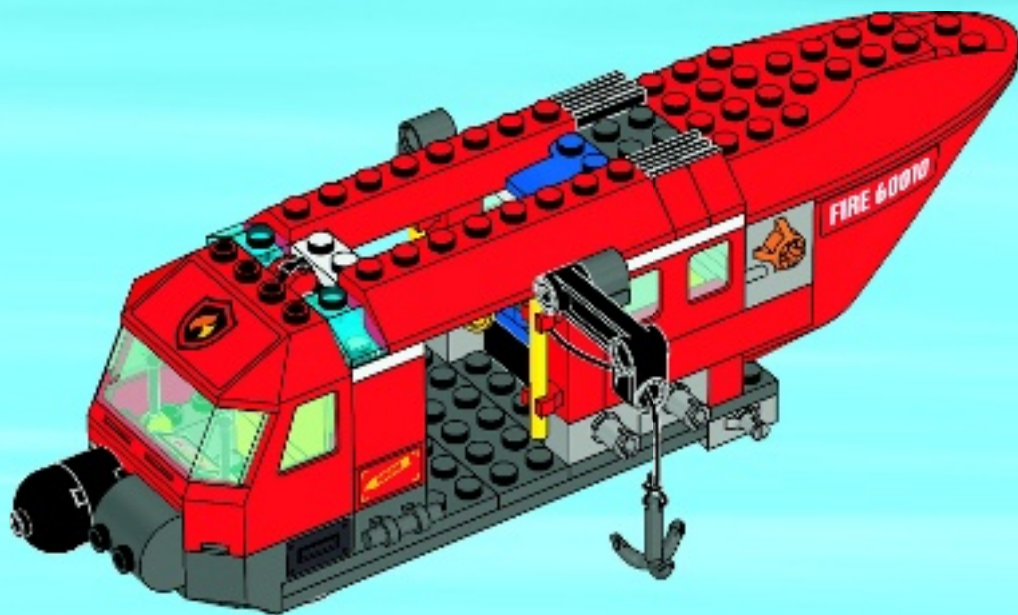
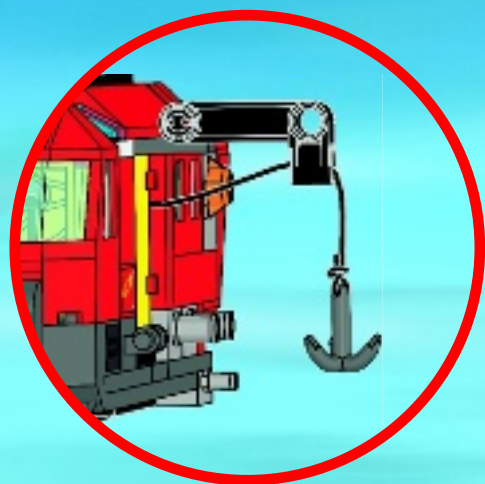

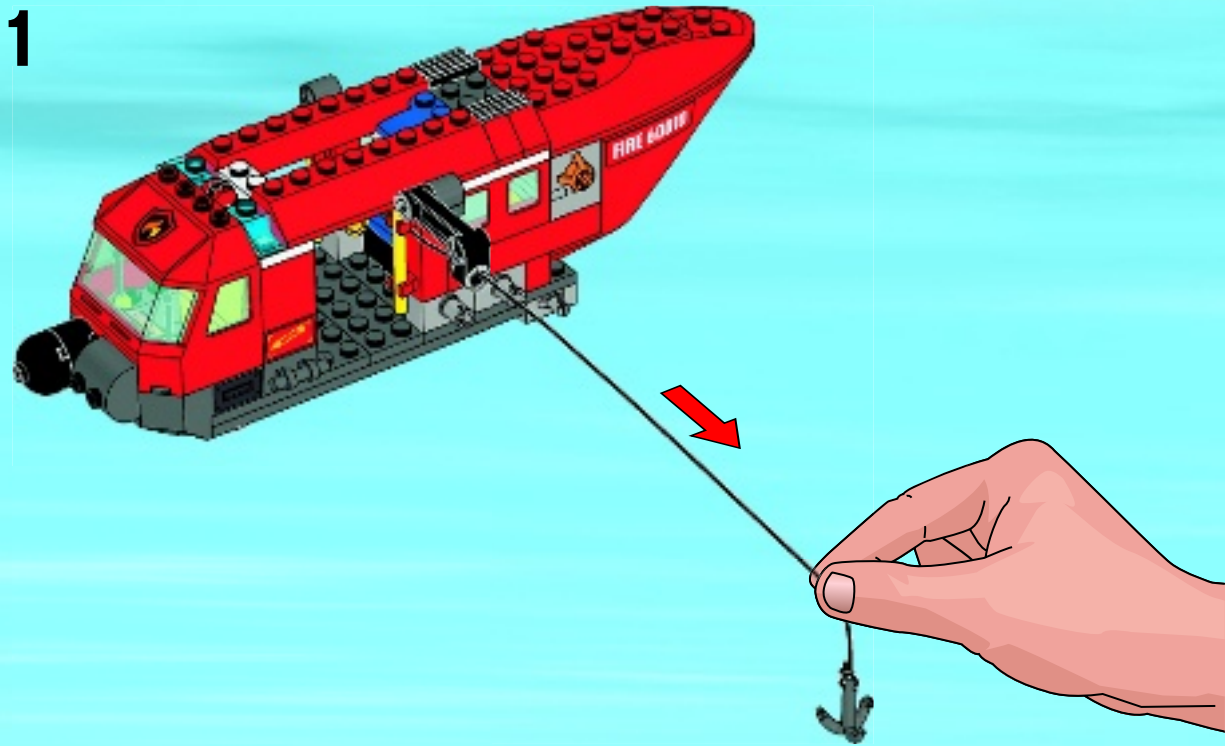

2

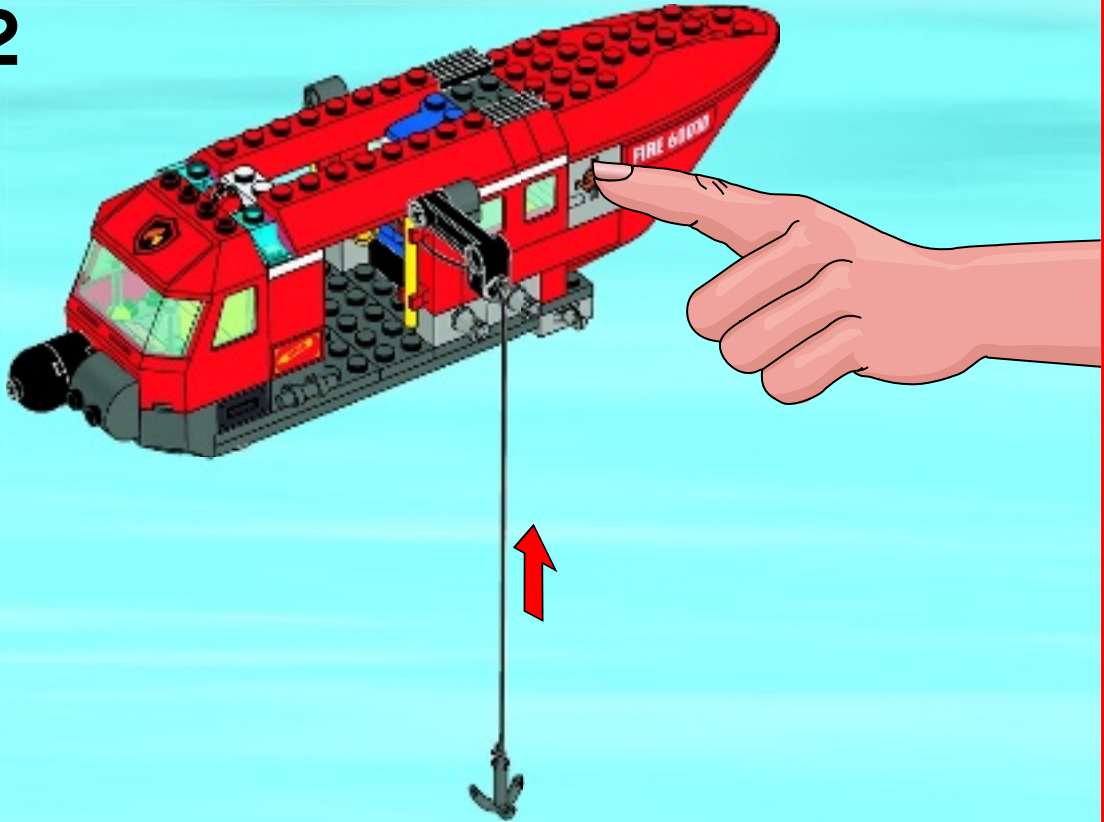



1x



1x

# 45

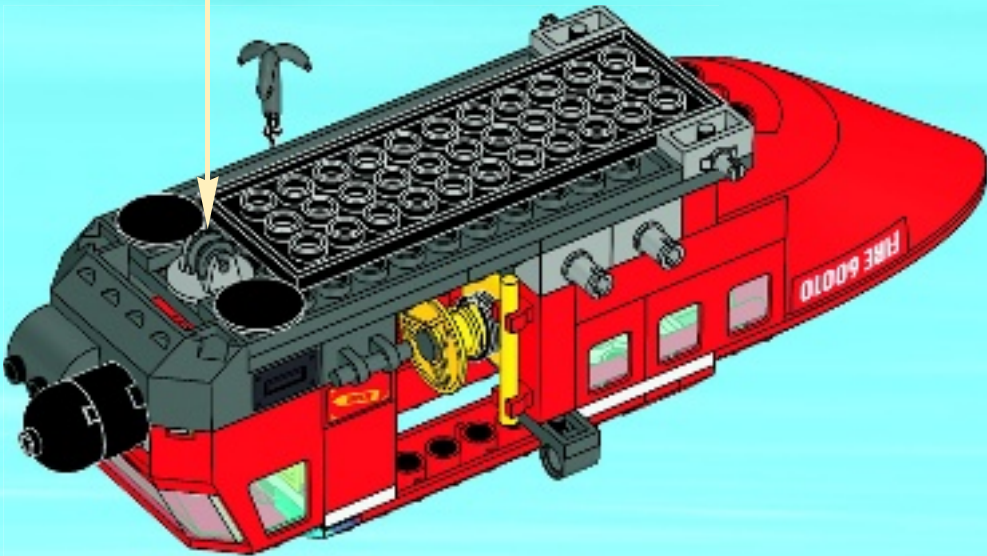
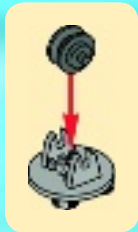



2x

# 46

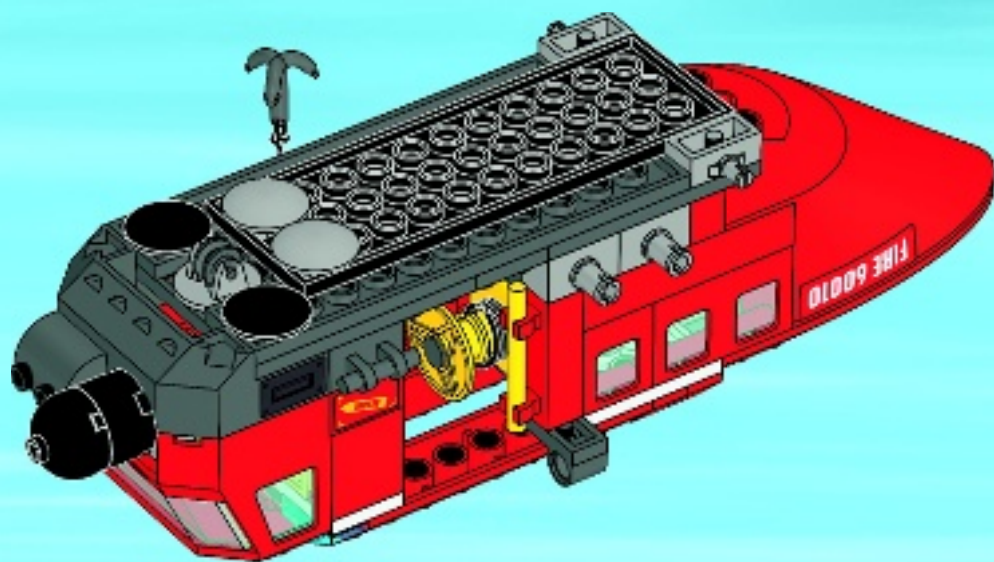



2x



2x

# 47



2x

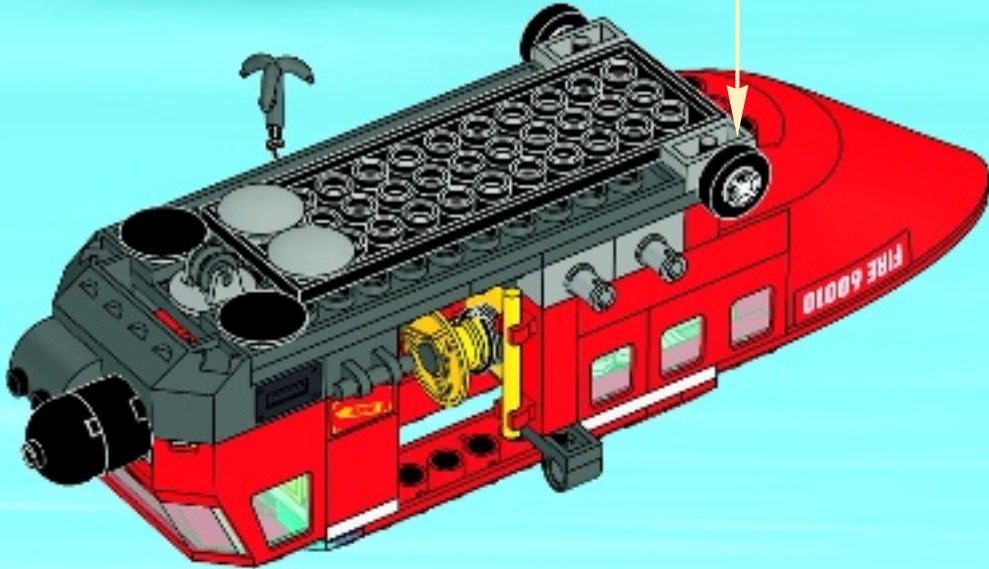

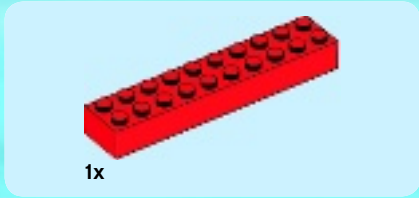

1x

1

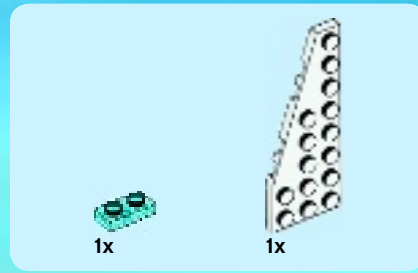
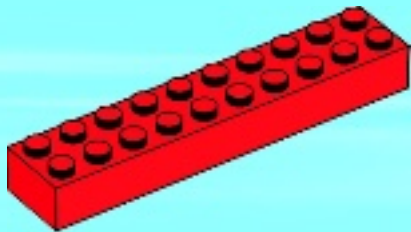

1x

1x

2

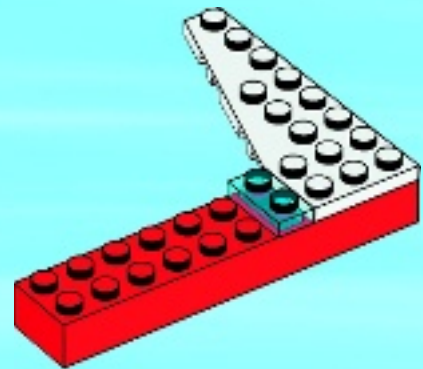

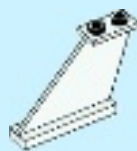

1x

3

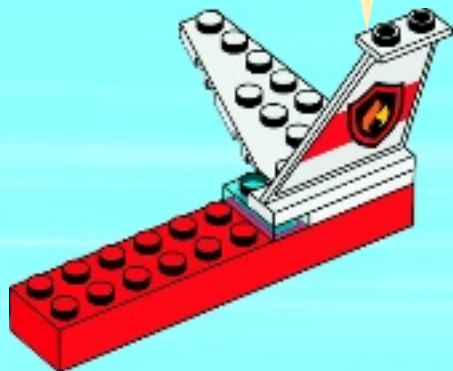
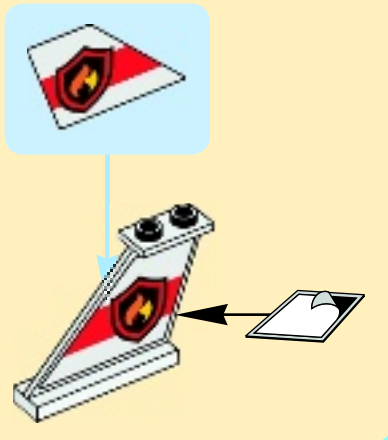

1x

4

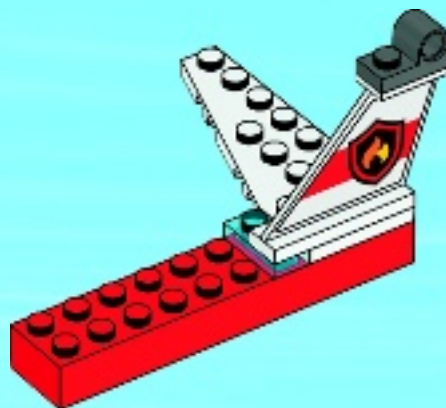





1x



1x

5

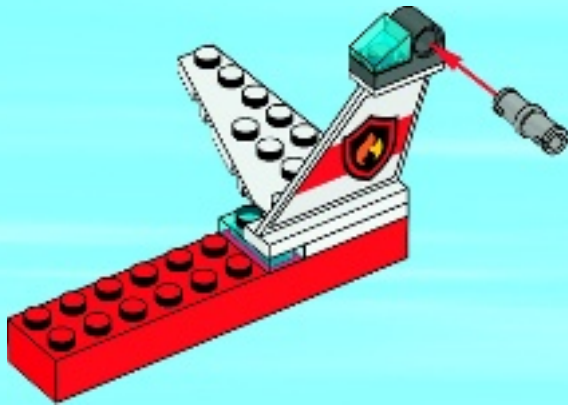

1x

6

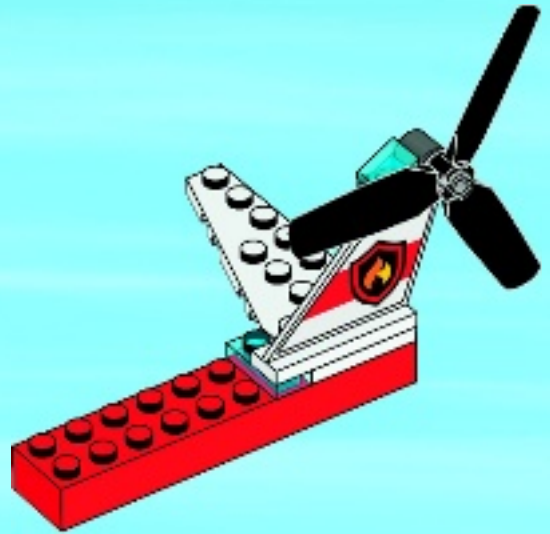

48

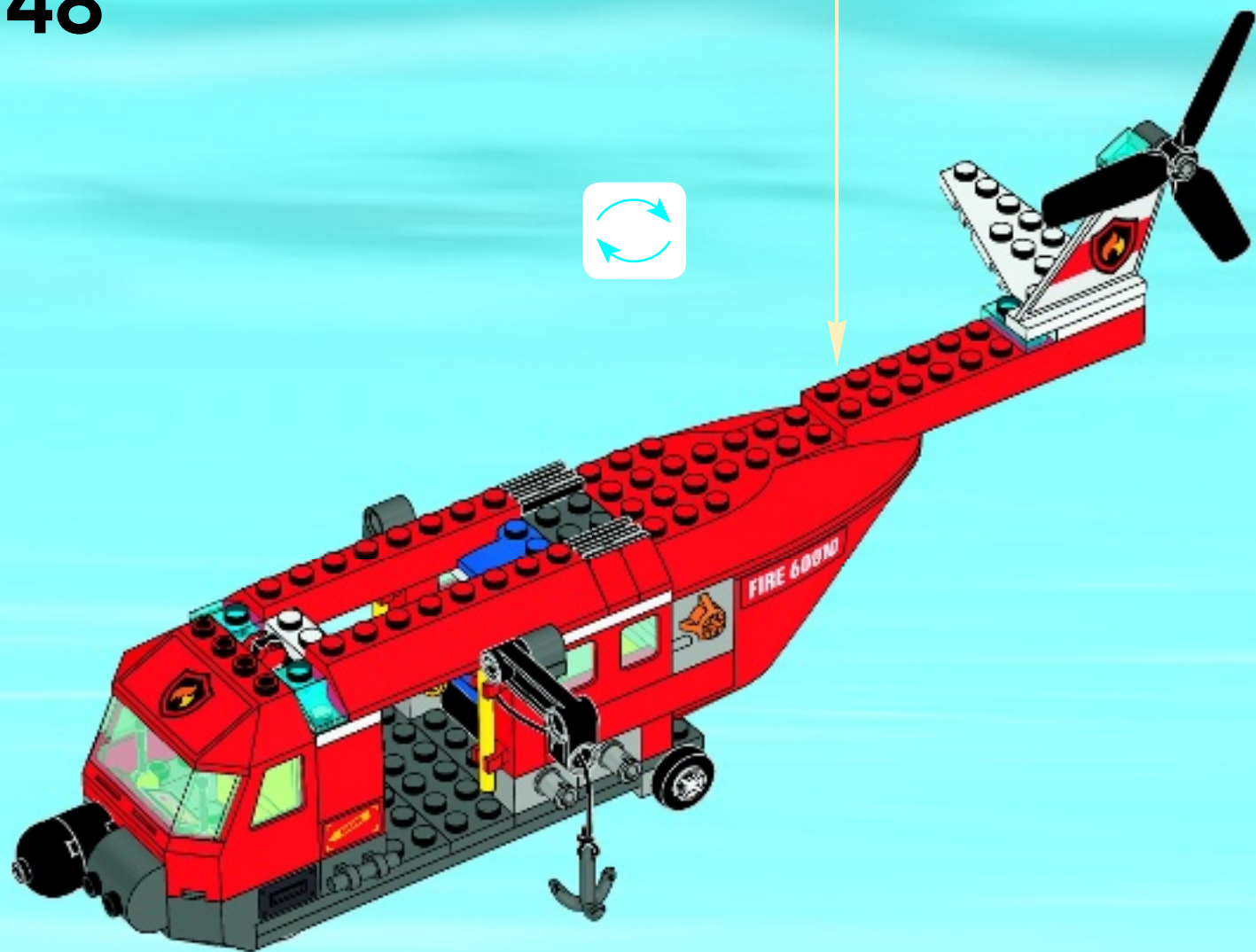



1x



1x

# 49

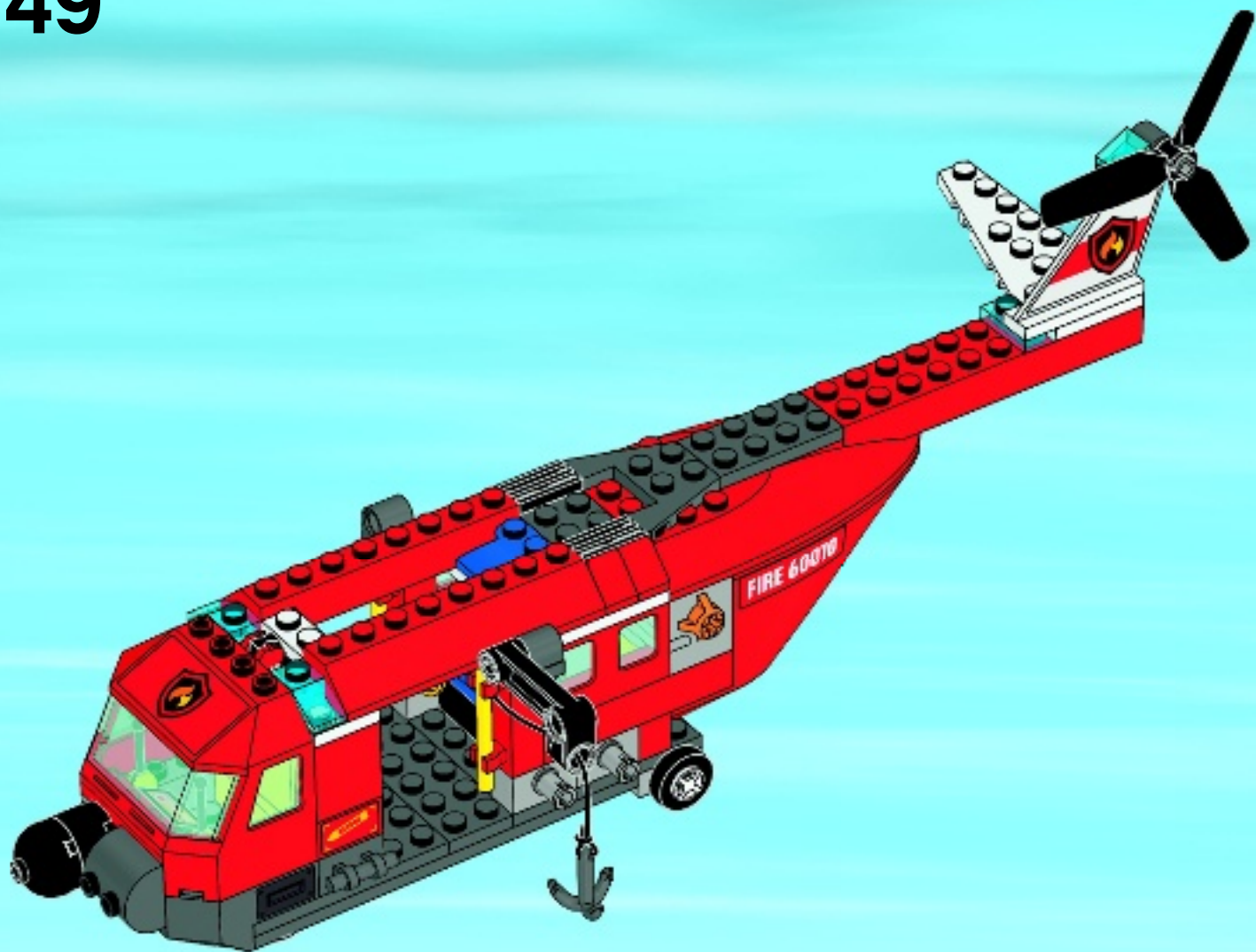



1x

# 50



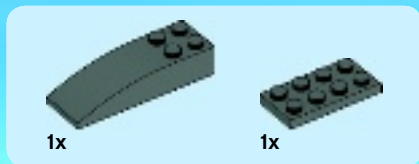

# 51

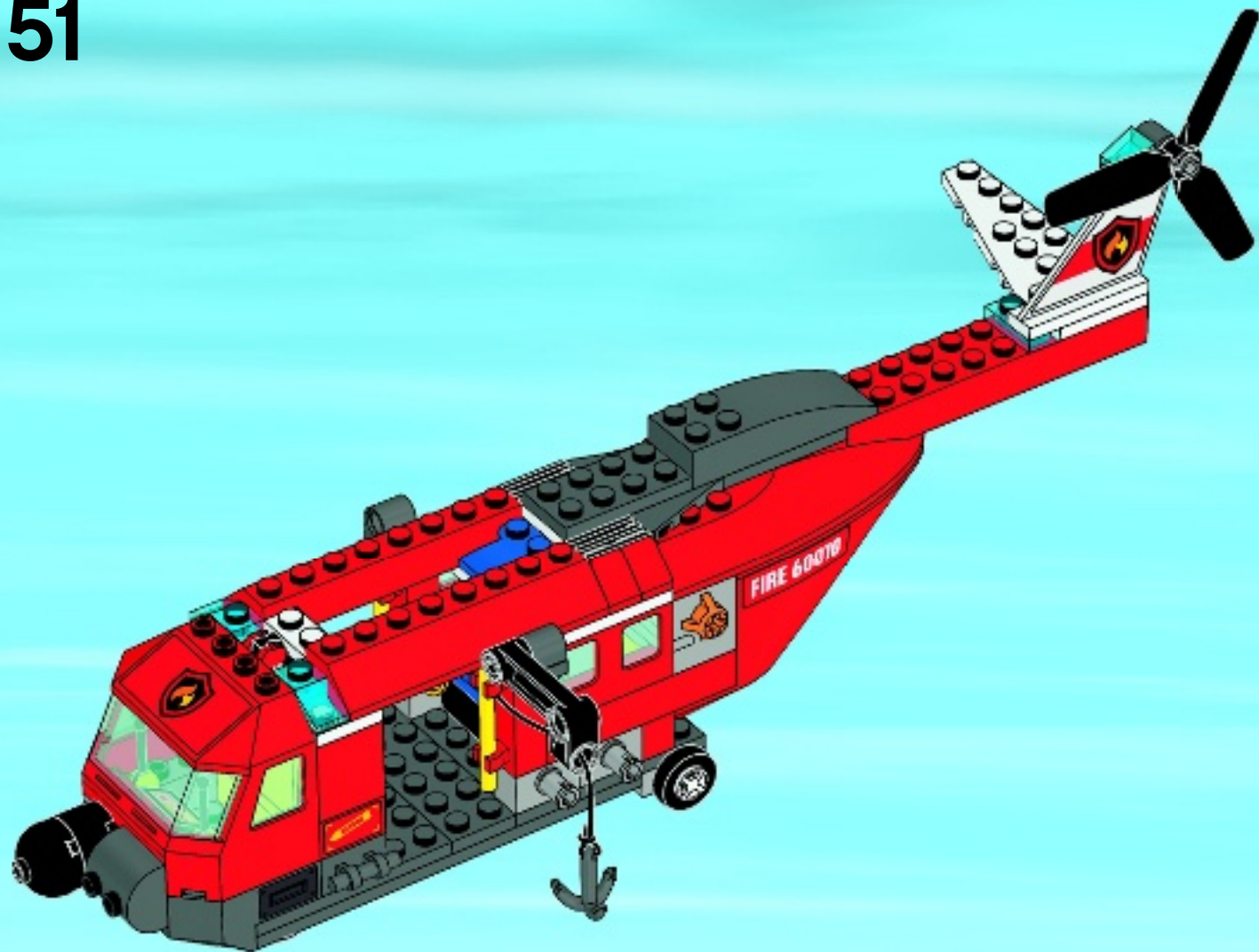



2x

52

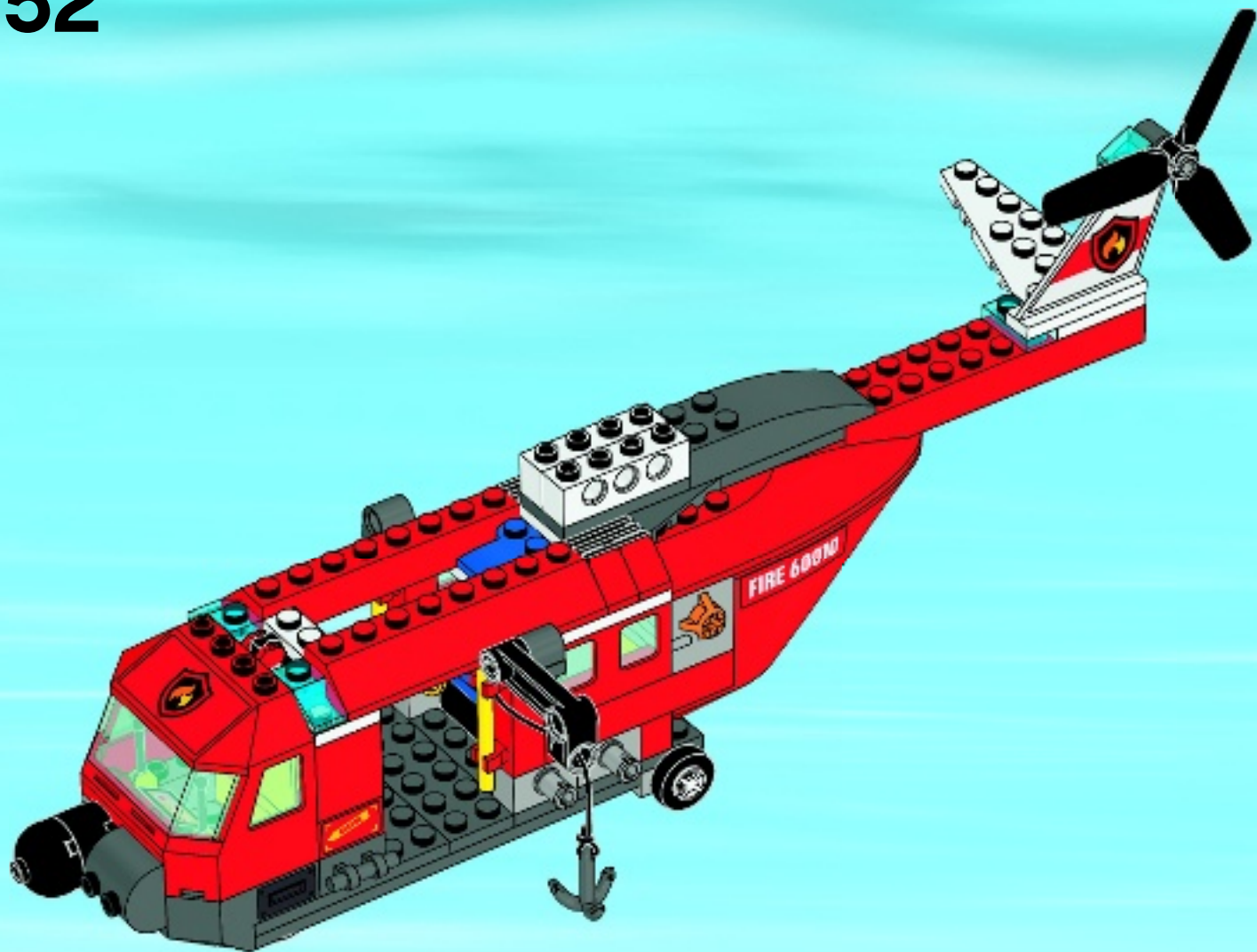



1x

# 53

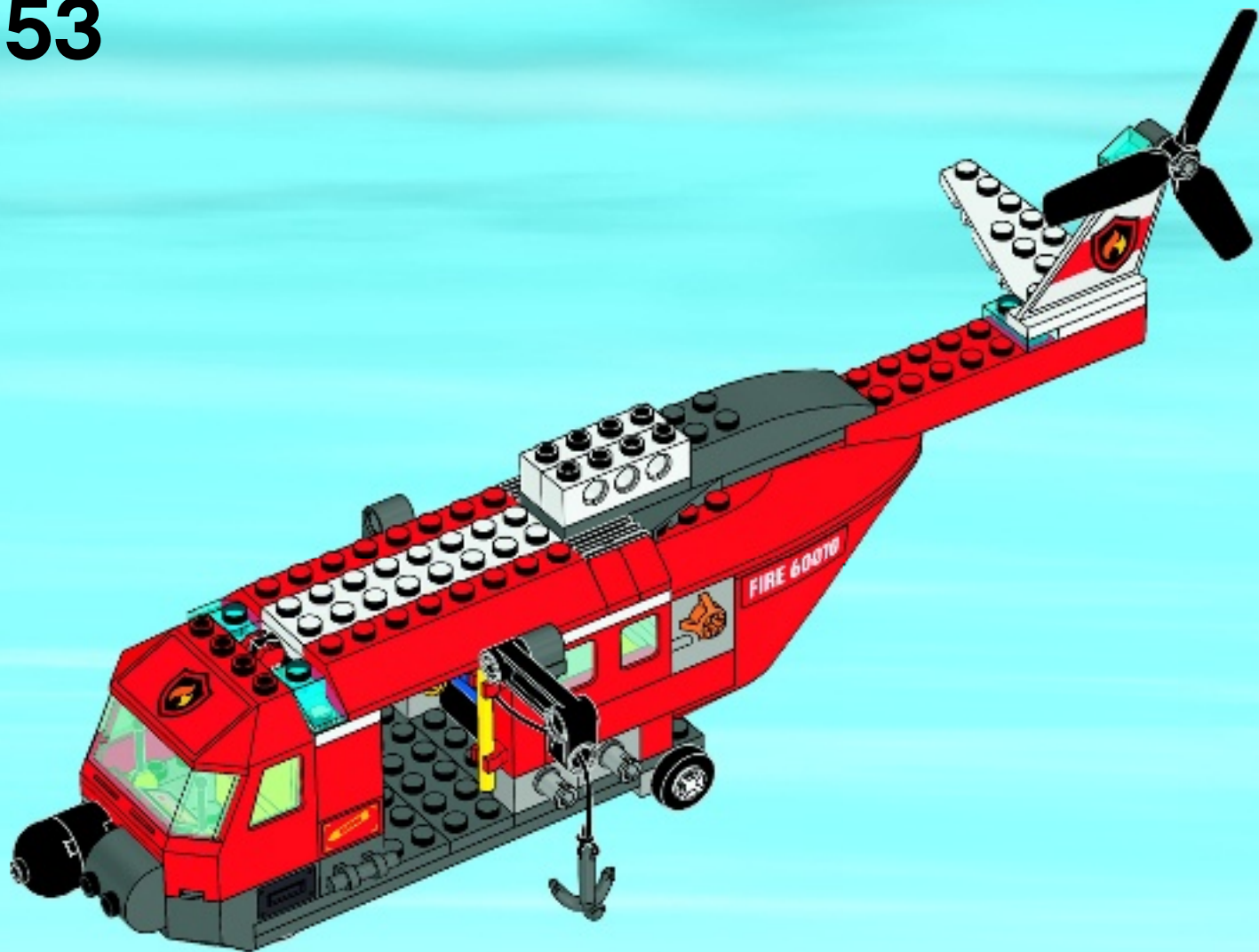



1x

# 54

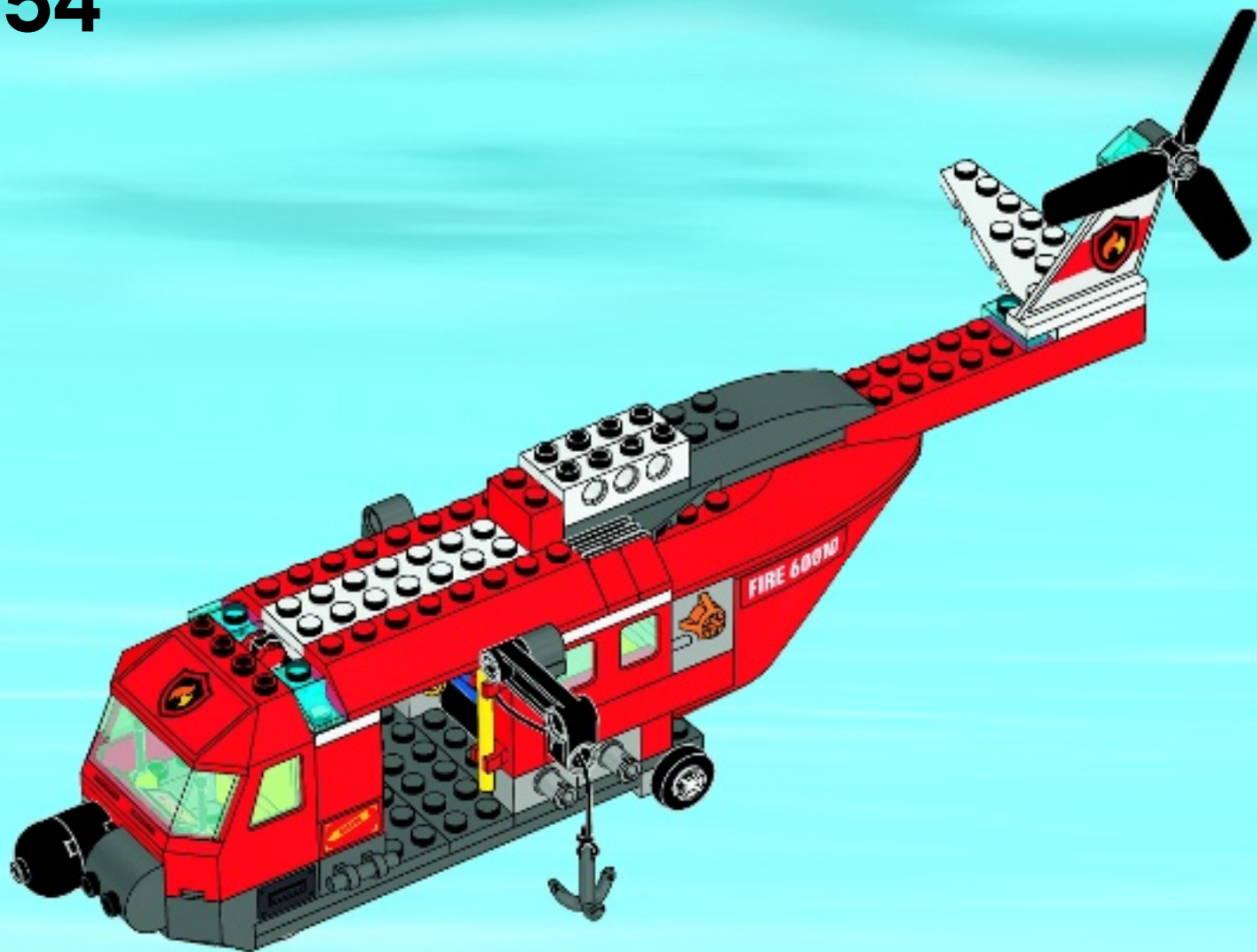





1x



1x

# 55

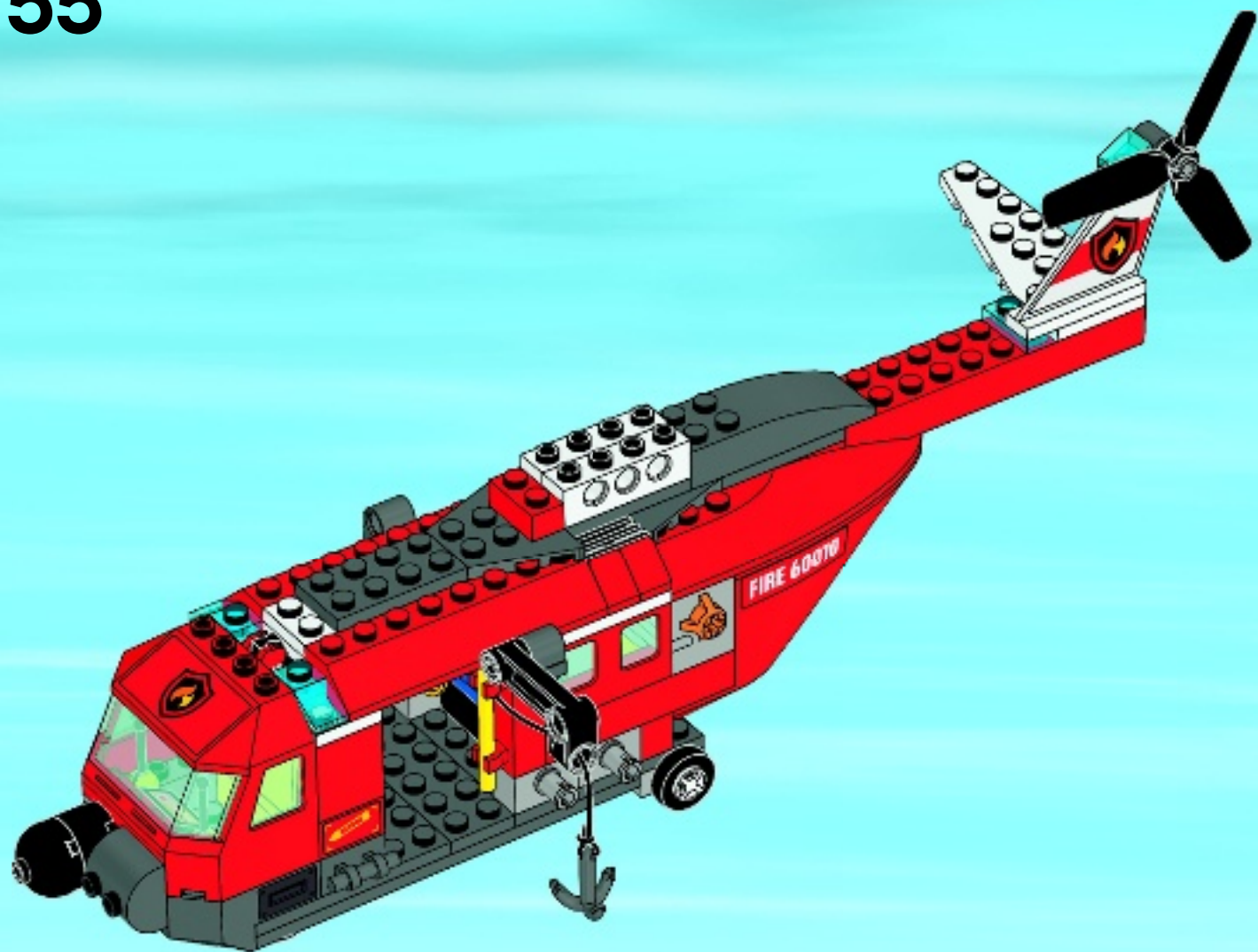



1x

# 56

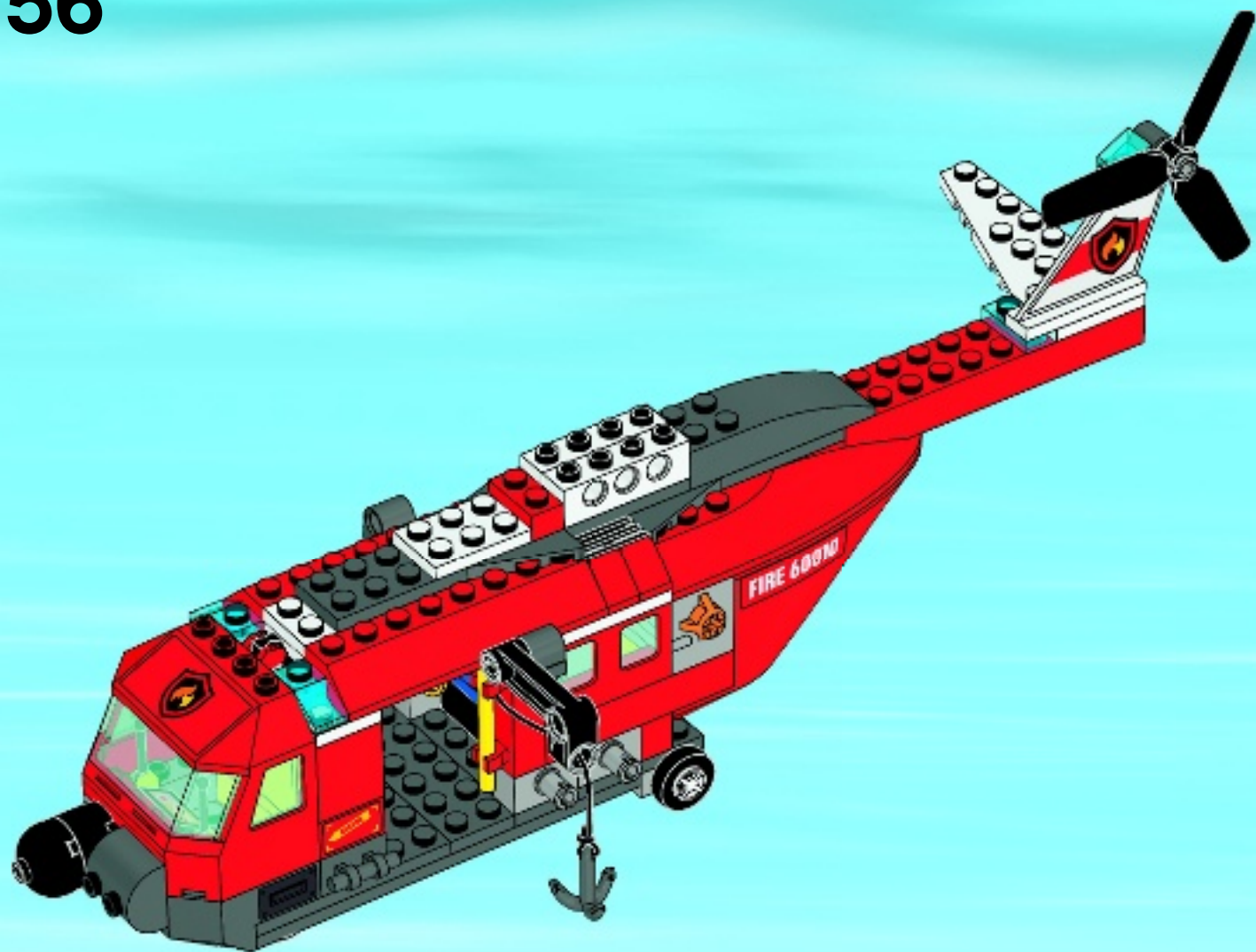



2x

57

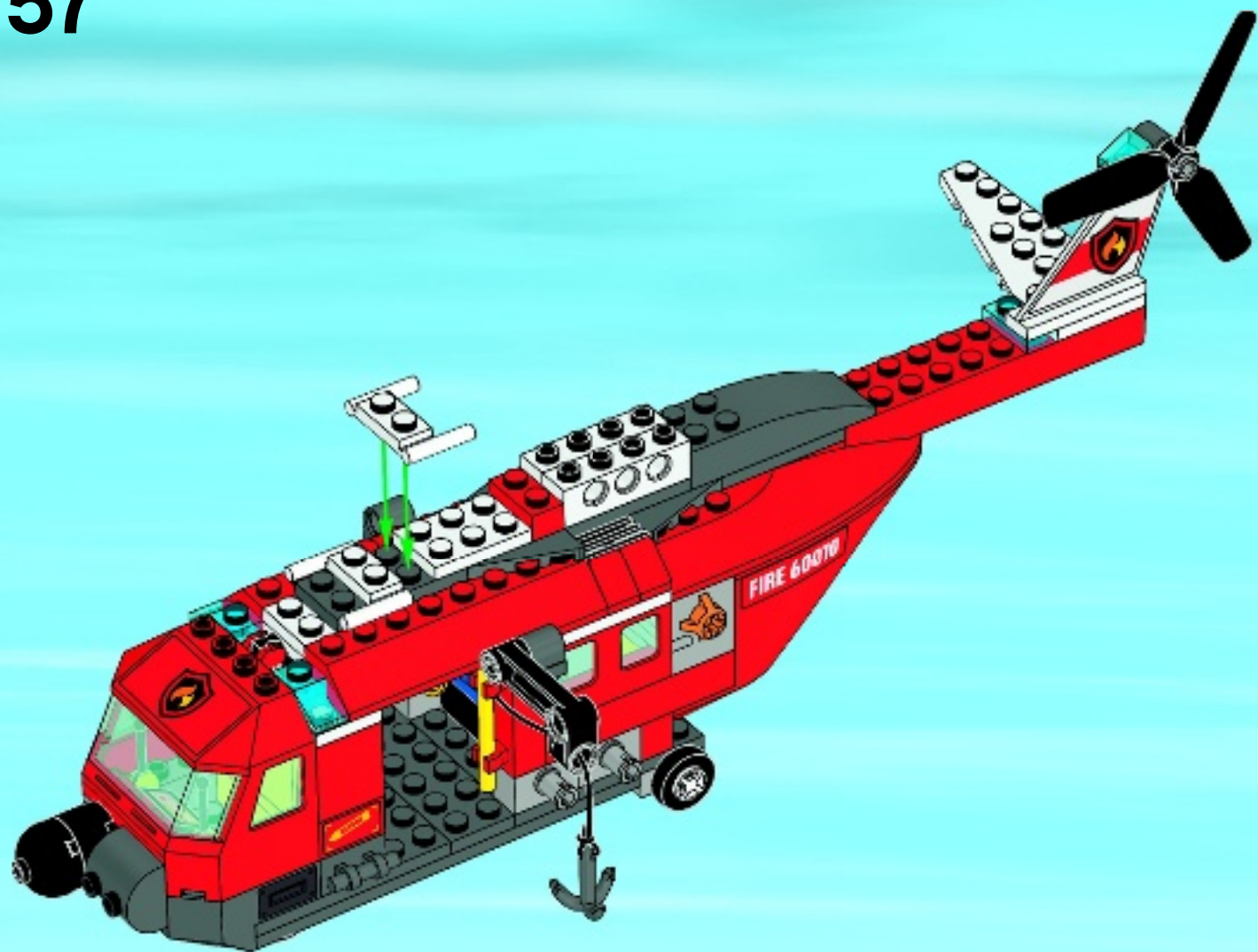



1x

# 58





1x

59





1x



1x

# 60

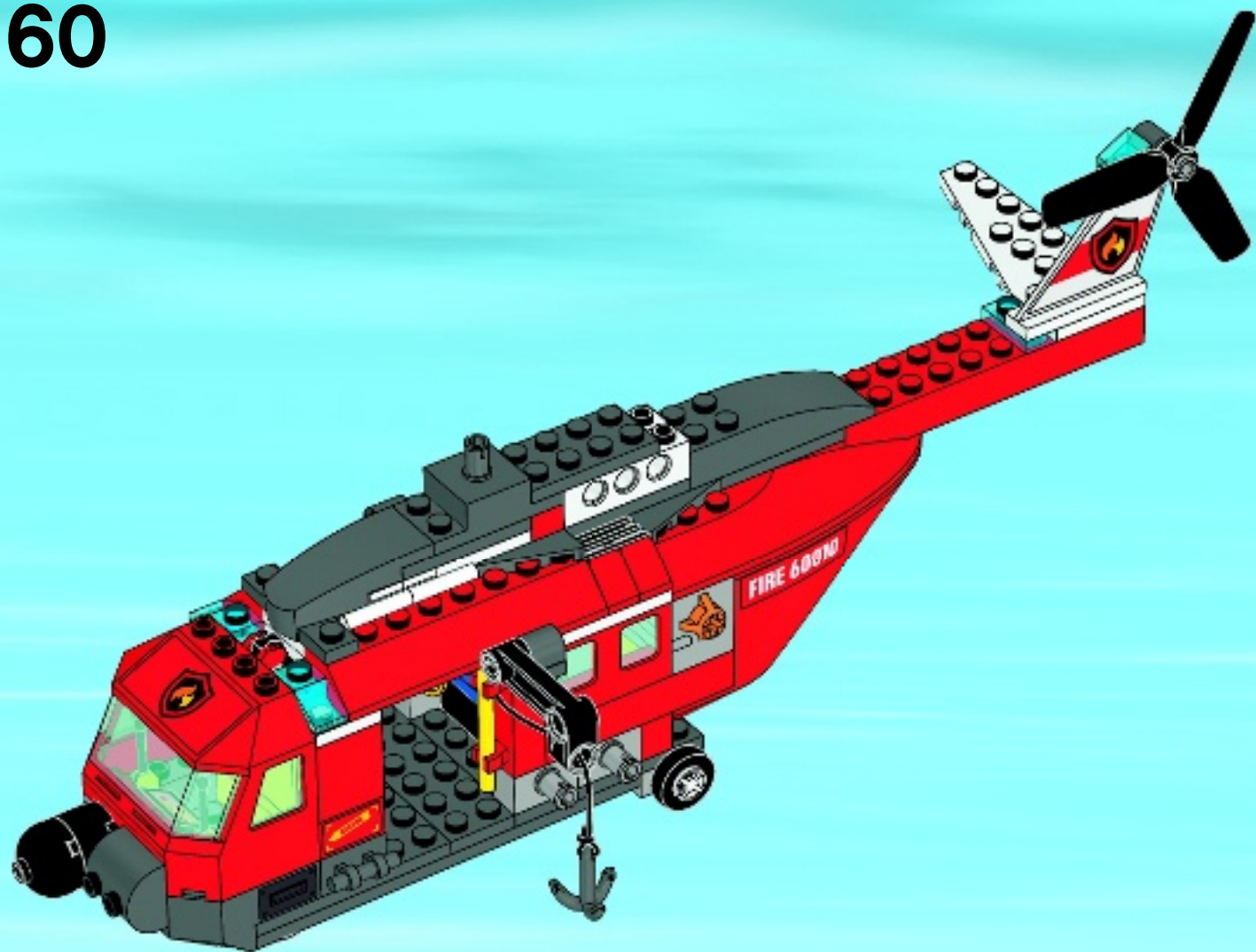



2x

# 61





1x



1x

# 62

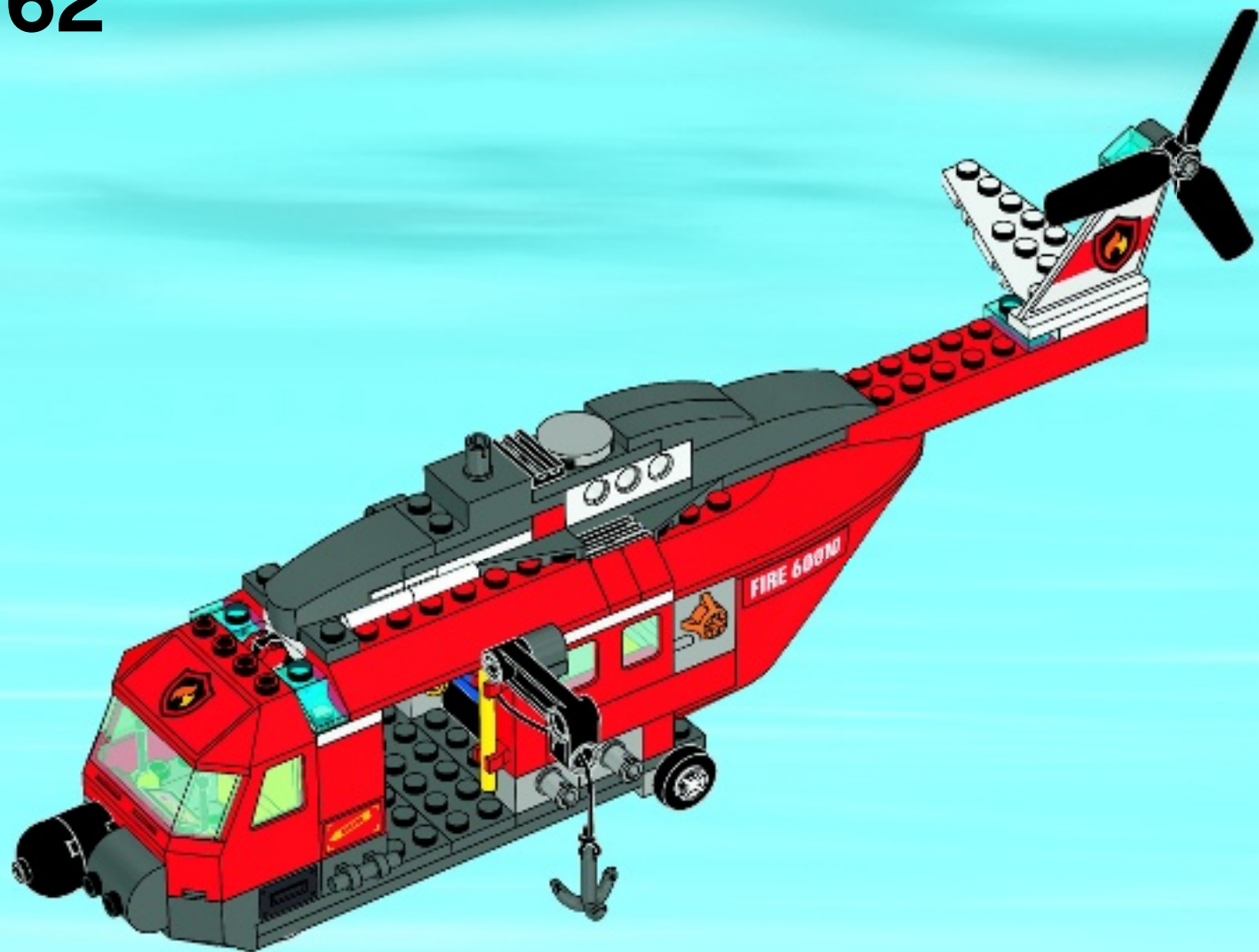



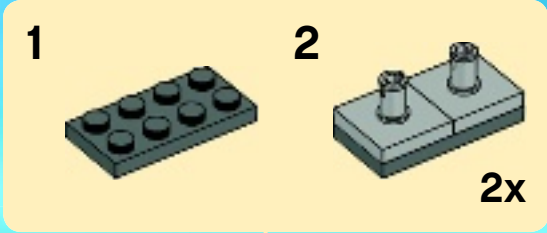

63

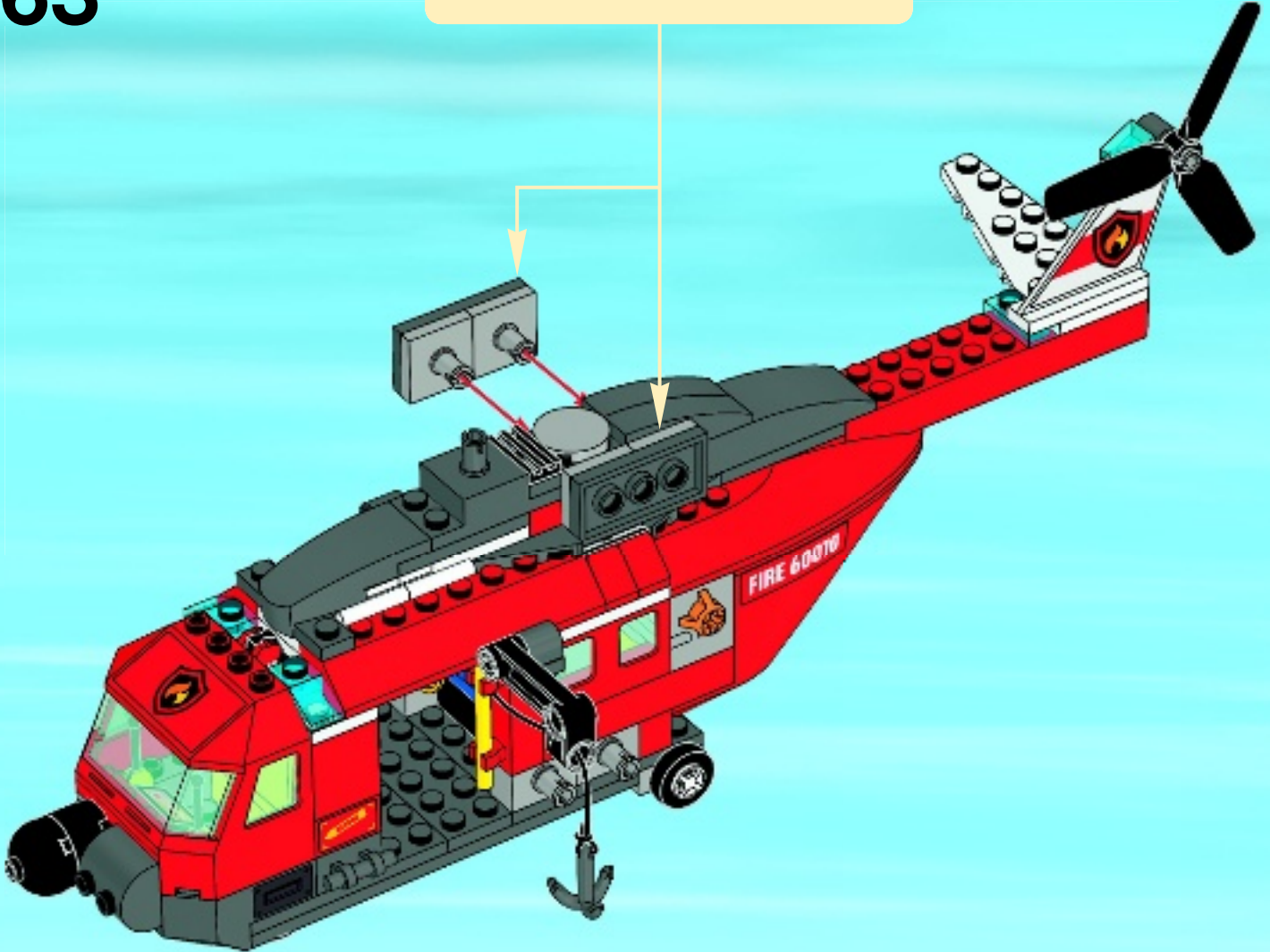

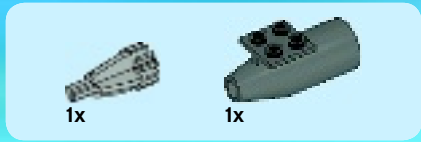

64

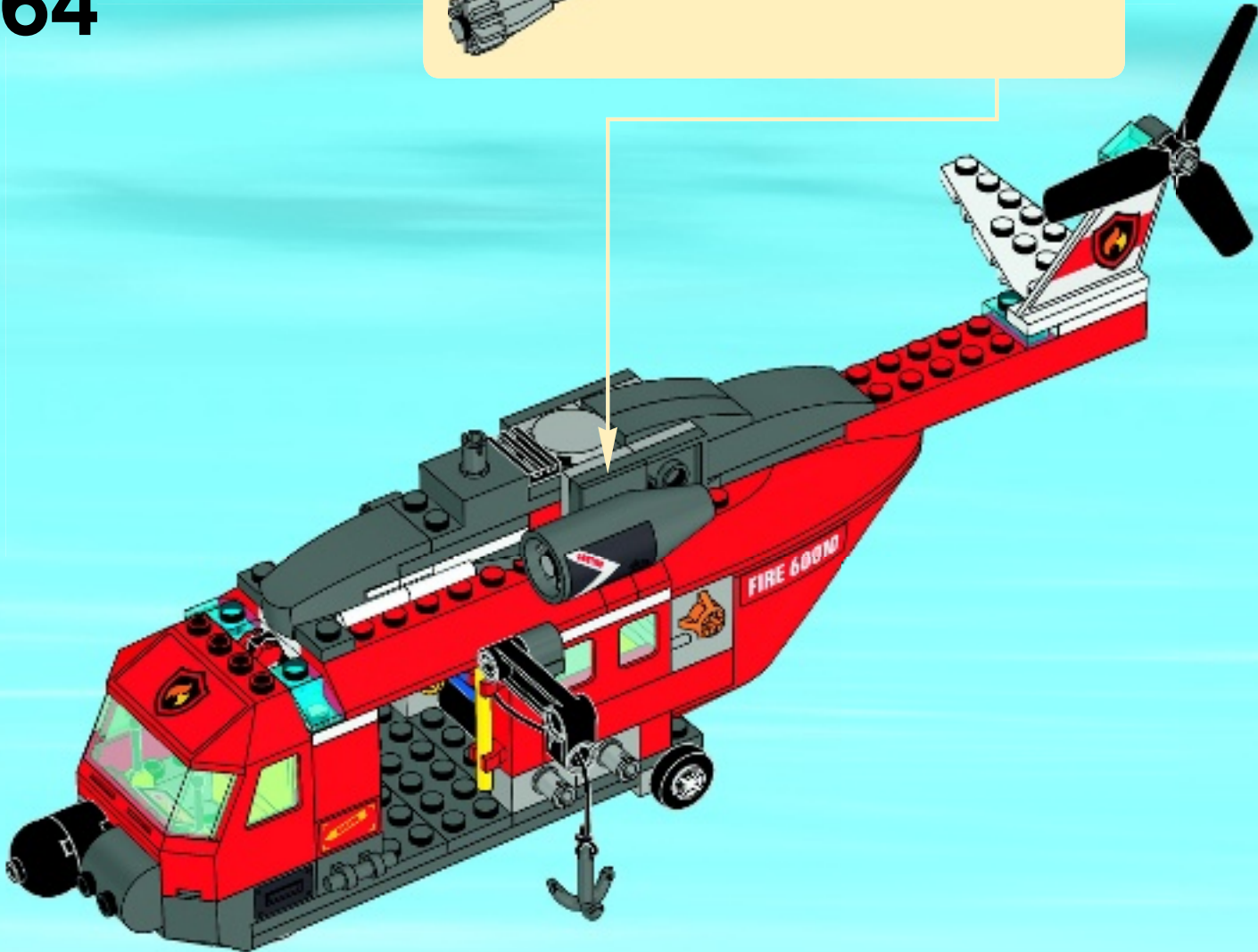
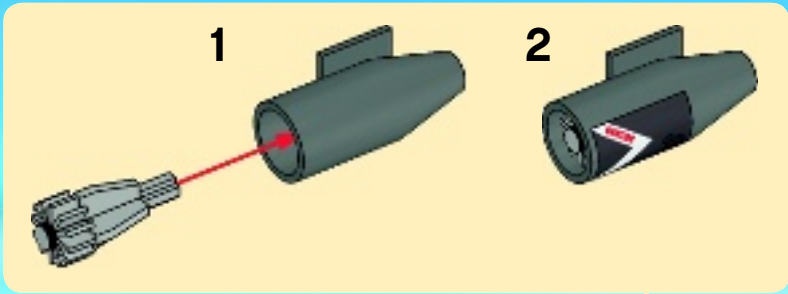



1x



1x

# 65



1

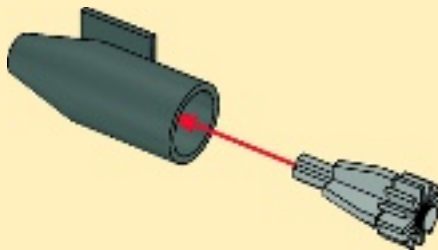

2

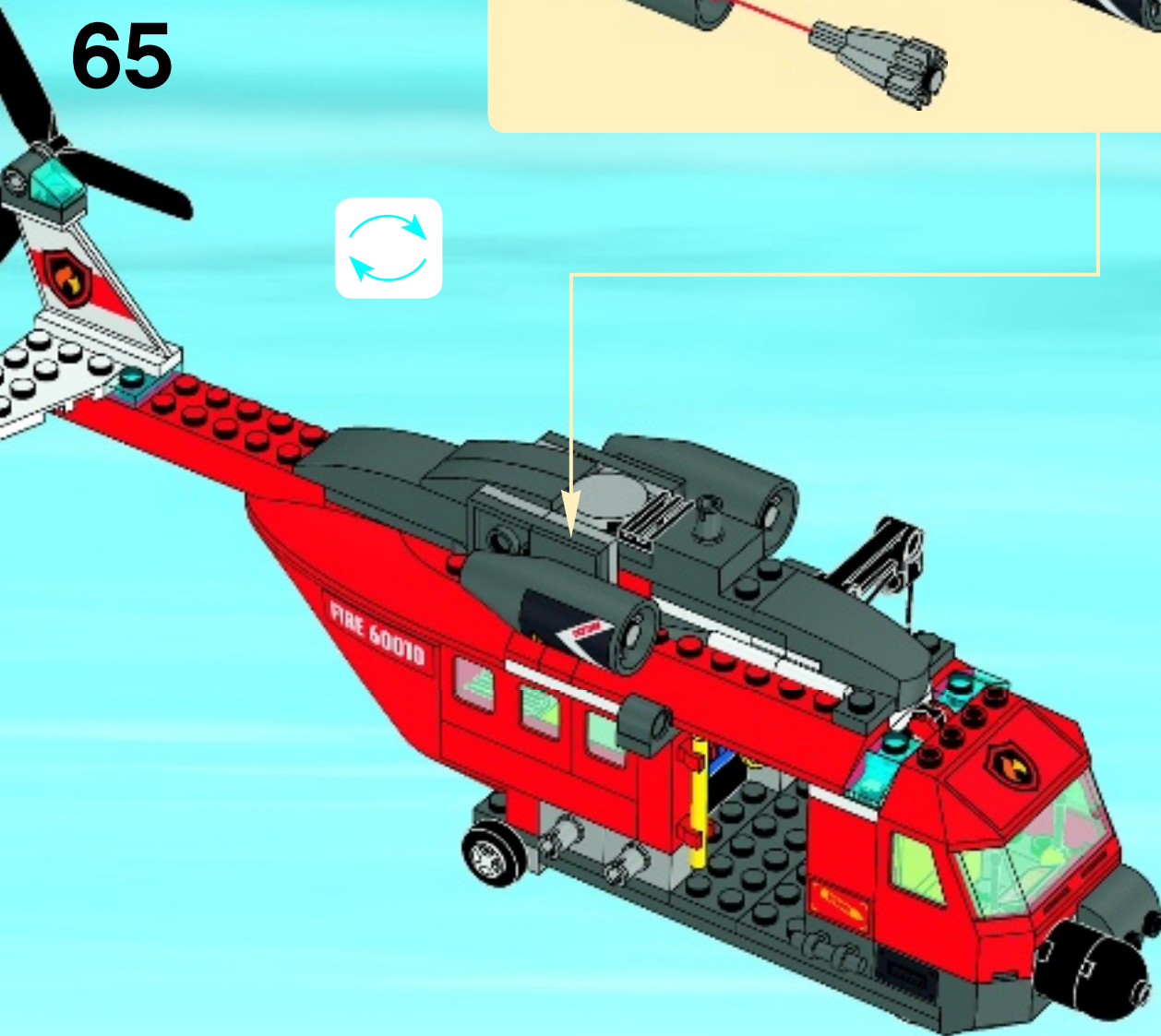



1x



1x

# 66

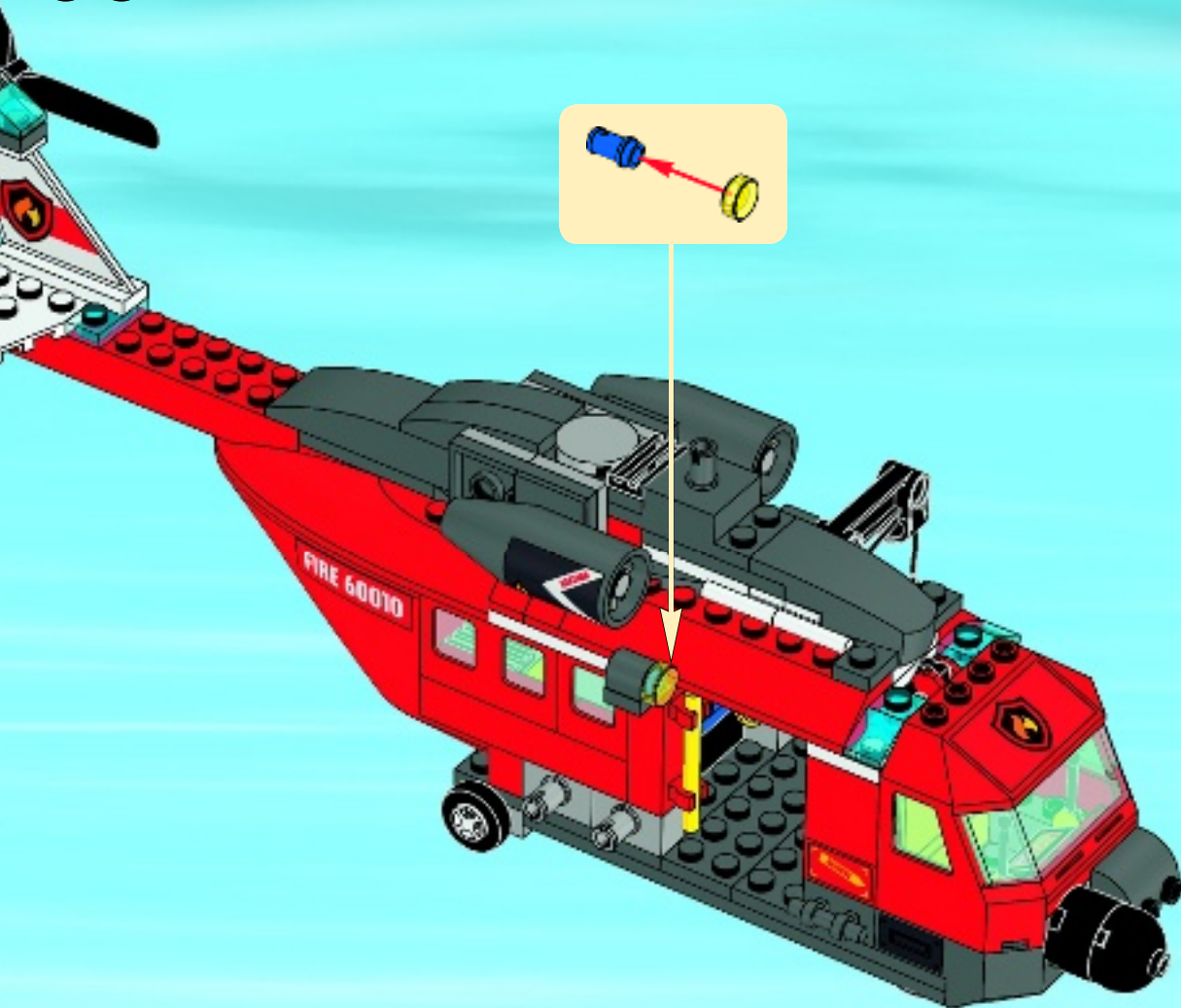



1x

1

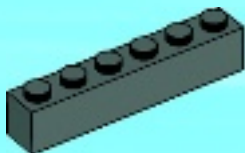

2x

2





1x

3

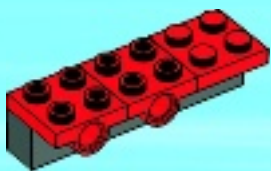

1x



2x

4

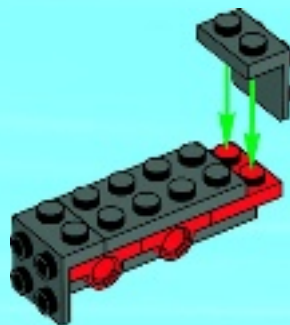



2x

5

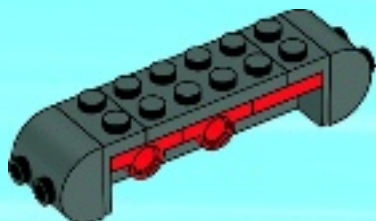

2x

6

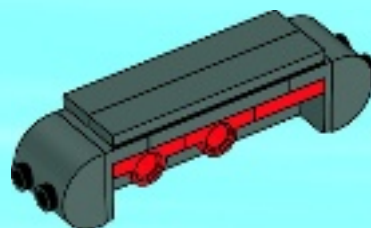

67





1x



1x



1x



1x



1x

# 68

1



2

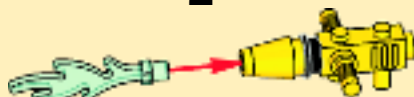

3

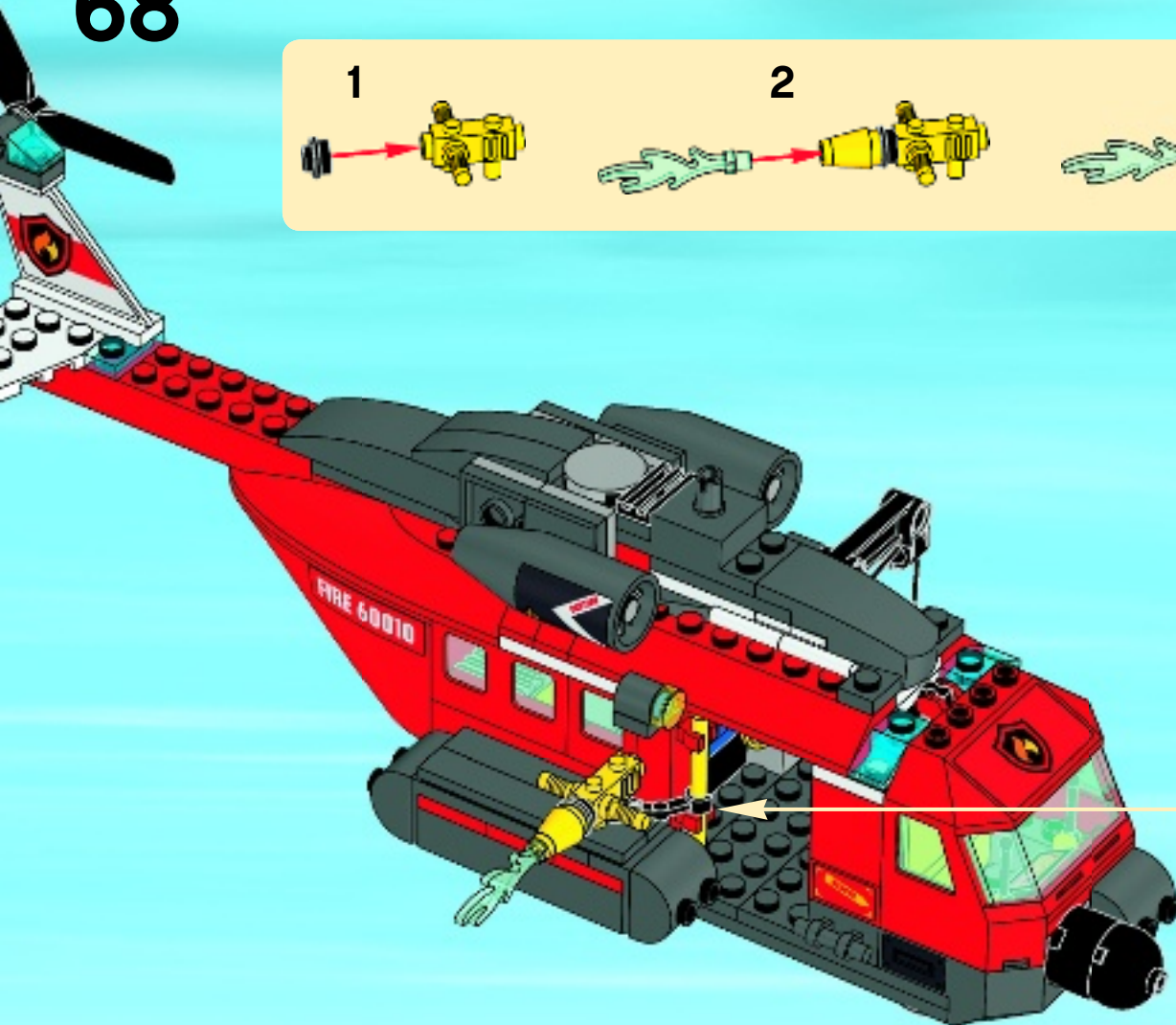



1x

1

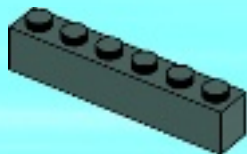

2x

2





1x

3



1x



2x

4

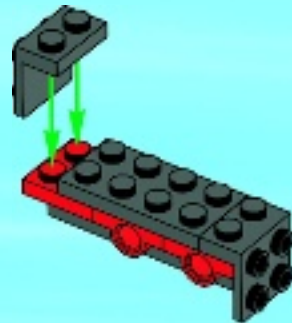



2x

5



2x

6

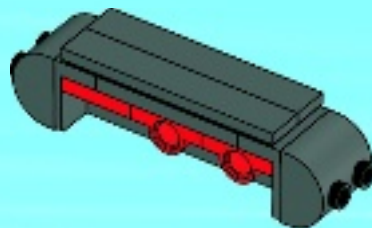

69



1x



1x



1x



1x



1x

# 70

1



2



3

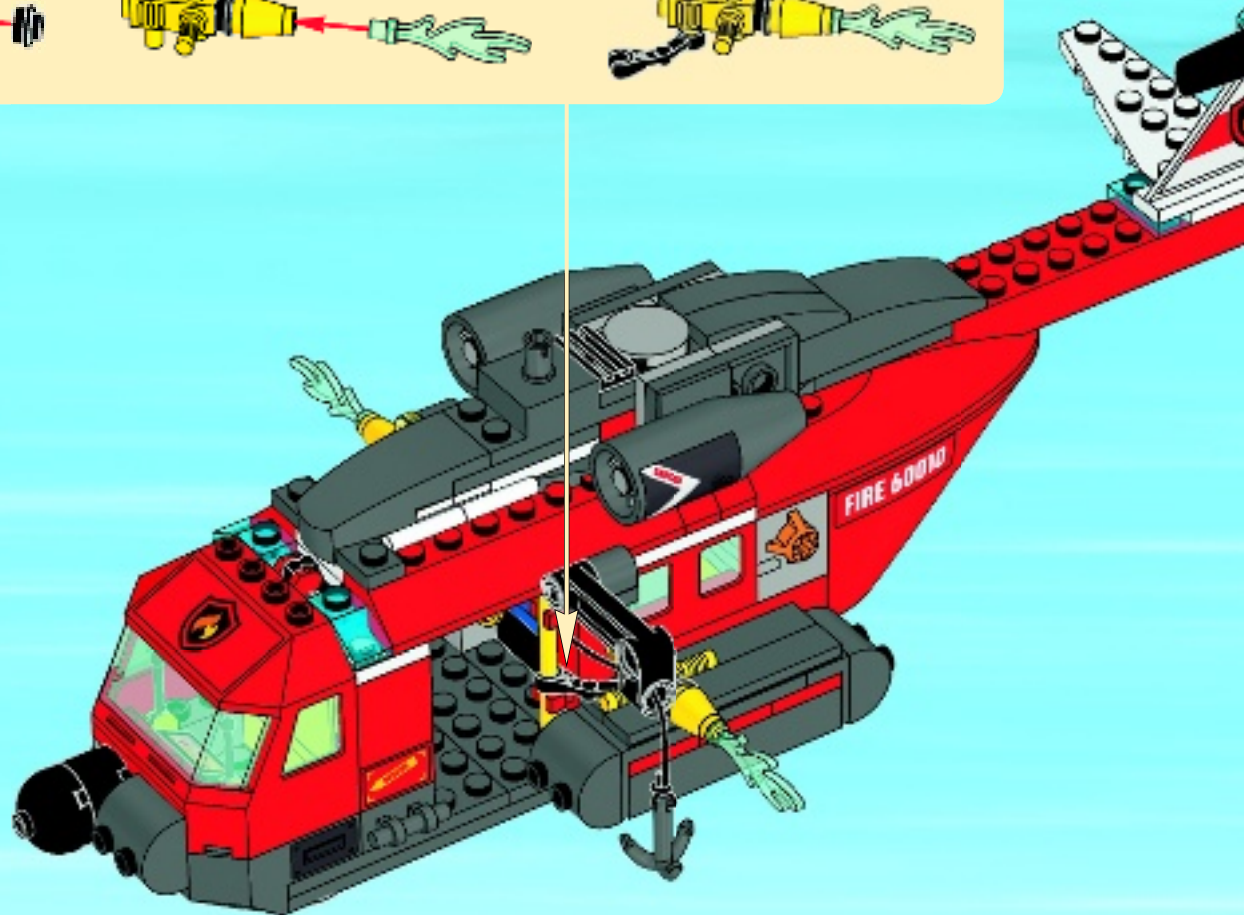



1



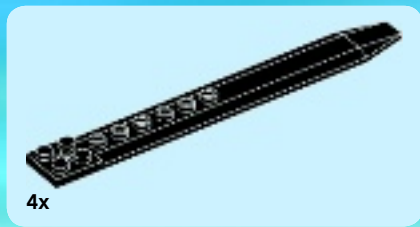

2

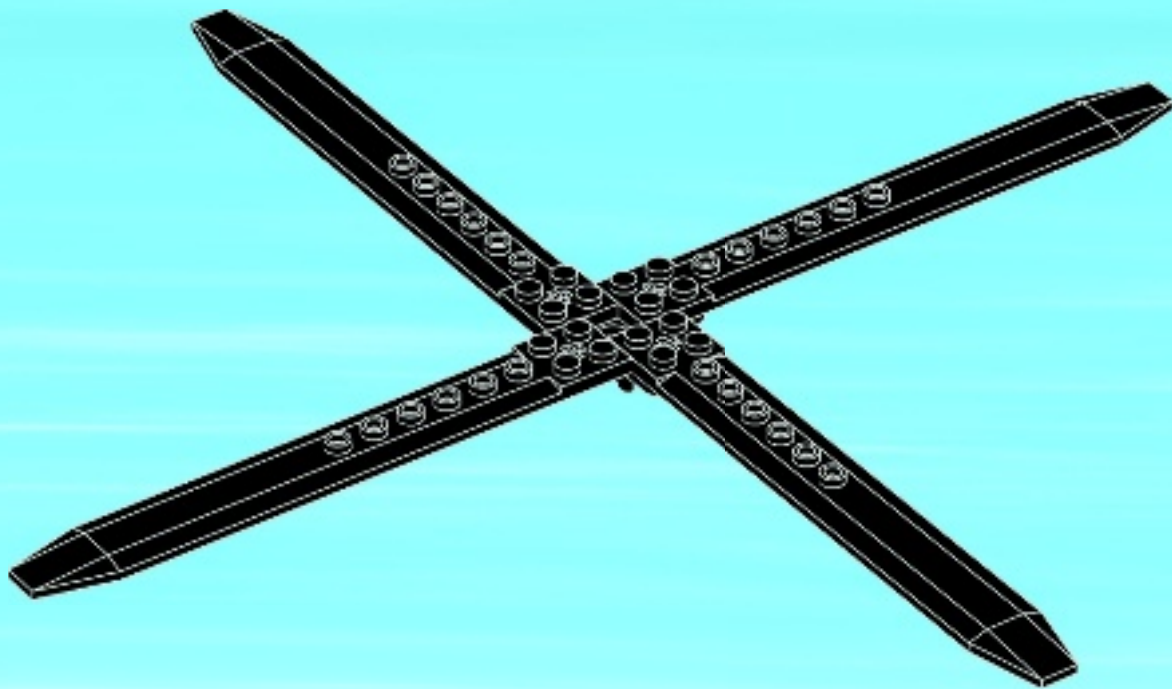
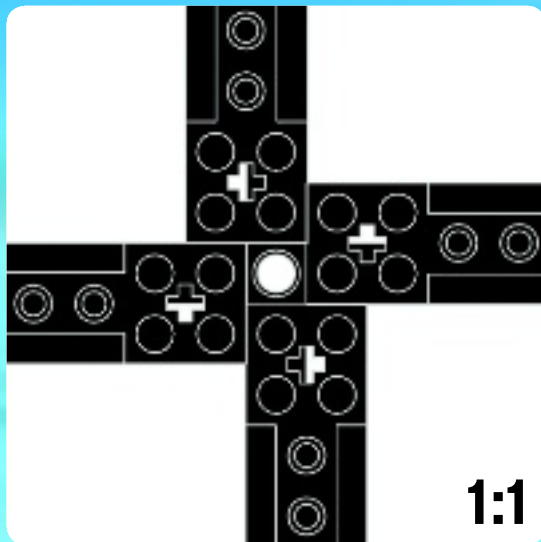





1x



1x

**3**

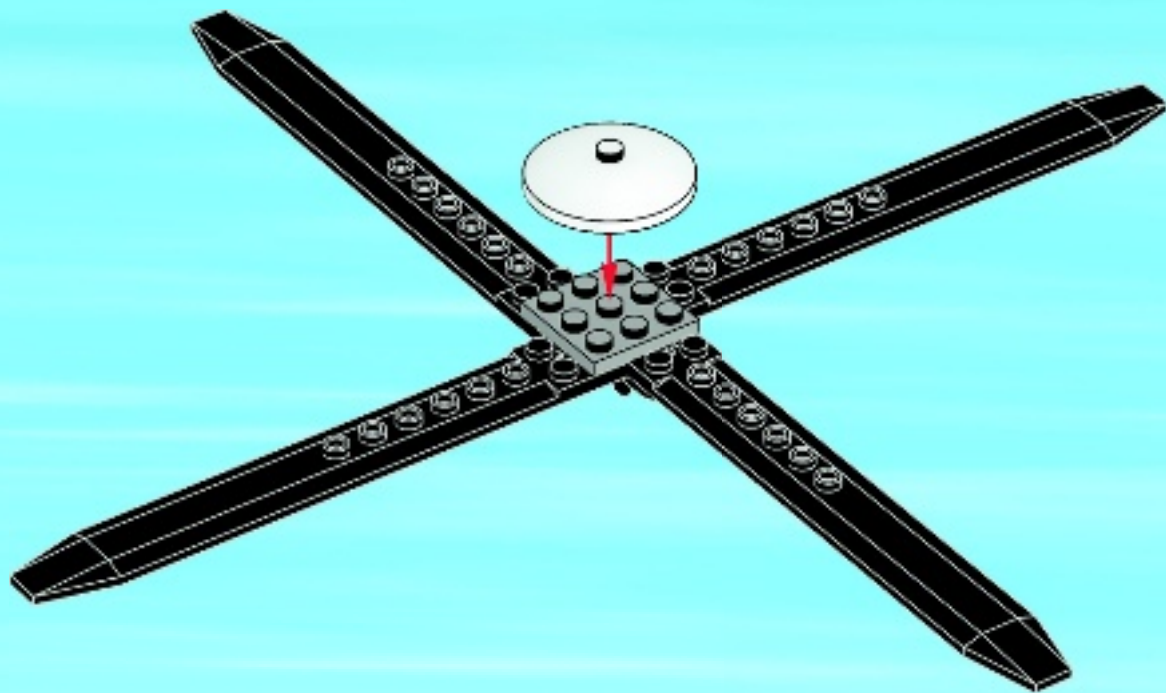

71

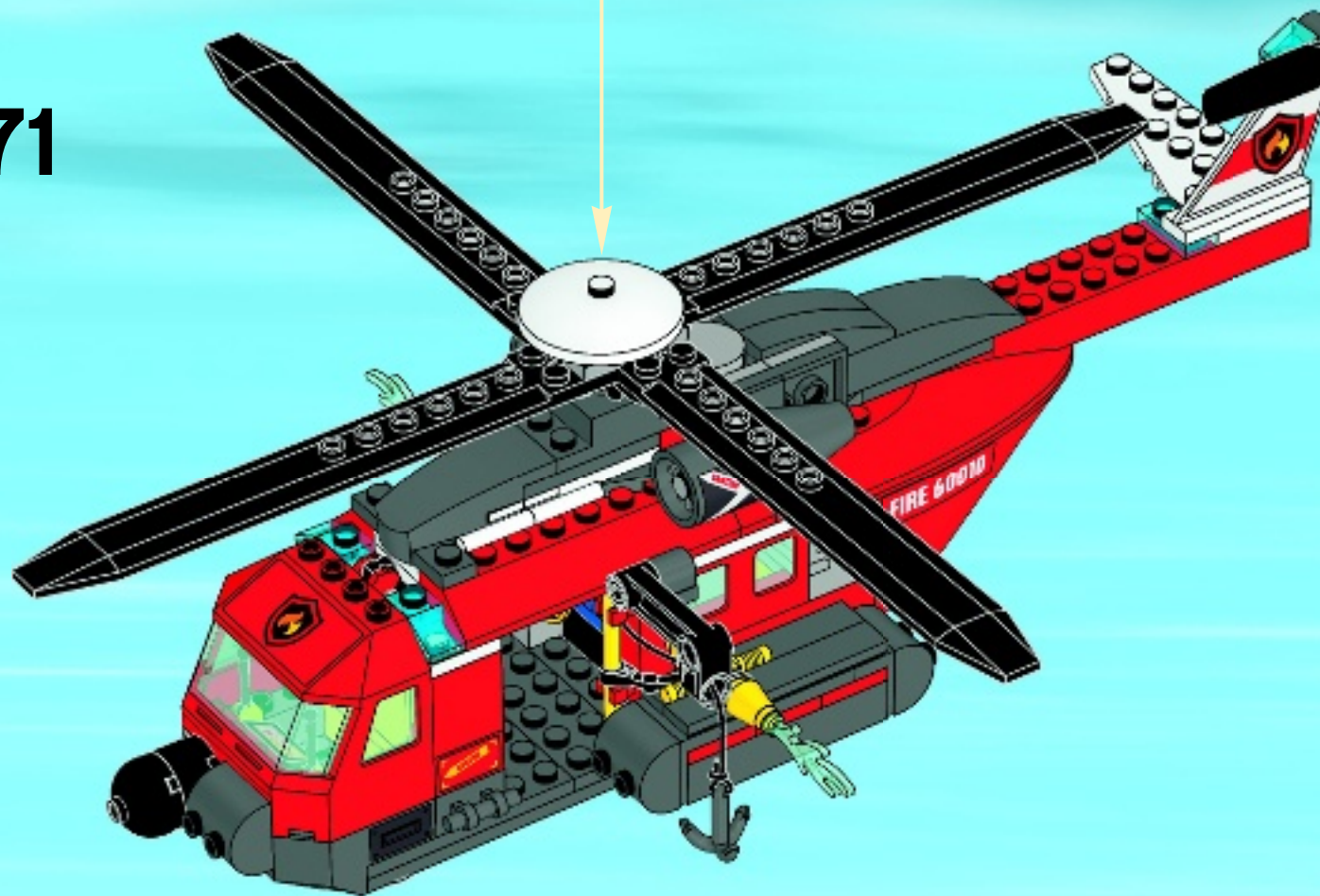

72

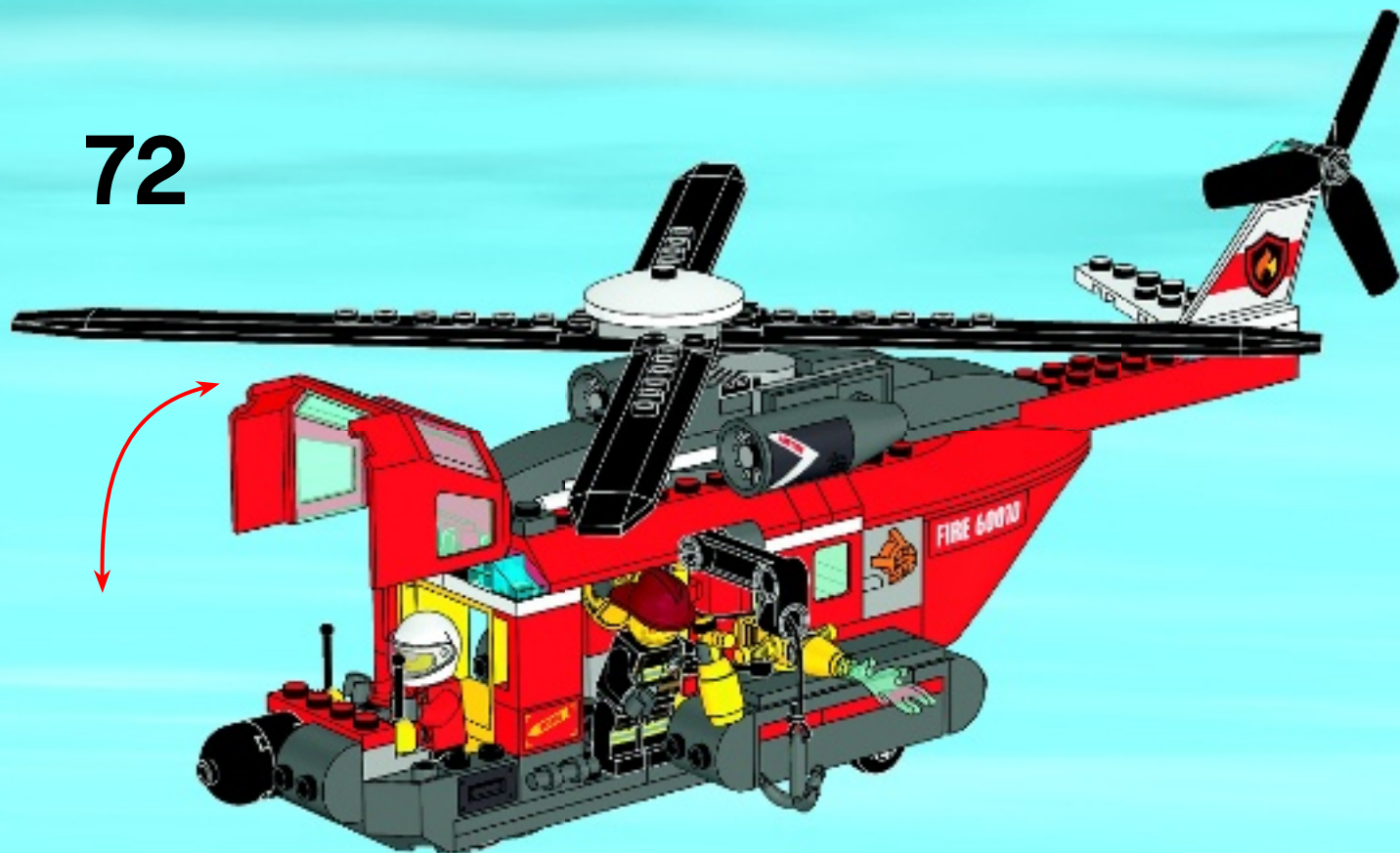

**LEGO** CITY



60004



60003



60002



60001



60000



CITY

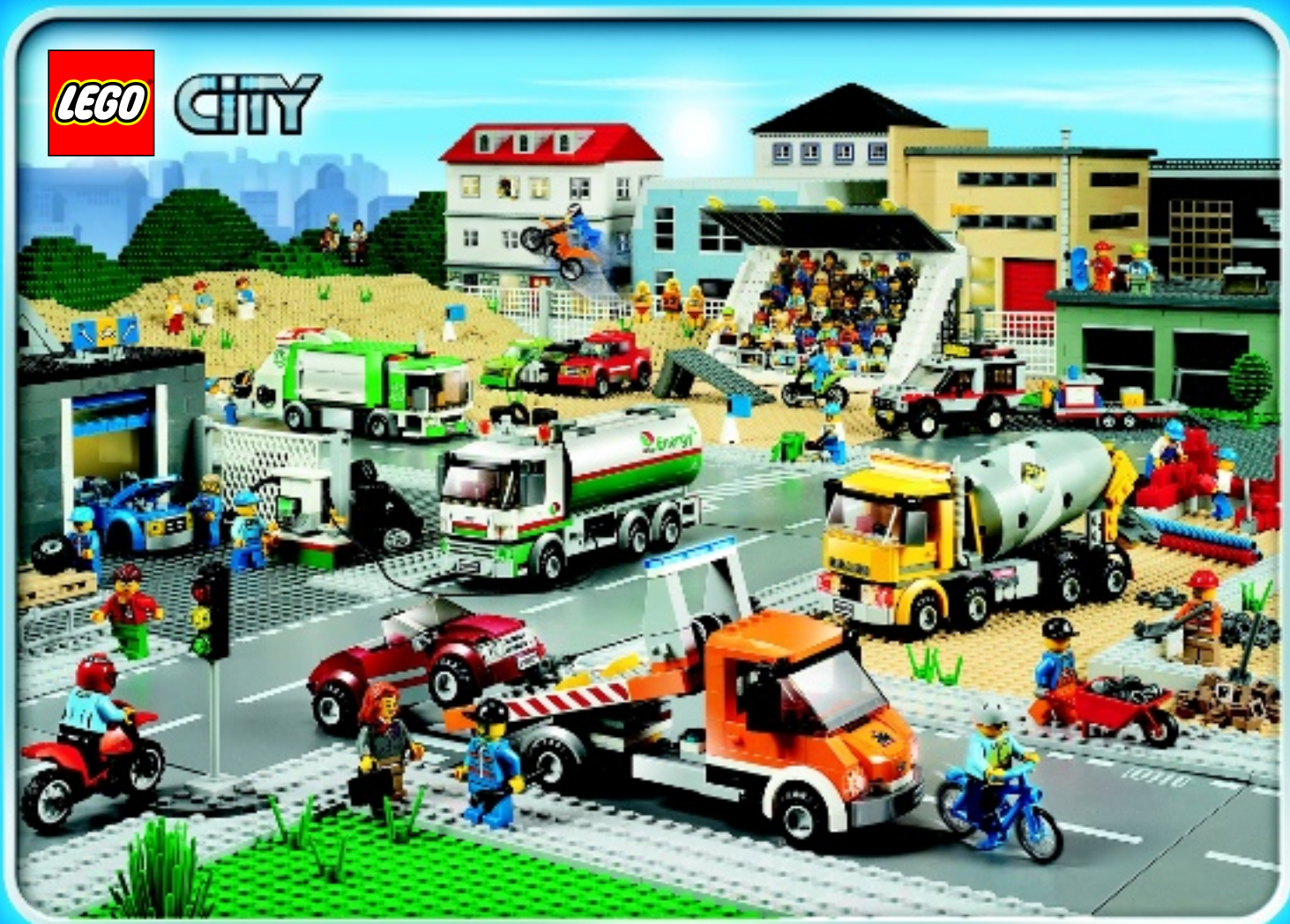

60016



60017



60018



4432



4433



2x  
614301



2x  
370101



2x  
302301



4x  
302101



1x  
303201



1x  
303401



2x  
383901



2x  
403201



1x  
4256097



2x  
396001



1x  
4298609



2x  
4549276



2x  
462401



1x  
234001



3x  
300421



3x  
300921



1x  
4617857



2x  
4563682



4x  
4603263



2x  
4550322



2x  
302221



2x  
403221



4x  
6014616



1x  
371021



2x  
4570470



1x  
4507686



2x  
4567872



1x  
6032091



1x  
4565426

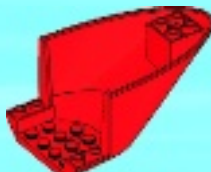

1x  
4652486



1x  
6025393



5x  
4496366



2x  
4143005



2x  
300124



1x  
306224



2x  
4525464



1x  
4520844



1x  
4256320



2x  
74156



2x  
4193511



1x  
4613418



1x  
6022320



2x  
4215263



1x  
4297401



2x  
300226



1x  
4216660



1x  
614326



1x  
4548180



4x  
241226



2x  
614126



2x  
4278359



1x  
4613759



2x  
6018684



1x  
6018492



2x  
4223247



2x  
4516843



1x  
4153044



1x  
302926



4x  
4527604



1x  
247926



1x  
4142731



1x  
4667463



1x  
4584350



1x  
6019986



1x  
4107783



1x  
4121715



2x  
403228



1x  
4497943



1x  
4163306



1x  
6056842

5x  
6023948

2x  
4155537

1x  
6025394

1x  
4260426

3x  
4244366

4x  
4266417

1x  
4650500

1x  
4650879

2x  
4261397

1x  
4211383

4x  
4211364

1x  
6030500

1x  
4211494

1x  
6015347

2x  
4560183

1x  
4166618

4x  
4211365

2x  
4654577

1x  
6052200

2x  
4278273

1x  
4657366

1x  
4211373

2x  
6018081

2x  
4211825

1x  
4211807

1x  
4239373

1x  
4211060

1x  
4211103

2x  
4211100

1x  
4211099

2x  
4211128

1x  
4211111

5x  
4211093

2x  
6042955

1x  
4210873

11x  
4211065

4x  
4210651

1x  
4211002

2x  
4211134

2x  
4211067

3x  
6019987

1x  
4210763

4x  
6048854

1x  
4211079

2x  
4596895

3x  
4256495

1x  
6005463

1x  
4652462

1x  
4581526

2x  
4579639

1x  
4560177

Customer Service  
Kundenservice  
Service Consommateurs  
Servicio Al Consumidor

LEGO.com/service or dial

🇪🇸 🇩🇪 🇫🇷 🇮🇹 🇯🇵 🇮🇸 🇩🇰 🇸🇪  
🇨🇦 🇩🇪 🇫🇷 🇮🇹 🇯🇵 🇮🇸 🇩🇰 🇸🇪  
: 00800 5346 5555  
: 1-800-422-5346

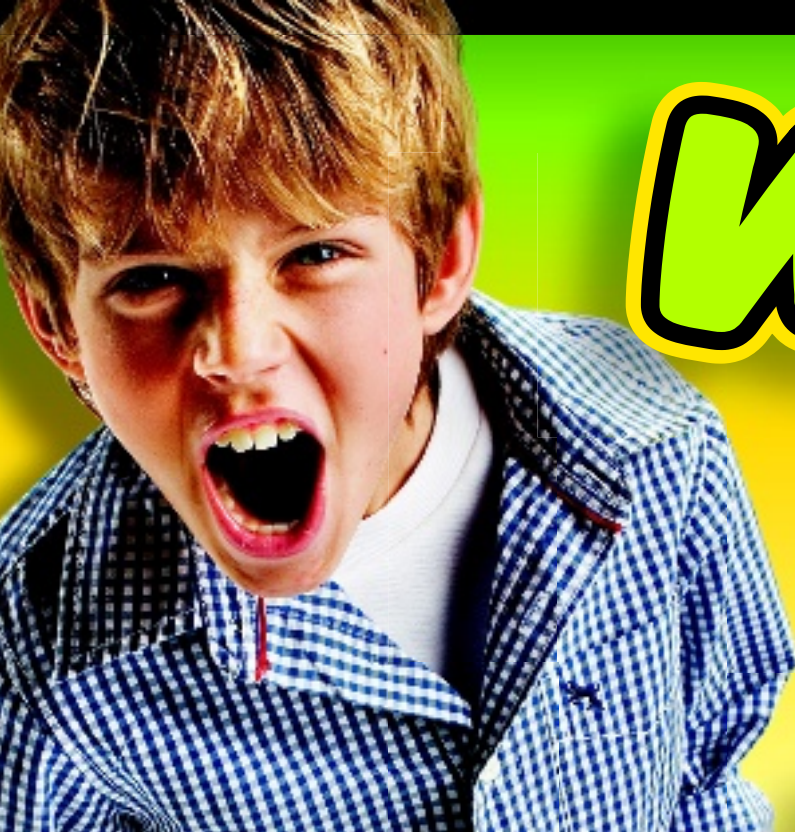

# WIN!

Go to [www.LEGOsurvey.com/product](http://www.LEGOsurvey.com/product)  
to fill out a survey for a chance  
to win a cool LEGO® Product.

No purchase necessary.

Open to all residents where not prohibited.



LEGO.com



## [www.LEGOsurvey.com/product](http://www.LEGOsurvey.com/product)

### GEWINNE! WIN!

Nimm an der Umfrage auf  
[www.LEGOsurvey.com/product](http://www.LEGOsurvey.com/product)  
teil und hab die Chance ein cooles  
LEGO® Produkt zu gewinnen!

Die Teilnahme am Gewinnspiel führt zu keinerlei  
Kaufverpflichtungen. Teilnahme in allen nicht  
ausgeschlossenen Ländern möglich.

Ga naar [www.LEGOsurvey.com/product](http://www.LEGOsurvey.com/product),  
vul een  
enquêteformulier in en maak  
kans op een cool LEGO® product.

Geen aankoopverplichting.  
Iedereen mag deelnemen, uitgezonderd  
ingezetenden van landen waar een  
enquêteverbod geldt.

### GAGNE! 当てよう!

Visite [www.LEGOsurvey.com/product](http://www.LEGOsurvey.com/product)  
pour répondre à un  
questionnaire et avoir une chance de  
gagner un produit LEGO® très cool!

Aucune obligation d'achat.  
Ouvert à tous les résidents des pays  
autorisés.

[www.LEGOsurvey.com/product](http://www.LEGOsurvey.com/product) にアクセスして、  
アンケートにご記入ください。当選者にはレゴ®  
製品を差し上げます。

お買い上げの必要はありません

禁止されていない限り、すべての皆様にご利用いただけます。