



CITY

60005



WARNING: CHOKING HAZARD.
Small parts. Not for children under 3 years.

1



2



3



4





⚠️ AVERTISSEMENT :
RISQUE
D'ÉTOUFFEMENT.
Contient des petites pièces.
Ne convient pas aux enfants
de moins de 3 ans.

⚠️ ADVERTENCIA:
PELIGRO DE ASFIXIA.
No recomendado para
niños menores de 3 años.
Contiene piezas pequeñas.





4x

1

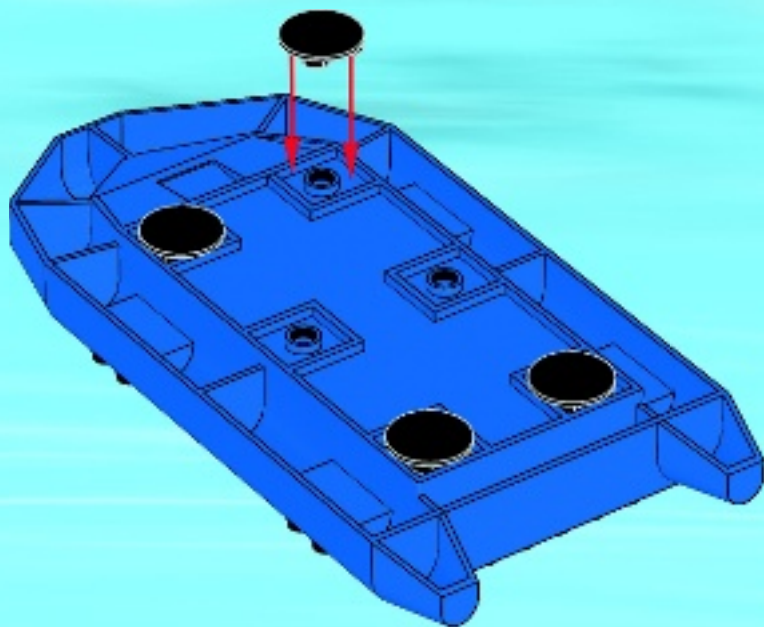



1x

2

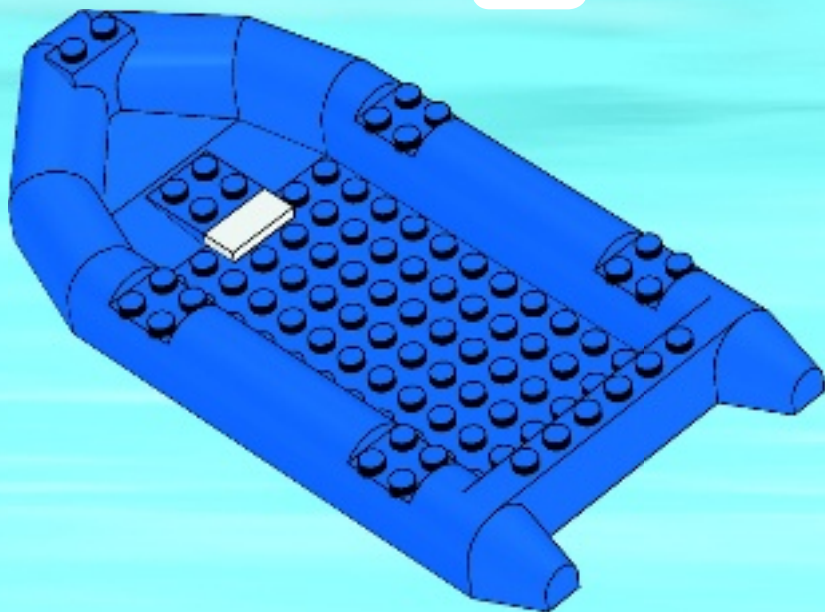



1x

3

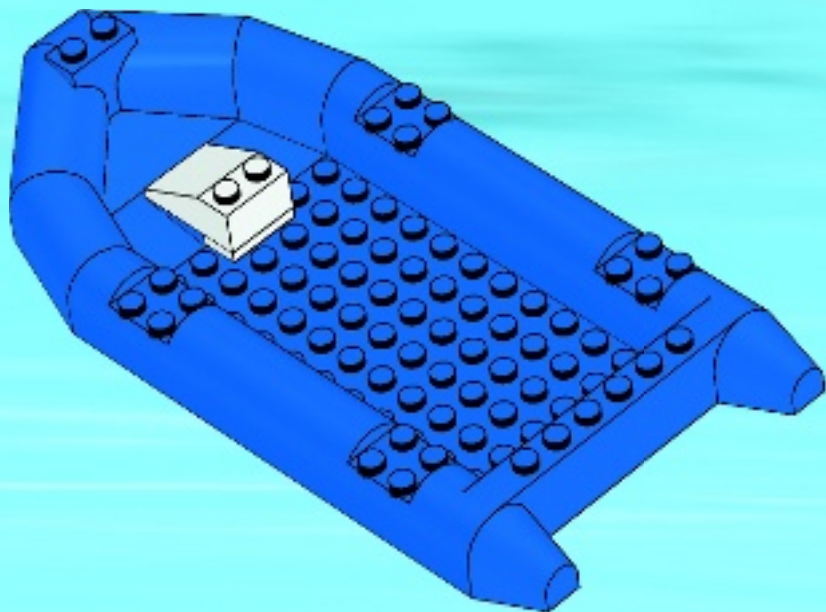



2x



2x

4

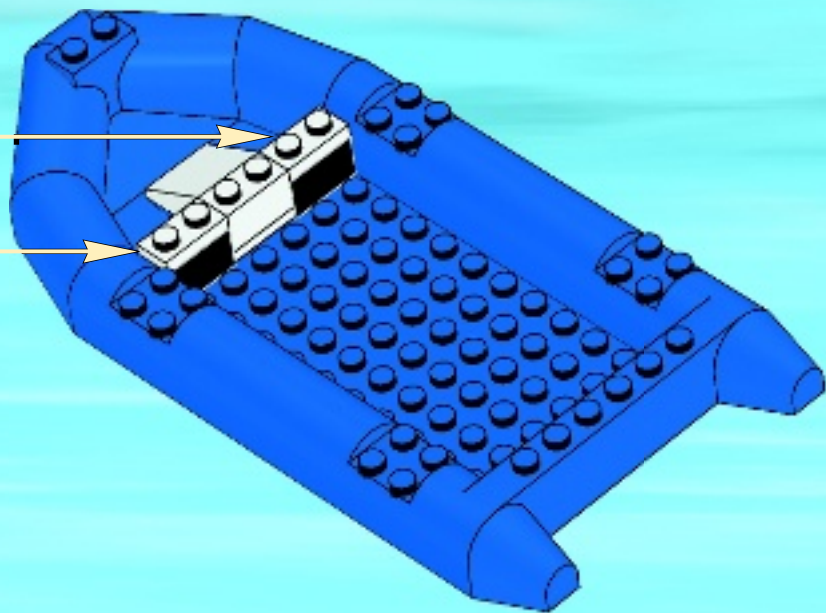
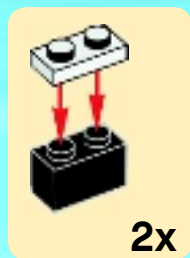



1x



1x

5

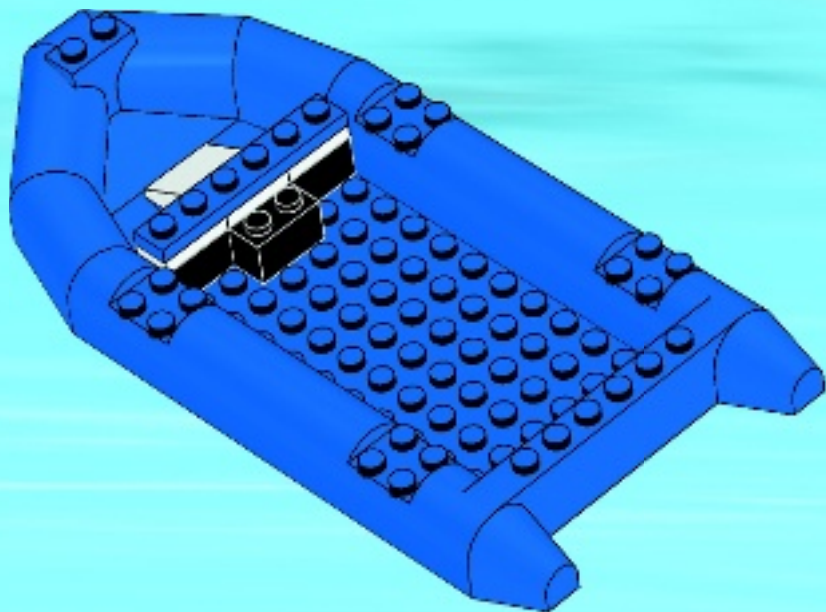



1x

6

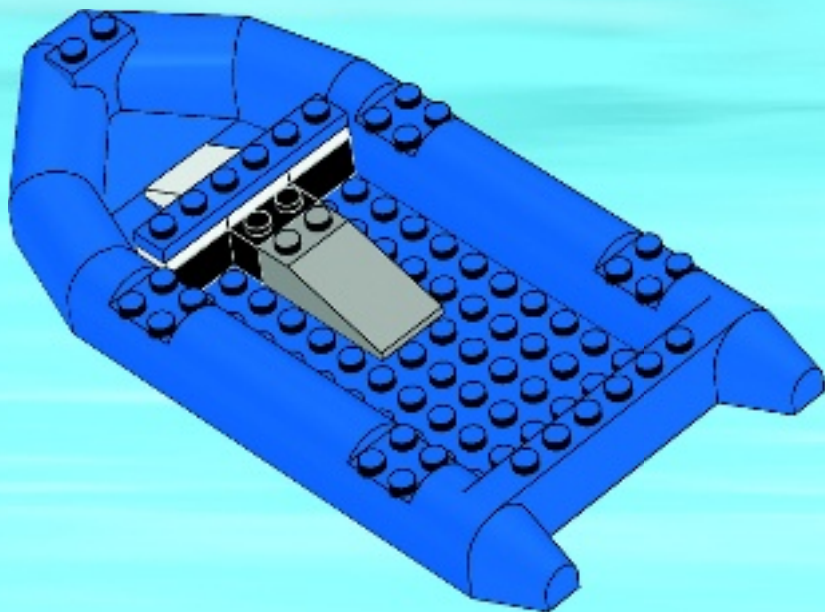



1x

7

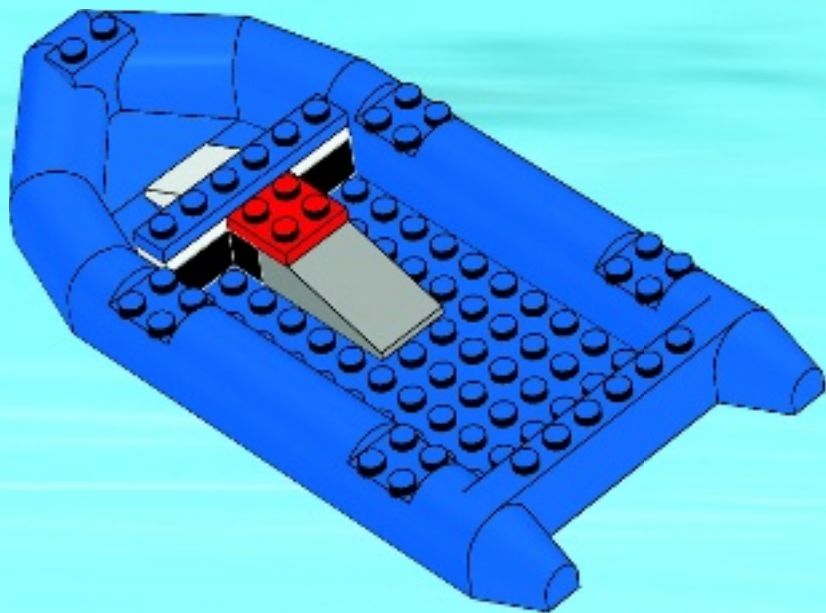



2x

8

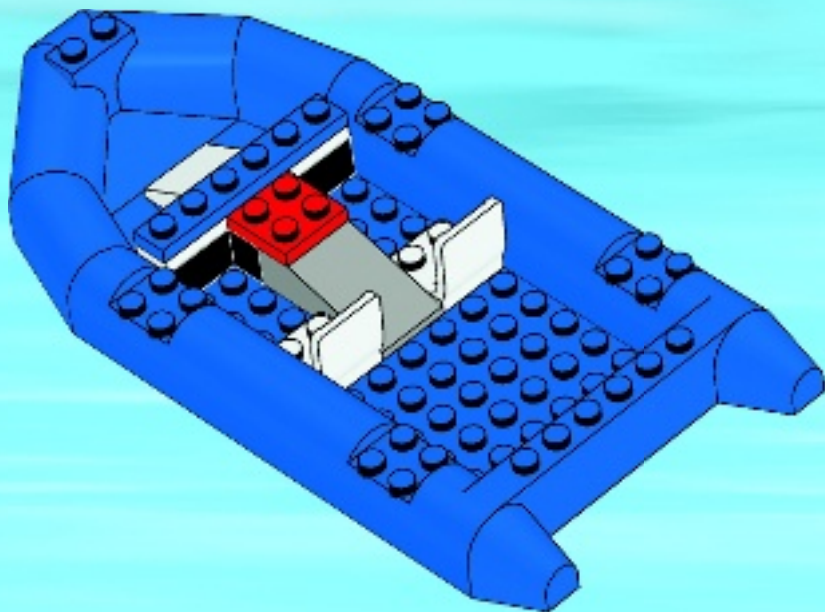



1x



2x



1x

9

1



2

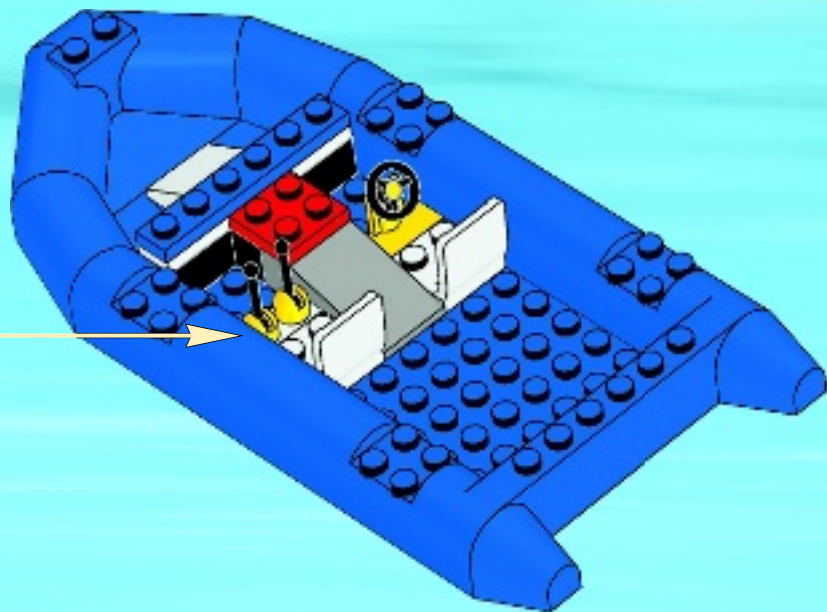



1x



1x



2x

10

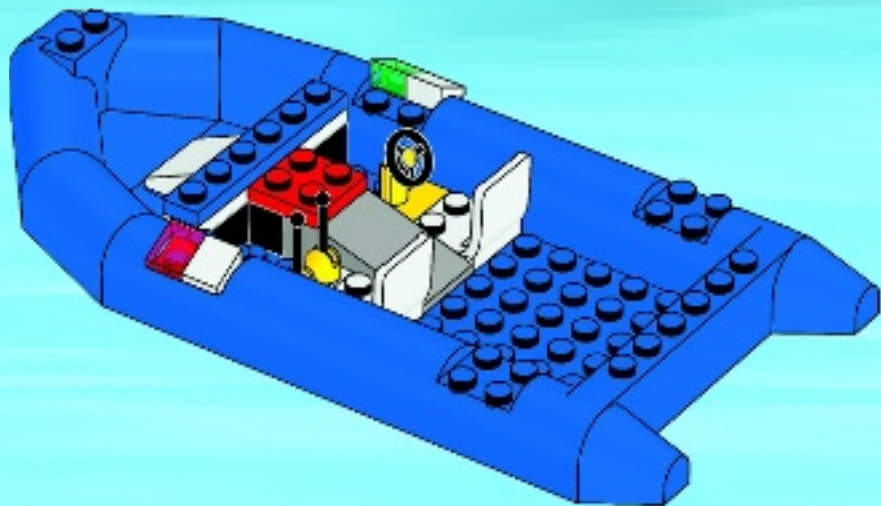



1x

11

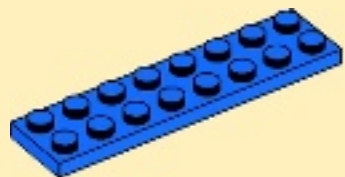
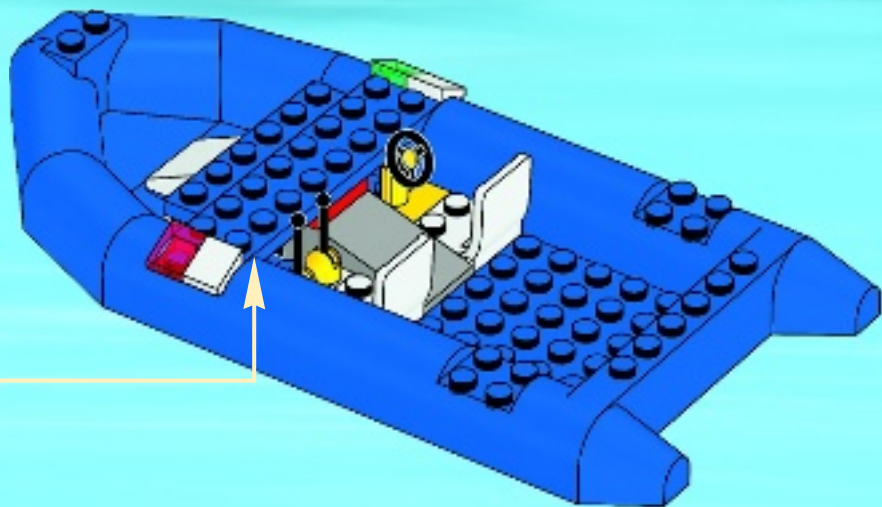



2x

12

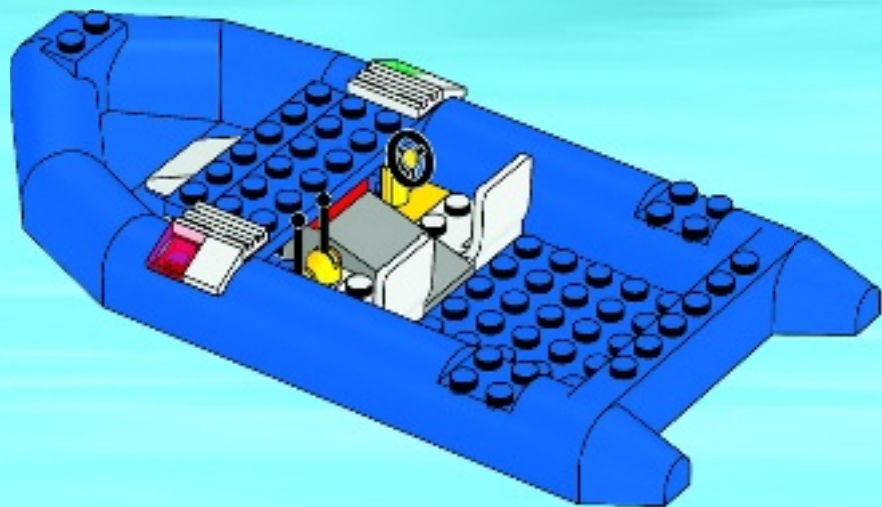

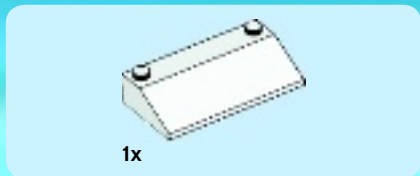

13

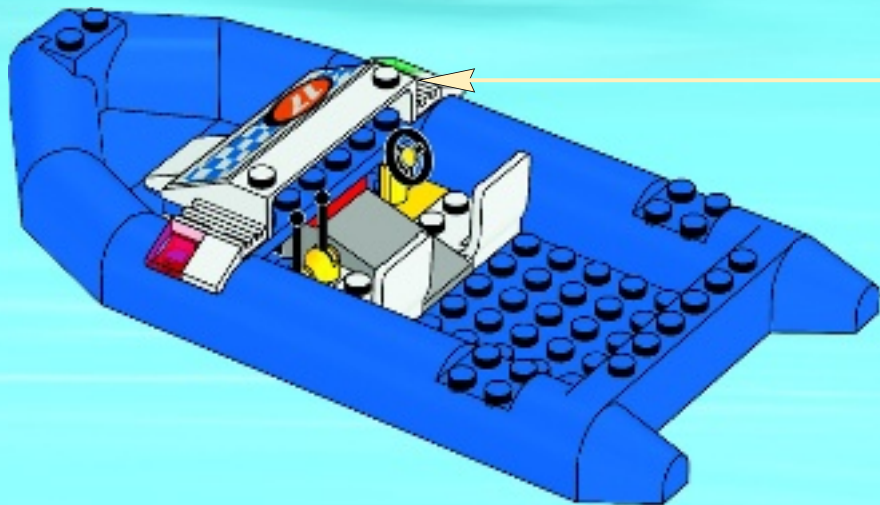
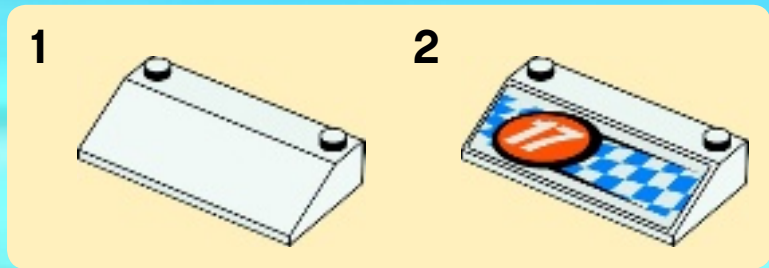



2x



2x

14

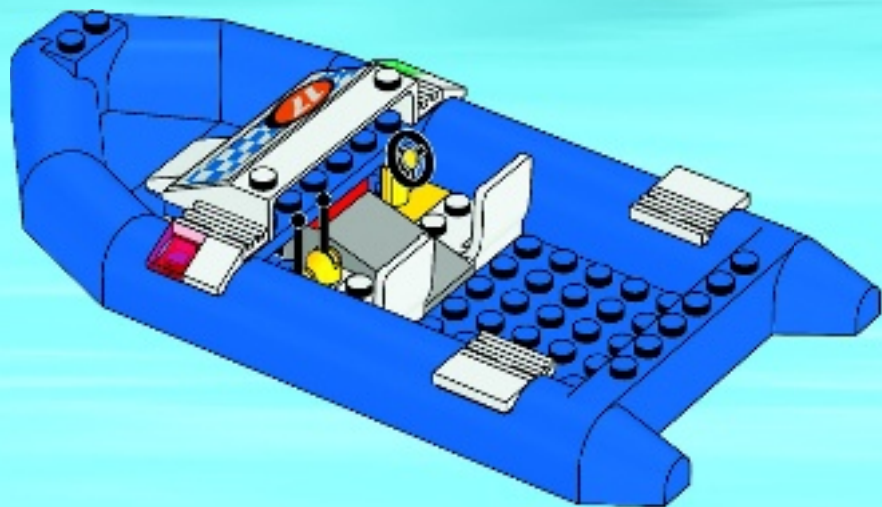



1x



1x



2x



2x

15

1



2



3



4

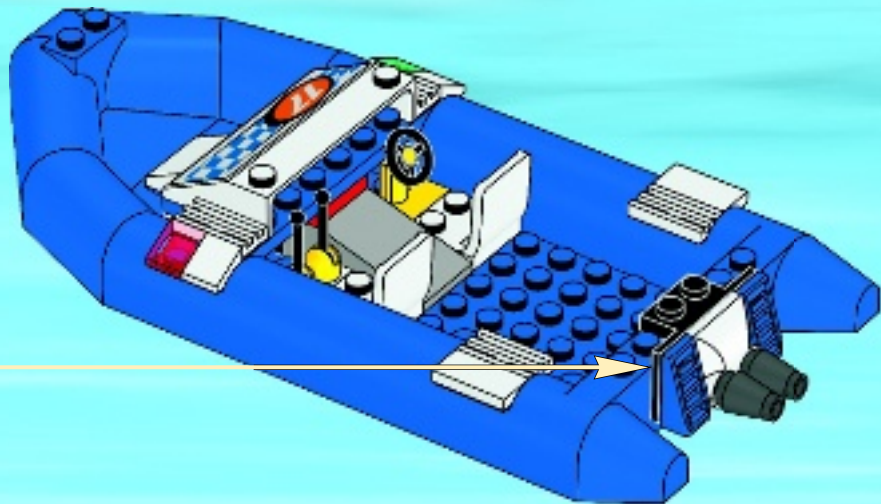



2x



1x

16





17

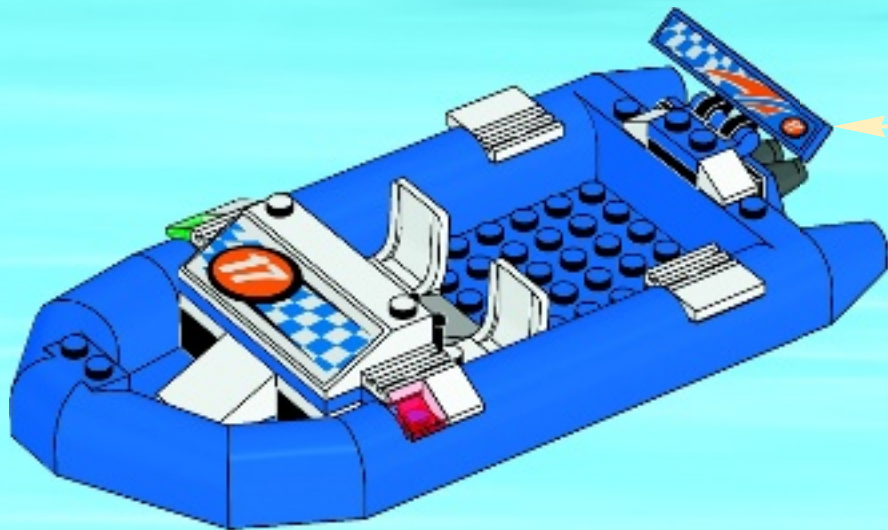
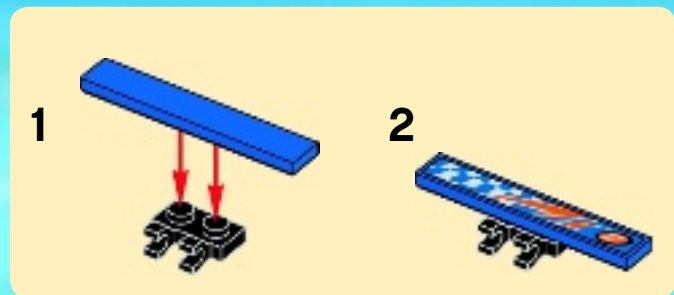

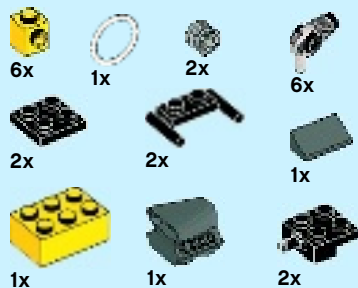

18

1

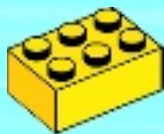

2



3



4



5



6



7



8



9



10

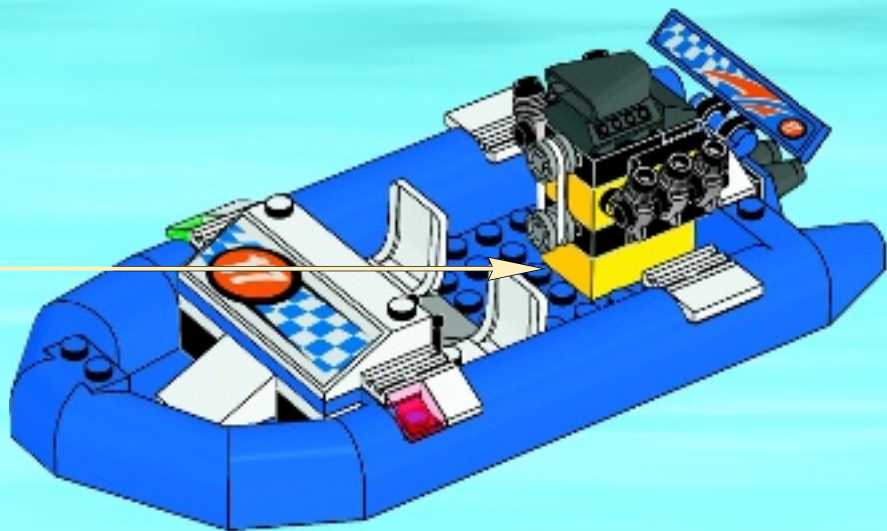

19

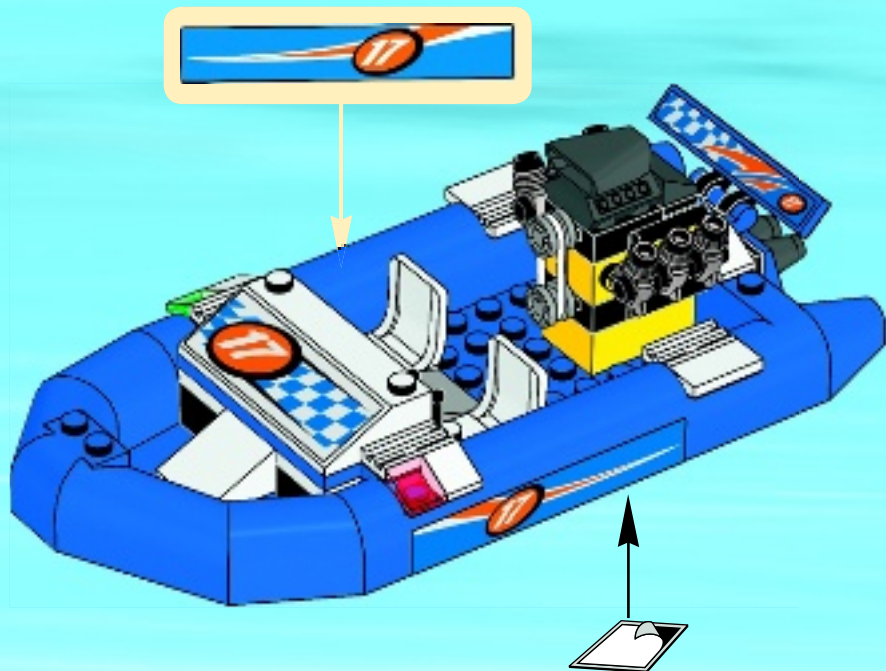



1x

20

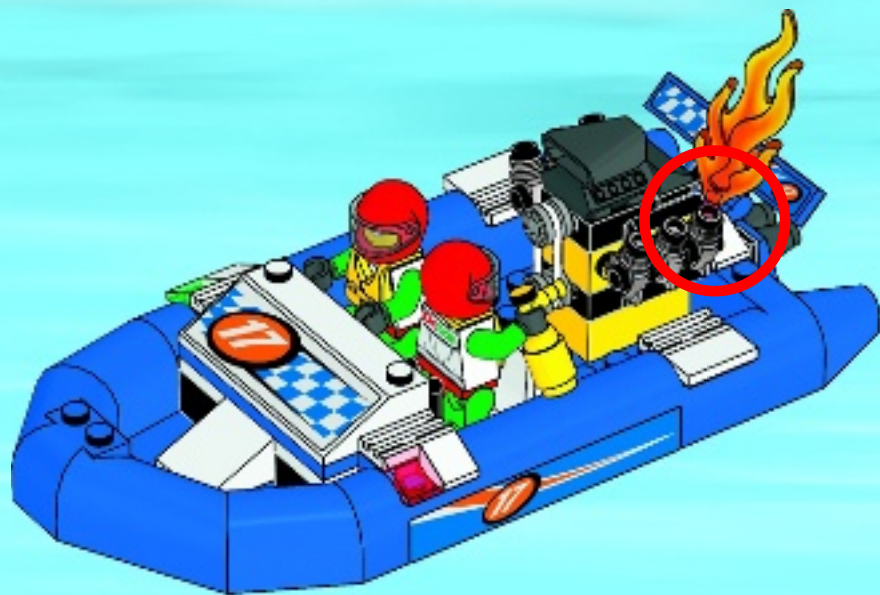



3x
300201



2x
300901



1x
4494474



2x
4547489



1x
329801



2x
379401



3x
302301



1x
366601



1x
346001

28



3x
306901



8x
241201



2x
407901



1x
4129836



1x
4560178



1x
6023310



1x
4611927



2x
234001



3x
6030716



6x
4504369



2x
6029181



1x
4544140



2x
4666579



2x
4611701



2x
4632572



4x
300421



2x
4121934



2x
4520782



1x
4116617



1x
4515348



2x
4588003



1x
302221



3x
371021



1x
366621



2x
4571075



1x
346021



2x
303421



1x
243221



4x
302321



2x
4298617



2x
302323



1x
4514398



2x
4597338



1x
4118785



1x
366623



1x
303423



1x
300224



2x
300124



6x
4624985



4x
306224



4x
614124



2x
4256320



2x
74156



2x
9553



1x
4652361



1x
6022320



1x
4654328



1x
4261572



1x
4527354



1x
4215263



4x
4648281



3x
300426



2x
302226

2x
4225201

1x
4616245

2x
383926

4x
4278359

2x
6018684

1x
6018496

1x
6018492

4x
4144023

1x
4556158

2x
448826

2x
4285883

2x
4177431

1x
396226

2x
6029173

1x
4244363

1x
3003941

1x
4548009

1x
4155537

2x
4113854

3x
3000844

1x
4244573

1x
4216384

2x
4163306

1x
4657954

1x
4650879

2x
4213383

1x
4622803

2x
4211397

1x
4211480

1x
4211414

2x
4556157

1x
4211632

4x
4515369

1x
4211475

2x
4211396

1x
4211445

1x
4509915

2x
4211658

2x
4211506

3x
4529240

1x
4567887

2x
4211133

1x
6030710

1x
4603504

3x
4211051

1x
4261908

1x
4502068

4x
4540386

6x
4625812

1x
4542700

2x
4210642

1x
6023141

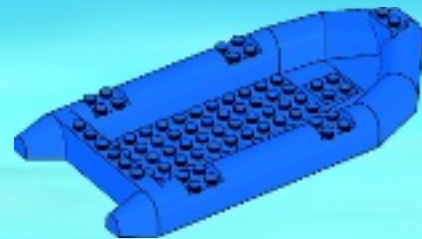

1x
4609642

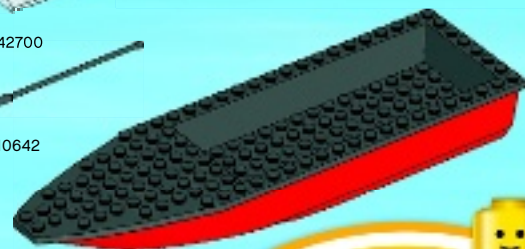

1x
6023141



Customer Service

Kundenservice

Service Consommateurs

Servicio Al Consumidor

LEGO.com/service or dial



: 00800 5346 5555

: 1-800-422-5346



CITY



60004



60003



60002



60001



60000



CITY

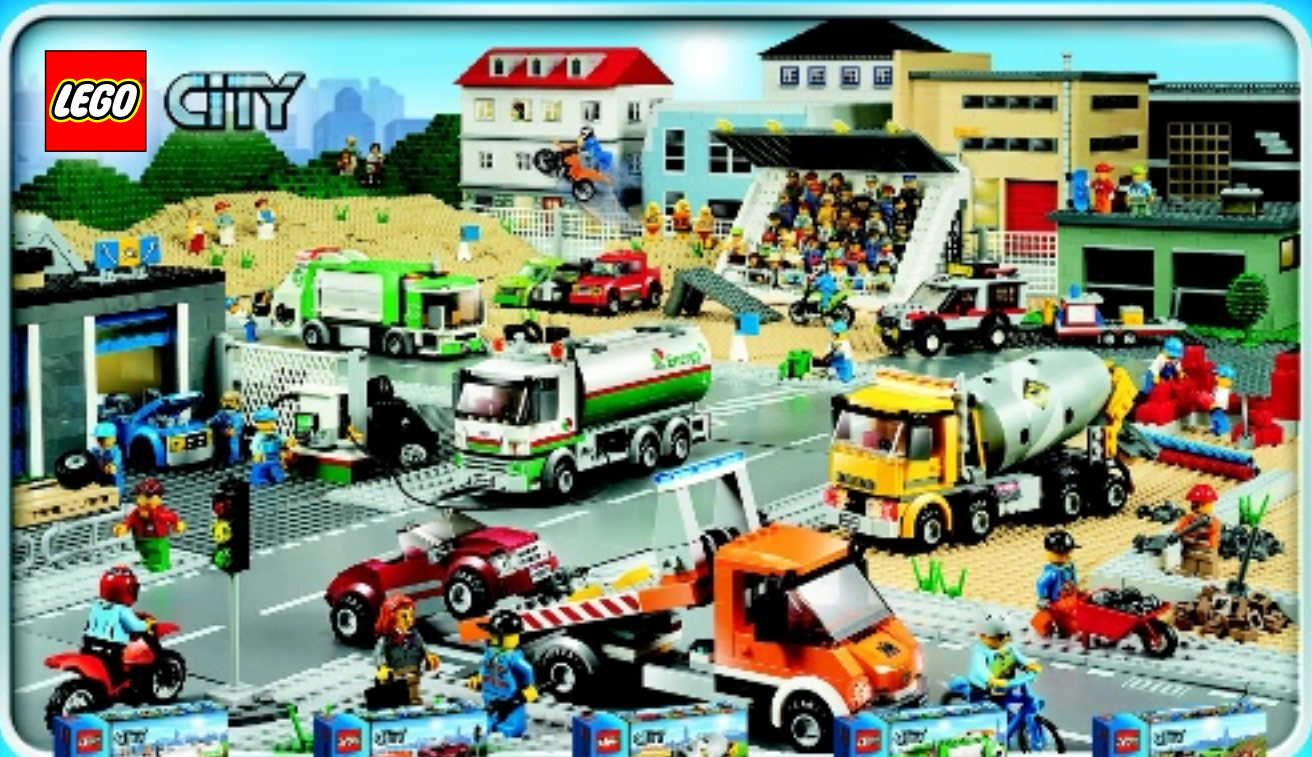

60016



60017



60018



4432



4433



WIN!

Go to www.LEGOsurvey.com/product to fill out a survey for a chance to win a cool LEGO® Product.

No purchase necessary.

Open to all residents where not prohibited.



www.LEGOsurvey.com/product

GEWINNE!

Nimm an der Umfrage auf www.LEGOsurvey.com/product teil und hab die Chance ein cooles LEGO® Produkt zu gewinnen!

Die Teilnahme am Gewinnspiel führt zu keinerlei Kaufverpflichtungen. Teilnahme in allen nicht ausgeschlossenen Ländern möglich.

WIN!

Ga naar www.LEGOsurvey.com/product, vul een enquêteformulier in en maak kans op een cool LEGO® product.

Geen aankoopverplichting. Iedereen mag deelnemen, uitgezonderd ingezetenden van landen waar een enquêteverbod geldt.

GAGNE !

Visite www.LEGOsurvey.com/product pour répondre à un questionnaire et avoir une chance de gagner un produit LEGO® très cool !

Aucune obligation d'achat. Ouvert à tous les résidents des pays autorisés.

当てよう!

www.LEGOsurvey.com/product にアクセスして、アンケートにご記入ください。当選者にはレゴ®製品を差し上げます。

お買い上げの必要はありません。禁止されていない限り、すべての皆様にご利用いただけます。



LEGO.com

6047576

LEGO and the LEGO logo are trademarks of the/son des marques de commerce de/son marcas registradas de LEGO Group. ©2013 The LEGO Group.