



TECHNIC[™]

42148





Get excited about our new packaging!

We're switching from plastic to paper-based packaging. That's why you might find a mix of paper and plastic in our boxes!

Nos nouveaux emballages vous emballeront !

Nous passons des emballages en plastique aux emballages à base de papier. C'est pourquoi vous pourriez trouver un mélange de papier et de plastique dans nos boîtes !

¡Te presentamos nuestros nuevos empaques!

Estamos sustituyendo las bolsas de plástico por bolsas con base de papel. ¡Por eso, puedes encontrar una mezcla de papel y de plástico en nuestras cajas!

[LEGO.com/sustainable-packaging](https://www.lego.com/sustainable-packaging)

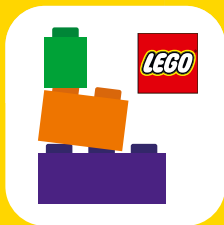

BUILDER



Apple and the Apple logo are trademarks of Apple Inc., registered in the U.S. and other countries and regions. App Store is a service mark of Apple Inc. Google Play and the Google Play logo are trademarks of Google LLC. Tencent and the Tencent logo are trademarks of Tencent Inc.

🔍 LEGO.com/devicecheck

EN Ask parents' permission before going online | **DE** Eltern um Erlaubnis bitten, bevor du online gehst | **FR** Demande l'autorisation d'un parent avant d'aller en ligne | **IT** Chiedi il permesso ai tuoi genitori prima di andare online | **ES** Pídeles permiso a tus papás antes de conectarte a Internet | **PT** Pedir autorização aos pais antes de acederes online | **JA** オンラインになる前に ほご者の方のきよかをもらおう | **ZH** 上网前应先征得父母的同意 | **KO** 온라인 접속 전에 보호자 동의가 필요합니다 | **RU** Спроси разрешения у родителей, прежде чем заходить в интернет | **PL** Poproś rodziców o zgodę, zanim wejdiesz do Internetu | **CS** Než půjdeš na internet, požádej rodiče o svolení | **SK** Skôr než pôjdeš na internet, vypýtaj si povolenie od rodičov | **HU** Kérj szülői engedélyt, mielőtt online csatlakoznál! | **RO** Cere permisiunea părinților înainte de a te conecta online | **BG** Поискайте разрешение от родител, преди да влезете онлайн | **LV** Pirms došanās tiešsaistē palūdz atļauju vecākiem | **ET** Enne Interneti kasutamist küsi vanematelt luba | **LT** Prieš prisijungdami prie interneto, atsiklauskite tėvų





1

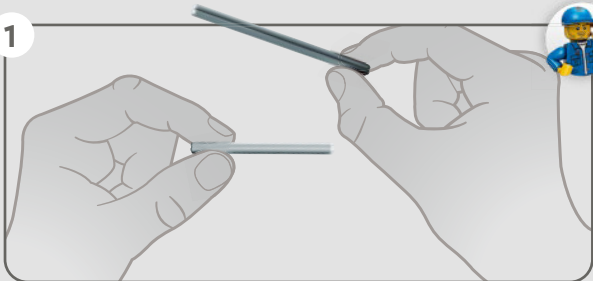

2

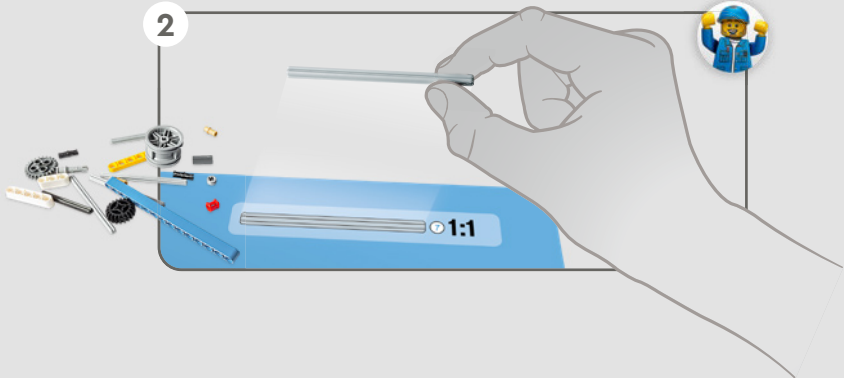

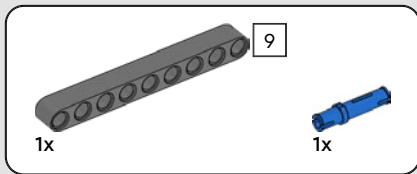

1

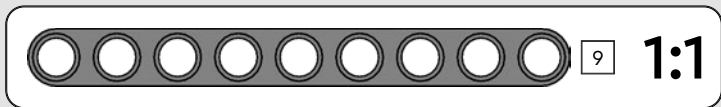
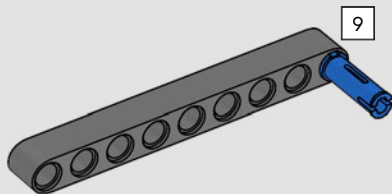

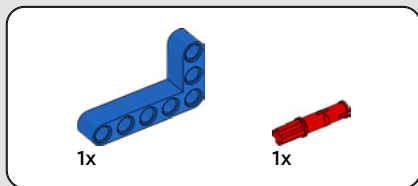

2

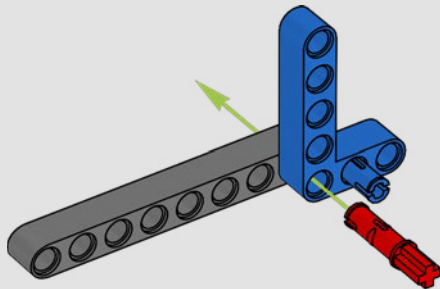



1x



1x

3

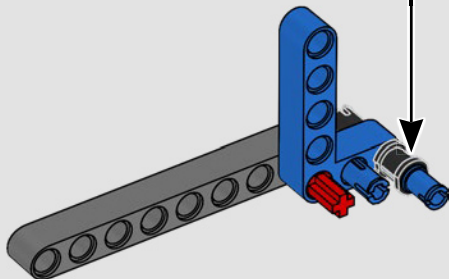
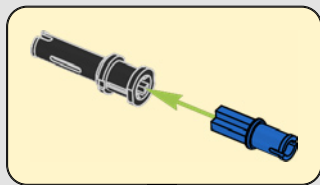



1x



1x

4

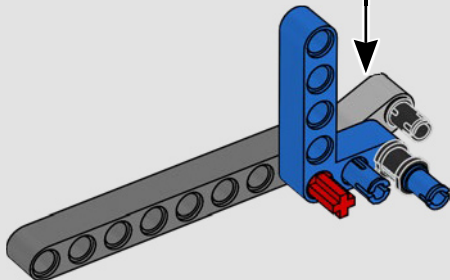
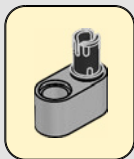



1x



1x

5

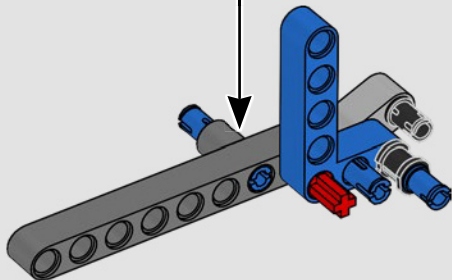
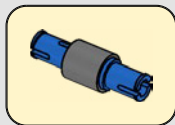



1x



1x

6

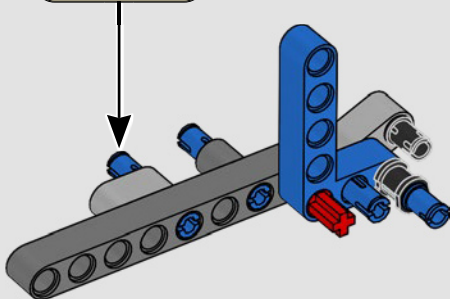
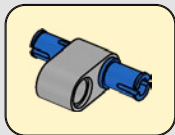

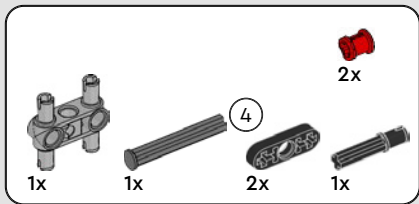

7

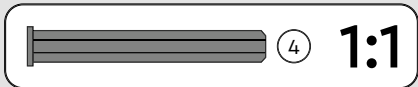
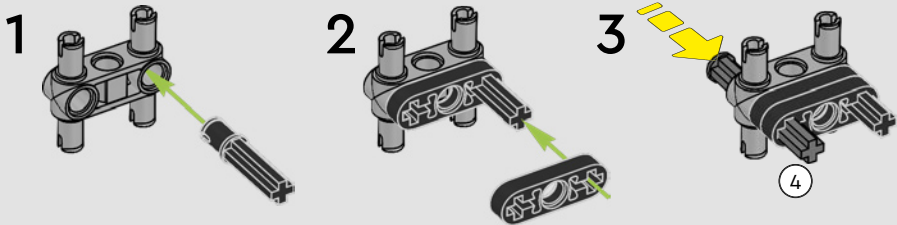

4

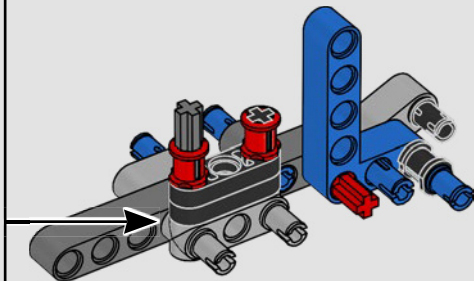
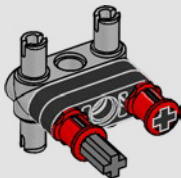

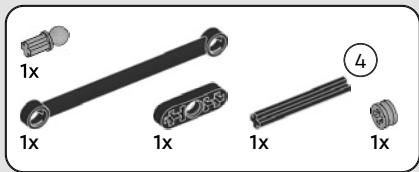

8

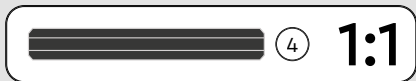
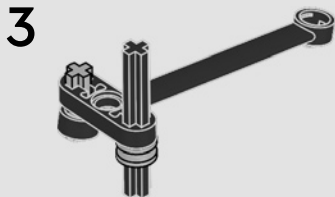
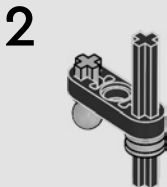
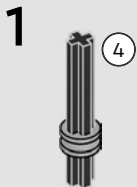

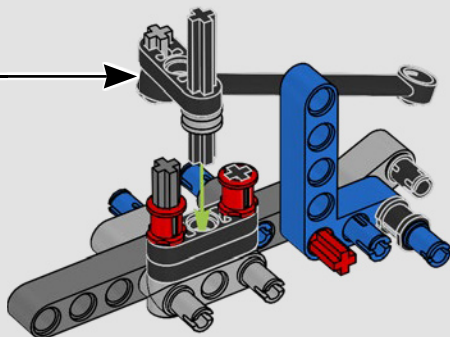



2x

9

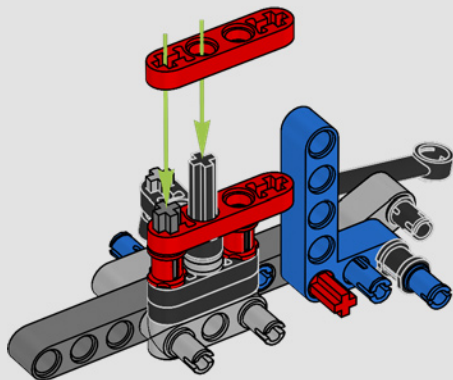

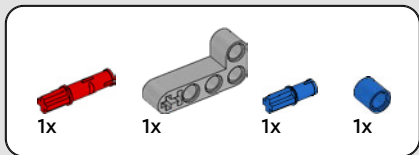

11

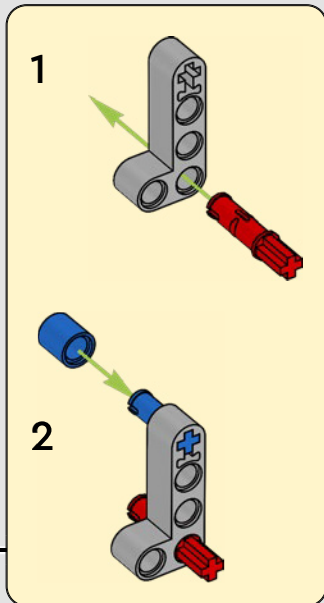
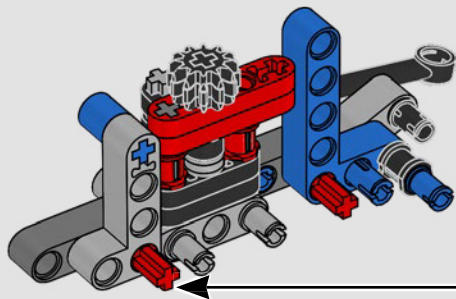



1x



2x

12

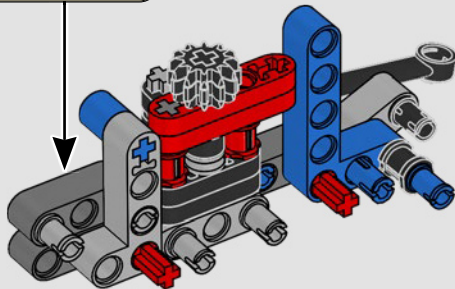
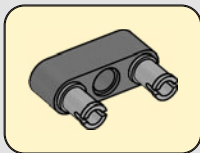

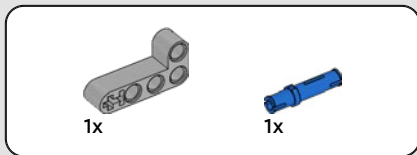

13

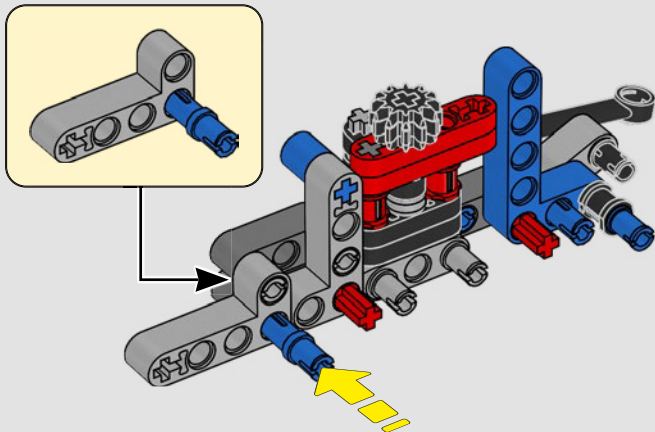

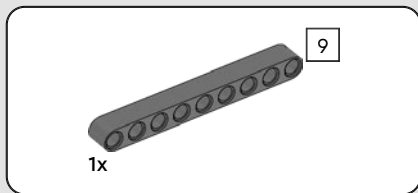

14

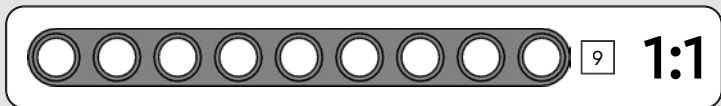
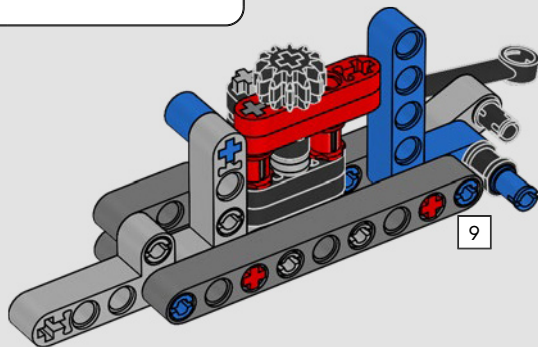

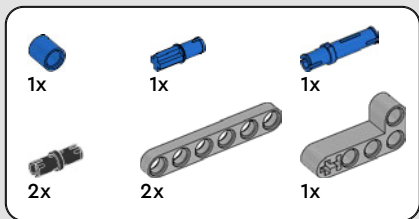

15

1

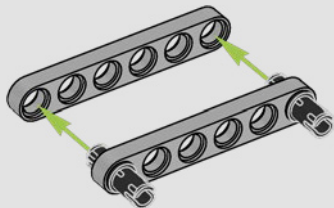

2

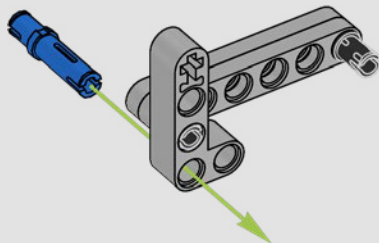

3

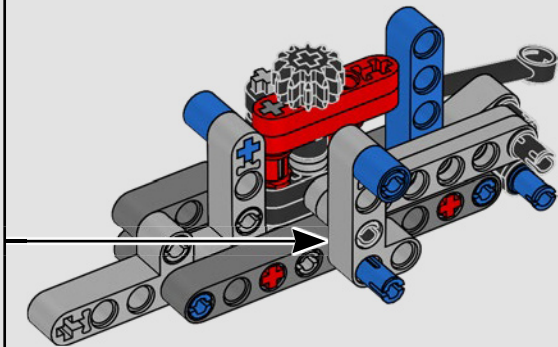
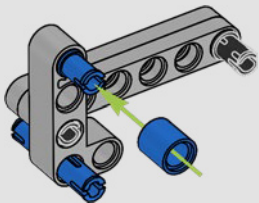



1x



1x

16

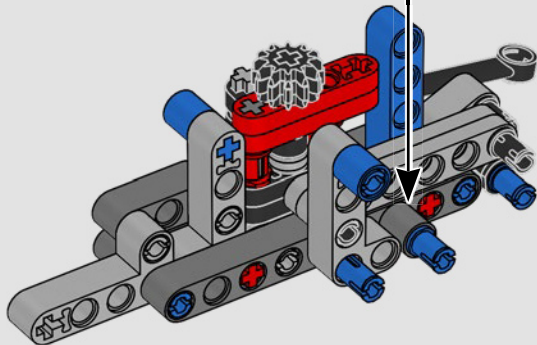
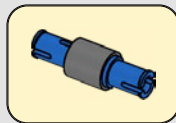

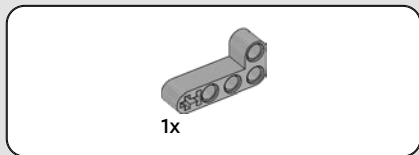

17

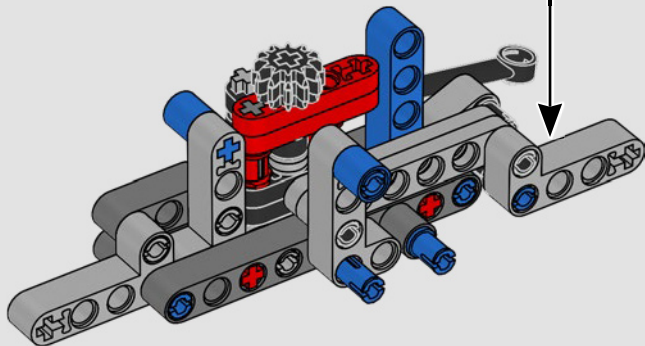
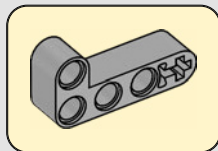

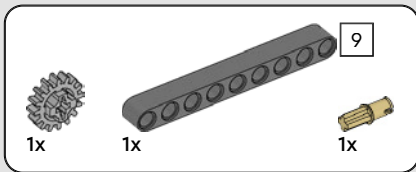
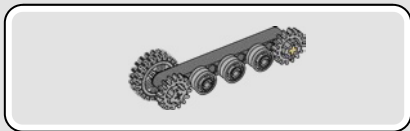

18

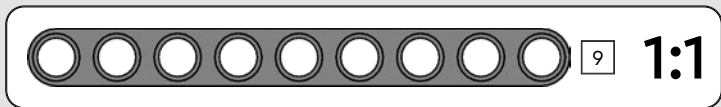
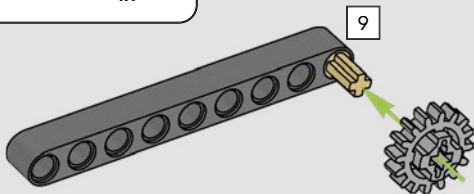



3x

19

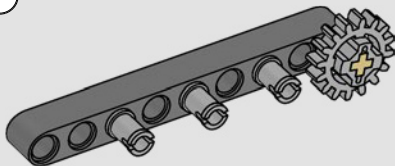

3x

20

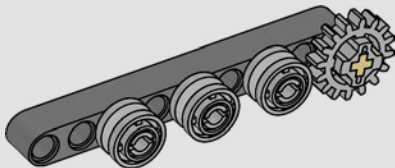

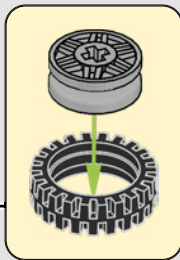
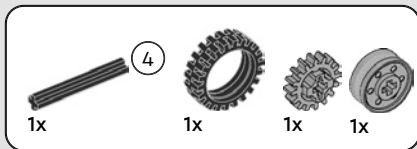

21

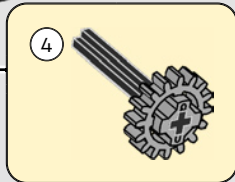
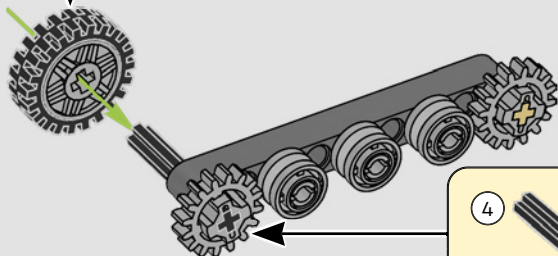

22

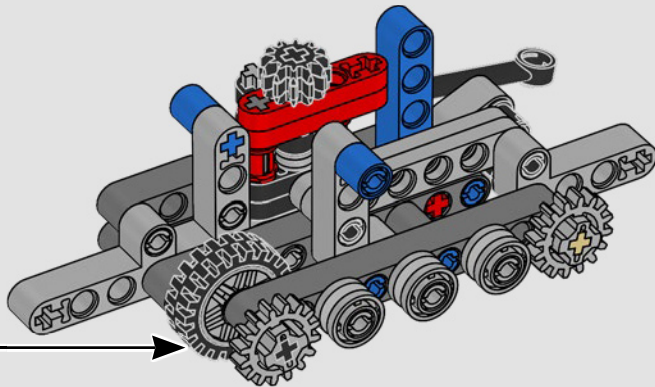

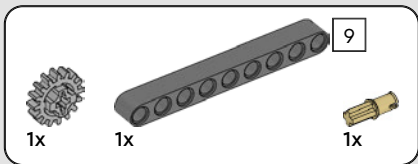
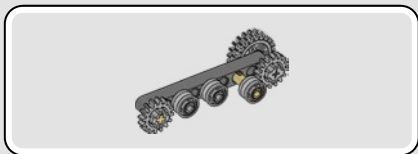

23

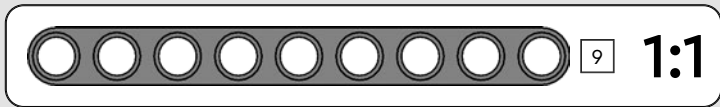
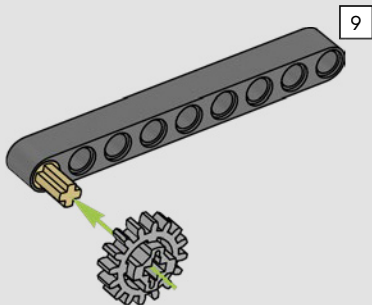



2x



1x

24

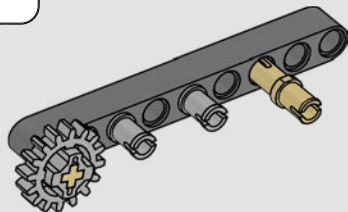

3x

25

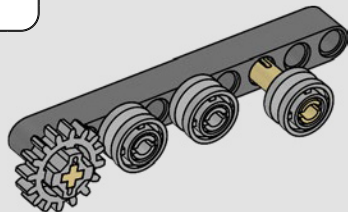

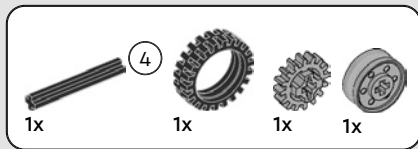

26

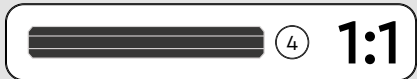
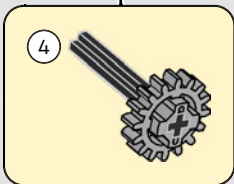
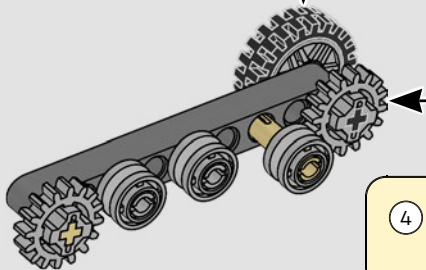
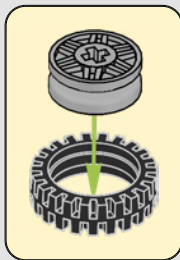

27

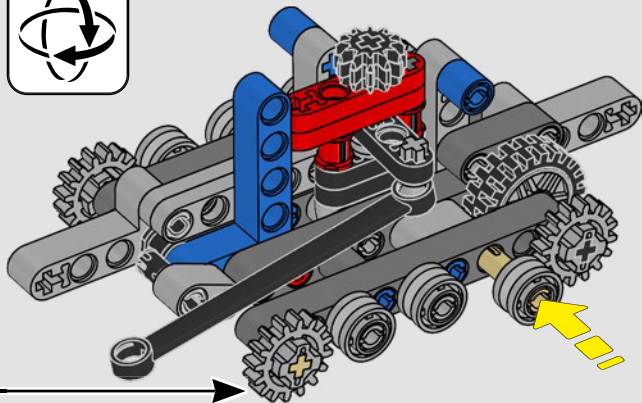

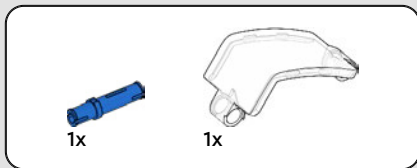

28

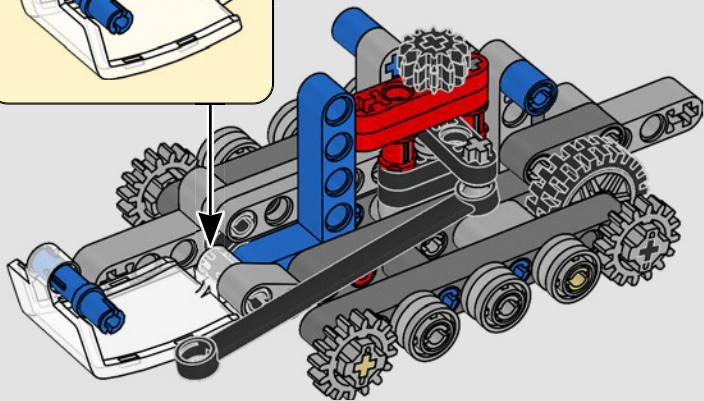
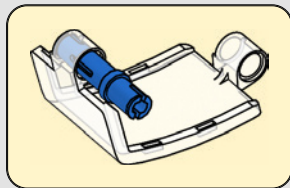

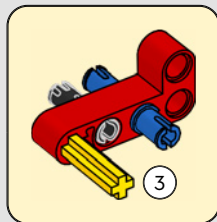
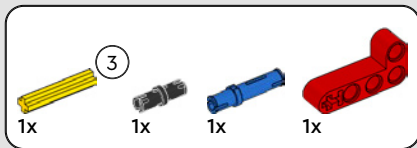

29

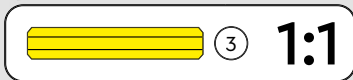
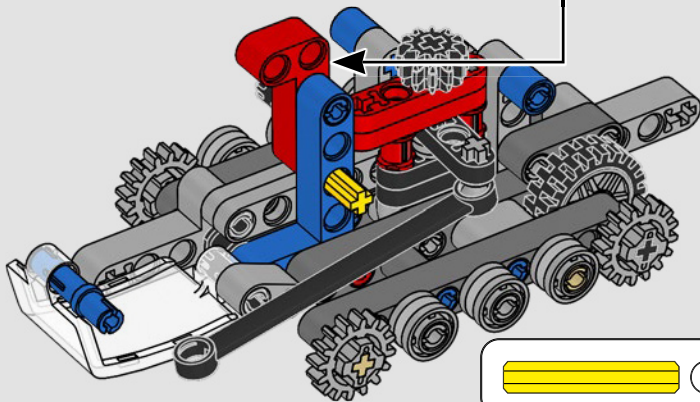

30

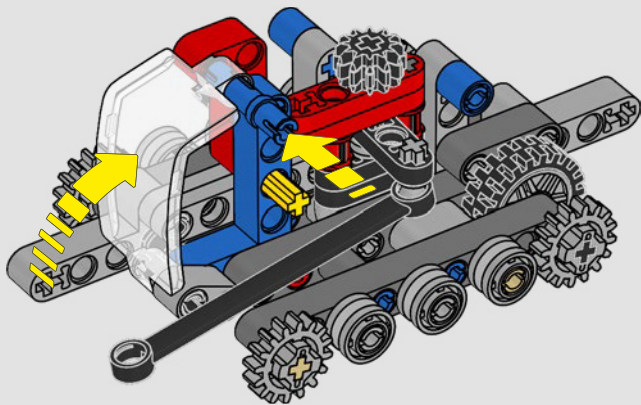

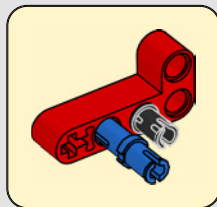
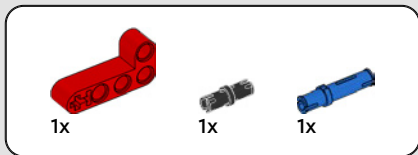

31

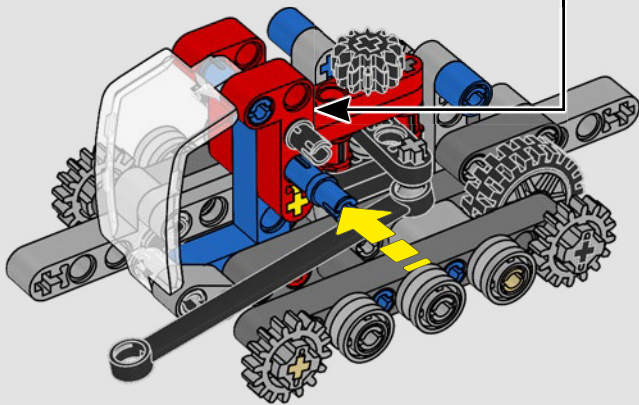

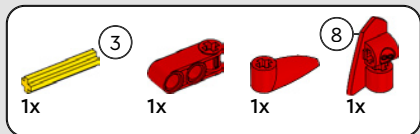

32

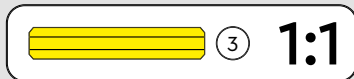
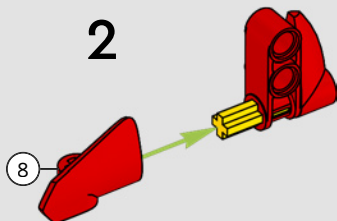
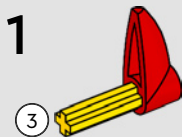

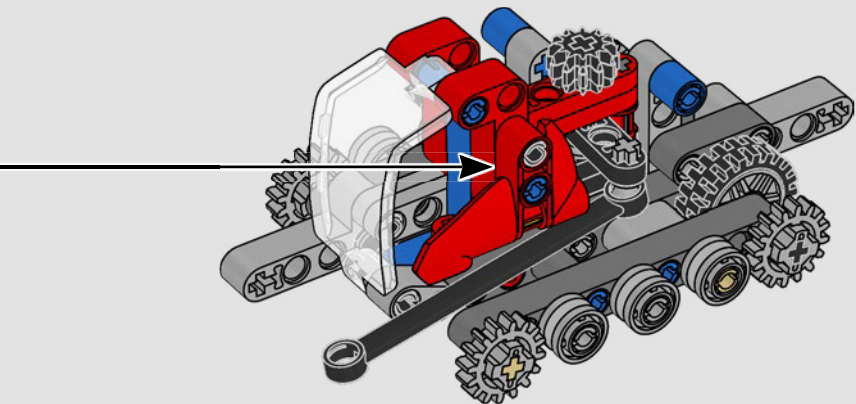

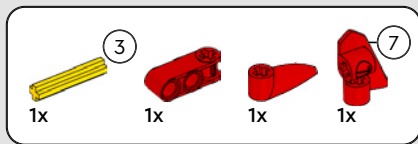

33

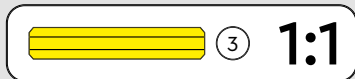
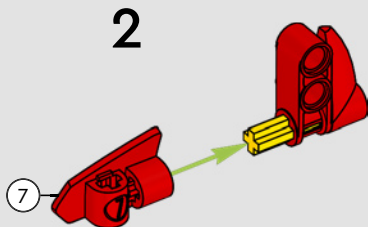
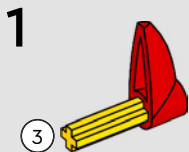

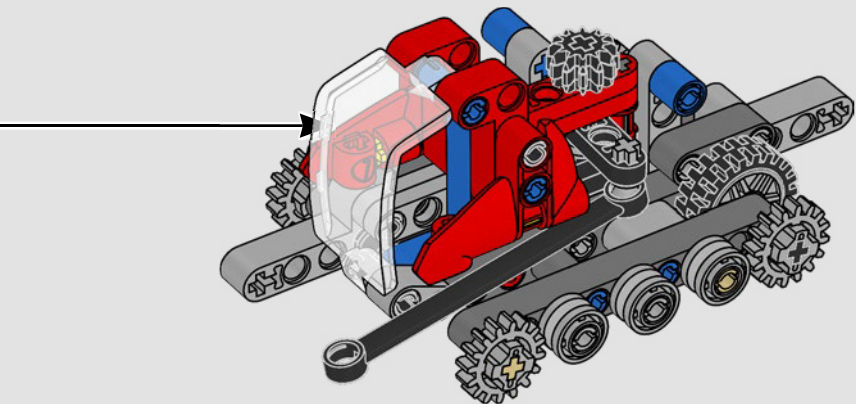

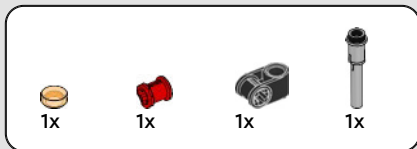

34

1



2

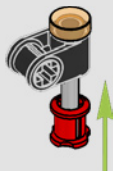

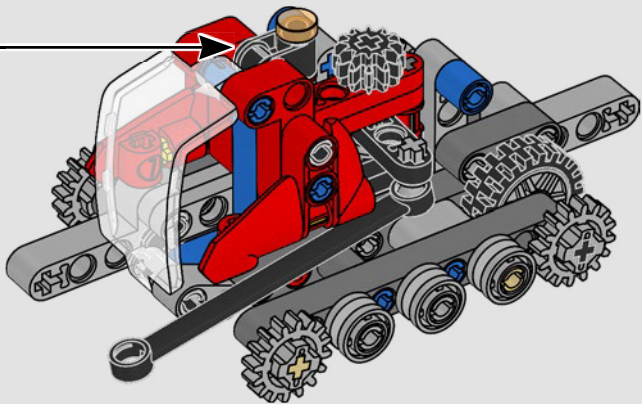

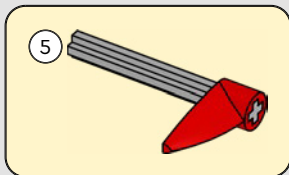
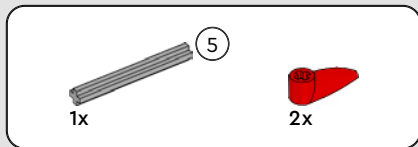

35

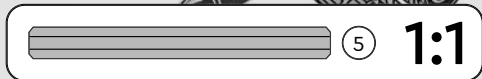
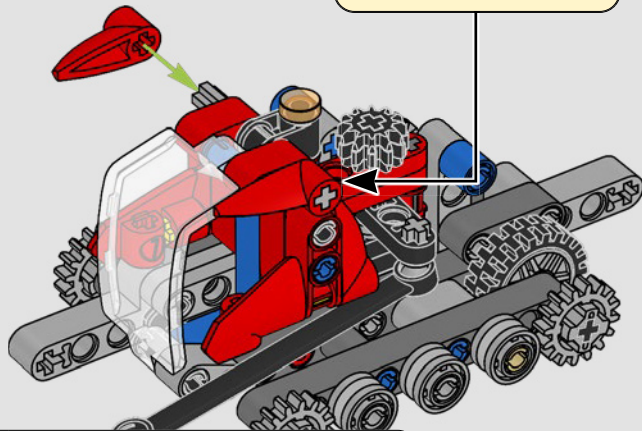



36

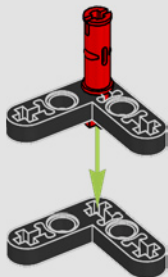

37

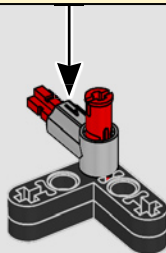
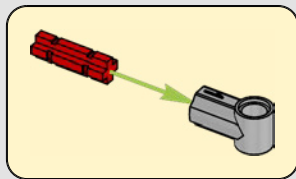



1x



1x

38

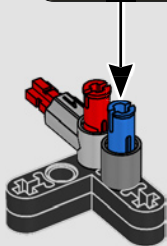
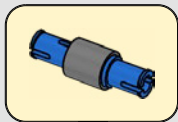

39

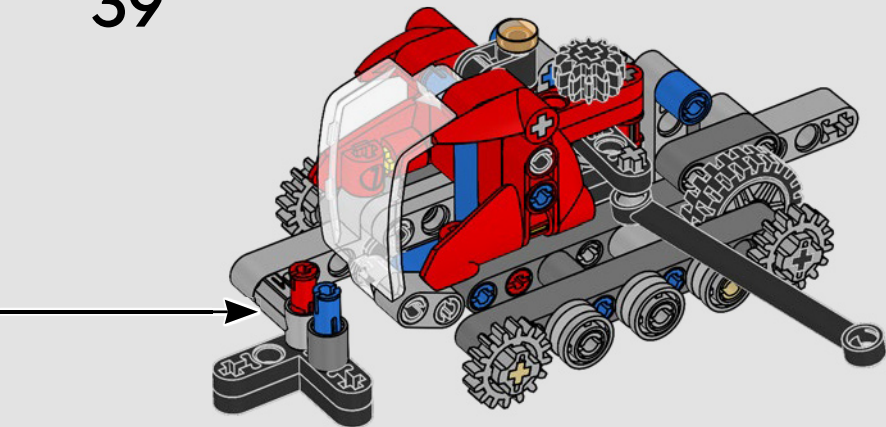



1x



1x

40

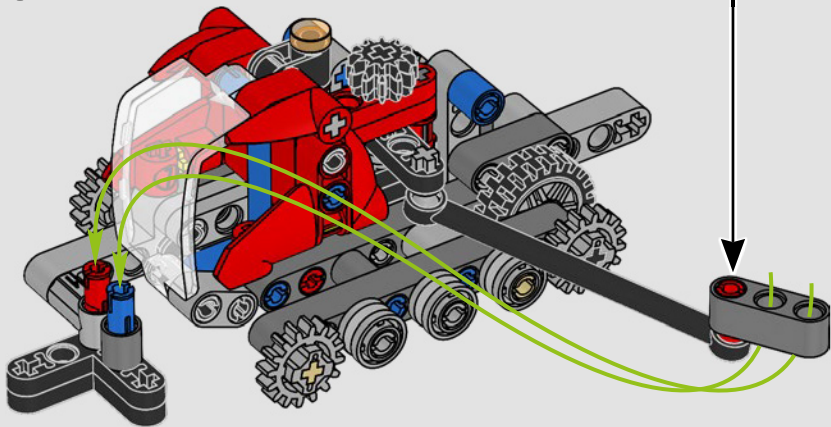
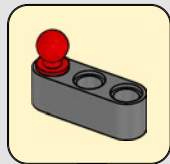



1x

41

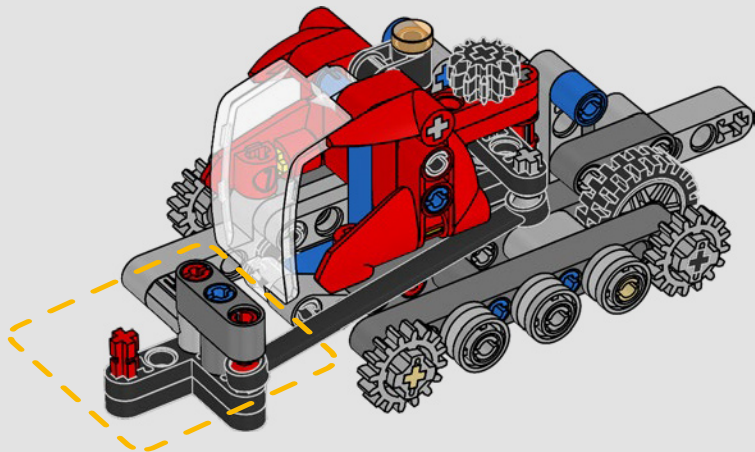

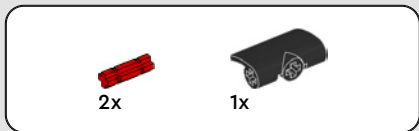
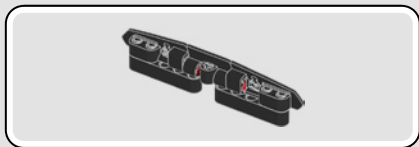

42



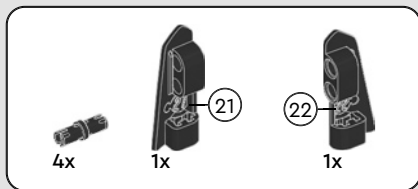

43

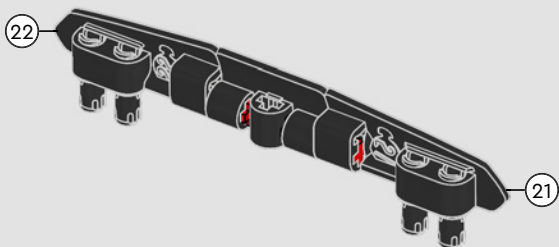

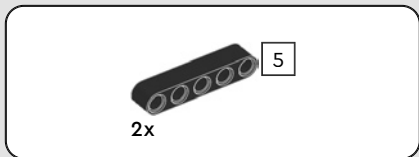

2x

44

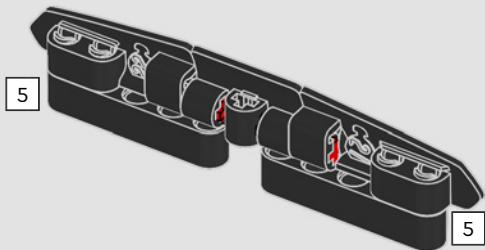

45

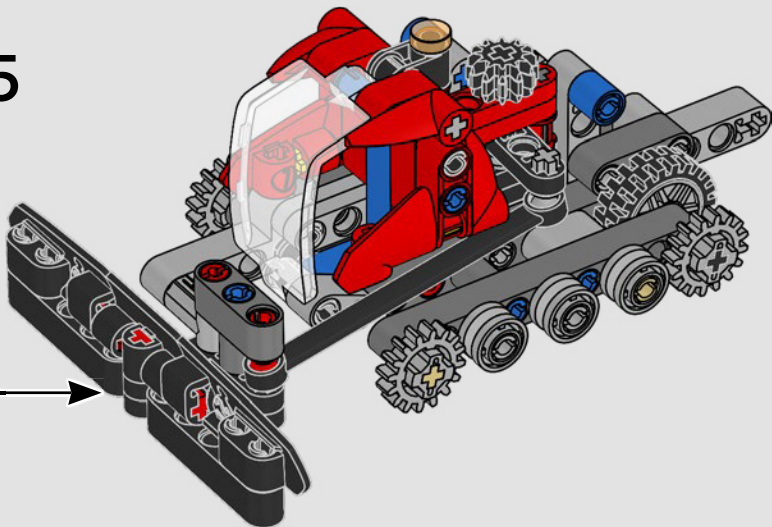

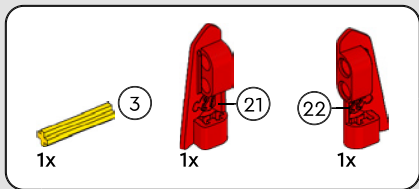

46

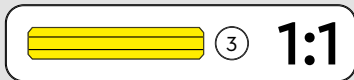
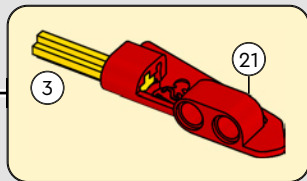
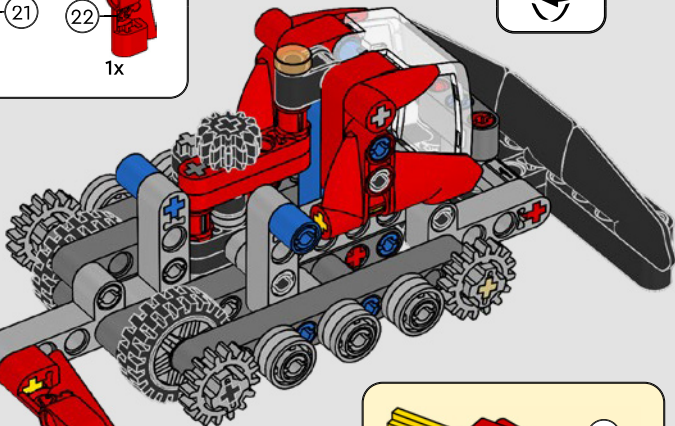
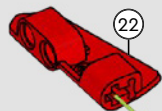



56x

47



28x

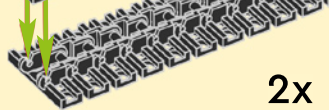

2x

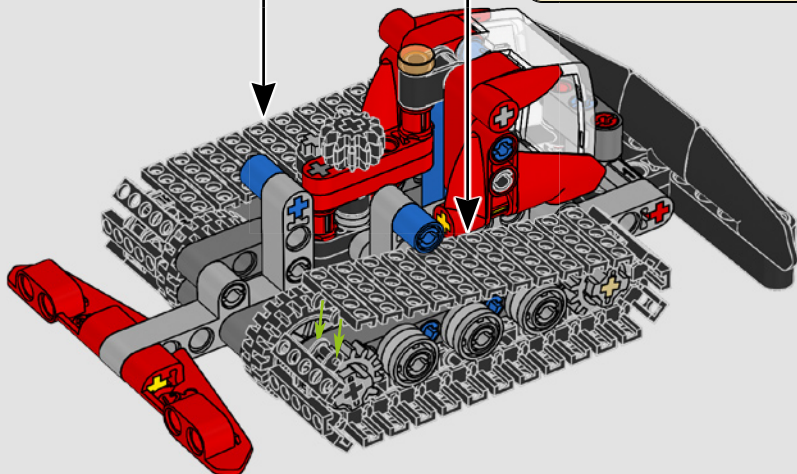

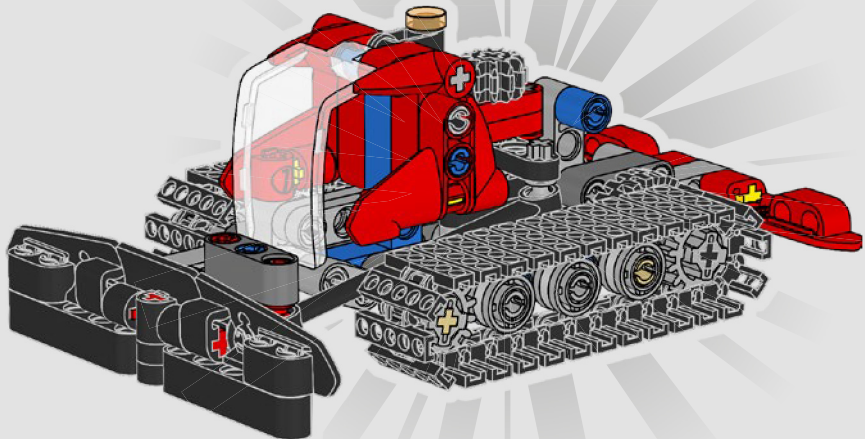

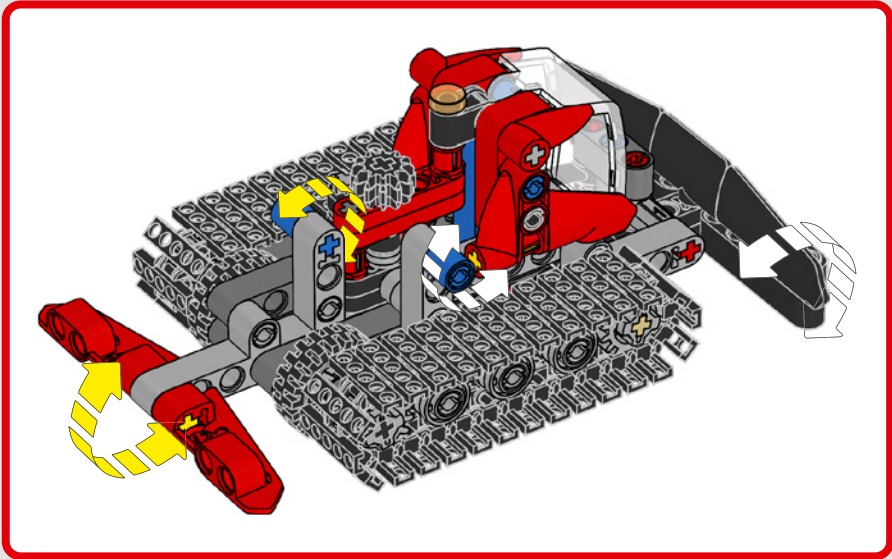

2x
4666579

1x
6321305

3x
6271820

1x
6408165

1x
6360104

1x
6343986

1x
6408166

1x
6340601

4x
4142865

4x
6285599

2x
6273712

3x
6209519



2x
6330205

2x
6271827

2x
6392879

3x
4206482

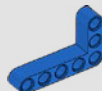
10x
6299413

1x
4158923

4x
6130007

1x
4177431

1x
6319983

1x
6316923

1x
6261371

56x
6047885

9x
6279875

3x
6331723



2x
6271810

1x
6089119

1x
6321745

2x
4541455

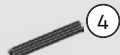
1x
6331026

3x
370526

2x
4142135

1x
6244698



1x
6329052



1x
6274747



1x
6347715



1x
6271165



1x
6296859



6x
4211758



1x
4211375



7x
4211807



4x
4640536



2x
4211862



2x
6357599



1x
6282158



4x
6271831



1x
4211639



2x
6170293



3x
6100030



2x
4210751



4

1x
6083620

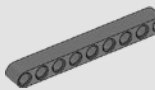

9

4x
4645730

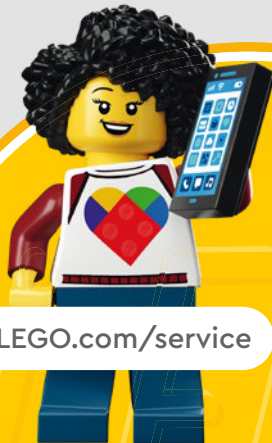

LEGO.com/service

YOU COULD

WIN



Scan this QR code or go to
LEGO.COM/PRODUCTFEEDBACK and give us
your short feedback about this LEGO® set
for a chance to win a cool LEGO prize.

Terms and Conditions apply*

DE: Du könntest GEWINNEN. Es gelten die Teilnahmebedingungen* **FR: Tu pourrais GAGNER.** Des conditions s'appliquent* **IT: Potresti VINCERE tu.** Termini e condizioni sono applicabili* **ES: Puedes GANAR.** Aplican términos y condiciones* **PT: Poderá GANHAR.** Aplicam-se termos e condições* **JA: プレゼント付き! 利用規約が適用されます*** **ZH: 轻松获奖. 条款和条件适用*** **KO: 상품의 주인이 되어보세요. 소정의 약관이 적용됩니다*** **RU: Вы можете ВЫИГРАТЬ.** Действуют положения и условия* **PL: Szansa na WYGRANĄ.** Obowiązują warunki korzystania* **CS: Máte šanci VYHRÁT.** Platí všeobecné smluvní podmínky* **SK: Máte šancu VYHRATĚ.** Platia všeobecné zmluvné podmienky* **HU: TE IS NYERHETSZ.** Felhasználási feltételek érvényesek* **RO: Ai putea CĂȘTIGA.** Se aplică termenii și condiții* **BG: Можете да СПЕЧЕЛИТЕ.** Има определени правила и условия* **LV: Tu vari LAIMĒT.** Ir spēkā noteikumi un nosacījumi.* **ET: Sul on võimalus VÕITA.** Kehtivad tingimused* **LT: Jūs galite LAIMĖTI.** Taikomos sąlygos*

*[LEGO.com/productfeedback-terms](https://www.lego.com/productfeedback-terms)

LEGO and the LEGO logo are trademarks of the/son des marques de commerce du/
son marcas registradas de LEGO Group. ©2023 The LEGO Group.

6442285