



# Friends

41754



**WARNING: CHOKING HAZARD.** Toy contains small parts and a small ball. Not for children under 3 years.



### **Get excited about our new packaging!**

We're switching from plastic to paper-based packaging. That's why you might find a mix of paper and plastic in our boxes!

### **Nos nouveaux emballages vous emballeront !**

Nous passons des emballages en plastique aux emballages à base de papier. C'est pourquoi vous pourriez trouver un mélange de papier et de plastique dans nos boîtes !

### **¡Te presentamos nuestros nuevos empaques!**

Estamos sustituyendo las bolsas de plástico por bolsas con base de papel. ¡Por eso, puedes encontrar una mezcla de papel y de plástico en nuestras cajas!

**[LEGO.com/sustainable-packaging](https://www.lego.com/sustainable-packaging)**



# BUILDER



Apple and the Apple logo are trademarks of Apple Inc., registered in the U.S. and other countries and regions. App Store is a service mark of Apple Inc. Google Play and the Google Play logo are trademarks of Google LLC. Tencent and the Tencent logo are trademarks of Tencent Inc.

Q [LEGO.com/devicecheck](https://LEGO.com/devicecheck)

**EN** Ask parents' permission before going online | **DE** Eltern um Erlaubnis bitten, bevor du online gehst | **FR** Demande l'autorisation d'un parent avant d'aller en ligne | **IT** Chiedi il permesso ai tuoi genitori prima di andare online | **ES** Pídeles permiso a tus papás antes de conectarte a Internet | **PT** Peça autorização aos pais antes de acederes online | **JA** オンラインになる前に ほご者の方のきょかをもらおう | **ZH** 上网前应先征得父母的同意 | **KO** 온라인 접속 전에 보호자 동의가 필요합니다 | **RU** Спроси разрешения у родителей, прежде чем заходить в интернет | **PL** Poproś rodziców o zgodę, zanim wejdiesz do Internetu | **CS** Než půjdeš na internet, požádej rodiče o svolení | **SK** Skôr než pôjdeš na internet, vypýtaj si povolenie od rodičov | **HU** Kérj szülői engedélyt, mielőtt online csatlakoznál! | **RO** Cere permisiunea părinților înainte de a te conecta online | **BG** Поискайте разрешението от родители, преди да влезете онлайн | **LV** Pirms došanās tiešsaistē palūdz atļauju vecākiem | **ET** Enne Interneti kasutamist küsi vanematelt luba | **LT** Prieš prisijungdami prie interneto, atsklaukite tėvų

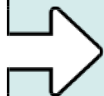
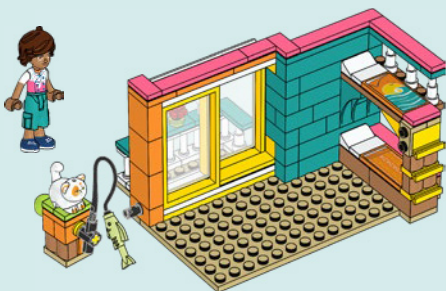
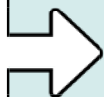

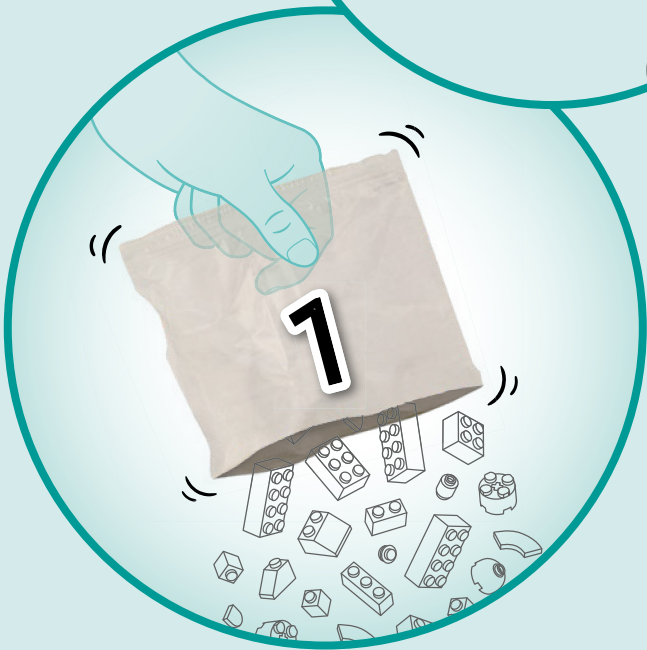
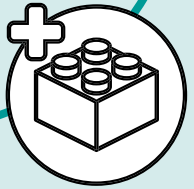
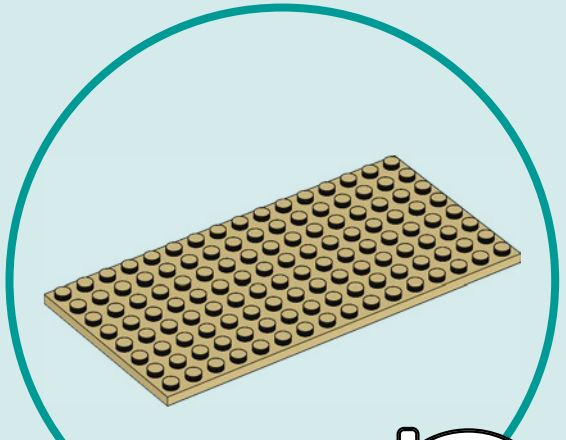



## AVERTISSEMENT :

RISQUE D'ÉTOUFFEMENT. Le jouet contient des petites pièces ainsi qu'une petite boule. Il ne convient pas aux enfants de moins de 3 ans.



## ADVERTENCIA:

PELIGRO DE ASFIXIA.

Juguete que contiene partes pequeñas y una pelota pequeña. No recomendado para niños menores de 3 años.

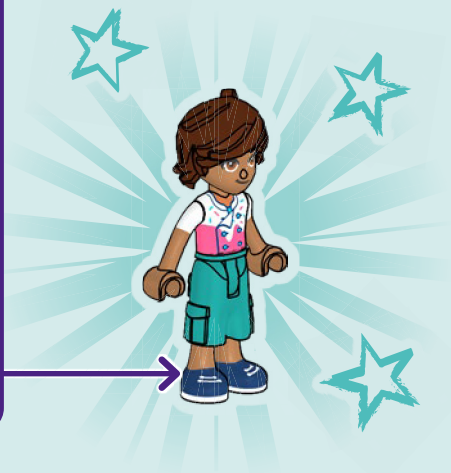
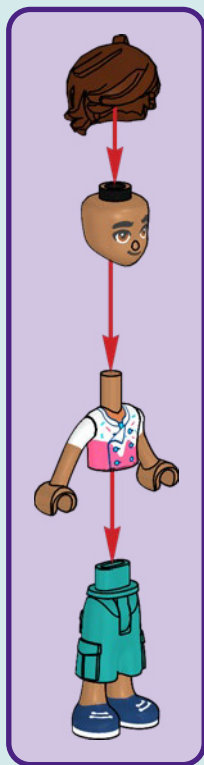

LEO

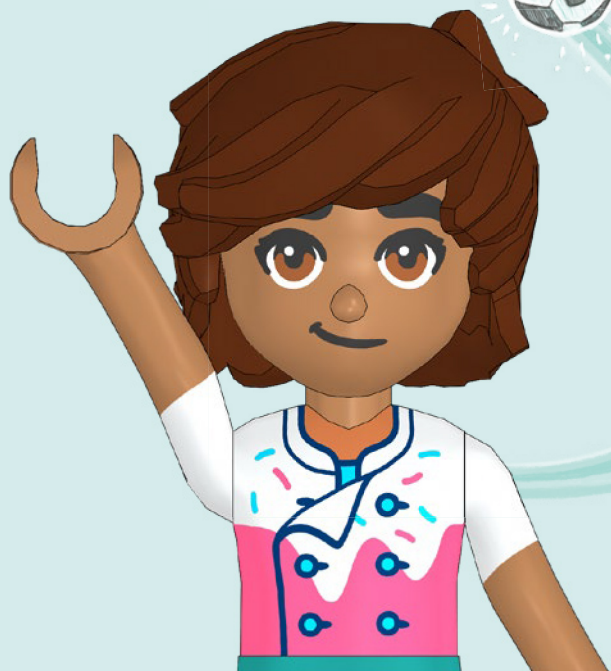

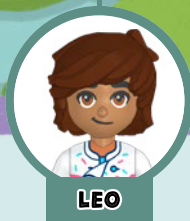
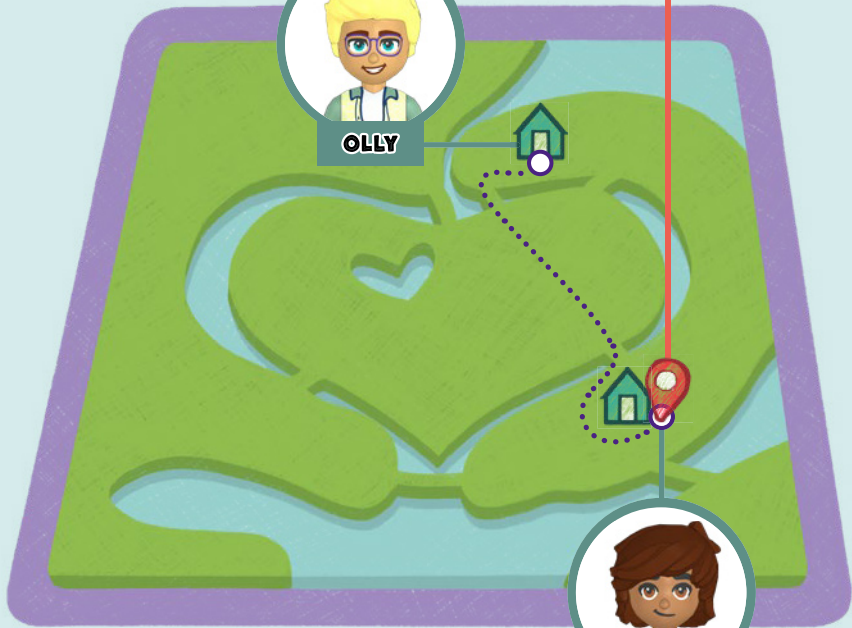





1x



1x

1

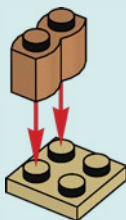

1x

2





2x

3

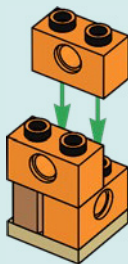



1x

4

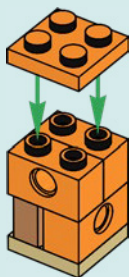

2x

5



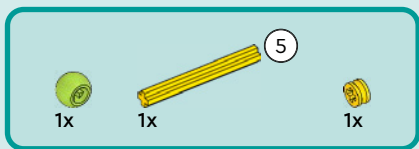

6

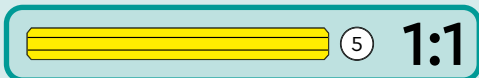
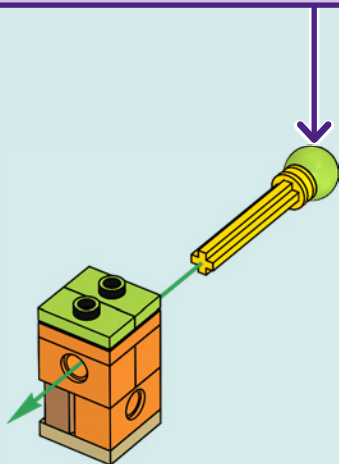
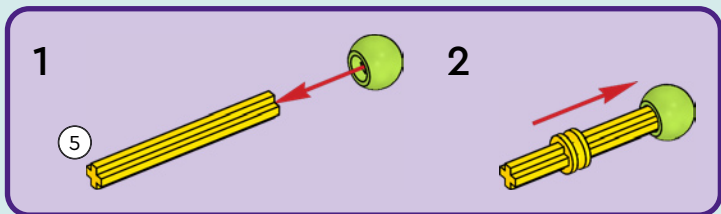



1x

7

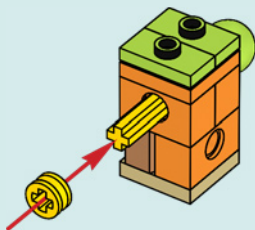

1x

8

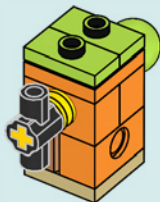

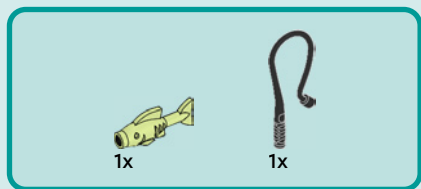

9

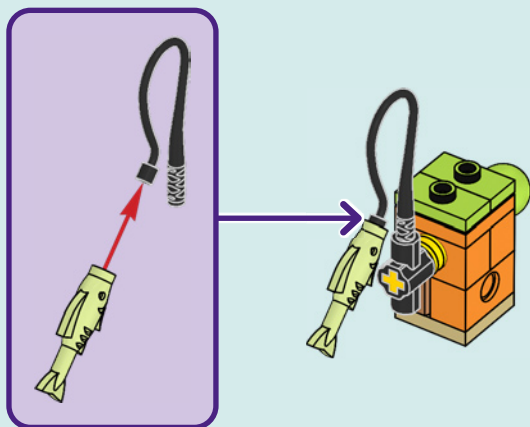



1x

10

CHURRO

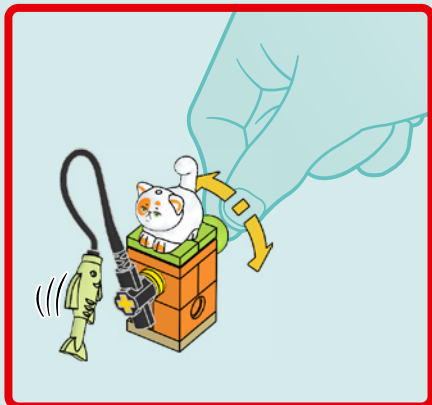

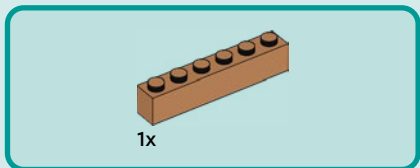

1

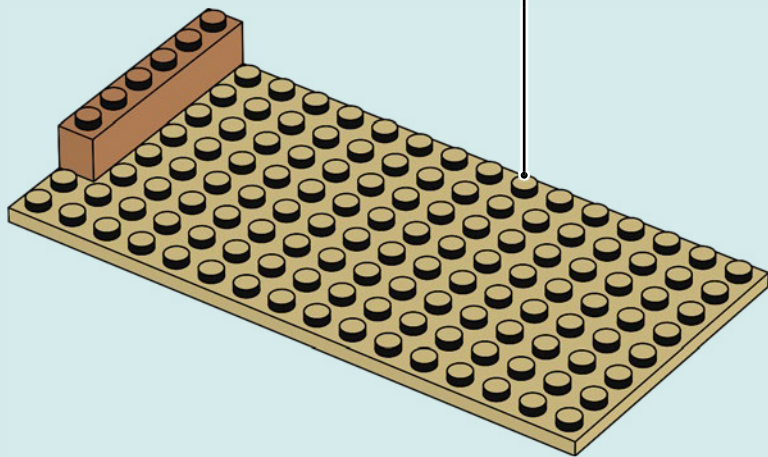



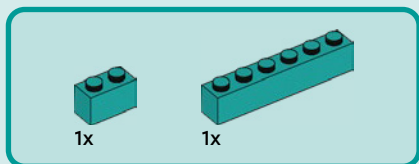

2

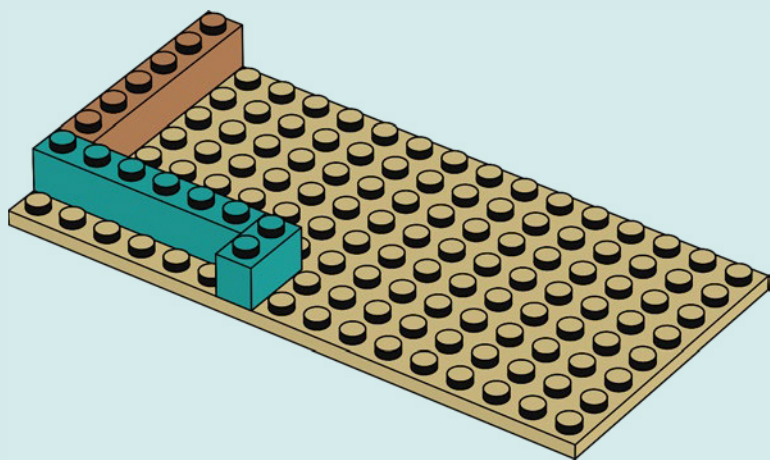



1x



2x

3

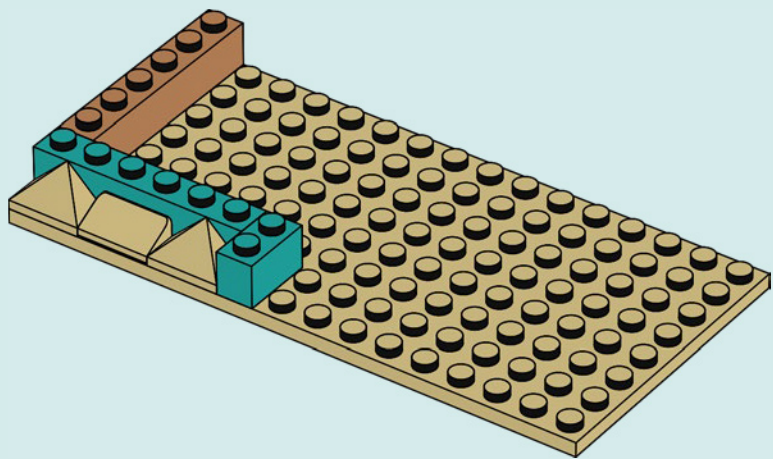

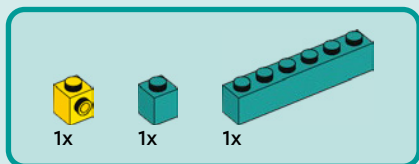

4

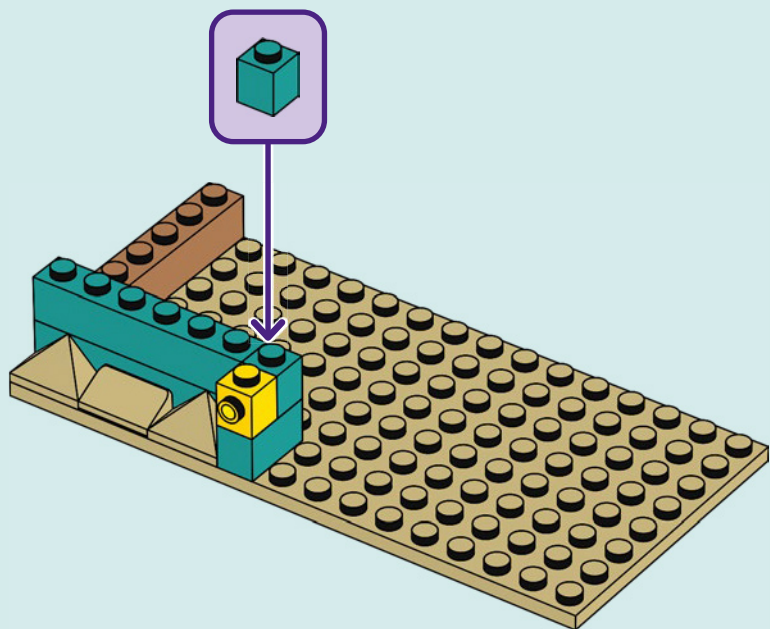

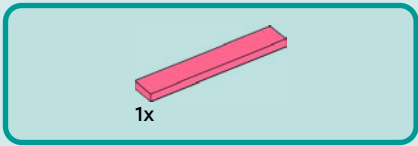

5

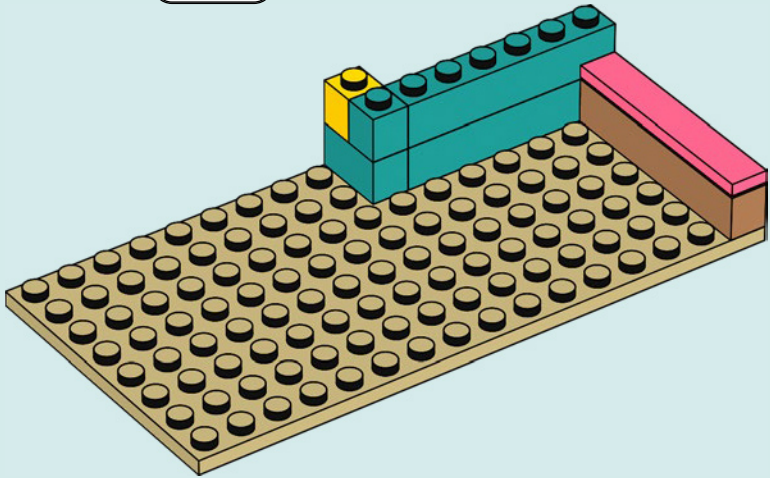



2x

6

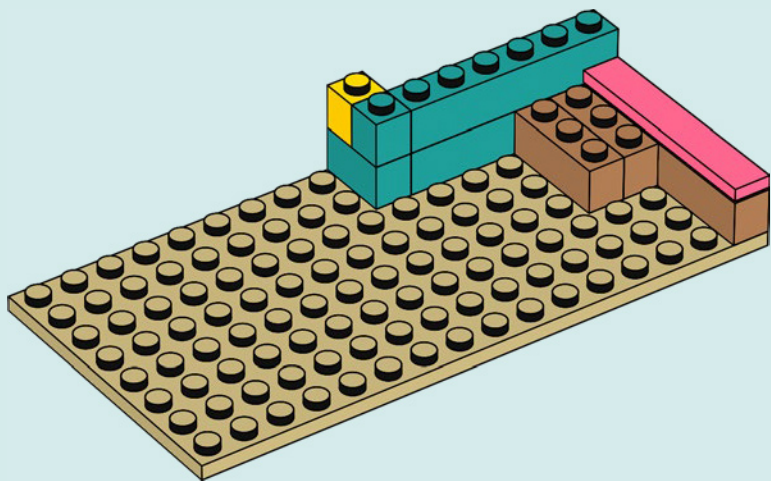

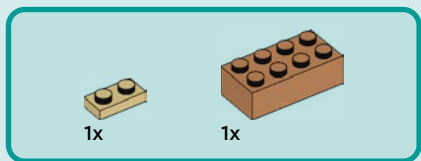

7

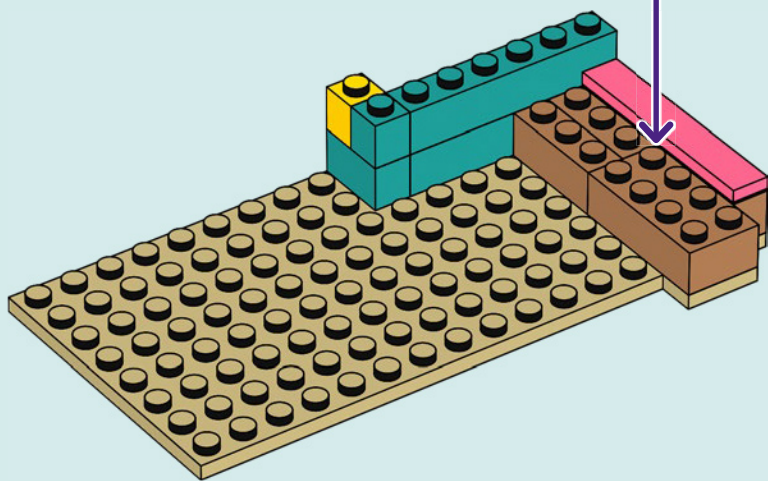
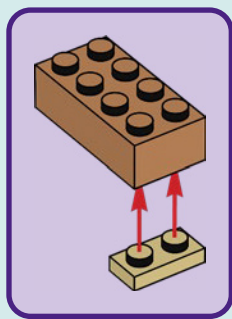



1x



1x



1x

8

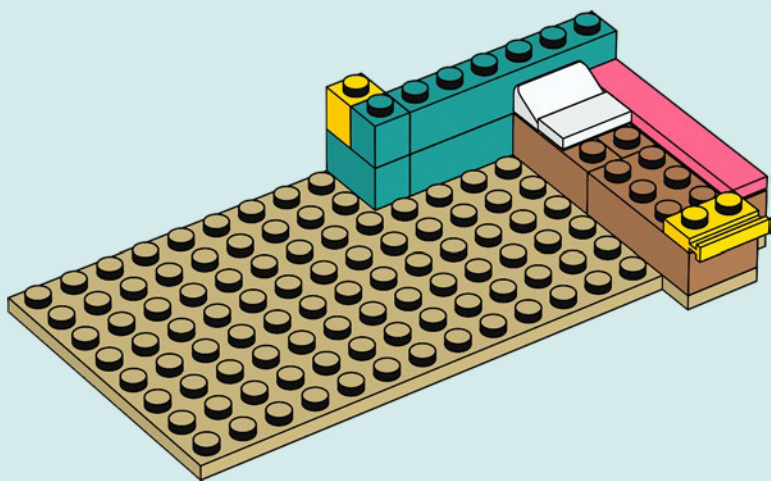

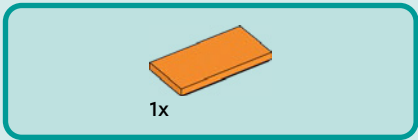

9

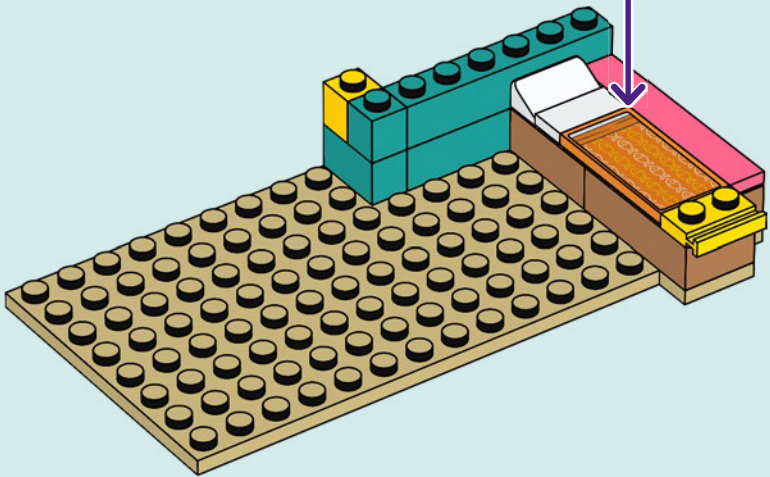
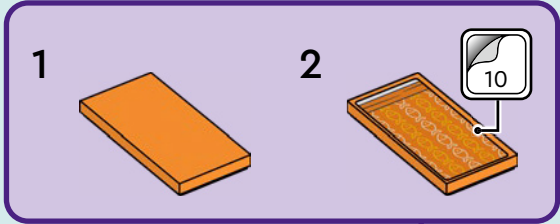



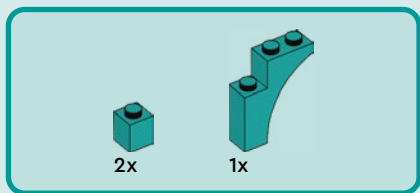

10

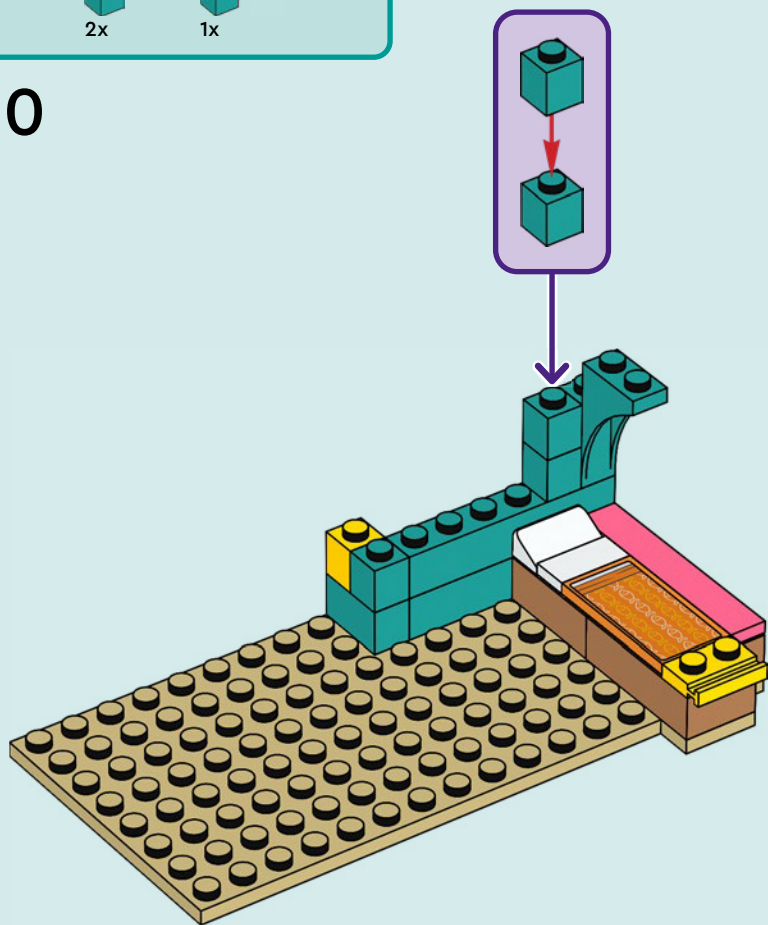

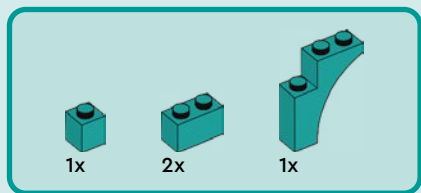

11

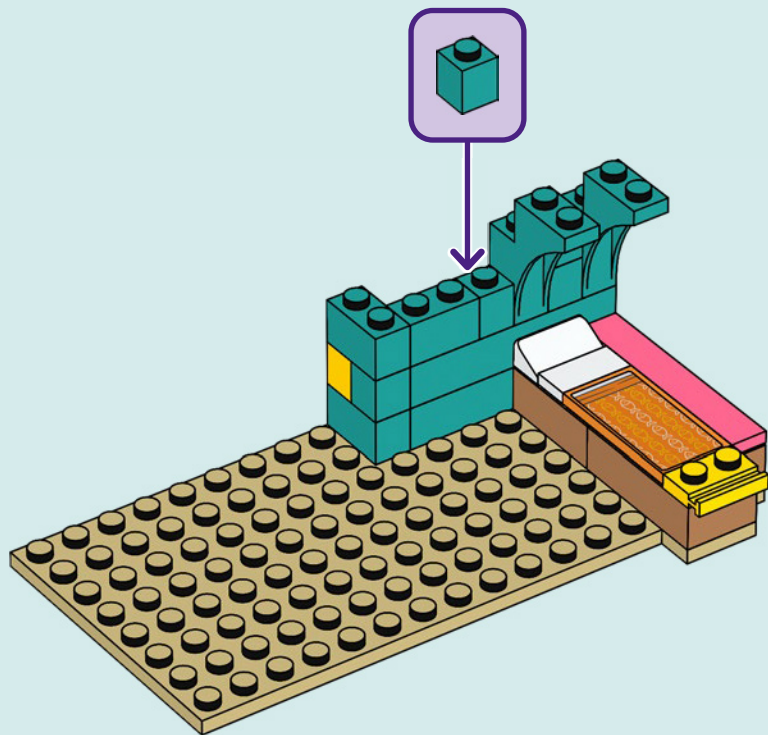



1x



2x

# 12

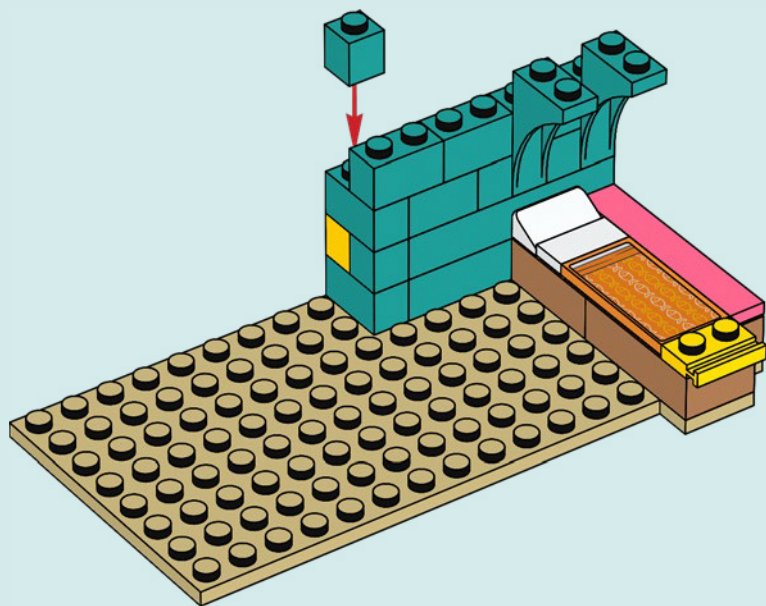

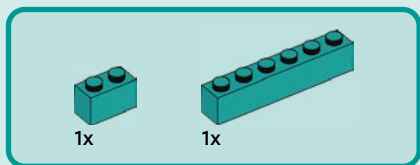

13

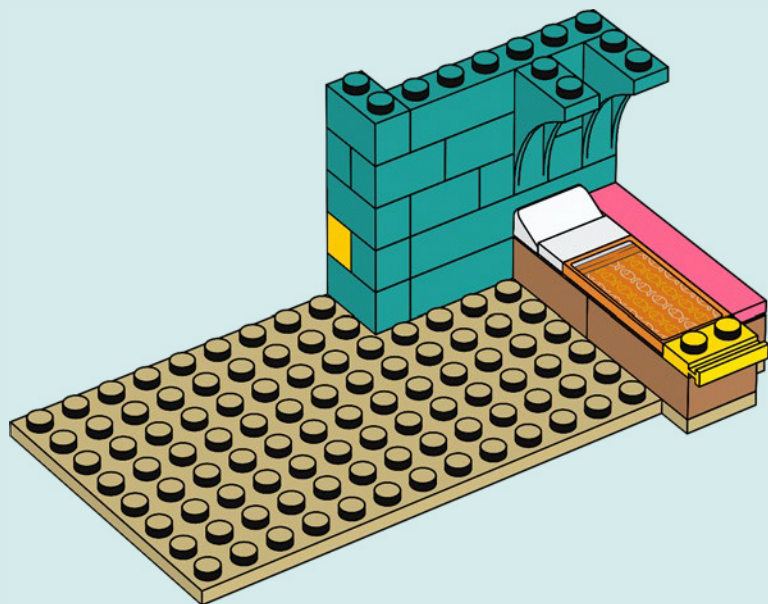

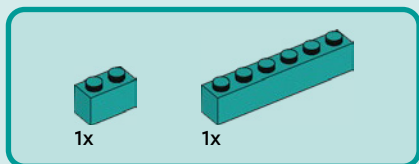

14

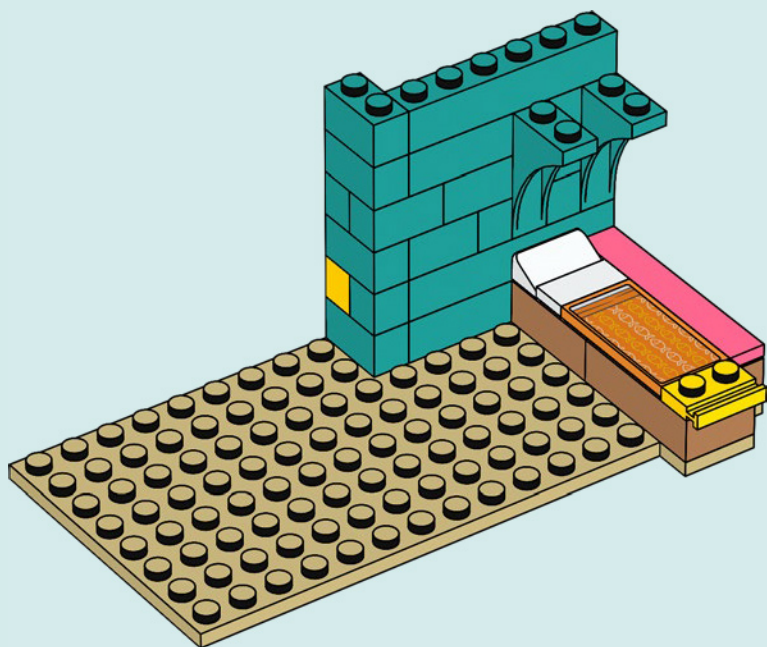

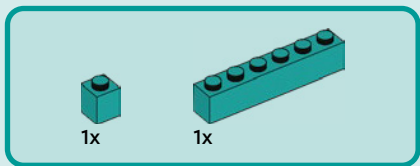

15

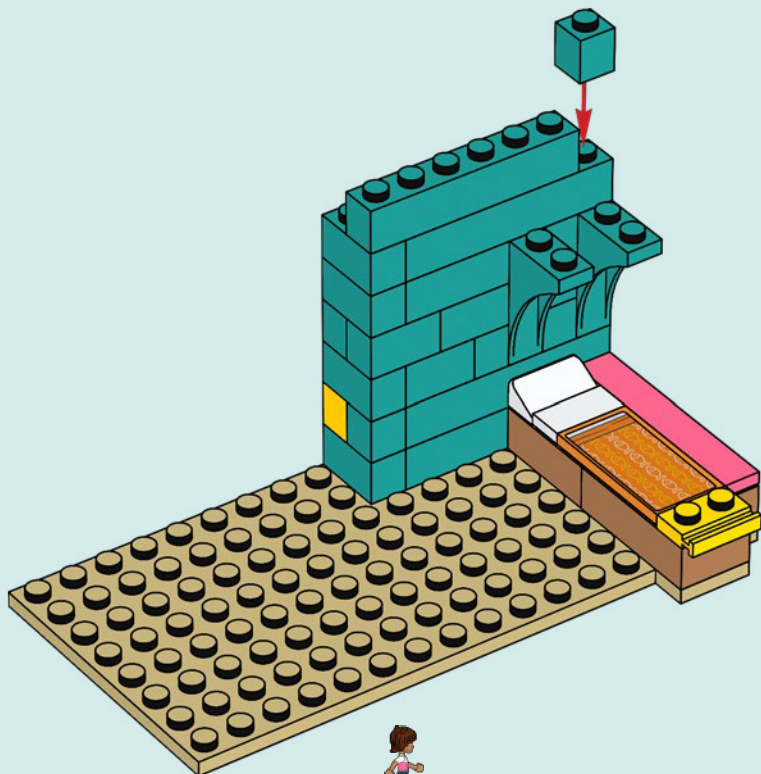



2x



2x

16

1

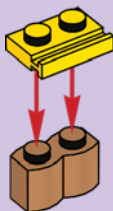

2

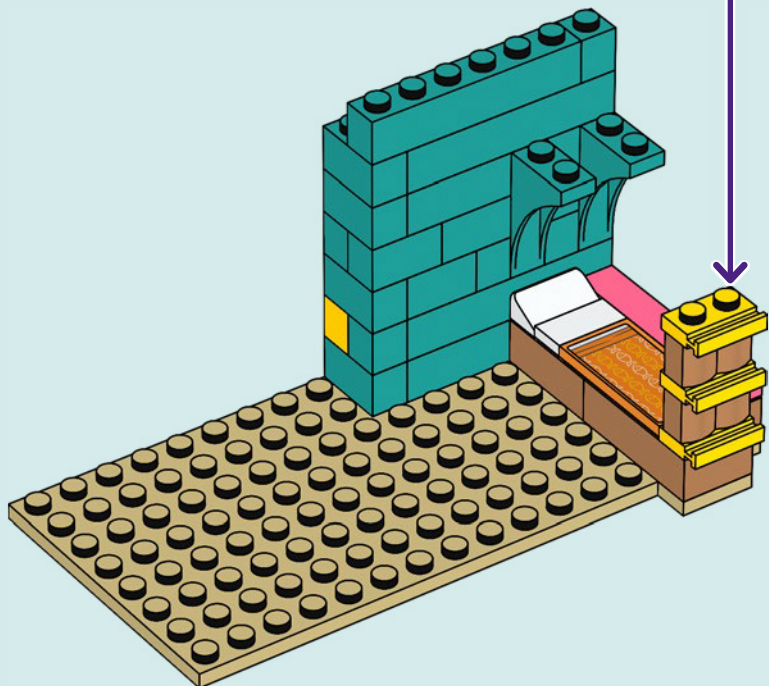
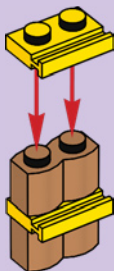

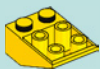

1x

17

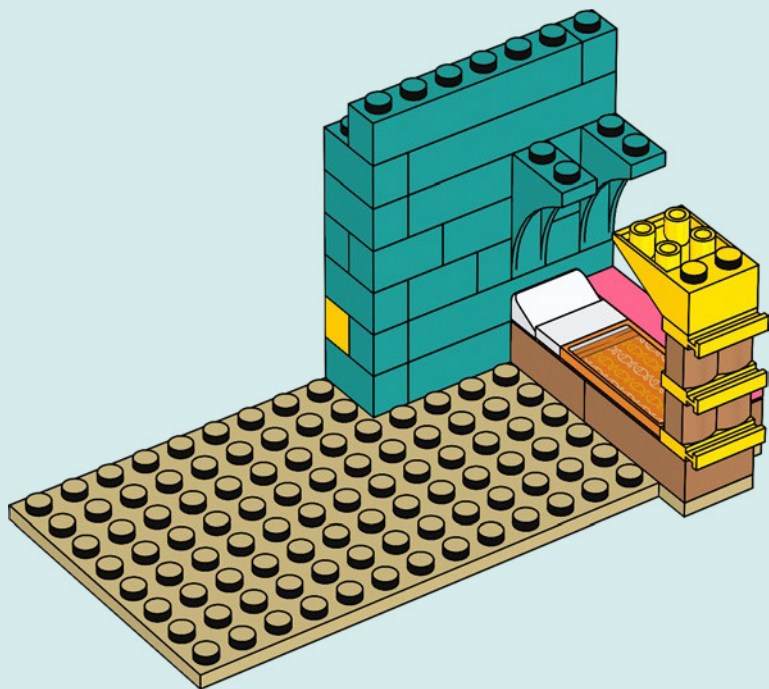



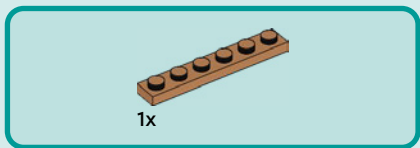

18

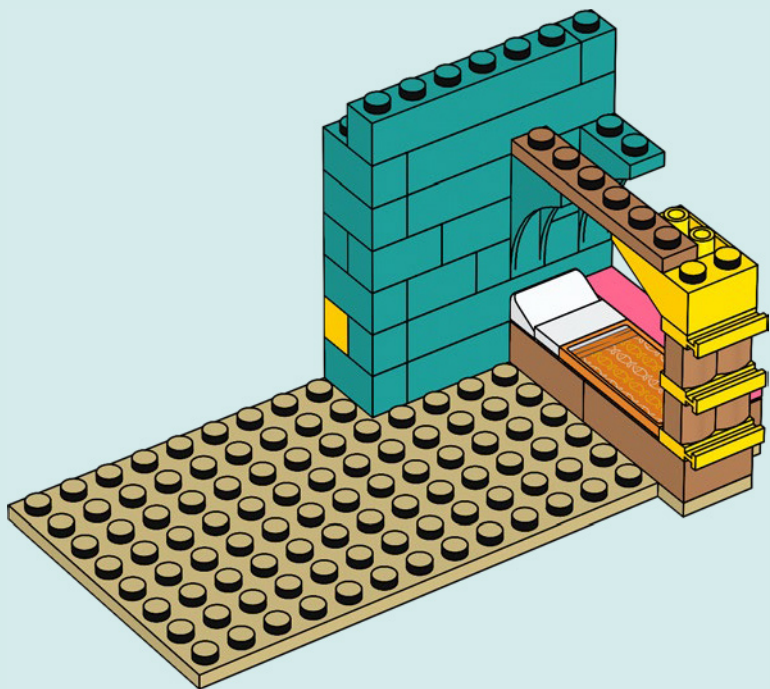



1x

19

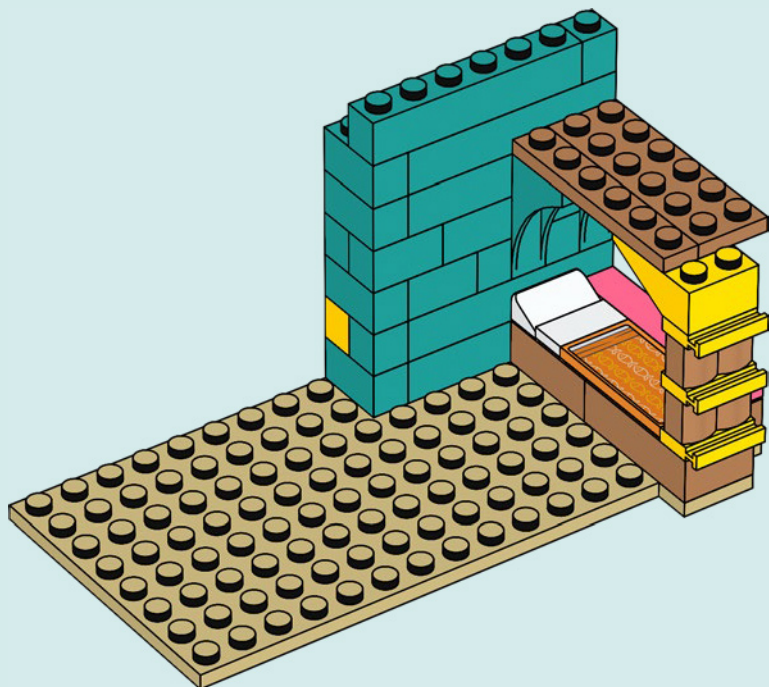



1x



1x

# 20

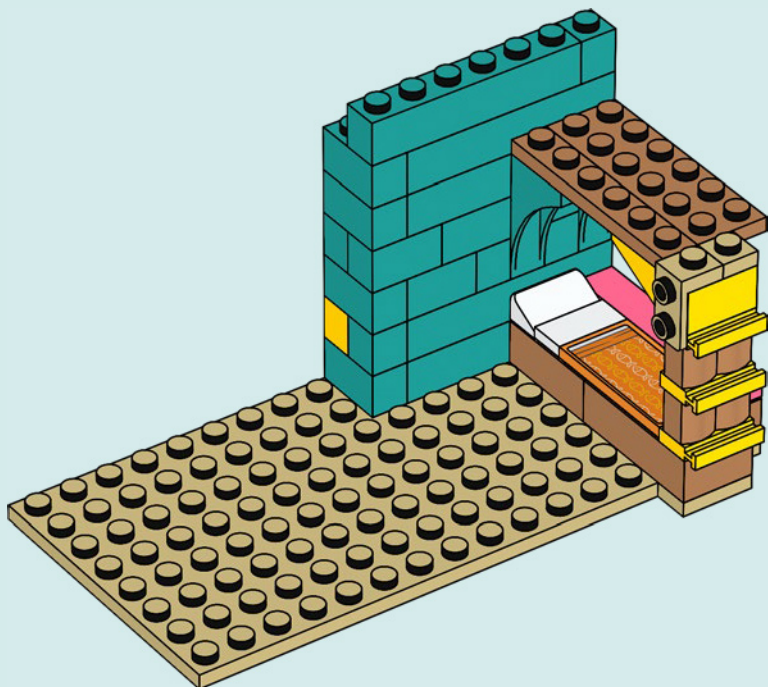

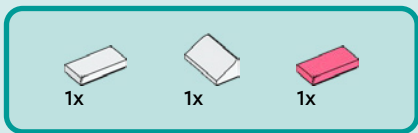

# 21

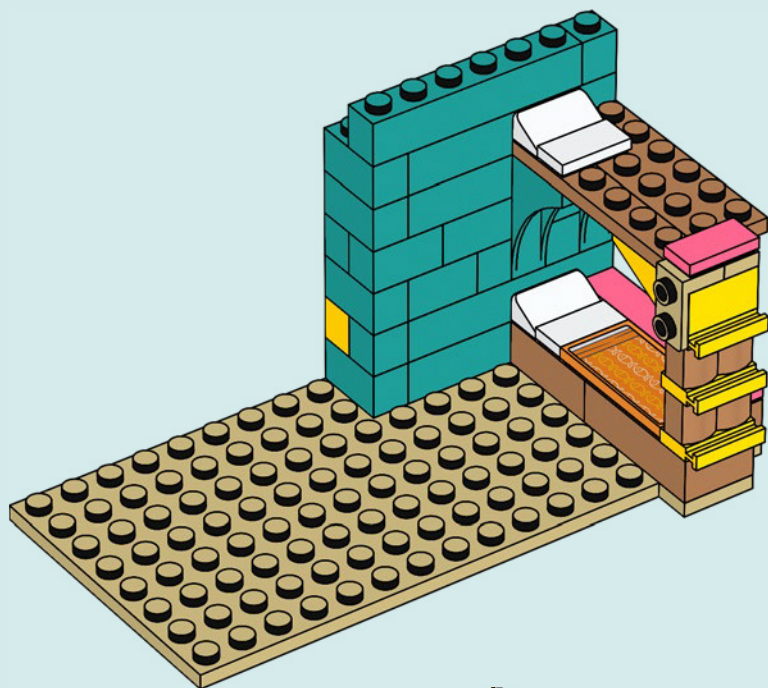

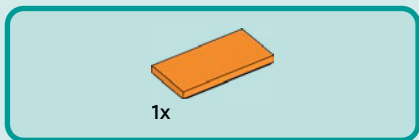

22

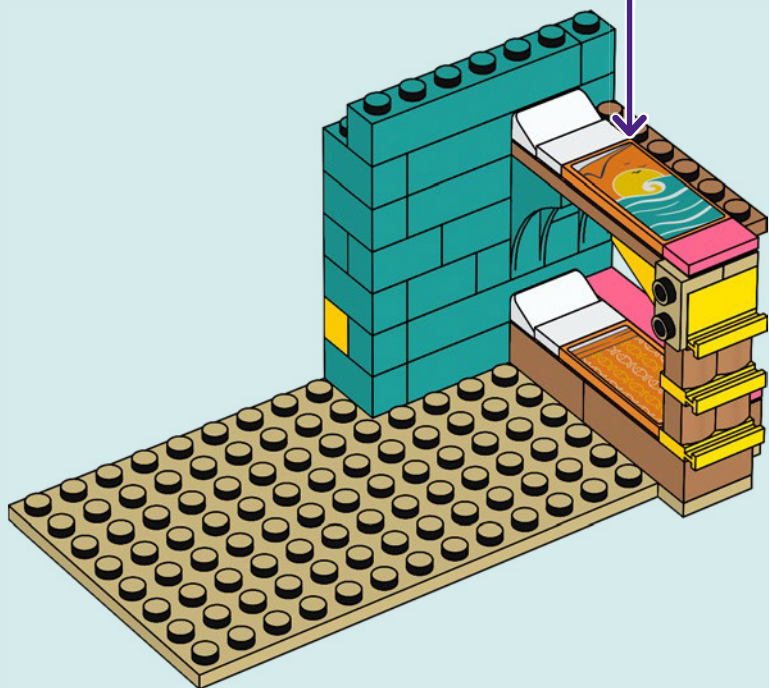
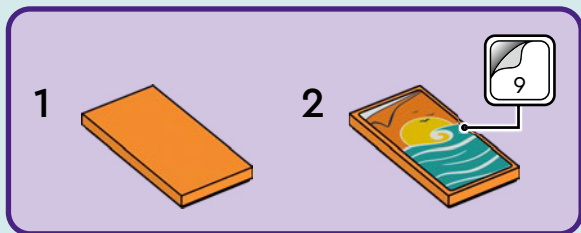



3x

# 23

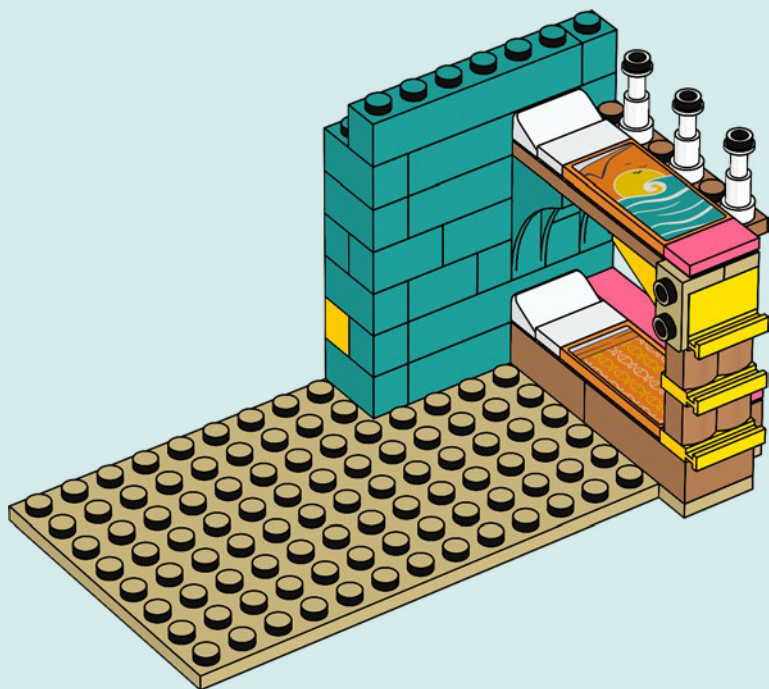

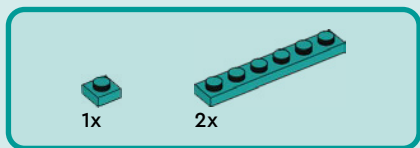

24

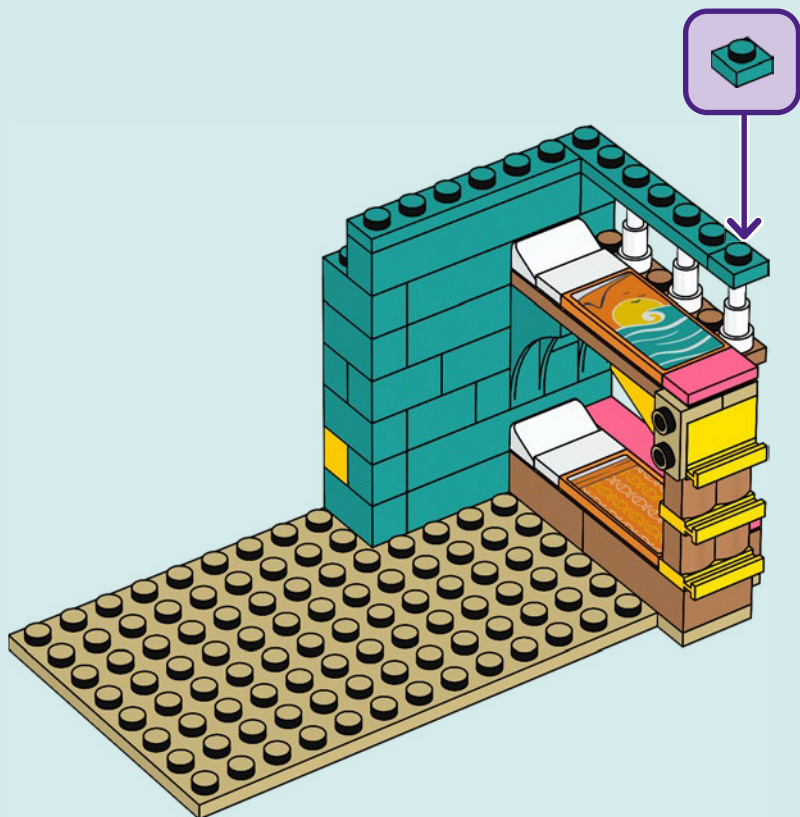



2x

25

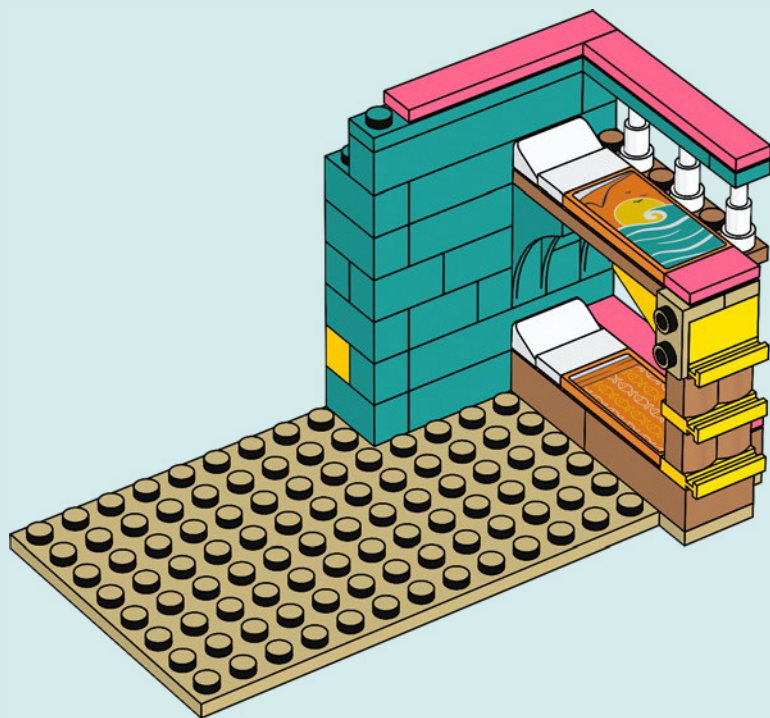





1x

26

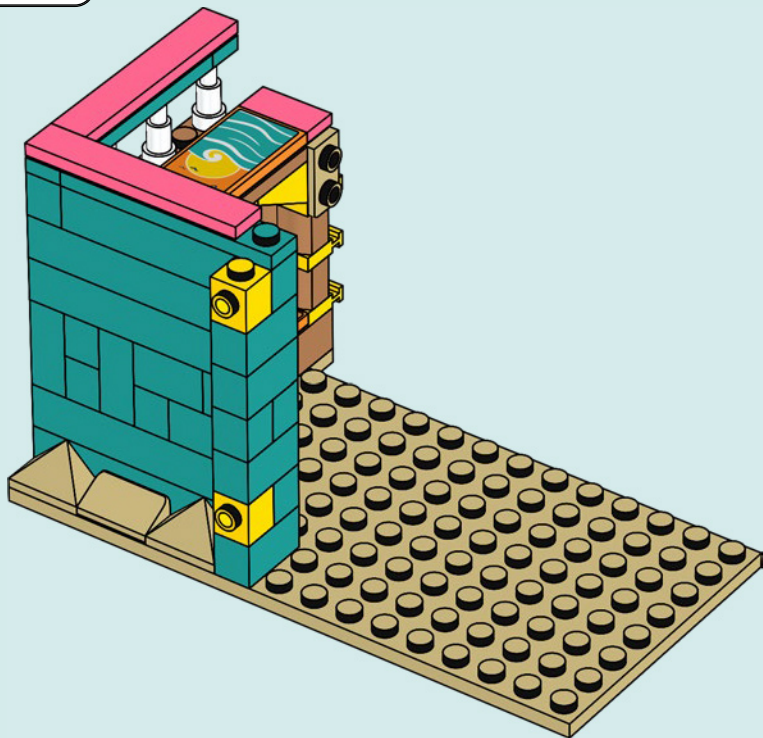

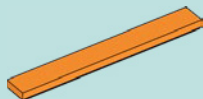

1x

27

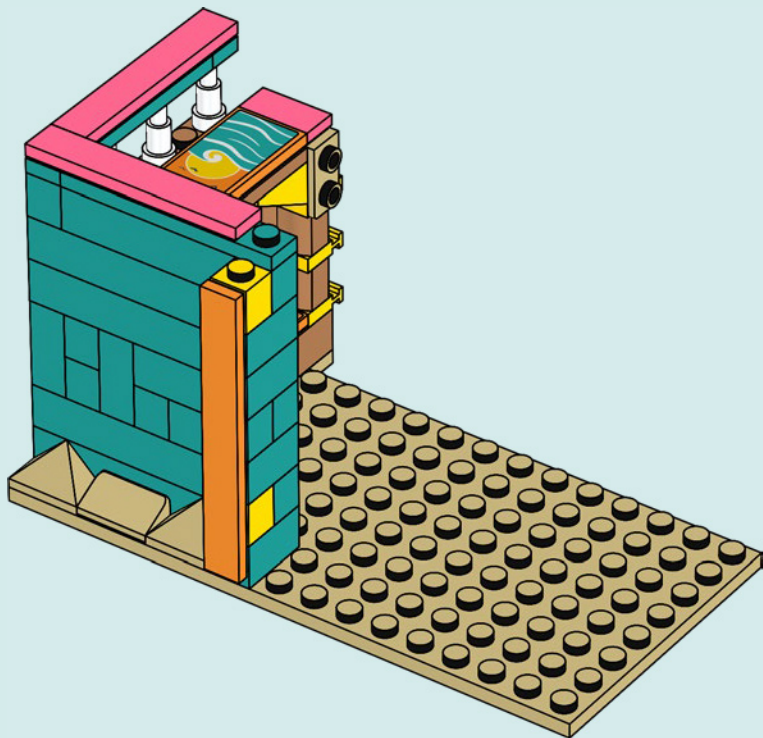

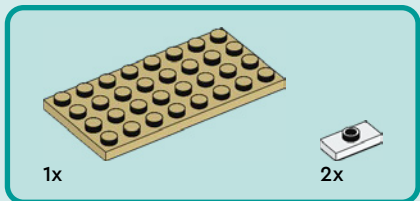
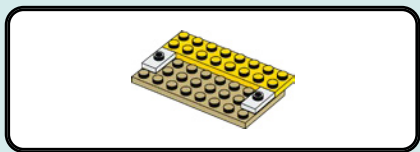

28

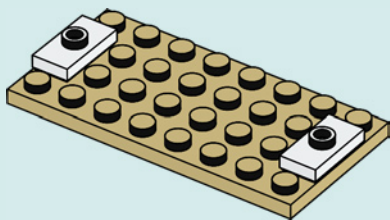

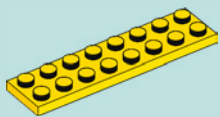

1x

29

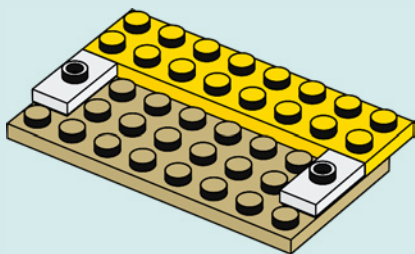

30

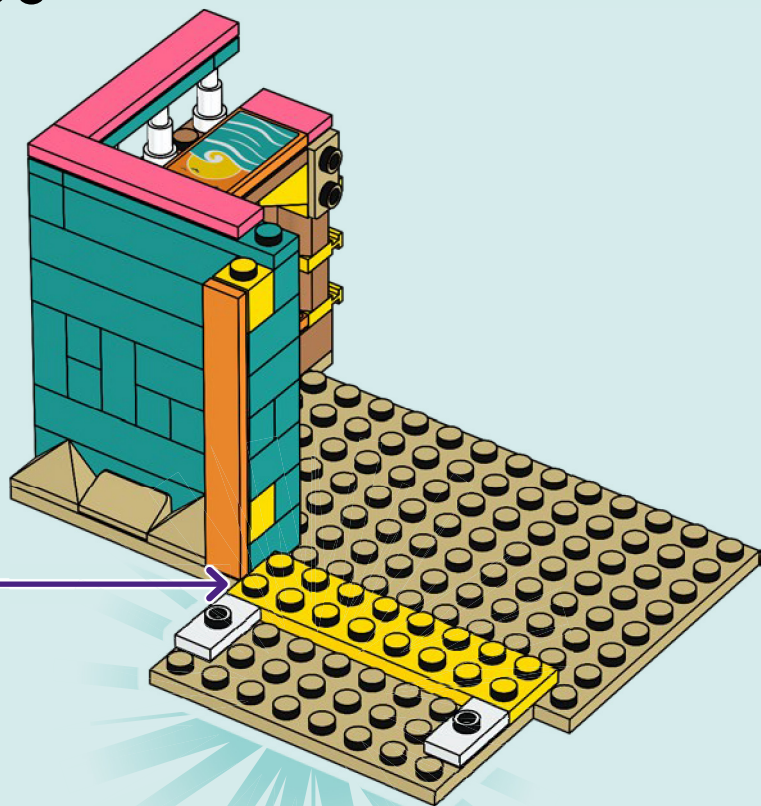

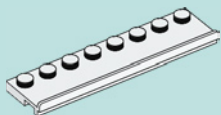

1x

31

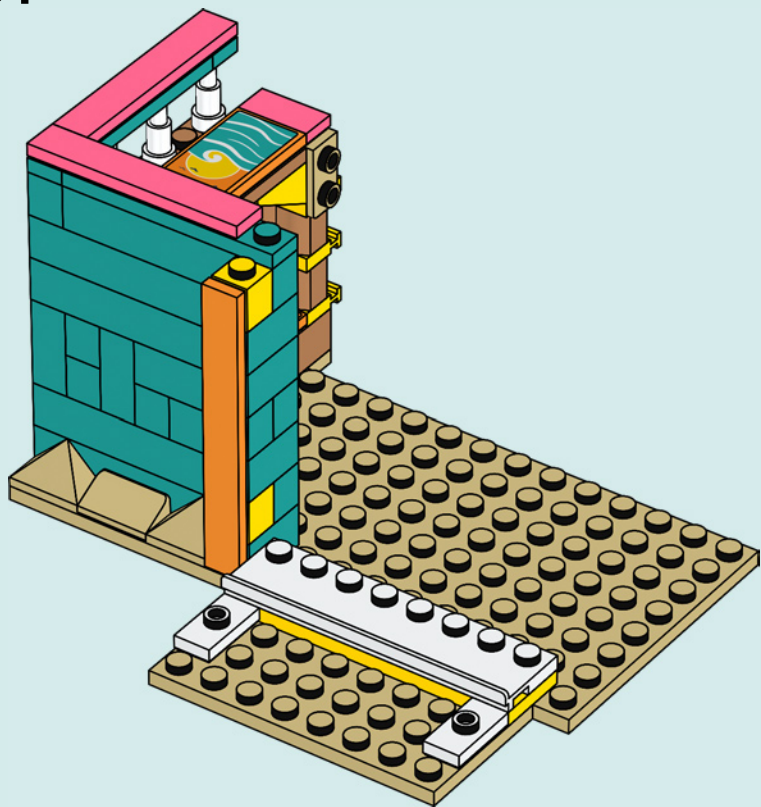



1x

32

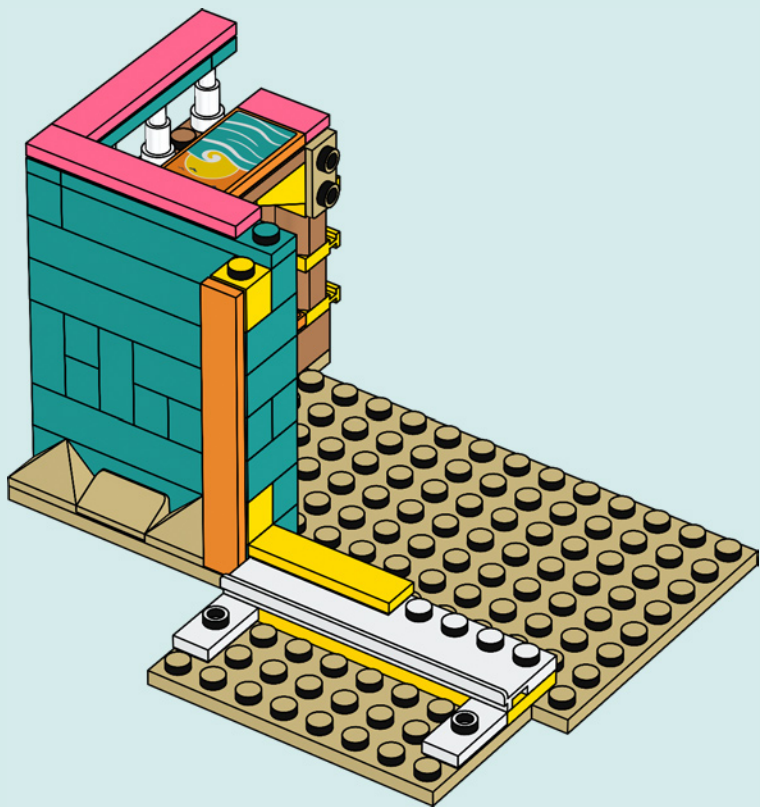

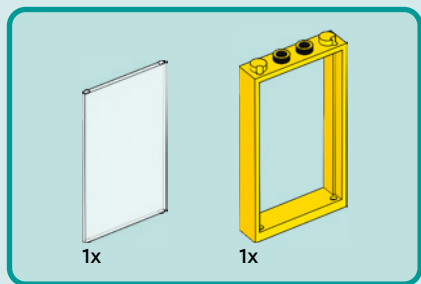

# 33

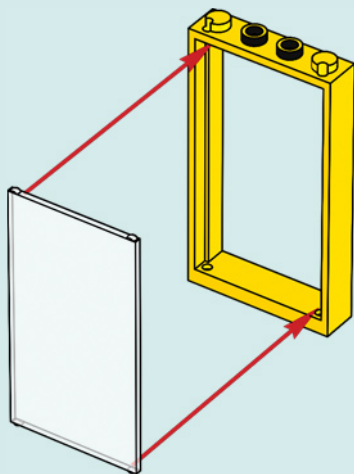



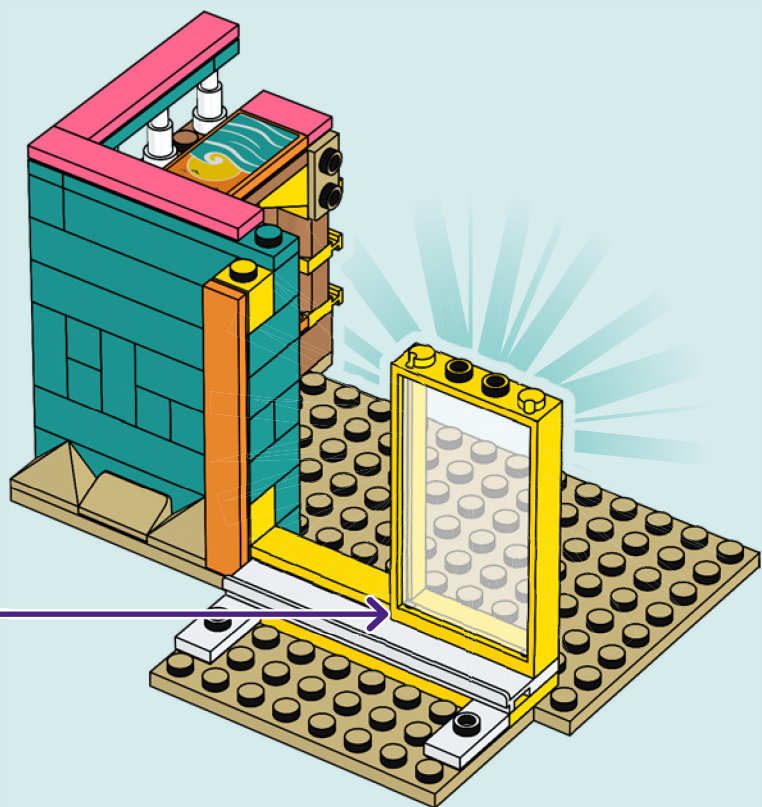



1x



1x

# 34

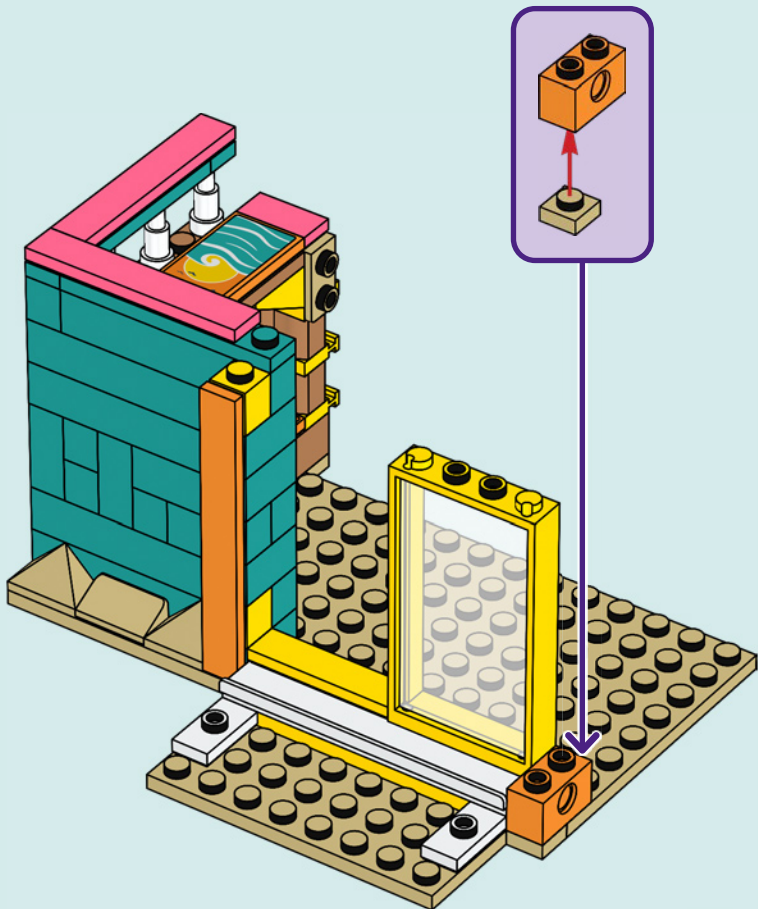



3x

35

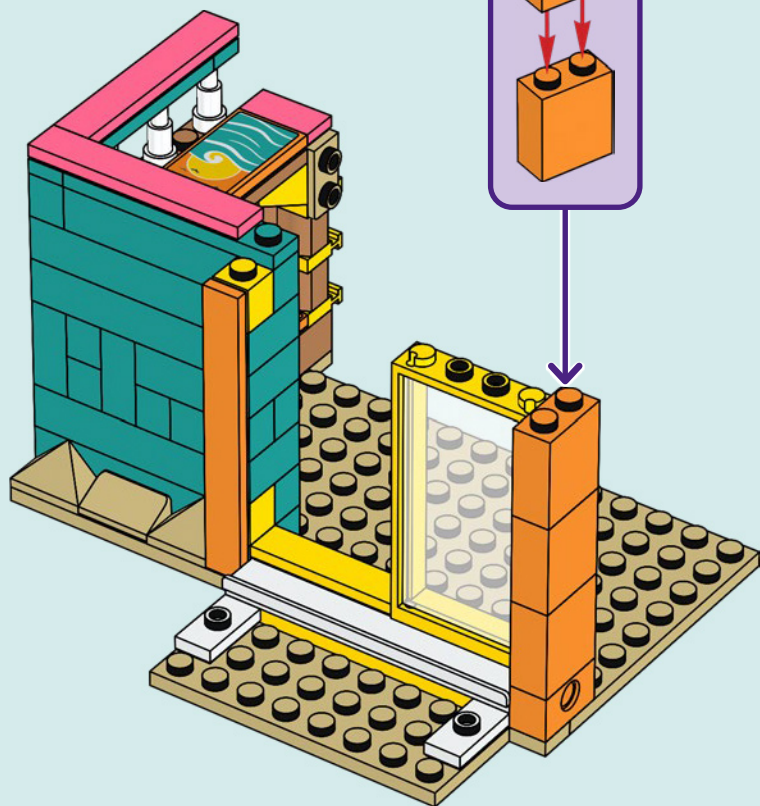

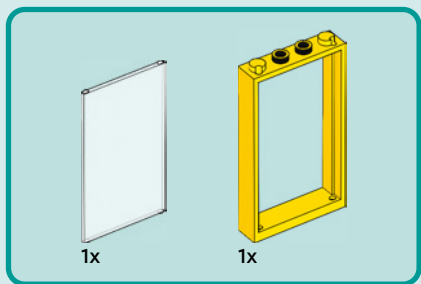

36

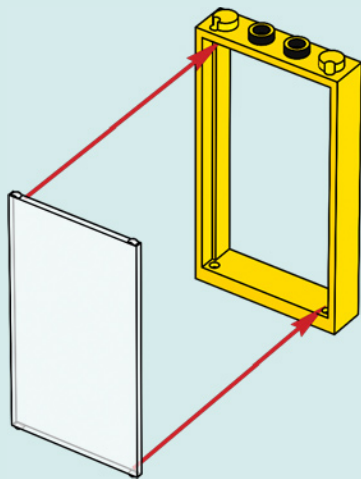

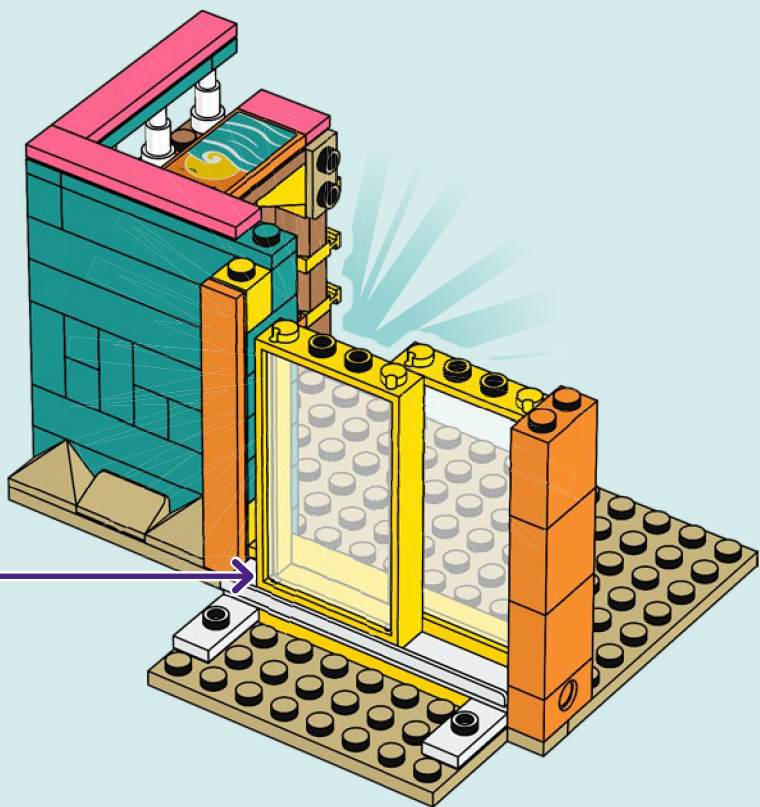

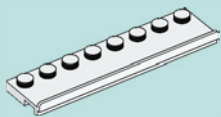

1x

# 37

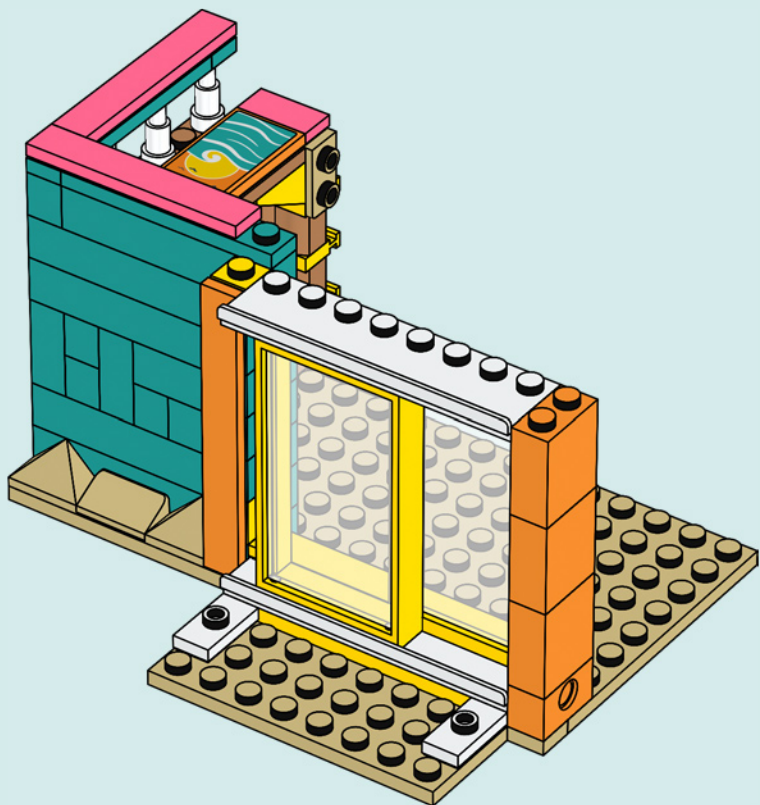



1x

# 38

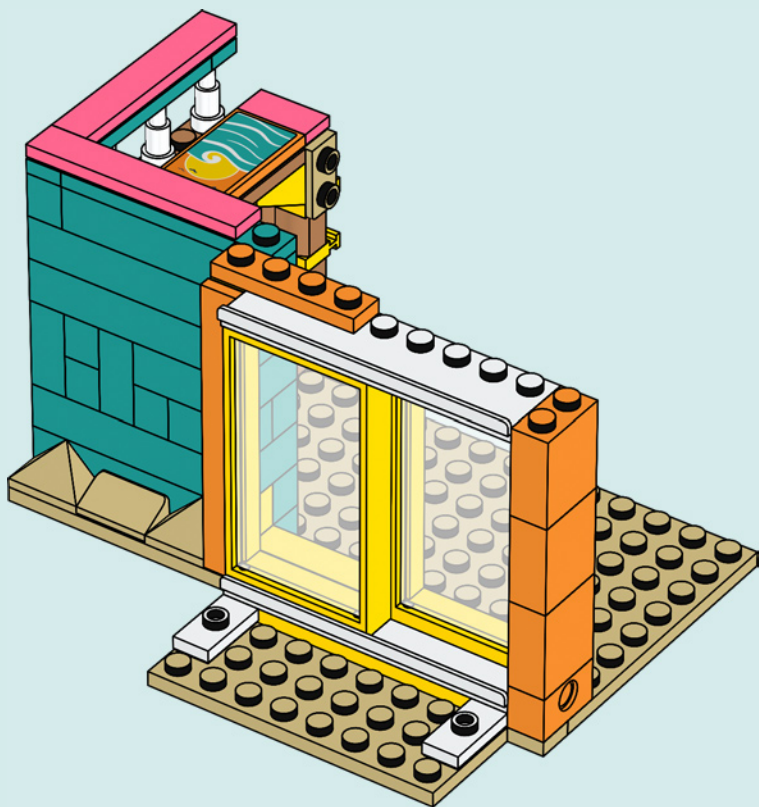



1x



1x

# 39

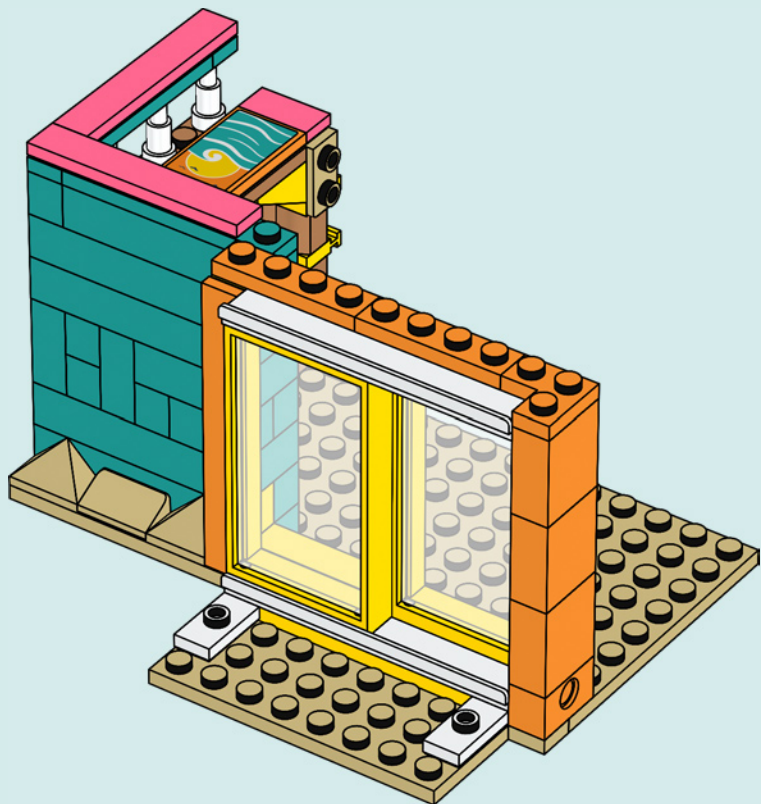



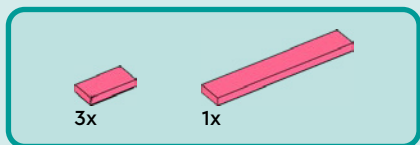

40

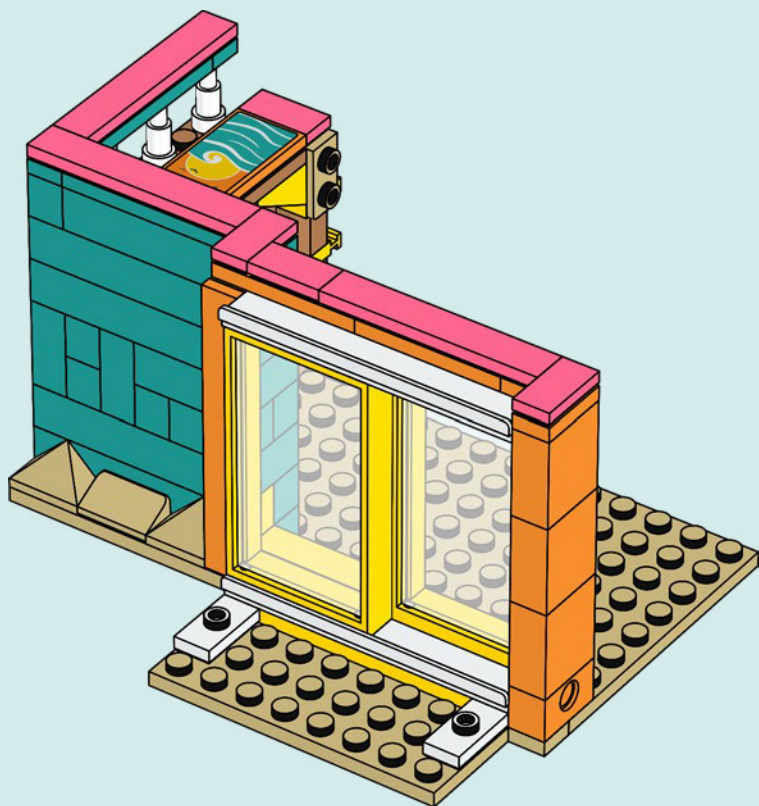

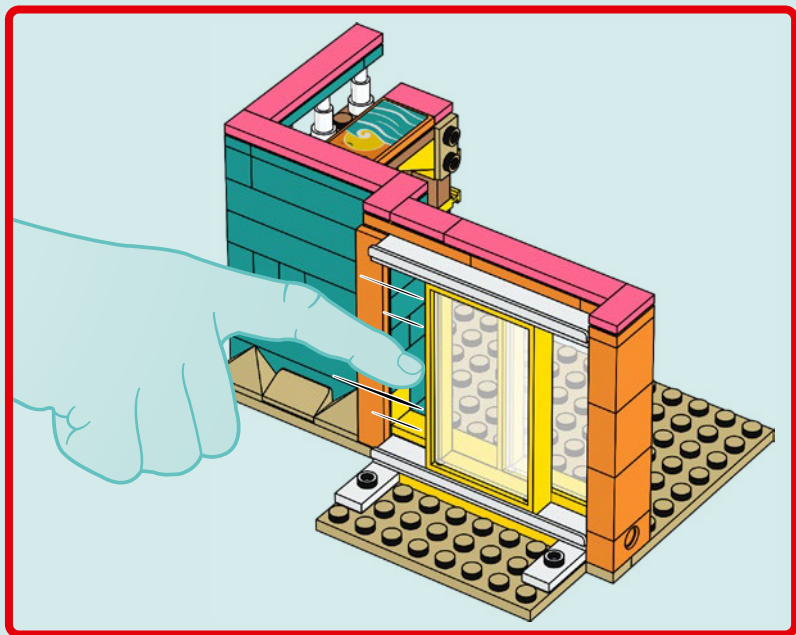



1x

# 41

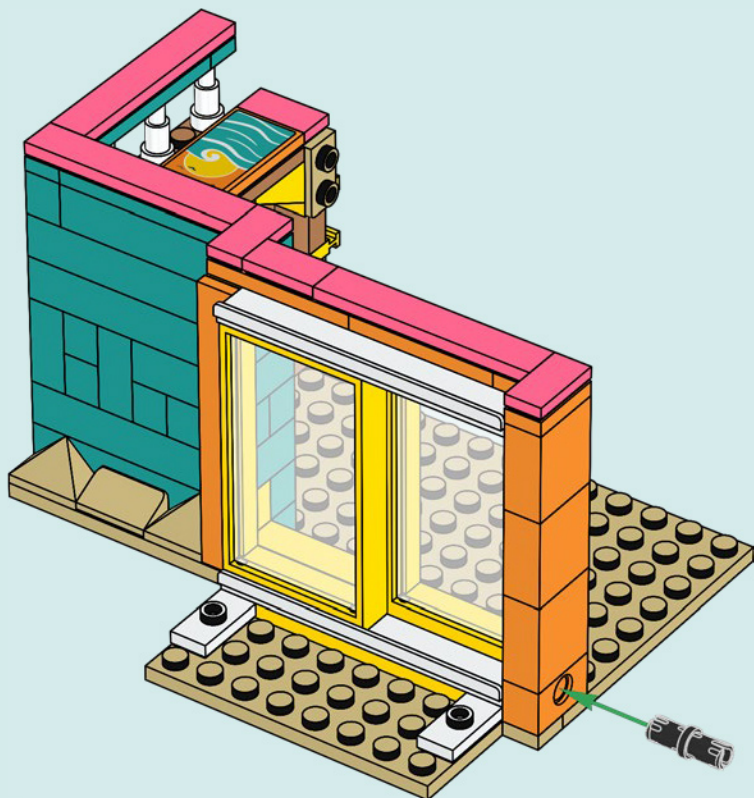



2x

42

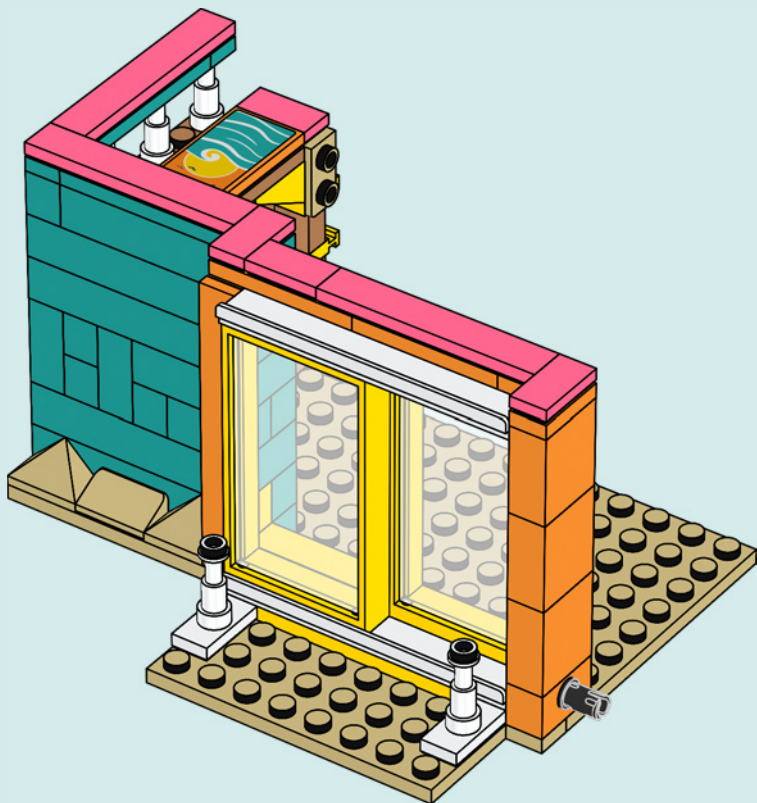

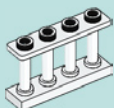

2x

# 43

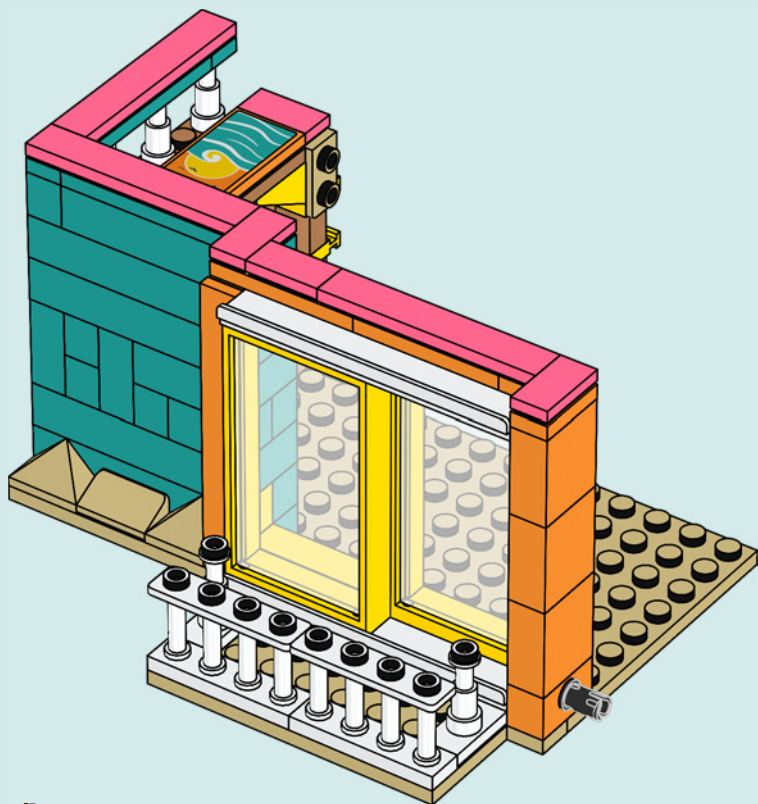



2x

44

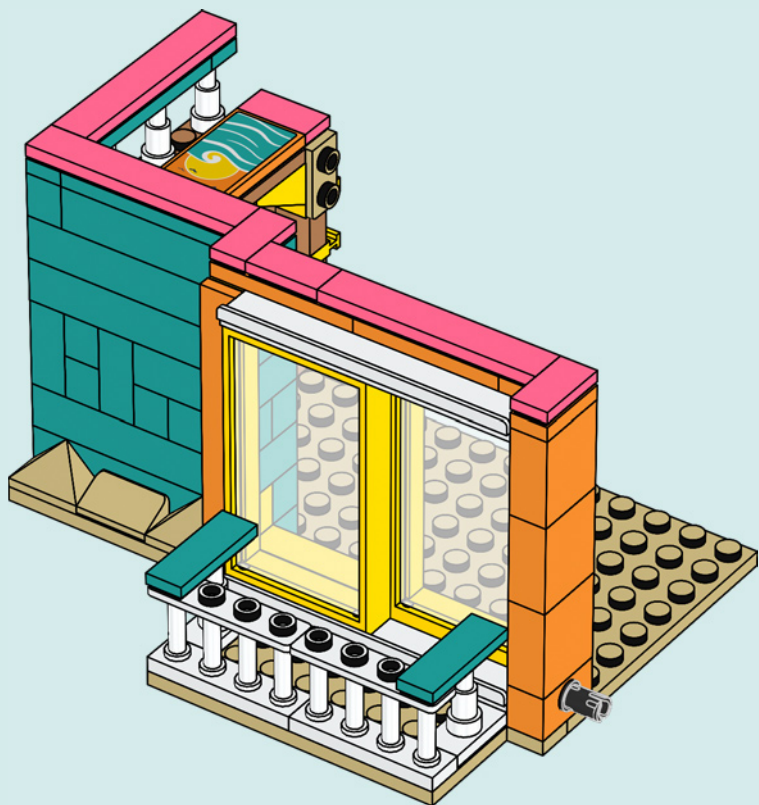



3x

# 45

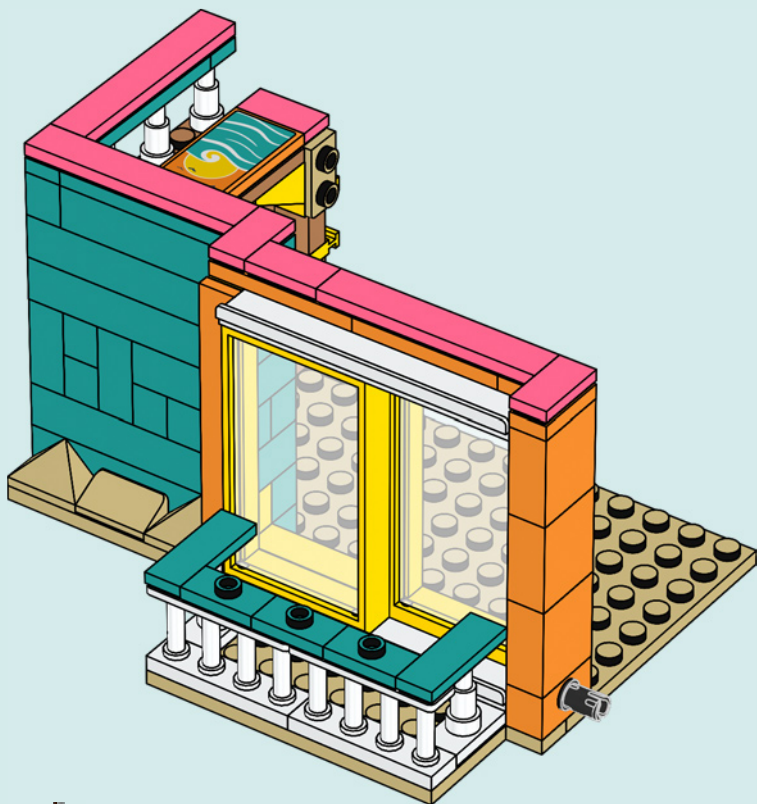



1x



1x

46

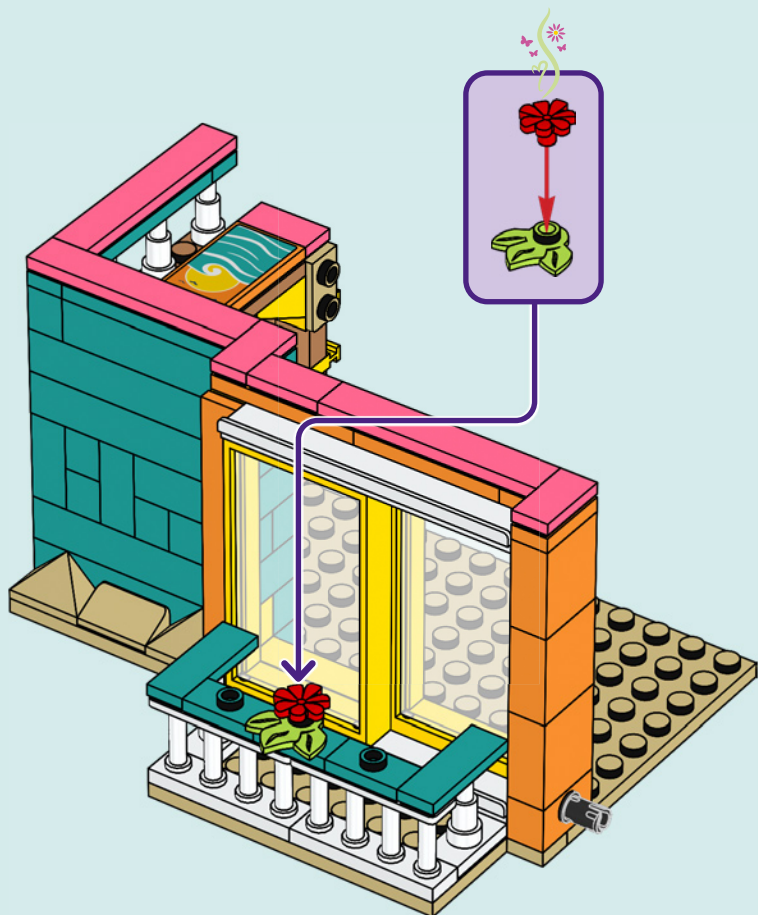





1x



1x

47





1x



1x

# 48





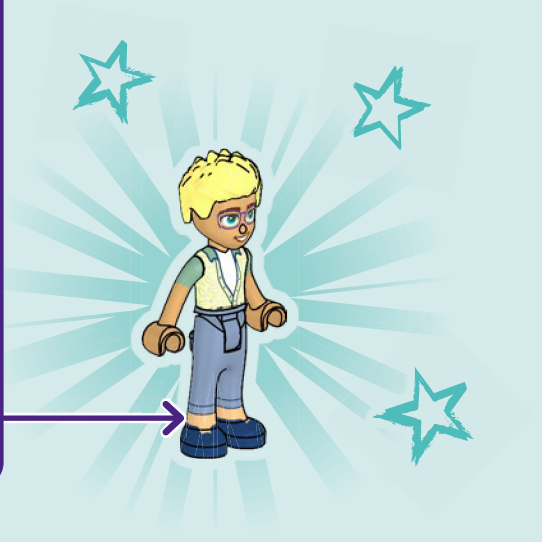
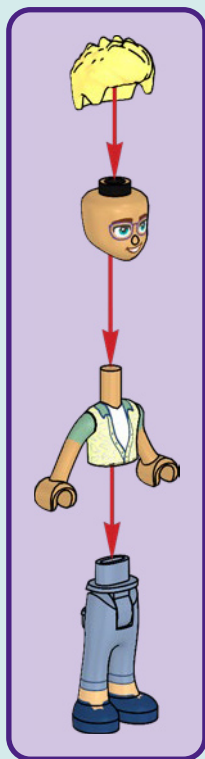

# OLLY





2x



2x

49



2x





1x



1x



2x



1x

# 50

1

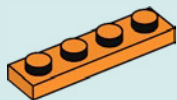

2

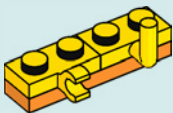

3



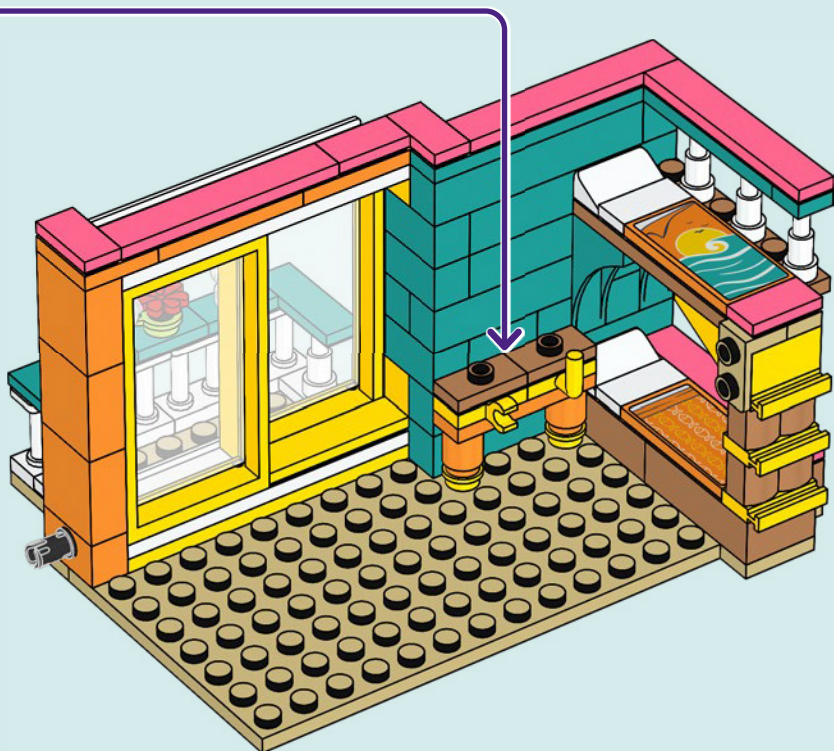





1x



1x



1x

# 51

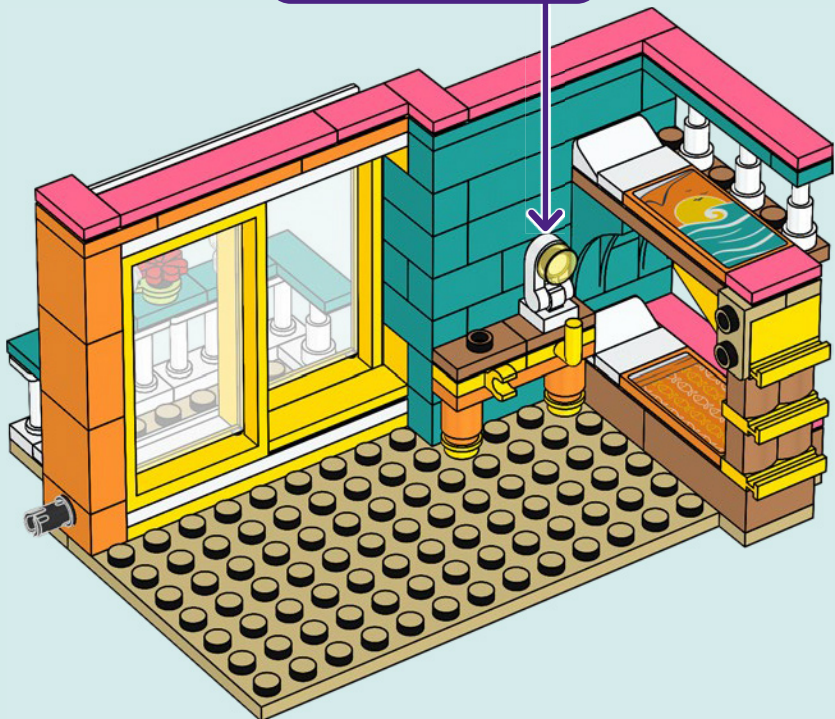
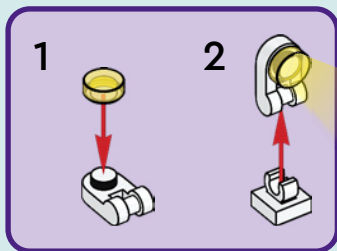



2x



1x

# 52

1



2

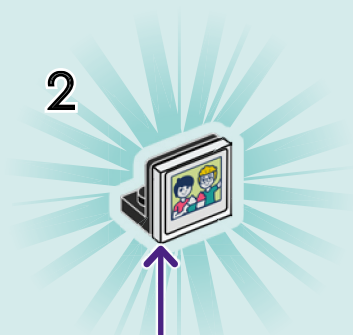

1



2



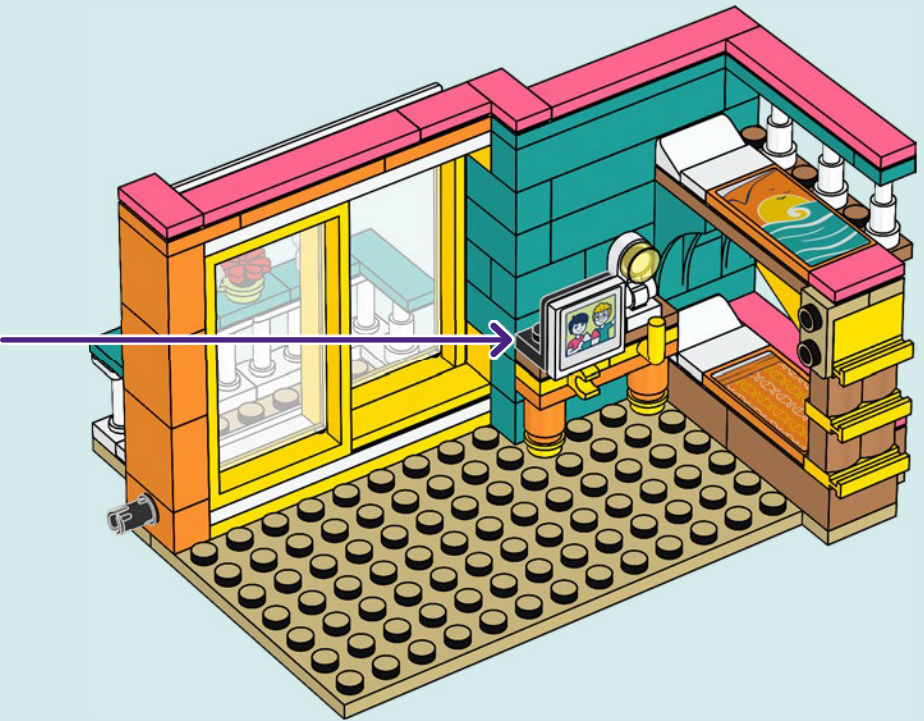
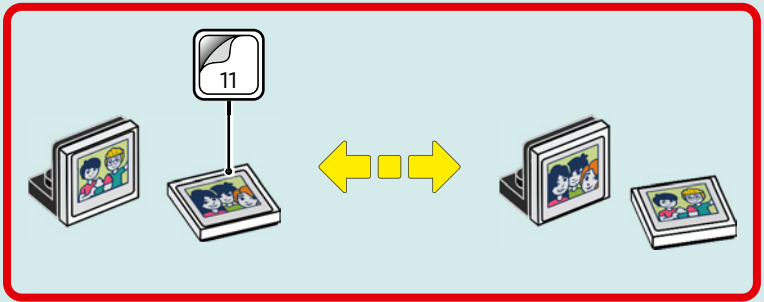



1x

# 53

1



2





1x



1x

# 54



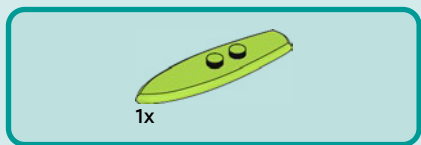

55

1

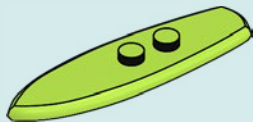

2

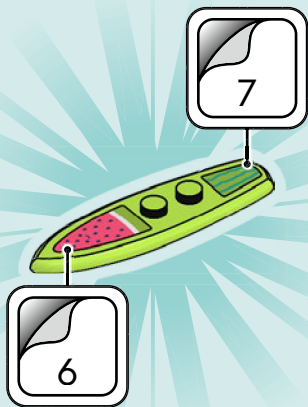





1x



1x



1x

# 56

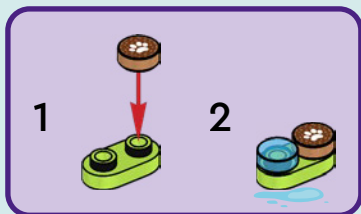





1x

57





1x



1x

# 58

1

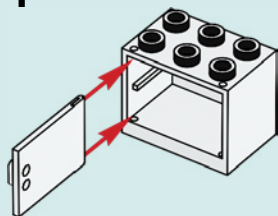

2







1x



1x



1x



1x

# 59

## 1

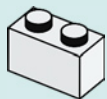

## 2

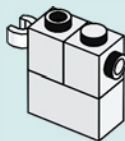

## 3

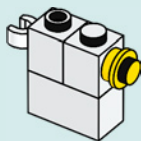





1x



1x

# 60





2x

61





2x

62







# 63

1

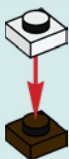

2



3



4

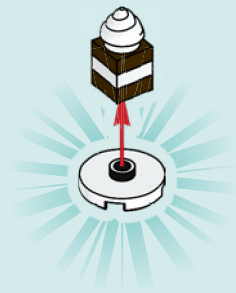

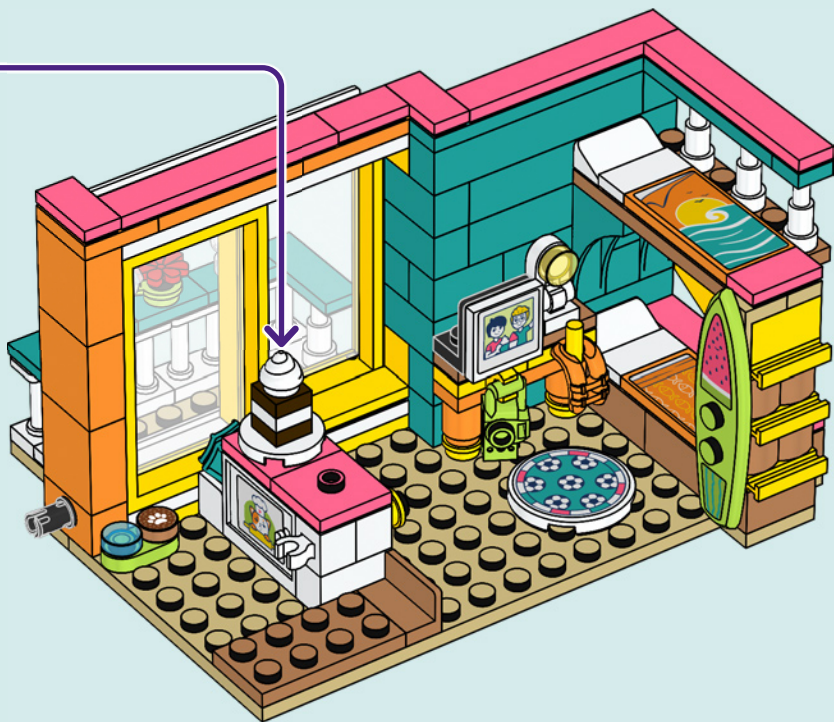



1x



1x

# 64





1x



1x

# 65





1x



2x

# 66

1



2





2x

67

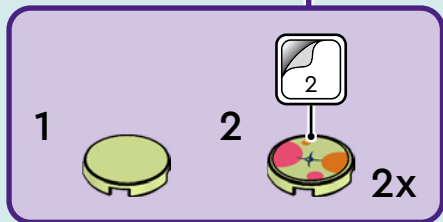

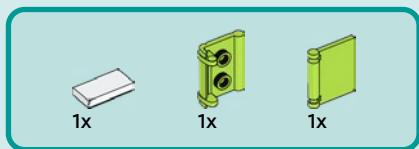

68

1

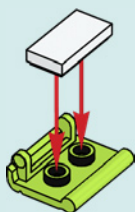

2

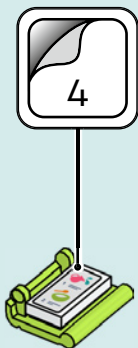

3

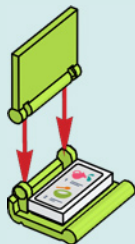

4

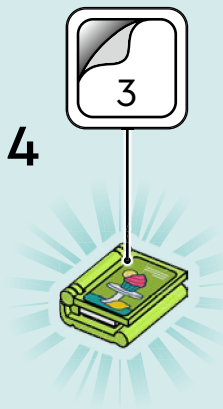





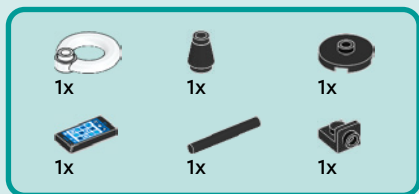

69

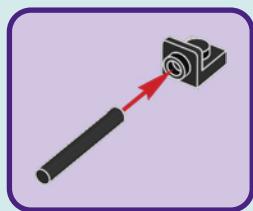

1



2

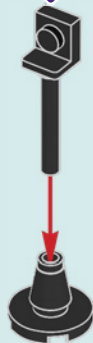

3



4

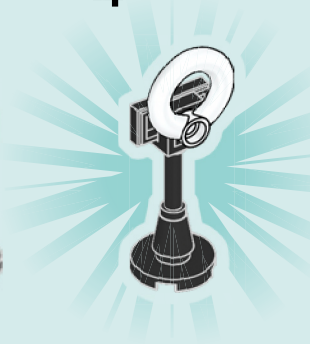



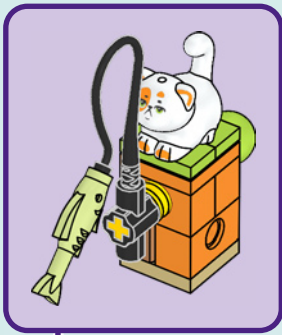

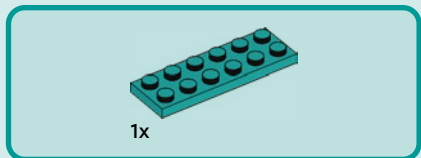

1

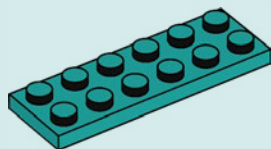



2x

2

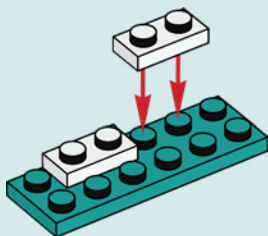

2x

3

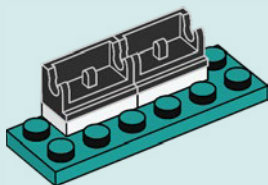



2x

4

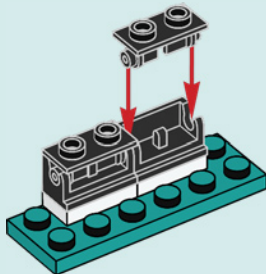

1x

5

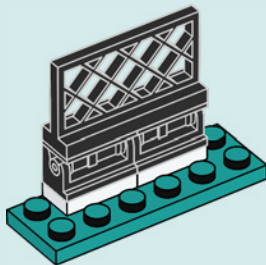

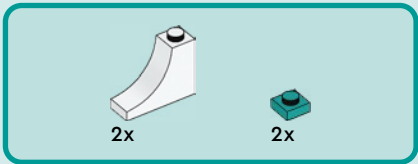

6

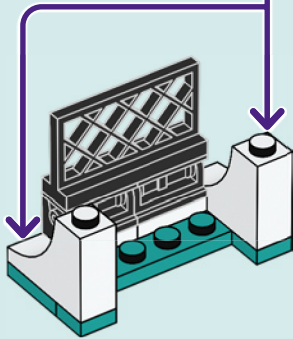
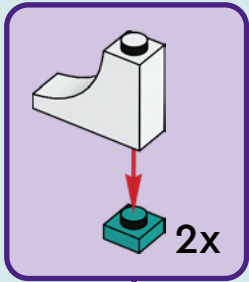

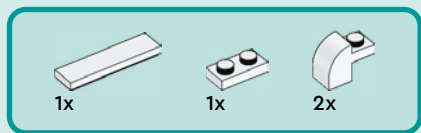

7

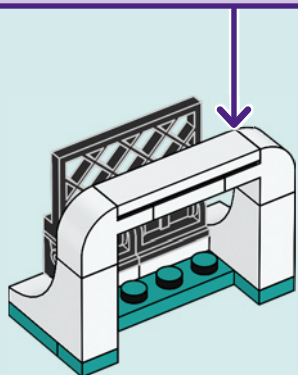
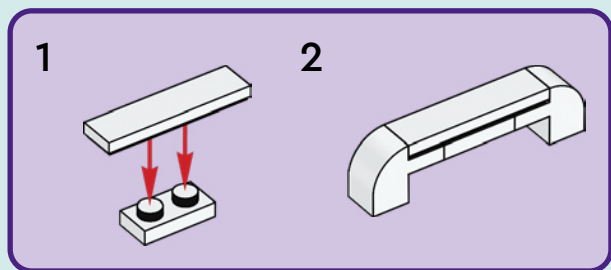



8

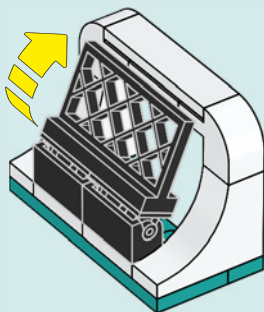



9

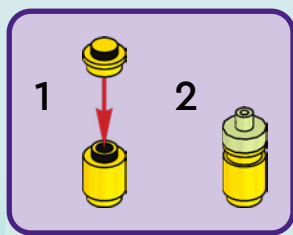
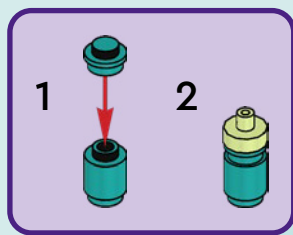

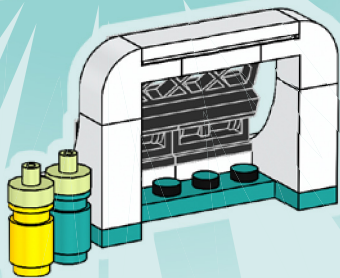



# Friends

PAISLEY

AUTUMN

ALIYA

ZAC



LEO

LIANN

OLLY



NOVA



# Friends

41727



41741

41738



41730





# Friends

41731









41728



41743





  
 1x  
 6292800  
  
 1x  
 4558952  
  
 2x  
 302401  
  
 1x  
 6348055  
  
 1x  
 6198979  
  
 1x  
 6321349  
  
 1x  
 6174310  
  
 1x  
 6174937  
  
 2x  
 4547489  
  
 1x  
 6093053  
  
 1x  
 6428858  
  
 3x  
 302301  
  
 2x  
 6285777  
  
 2x  
 6051511

  
 1x  
 300401  
  
 1x  
 6248490  
  
 3x  
 306901  
  
 6x  
 6070327  
  
 1x  
 4261470  
  
 1x  
 4297083  
  
 2x  
 306801  
  
 1x  
 6300017  
  
 2x  
 6110019  
  
 1x  
 4619665  
  
 1x  
 243101  
  
 2x  
 6047813

  
 2x  
 4500878  
  
 1x  
 6182260  
  
 2x  
 6271167  
  
 4x  
 614124  
  
 1x  
 306224  
  
 2x  
 4624985  
  
 1x  
 6261356  
  
 1x  
 6313121  
  
 3x  
 4141630  
  
 1x  
 374724  
  
 1x  
 243124  
  
 2x  
 6262947

  
 1x  
 6130008  
  
 1x  
 303424  
  
 2x  
 6220715  
  
 1x  
 6136310  
  
 1x  
 6295184  
  
 1x  
 6261264  
  
 4x  
 6136553  
  
 3x  
 6078590  
  
 1x  
 4159007  
  
 1x  
 6106027  
  
 3x  
 4118782  
  
 2x  
 4648853

5

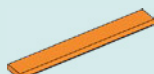

1x  
6343067



1x  
4529236



1x  
6234695



1x  
6359865



1x  
6279875



1x  
6195325



1x  
6280097



2x  
393726



2x  
393826



1x  
6329698



1x  
6000650



1x  
6093525



1x  
4188953



1x  
6306748



2x  
6256058



1x  
6244761



1x  
6273627



1x  
6274740



1x  
6325978



1x  
6325955



3x  
6213778



6x  
6213776



1x  
6429249



3x  
6210399



7x  
6217659



2x  
6342088



2x  
6293302



2x  
6213787

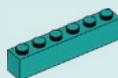

5x  
6396079



2x  
6291782



1x  
6259794



1x  
4624381



1x  
6258352



1x  
6258353



1x  
6264062



1x  
6286831



1x  
6185108



2x  
6092592



1x  
6102906



1x  
6430052



1x  
6424457



1x  
6060795



1x  
6409759



4x  
6194729



1x  
6287856



1x  
6416551



1x  
6196796



2x  
6312460



3x  
4651231



2x  
6223506



1x  
4624086



1x  
6226646



2x  
6424480



1x  
4113917



2x  
6292154



1x  
6291414



1x  
4114084



1x  
6429228



1x  
6416639

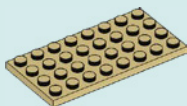

1x  
4509897



2x  
6192922



1x  
6430144



1x  
6135191



4x  
6258566

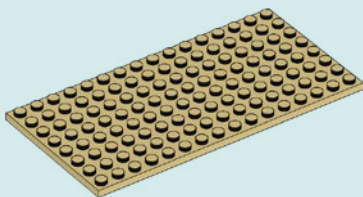

1x  
4609726



1x  
6093494



2x  
6287638



1x  
6099341



4x  
6425367



1x  
6295464



2x  
4159553

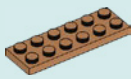

1x  
6313600



1x  
6374151



 [LEGO.com/service](https://www.lego.com/service)

YOU COULD

# WIN



Scan this QR code or go to  
**LEGO.COM/PRODUCTFEEDBACK**  
and give us your short feedback  
about this LEGO® set for a chance  
to win a cool LEGO prize.

Terms and Conditions apply\*

**DE: Du könntest GEWINNEN.** Es gelten die Teilnahmebedingungen\* **FR: Tu pourrais GAGNER.** Des conditions s'appliquent\* **IT: Potresti VINCERE tu.** Termini e condizioni sono applicabili\* **ES: Puedes GANAR.** Aplican términos y condiciones\* **PT: Poderá GANHAR.** Aplicam-se termos e condições\* **JA: プレゼント付き! 利用規約が適用されます\*** **ZH: 轻松获奖. 条款和条件适用\*** **KO: 상품의 주인이 되어보세요. 소정의 약관이 적용됩니다\*** **RU: Вы можете ВЫИГРАТЬ.** Действуют положения и условия\* **PL: Szansa na WYGRANĄ.** Obowiązują warunki korzystania\* **CS: Máte šanci VYHRÁT.** Platí všeobecné smluvní podmínky\* **SK: Máte šancu VYHRÁT.** Platia všeobecné zmluvné podmienky\* **HU: TE IS NYERHETSZ.** Felhasználási feltételek érvényesek\* **RO: Ai putea CÂȘTIGA.** Se aplică termeni și condiții\* **BG: Можете да СПЕЧЕЛИТЕ.** Има определени правила и условия\* **LV: Tu vari LAIMĒT.** Ir spēkā noteikumi un nosacījumi.\* **ET: Sul on võimalus VÕITA.** Kehtivad tingimused\* **LT: Jūs galite LAIMĖTI.** Taikomos sąlygos\*

\*[LEGO.com/productfeedback-terms](https://www.lego.com/productfeedback-terms)

LEGO, the LEGO logo and the FRIENDS logo are trademarks of the/  
sont des marques de commerce du/son marcas registradas de LEGO Group.

©2023 The LEGO Group.

All rights reserved/Tous droits réservés/Todos los derechos reservados.

6447579