



# Mixels™

## CHILBO



41540



7 [LEGO.com](http://LEGO.com)

6126516

1

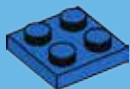

2

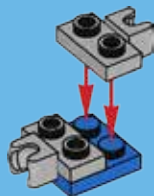

3



4

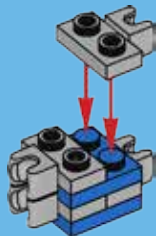

5



6

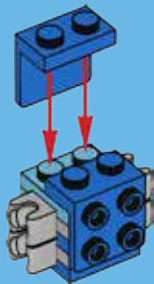

7

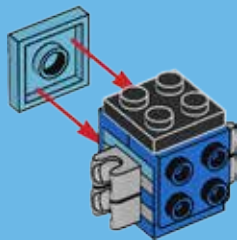

8

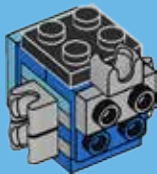

9

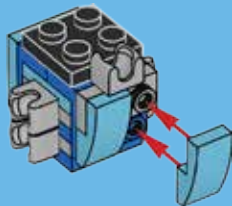



10



11



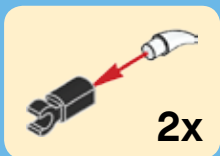

12

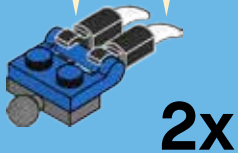

13

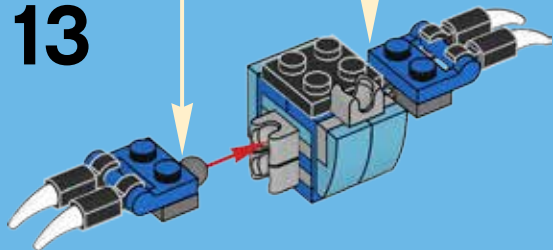



14

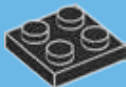

15





16



17



18

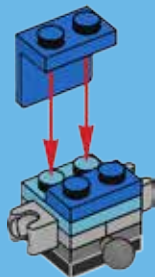

19

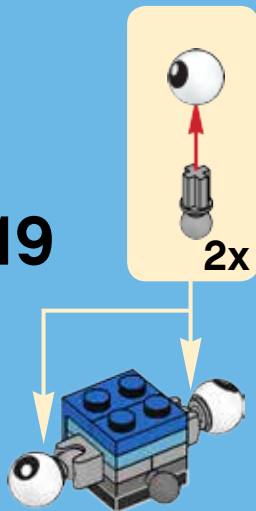

20

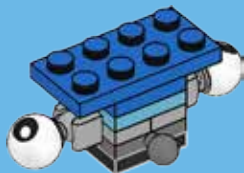

21

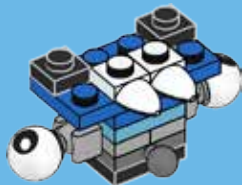

22

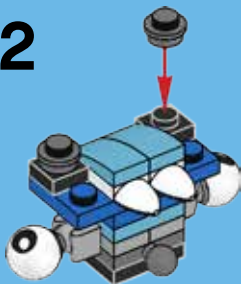

23





24

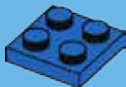

25



26



27

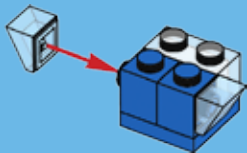

28



29

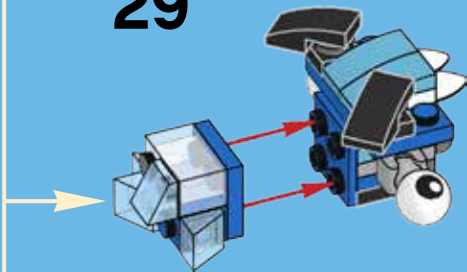

**30**

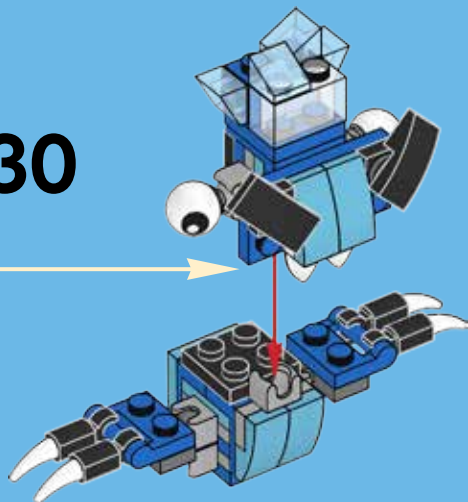



**31**

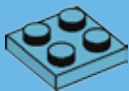

**32**

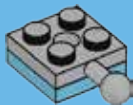

**33**

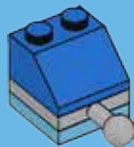



34

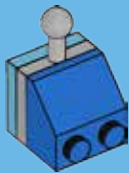

2x

35

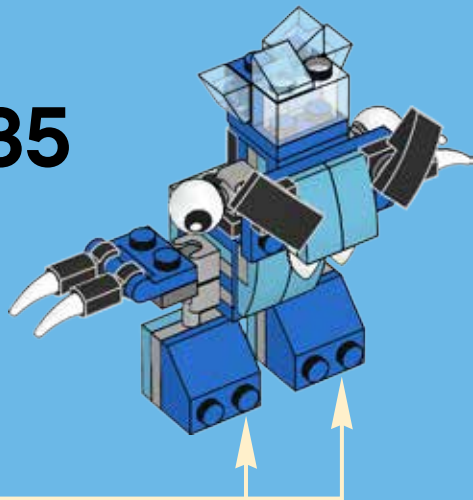

36

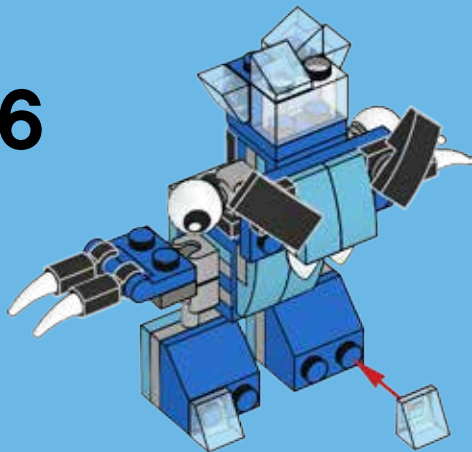

37

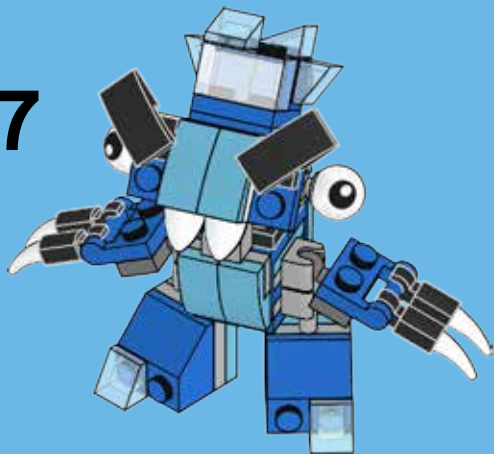



4x  
6071246



6x  
4611464



7x  
6043656



4x  
4568387



2x  
302426



3x  
6117968



5x  
4625032



3x  
6039479



2x  
6063611



2x  
4224792



2x  
302226



2x  
4514398



1x  
306540



2x  
4210633



2x  
4211375



2x  
6056225



4x  
6015891



2x  
302323



**Customer Service**

**Kundenservice**

**Service Consommateurs**

**Servicio Al Consumidor**

**LEGO.com/service or dial**



**00800 5346 5555 :**



**1-800-422-5346 :**



2x  
6047276



2x  
4583862



3x  
302223



2x  
303923



1x  
302023



**KROG  
41539**



**FROSTICONS  
MAX!**



**CHILBO  
41540**



**SNOOF  
41541**



[LEGO.com/mixels](http://LEGO.com/mixels)





# Mixels™

SERIES  
**5**



**41536  
GOX**



**41537  
JINKY**



**41538  
KAMZO**



**41539  
KROG**



**41540  
CHILBO**



**41541  
SNOOF**



**41542  
SPUGG**



**41543  
TURG**



**41544  
TUNGSTER**



[LEGO.com/mixels](http://LEGO.com/mixels)





**YOU CAN  
BUY THE  
GAME!**

**S N 8 W I T A 1 1**

**IN GAME CODE!**

# MIXELS RUSH



Apple, the Apple logo, iPad, iPhone and iPod touch are trademarks of Apple Inc. Google Play is a trademark of Google Inc.