



Mixels

41506
TESLO



MAX!



41507
ZAPTOR



41508
VOLECTRO



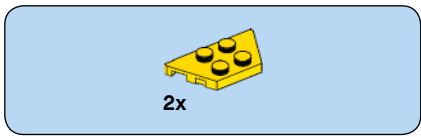

1

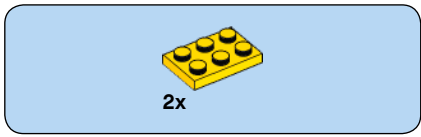
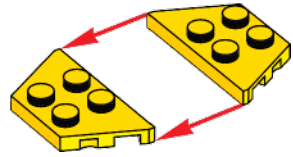

2

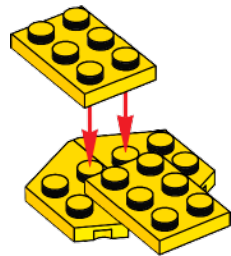



2x

3

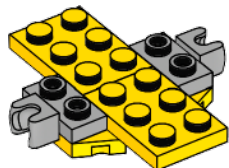

2x

4

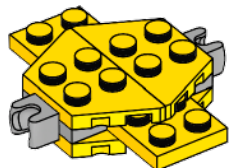

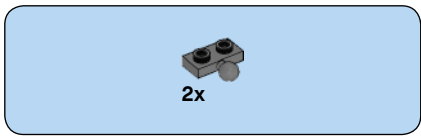

5

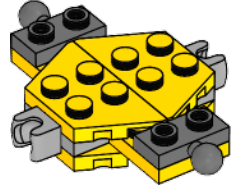

6

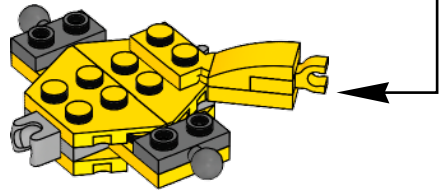
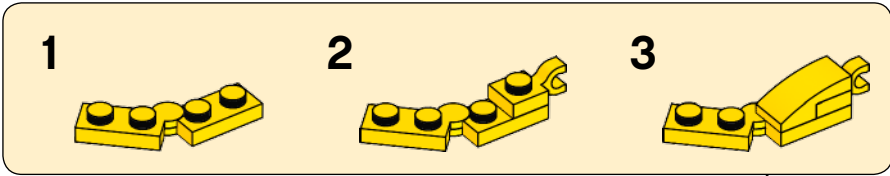

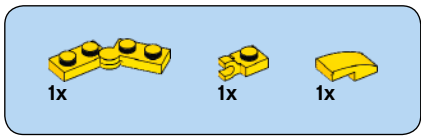

7

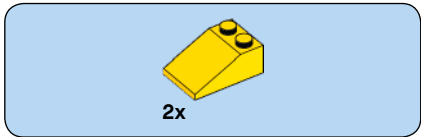
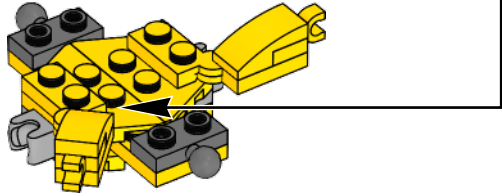
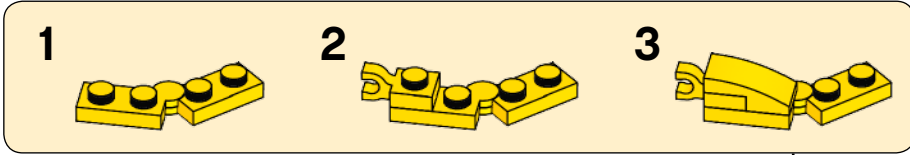

8

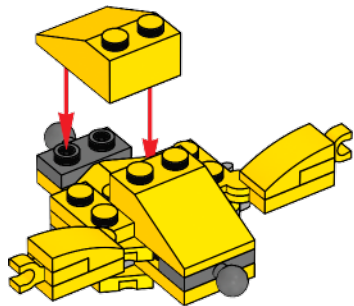

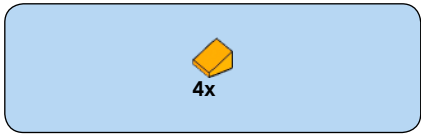

9

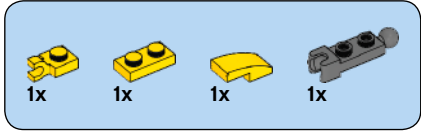
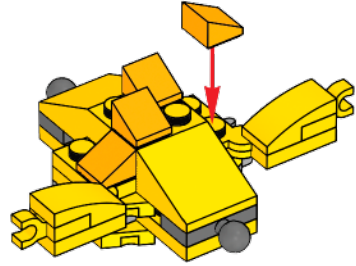

10

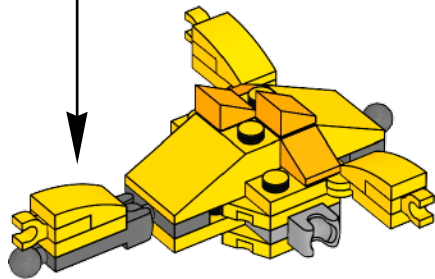

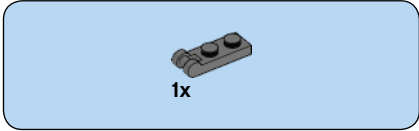
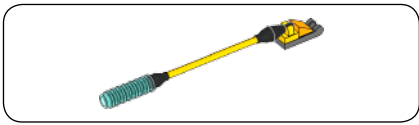

1

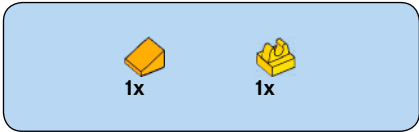
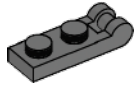

2

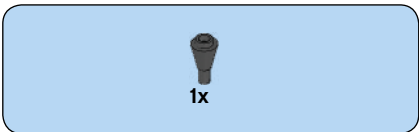
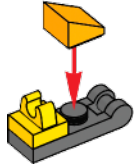

3



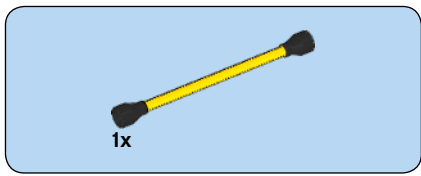

4



5

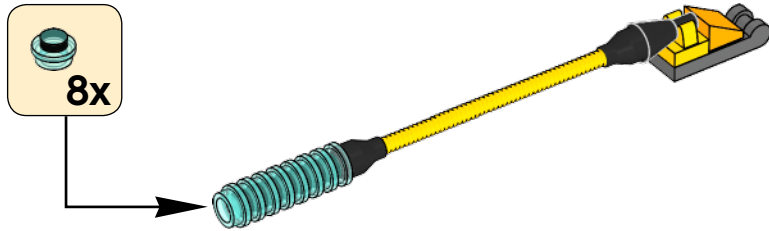

11

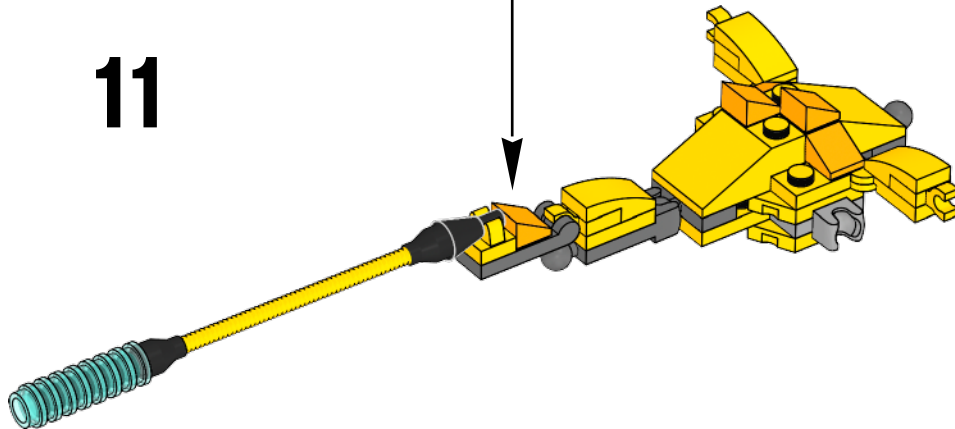

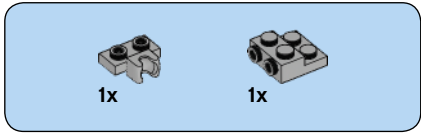
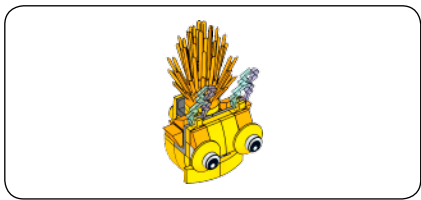

1

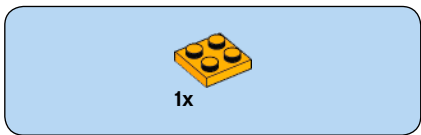
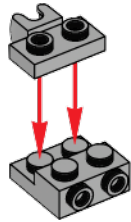

2

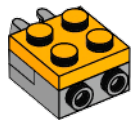

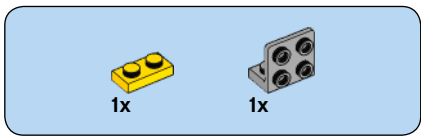

3

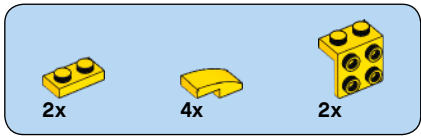
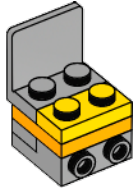

4

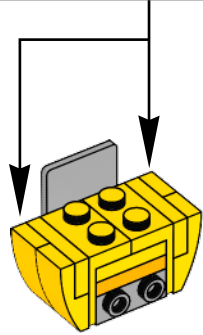
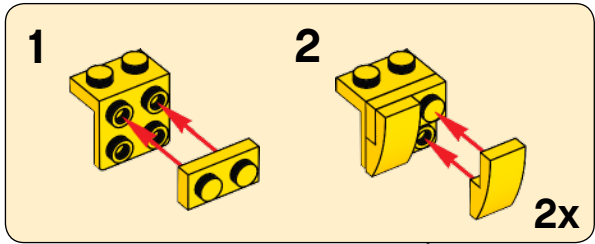

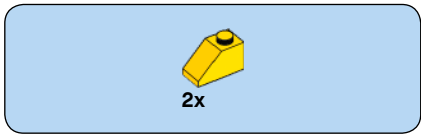

5

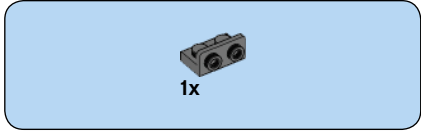
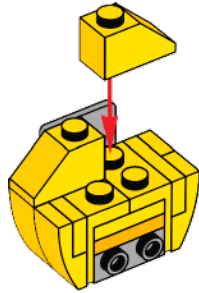

6

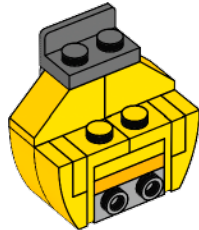

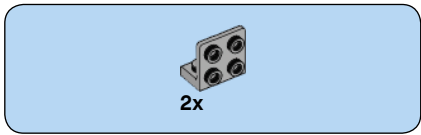

7

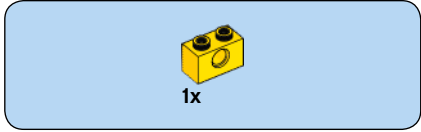
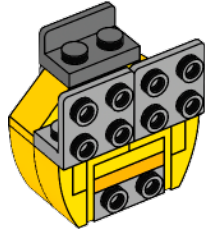

8

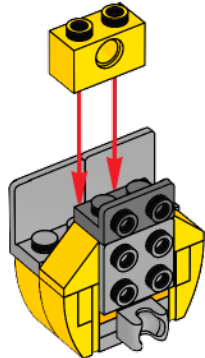
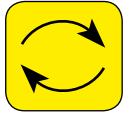

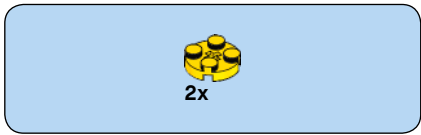

9

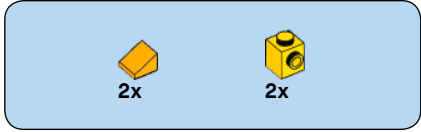
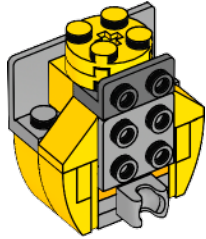
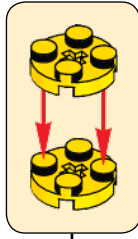

10

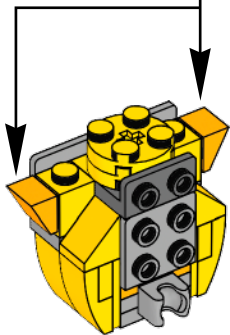
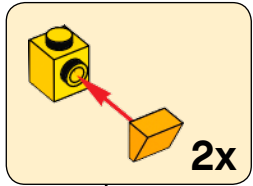

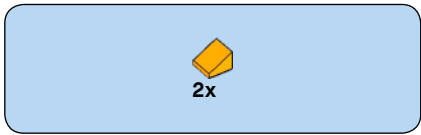

11

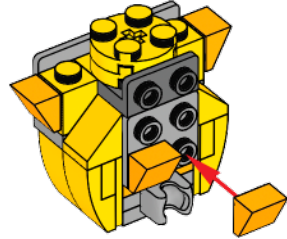

12

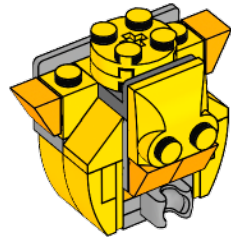



2x

13

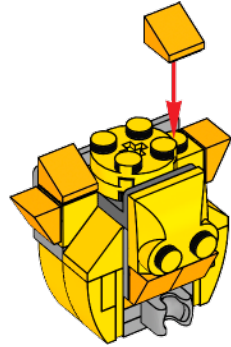

1x

14

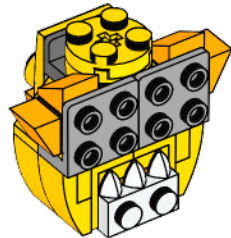
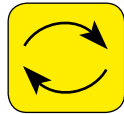

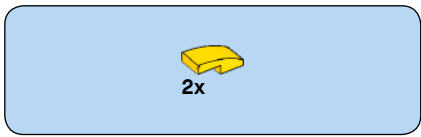

15

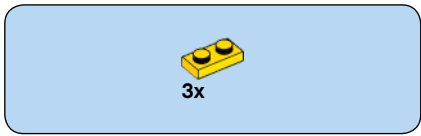
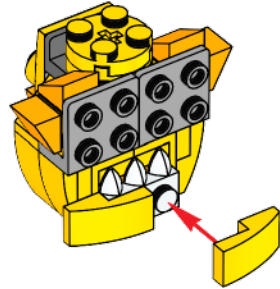

16

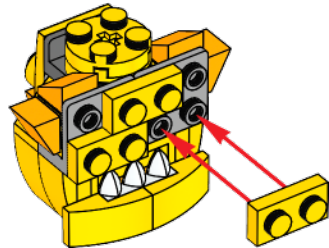



2x

17

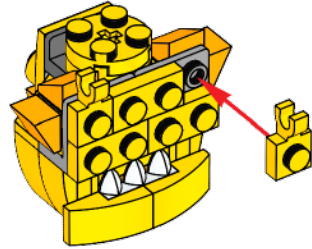

2x



1x

18

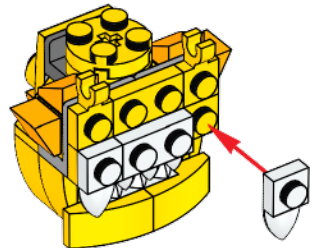

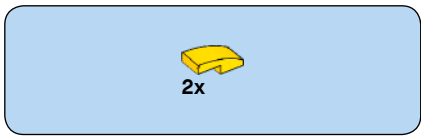

19

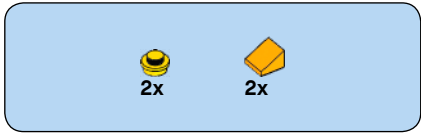
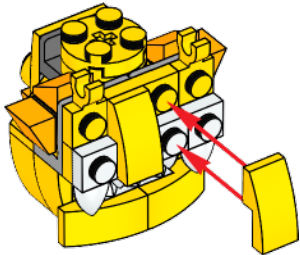

20

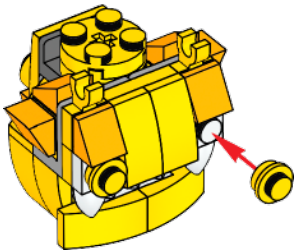

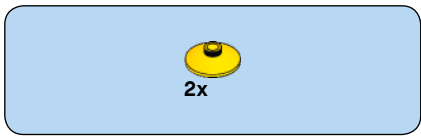

21

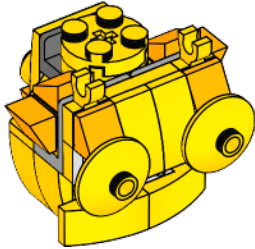

22

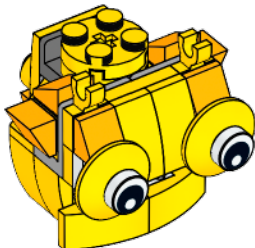



1x

23

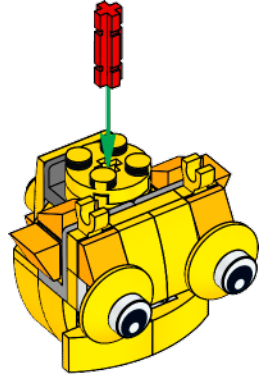

1x

24

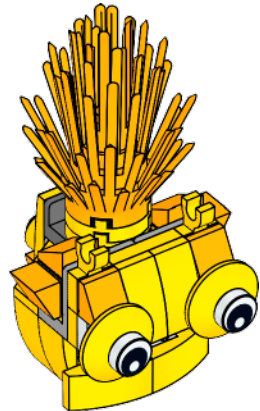

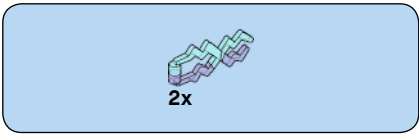

25

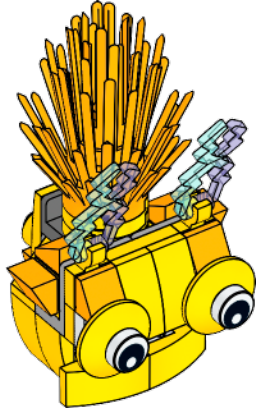

26

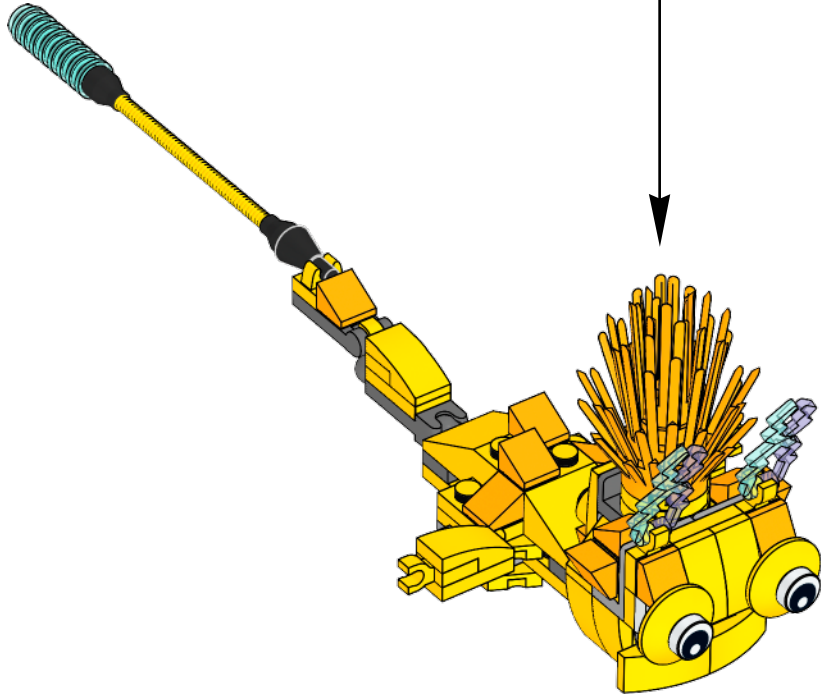

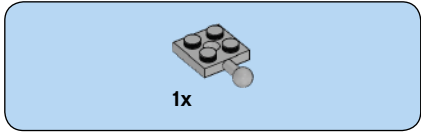
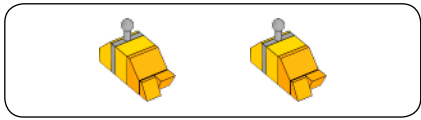

1

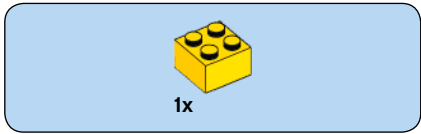

2

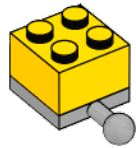

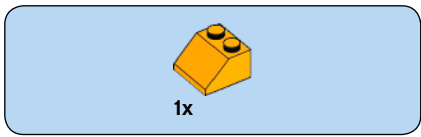

3

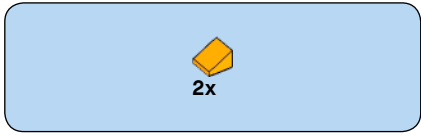
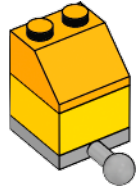

4

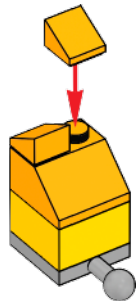

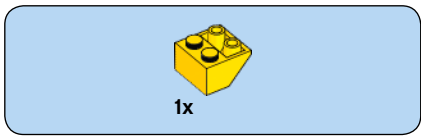

5

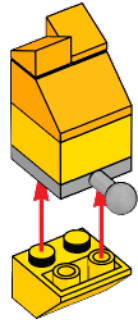

6

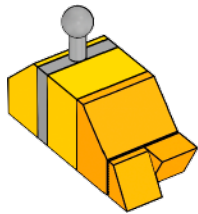
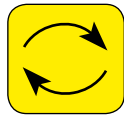

2x

27

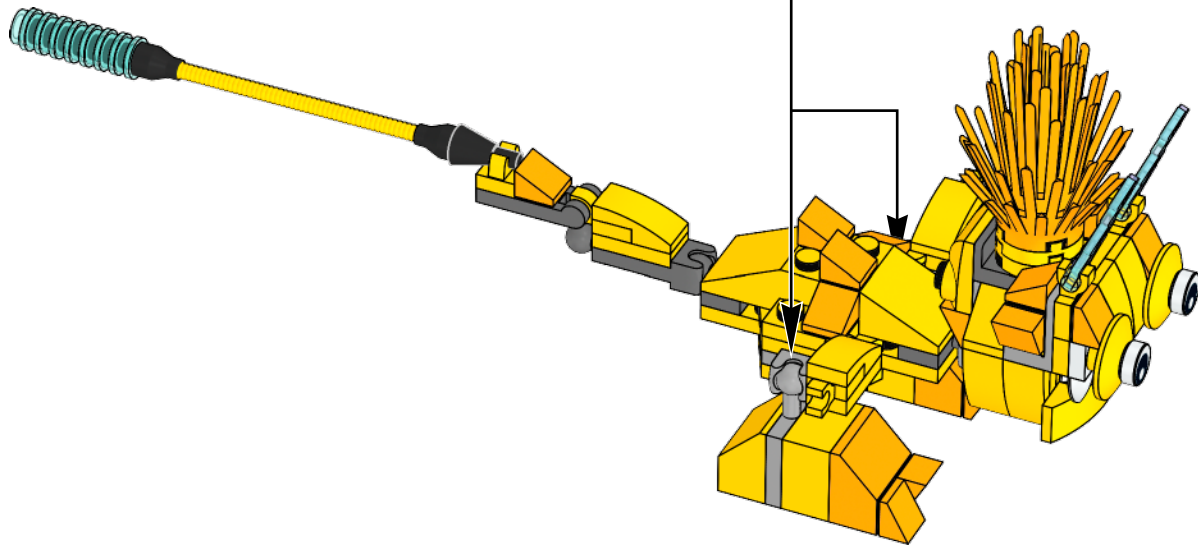

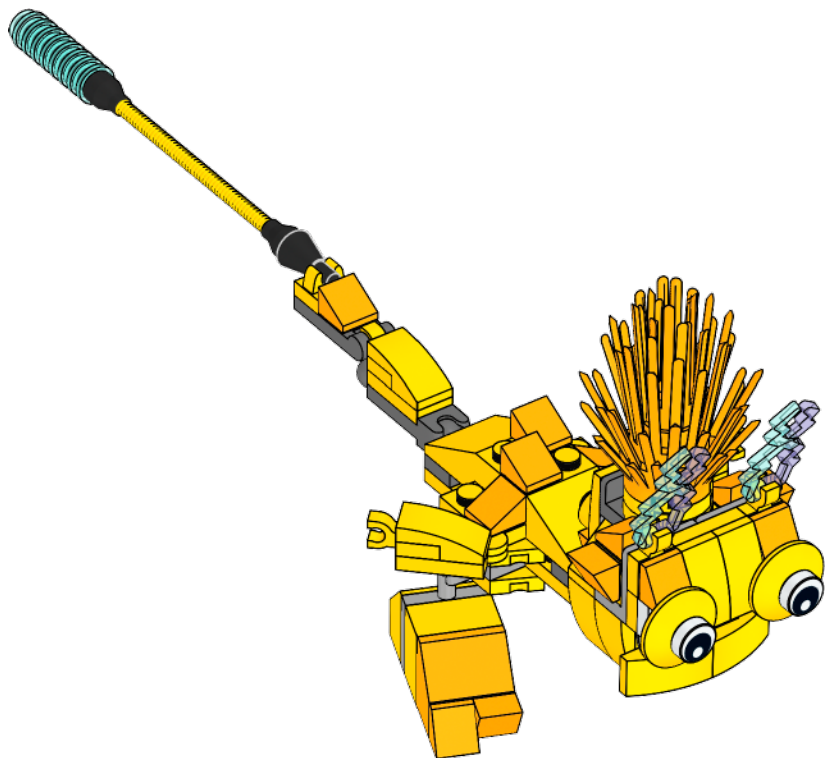

LEGO, the LEGO logo and MIXELS are trademarks and/or copyrights of the/sont des marques de commerce et/ou copyrights du/son marcas registradas, algunas de ellas protegidas por derechos de autor, de LEGO Group. ©2014 The LEGO Group. All rights reserved/Tous droits réservés/Todos los derechos reservados.

TM & © 2014 Cartoon Network.



Customer Service
 Kundenservice
 Service Consommateurs
 Servicio Al Consumidor
 LEGO.com/service or dial

: 00800 5346 5555
 : 1-800-422-5346