



Friends™



41306



LEGO.com/friends



WARNING: CHOKING HAZARD.
Small parts. Not for children under 3 years.





AVERTISSEMENT : RISQUE D'ÉTOUFFEMENT.

Contient des petites pièces. Ne convient pas aux enfants de moins de 3 ans.



ADVERTENCIA: PELIGRO DE ASFIXIA.

No recomendado para niños menores de 3 años. Contiene piezas pequeñas.

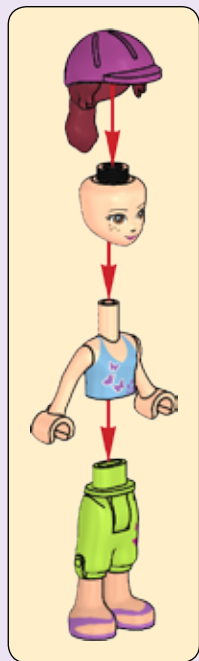

1

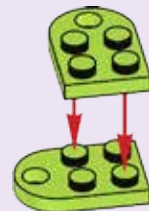

2



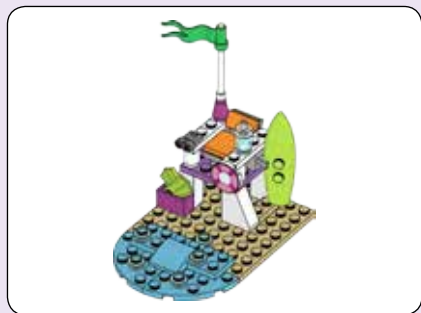

1

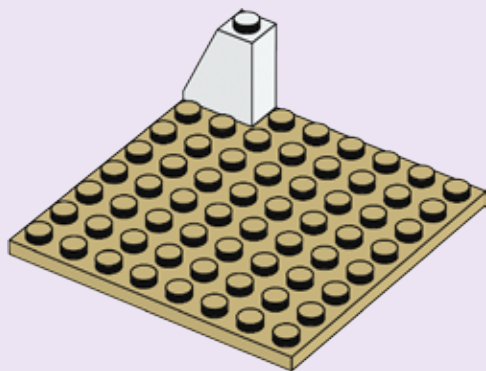

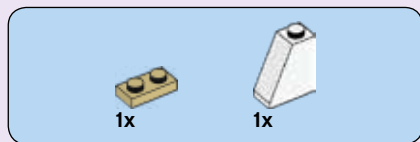

2

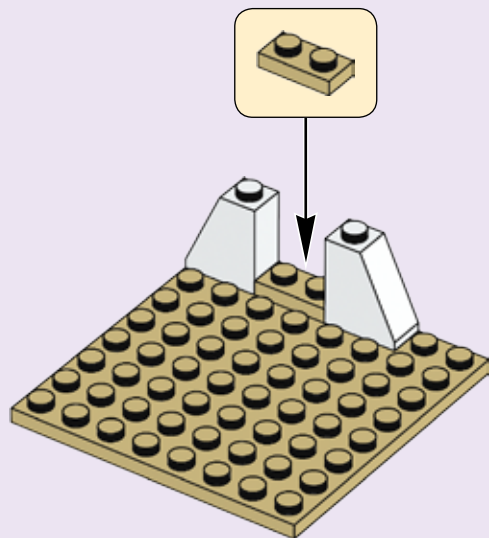

3

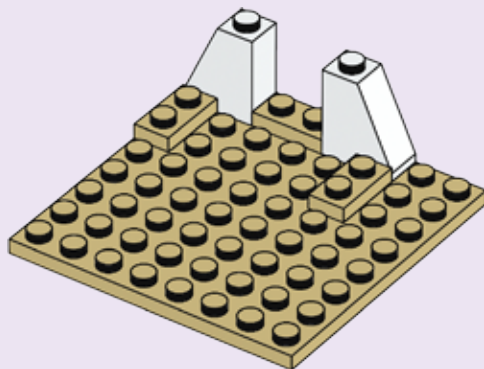



2x

4

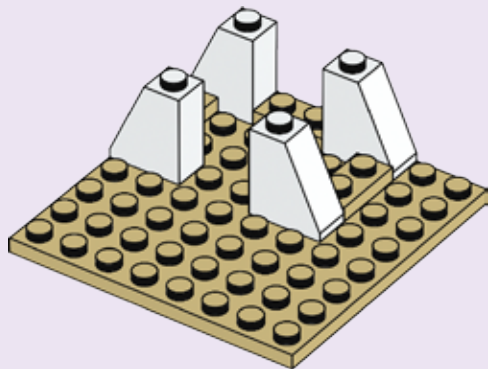

6



1x

5

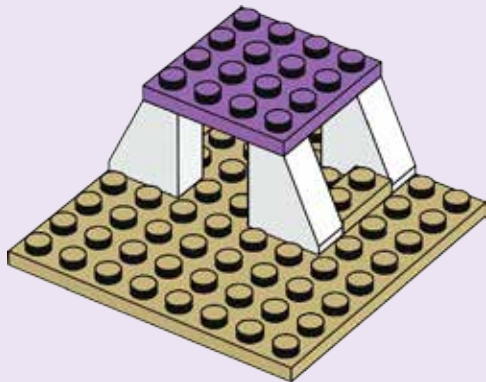



3x

6

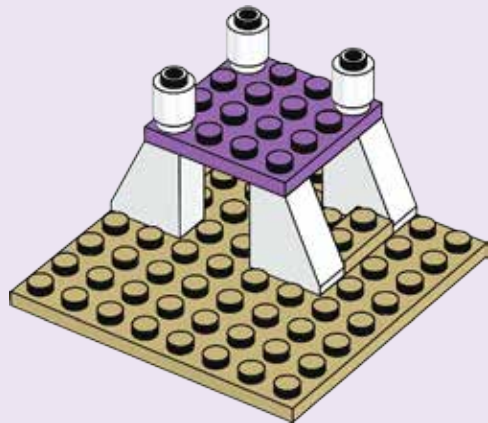

1x



1x

7

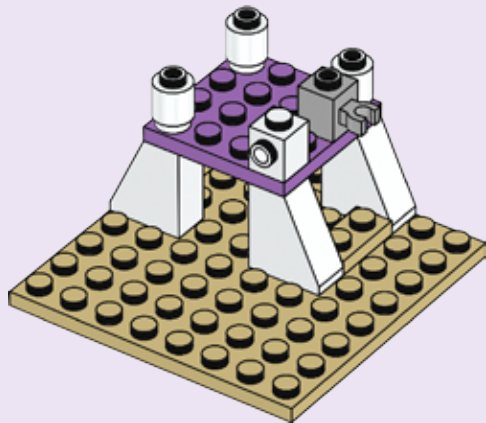



2x

8

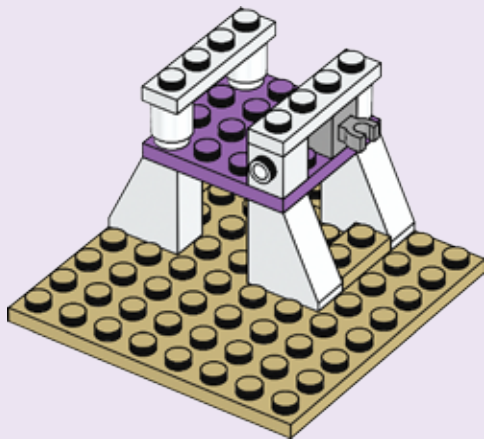

8

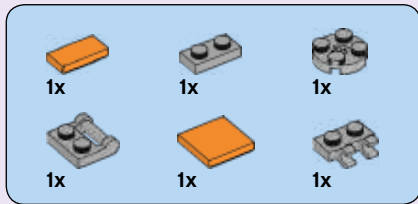

9

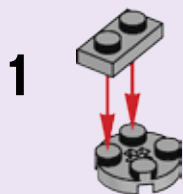

2



3

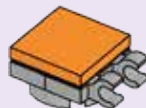

4

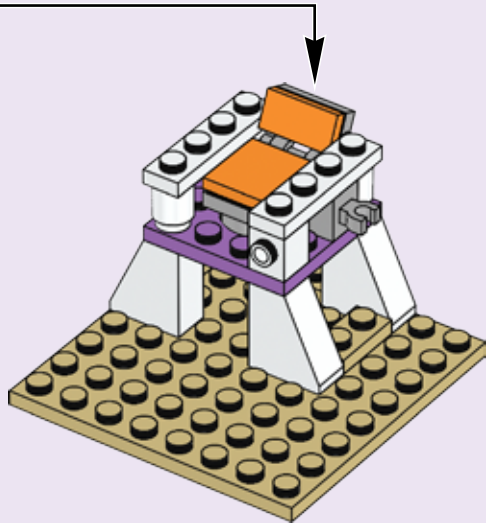
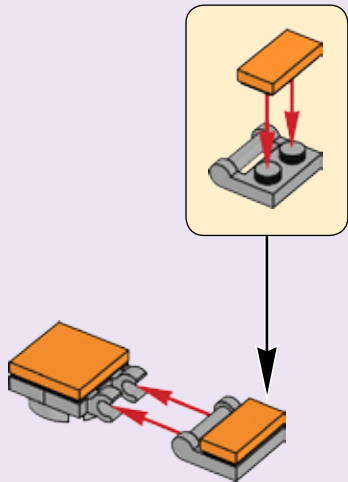



1x



1x



1x

10

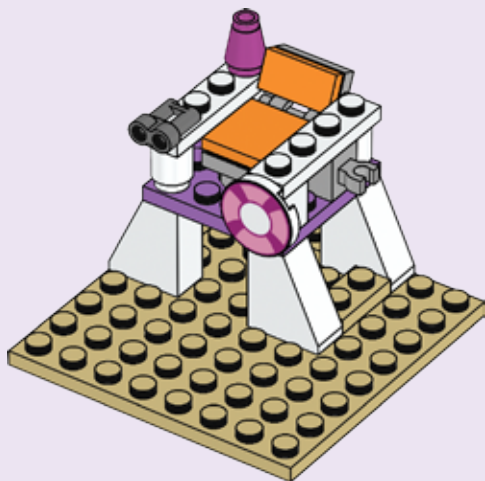

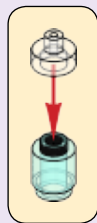
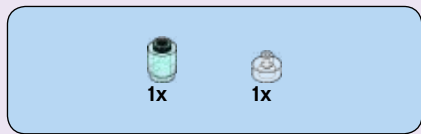

11

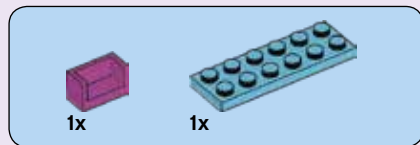
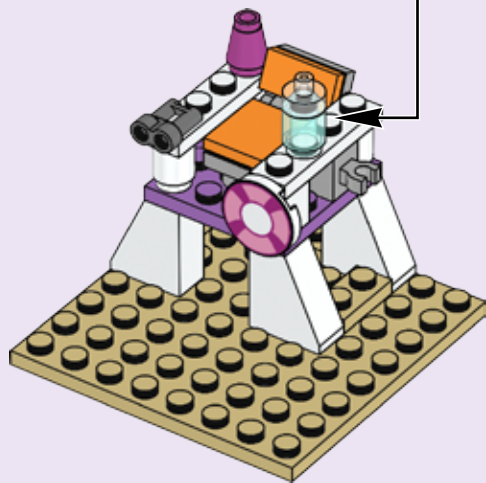

12

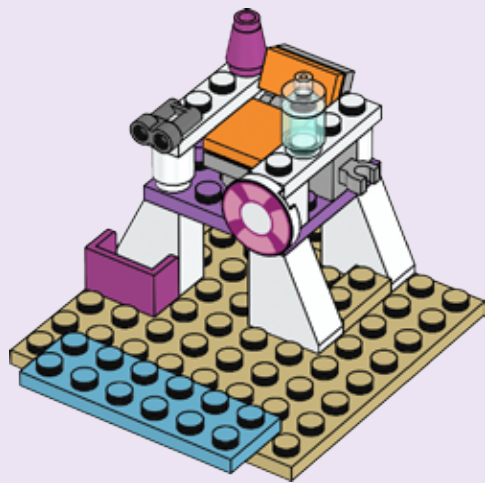



2x

13

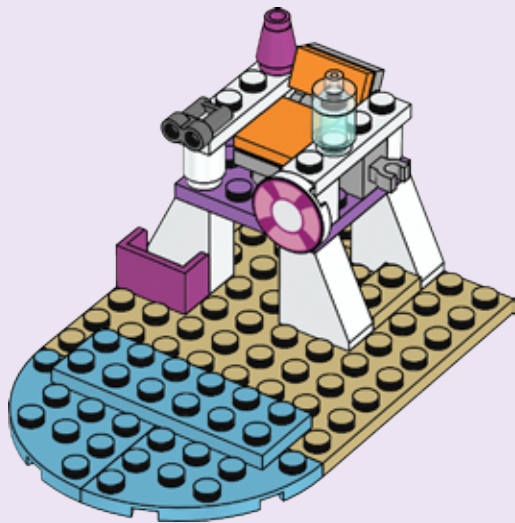

5x



1x

14

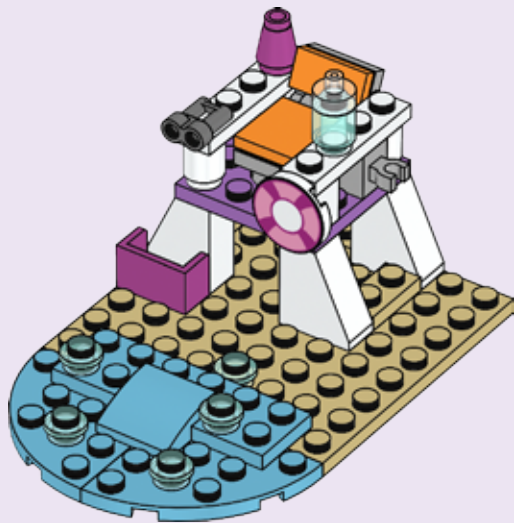

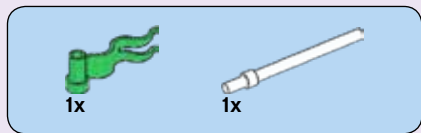

15

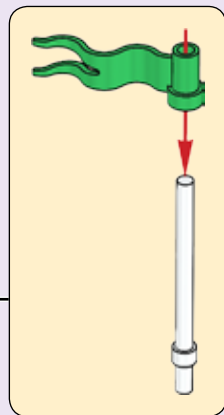
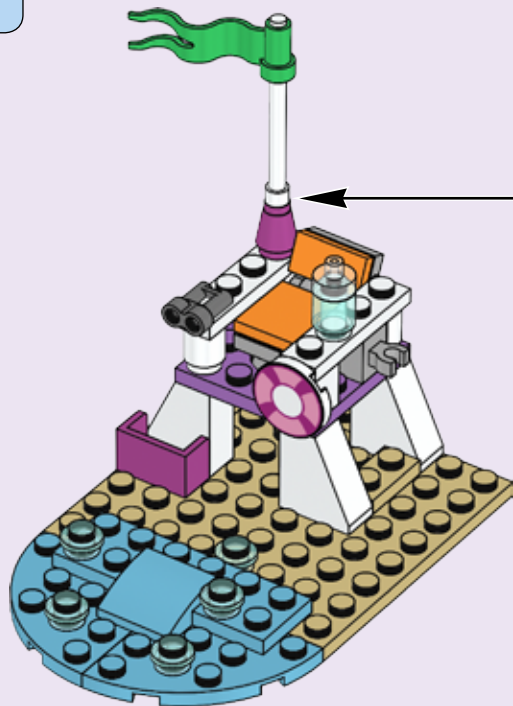

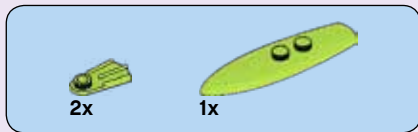

16

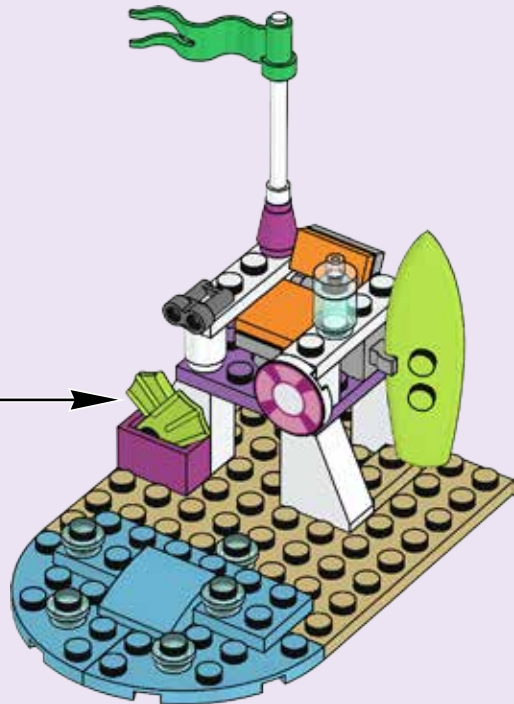



1x

1

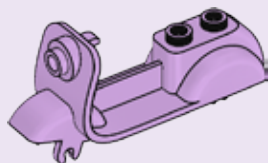



2x



2x

2

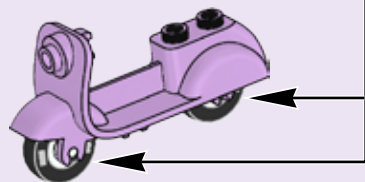
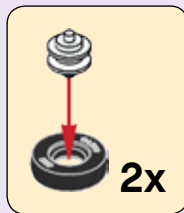

1x



1x

3

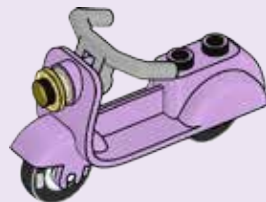

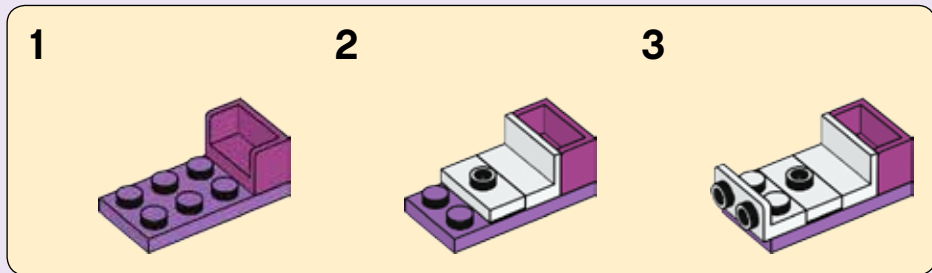
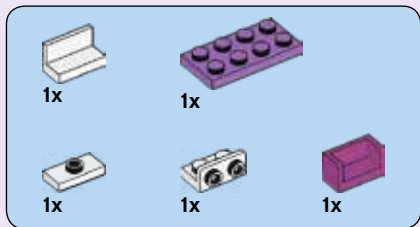

4

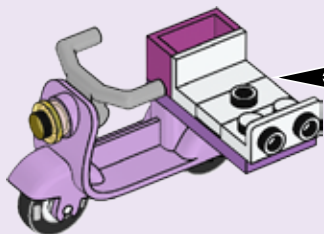



1x

5



1x

6





1x



2x

7

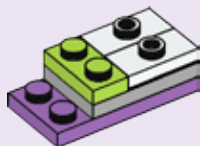

20



2x

8

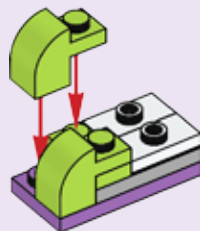



1x

9

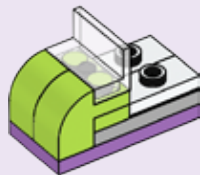

1x



1x



1x

10

1



2



3

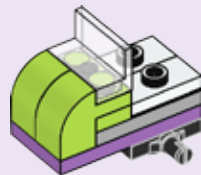



1x



1x

11

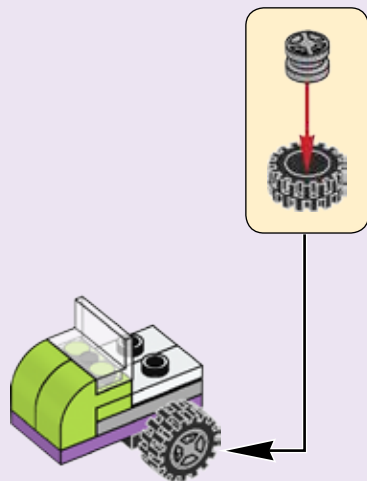

12

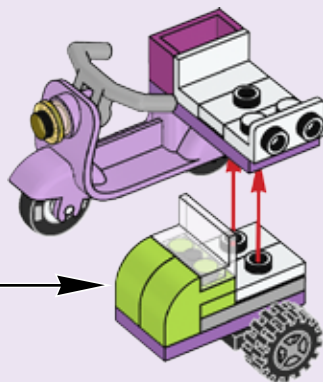



13

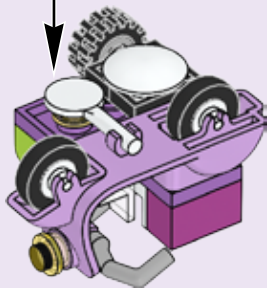
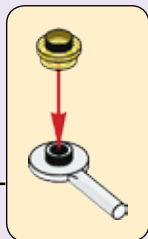
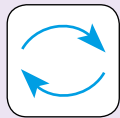

14

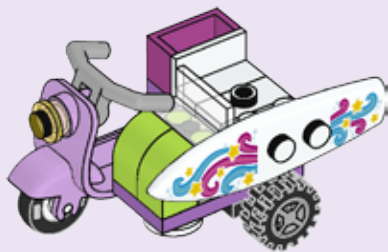
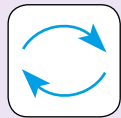

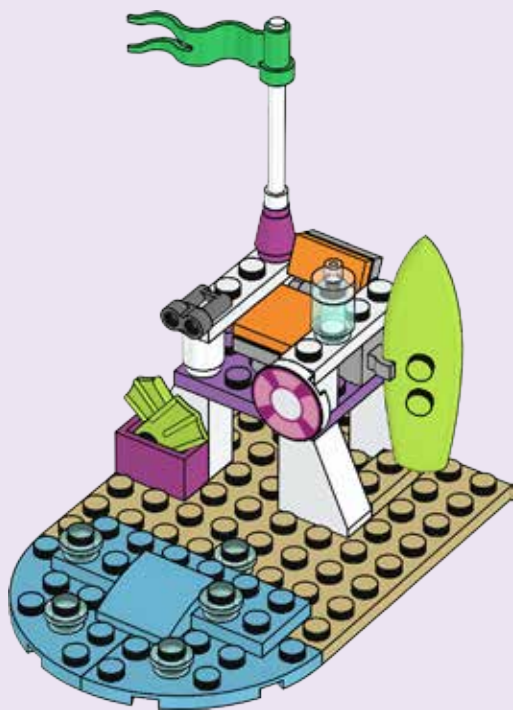



41305
Emma



41306
Mia



41307
Olivia



41308
Stephanie



41309
Andrea



3x
306201



2x
429697



1x
4558952



1x
6052202



1x
4278271



1x
486501



3x
6051511



4x
4515370



1x
390001



1x
6070698



2x
371001



1x
6081986



1x
6102816



1x
6133256



3x
4113917



1x
4624223



1x
4578677



1x
6122656



2x
4516843



1x
302326



1x
449528



1x
6112751



1x
6054554



1x
4183544



5x
4163917



2x
3005744



1x
4542142



1x
4188771



1x
6103707



2x
6022112



1x
4164037



2x
4212446



2x
6175325



1x
6102906



1x
6003007



2x
6131870



1x
6096991



1x
6115792



1x
4211506



1x
4533772



1x
4211475



1x
4211398



1x
4556157



1x
4244627



1x
4644102



1x
4211396



1x
4211051



1x
6017024



1x
6102009



1x
6152676



1x
6119126



2x
6056271



1x
6146926



2x
4619516



1x
6133296



1x
6172817



Customer Service

Kundenservice

Service Consommateurs

Servicio Al Consumidor

LEGO.com/service or dial



00800 5346 5555 :



1-800-422-5346 :





WIN

GO TO [WWW.LEGO.COM/PRODUCTFEEDBACK](http://www.LEGO.COM/PRODUCTFEEDBACK) AND
GIVE US YOUR SHORT **FEEDBACK** ABOUT THIS
LEGO® SET FOR A CHANCE TO WIN
A COOL LEGO PRIZE.

Terms & Conditions apply

LEGO.com/productfeedback

GEWINNE

Erzähle uns auf
www.LEGO.com/productfeedback

etwas über die Erfahrungen, die du mit
diesem LEGO® Set gemacht hast, und
sichere dir die Chance auf einen coolen
LEGO Preis!

Es gelten die Teilnahmebedingungen

GAGNE

Rends-toi sur
www.LEGO.com/productfeedback

et donne-nous quelques commentaires sur
ce produit LEGO® pour avoir une chance
de gagner un prix LEGO !

Voir Conditions Générales

GANAN

Visita
www.LEGO.com/productfeedback

y envíanos tu opinión acerca de este set
LEGO®. ¡Participarás en el sorteo de un
premio LEGO!

Términos y Condiciones aplicables

获取奖品

登录
www.LEGO.com/productfeedback

给出关于此乐高®套装的简短反馈，
就有机会获得炫酷乐高奖品

《条款及条件》适用



Friends™

LEGO.com/friends

41305

I ♡ Emma



41307



Olivia





Mia I

41306

- 4 x 
- 5 x 
- 7 x 
- 3 x 
- 3 x 
- 3 x 



I ♪ Andrea



41309



LEGO.com/friends



ANDROID APP ON
Google play

Download on the
App Store

Ask parents' permission first.
Demande d'abord l'autorisation d'un parent.
Pide antes permiso a tus padres.



LEGO Friends

Apple and the Apple logo are trademarks of Apple Inc., registered in the U.S. and other countries. App Store is a service mark of Apple Inc. Google Play is a trademark of Google Inc.

LEGO, the LEGO logo and the FRIENDS logo are trademarks of the/son des marques de commerce
du/son marcas registradas de LEGO Group. ©2017 The LEGO Group. 6203422



FriendsTM

