

3429



SPORTS



 **WARNING: CHOKING HAZARD.**  
Toy contains small parts and a small ball.  
Not for children under 3 years.

4195747



3427





3428



3429



3433

3560



3561



3562



3563



3564



3565



3566



3567



**⚠️ AVERTISSEMENT : RISQUE D'ÉTOUFFEMENT.**  
Le jouet contient des petites pièces ainsi qu'une petite boule.  
Il ne convient pas aux enfants de moins de 3 ans.

**⚠️ ADVERTENCIA: PELIGRO DE ASFIXIA.**  
Juguete que contiene partes pequeñas y una pelota pequeña.  
No recomendado para niños menores de 3 años.

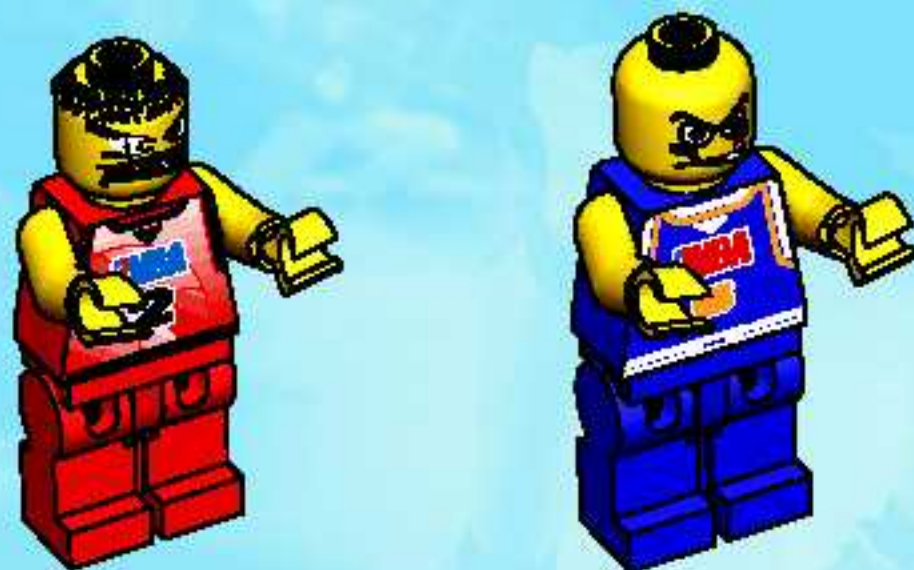
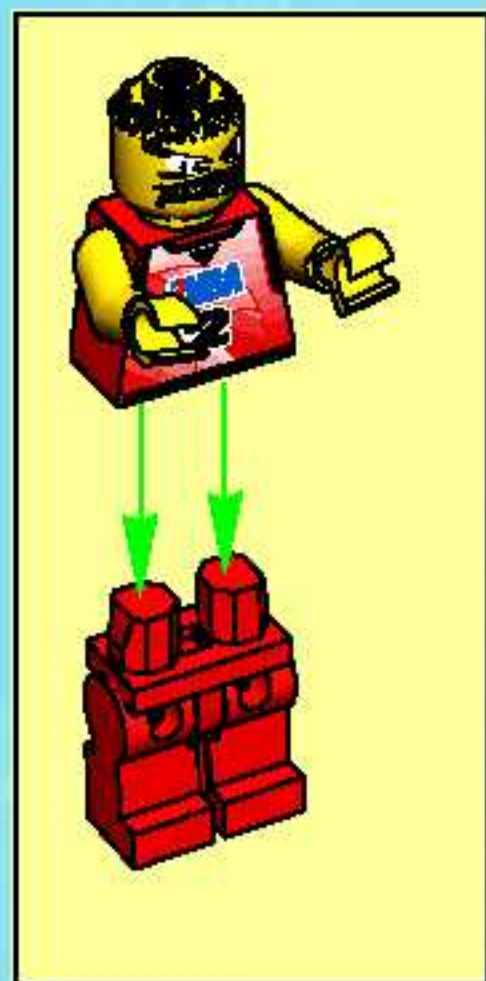

**1**

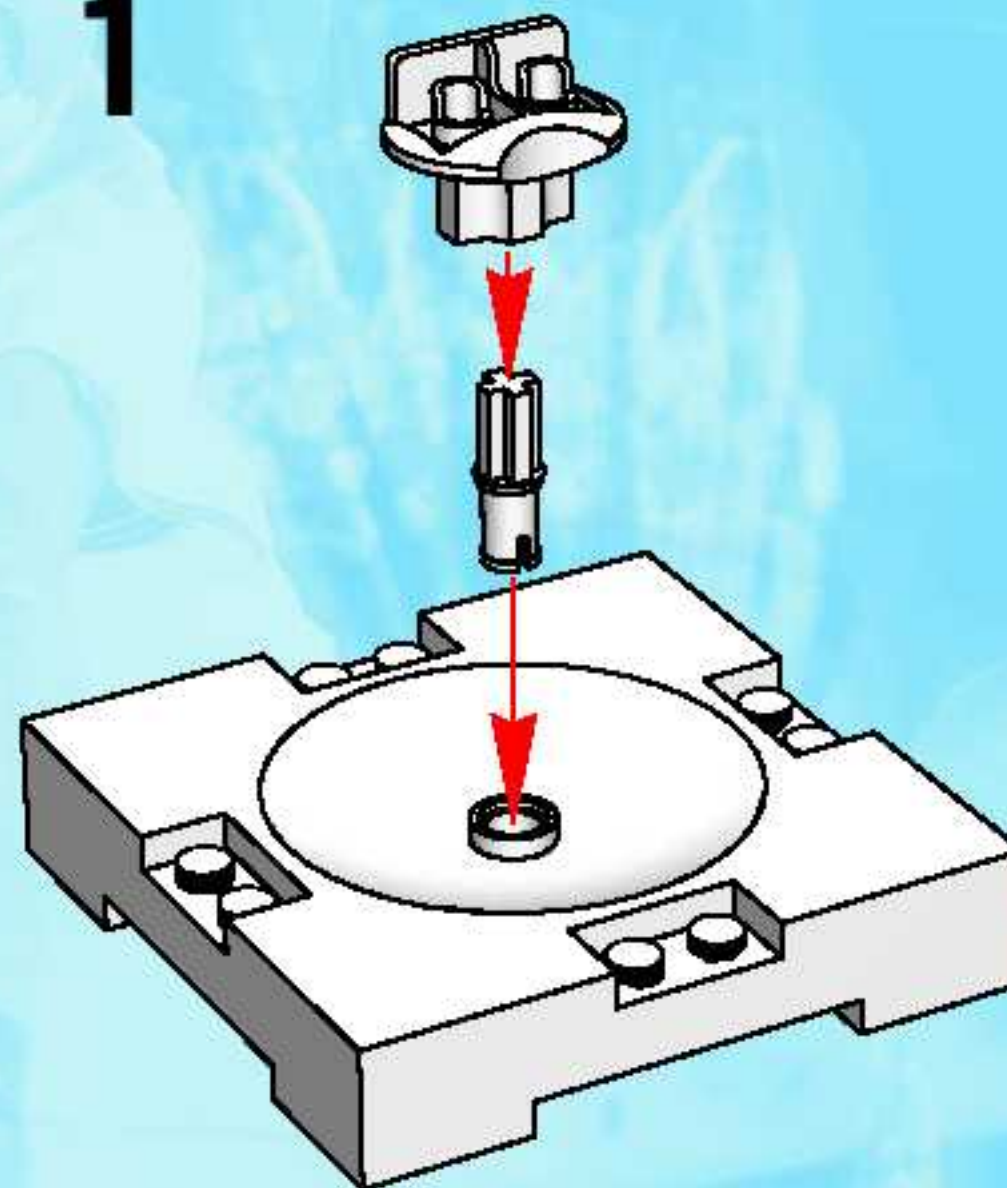

2

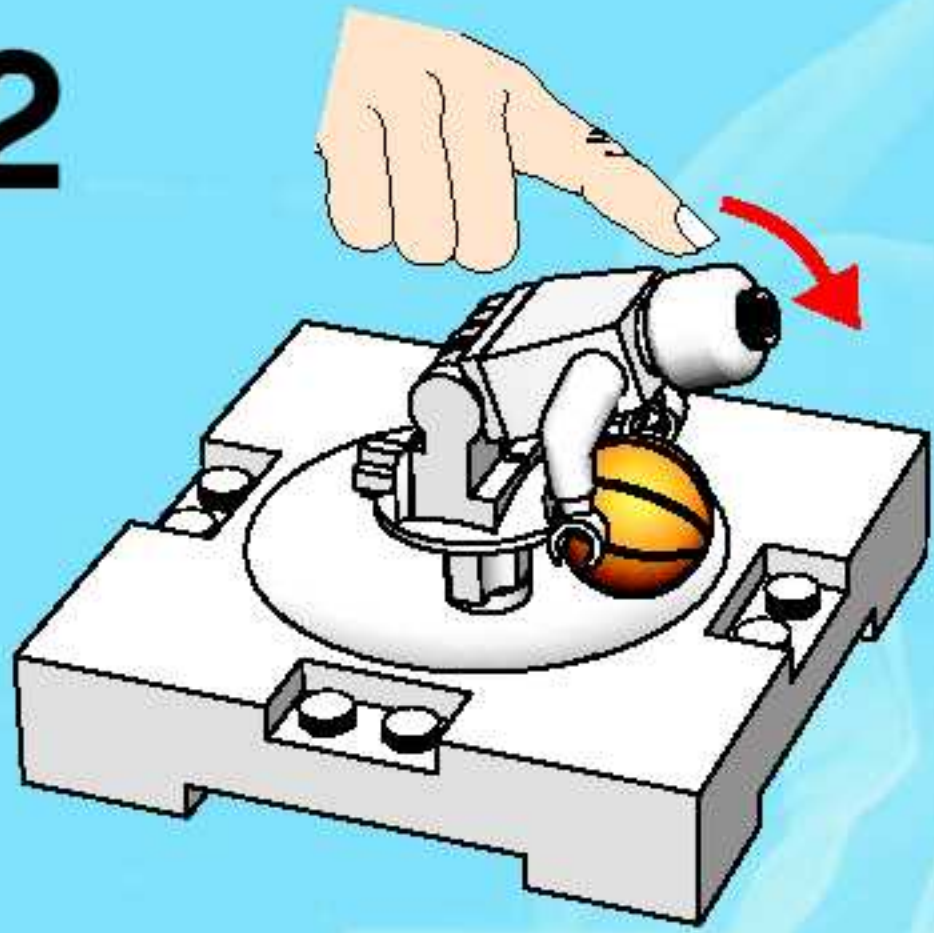

3

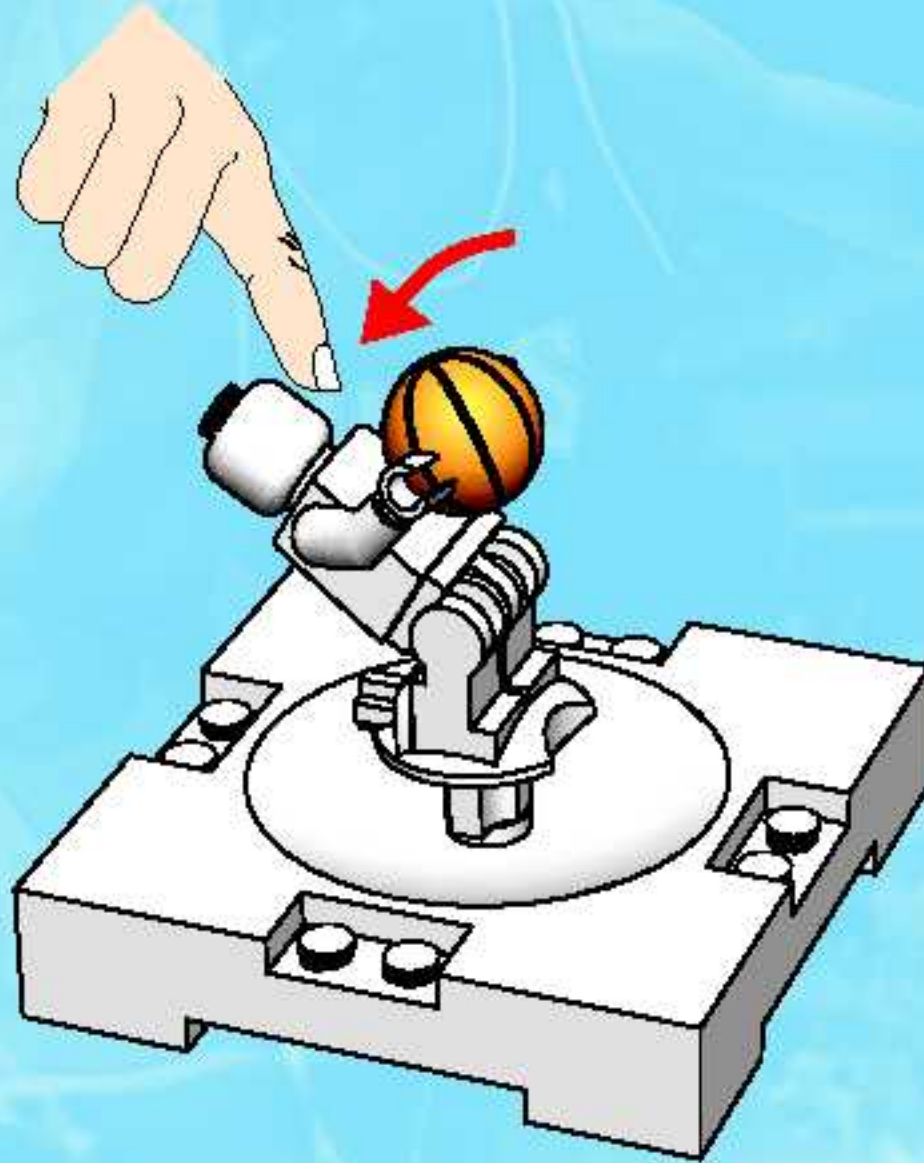

4

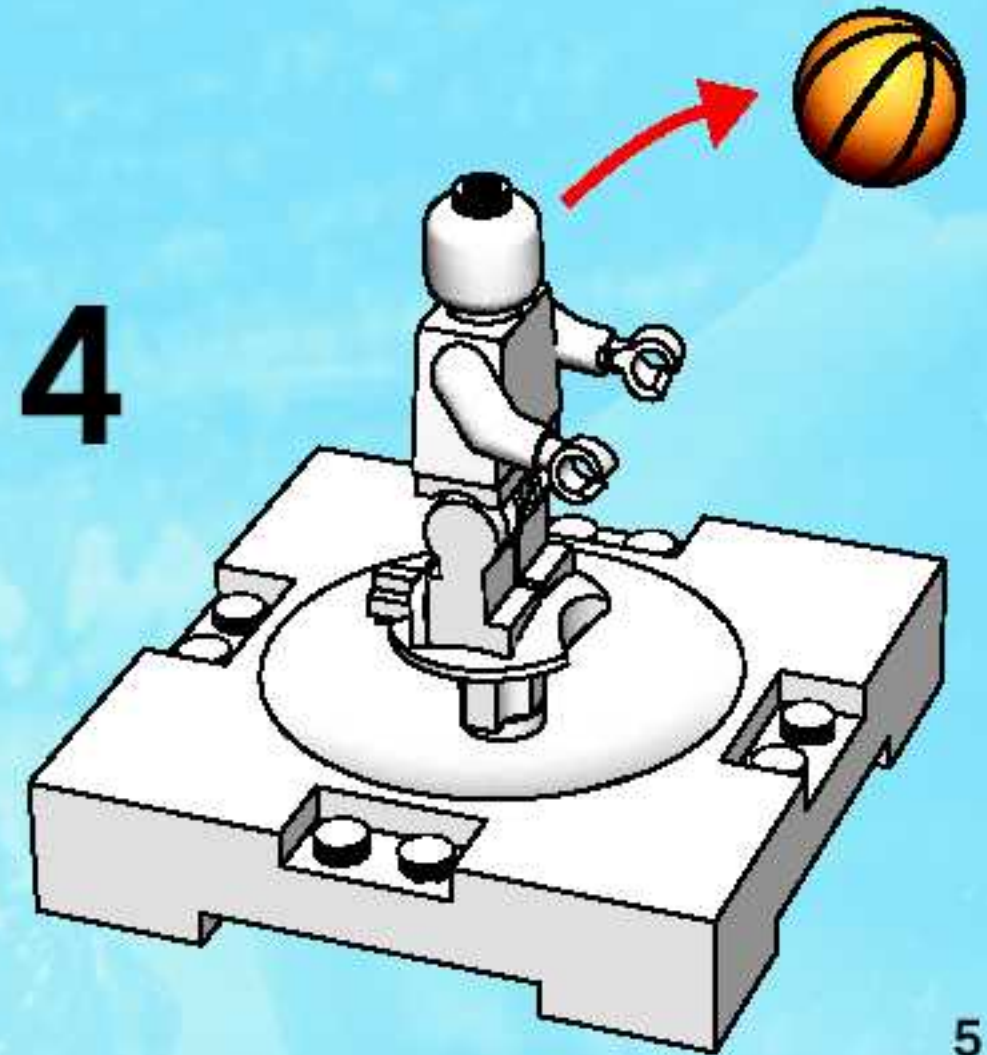



1

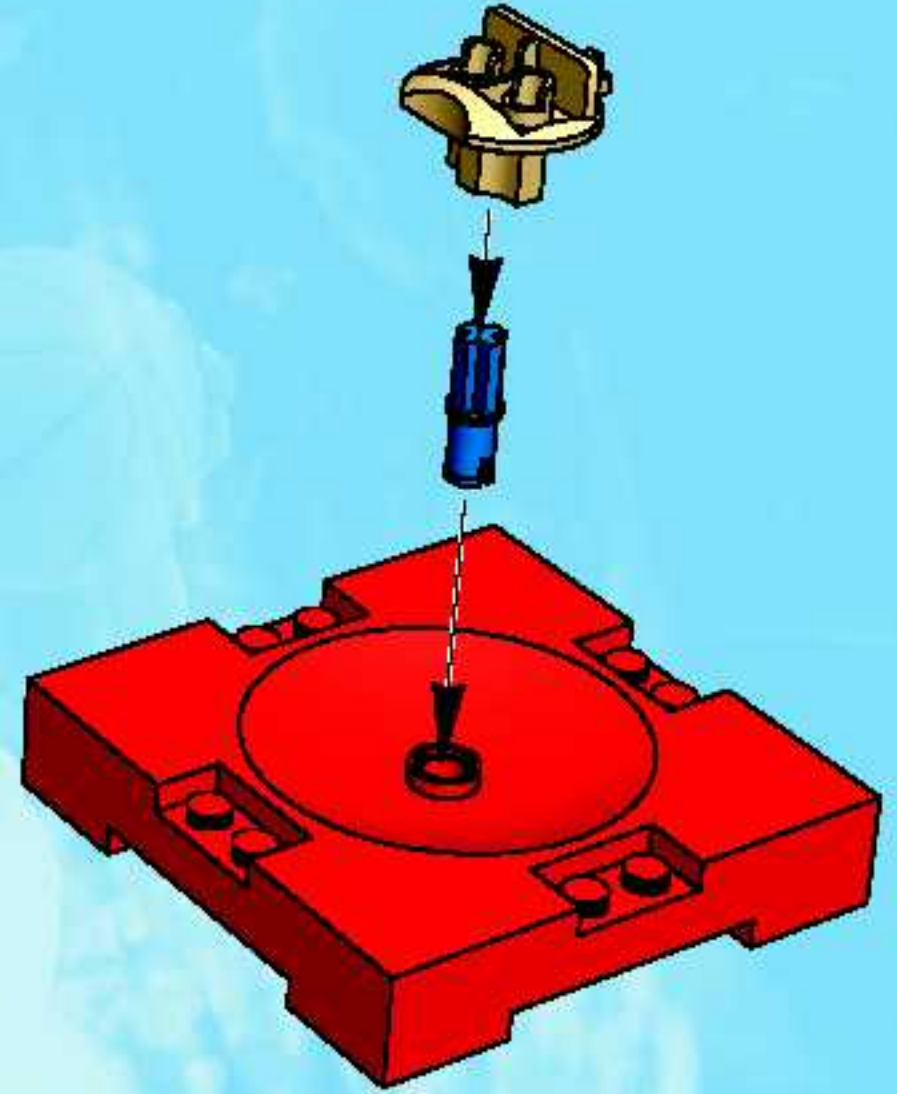

2

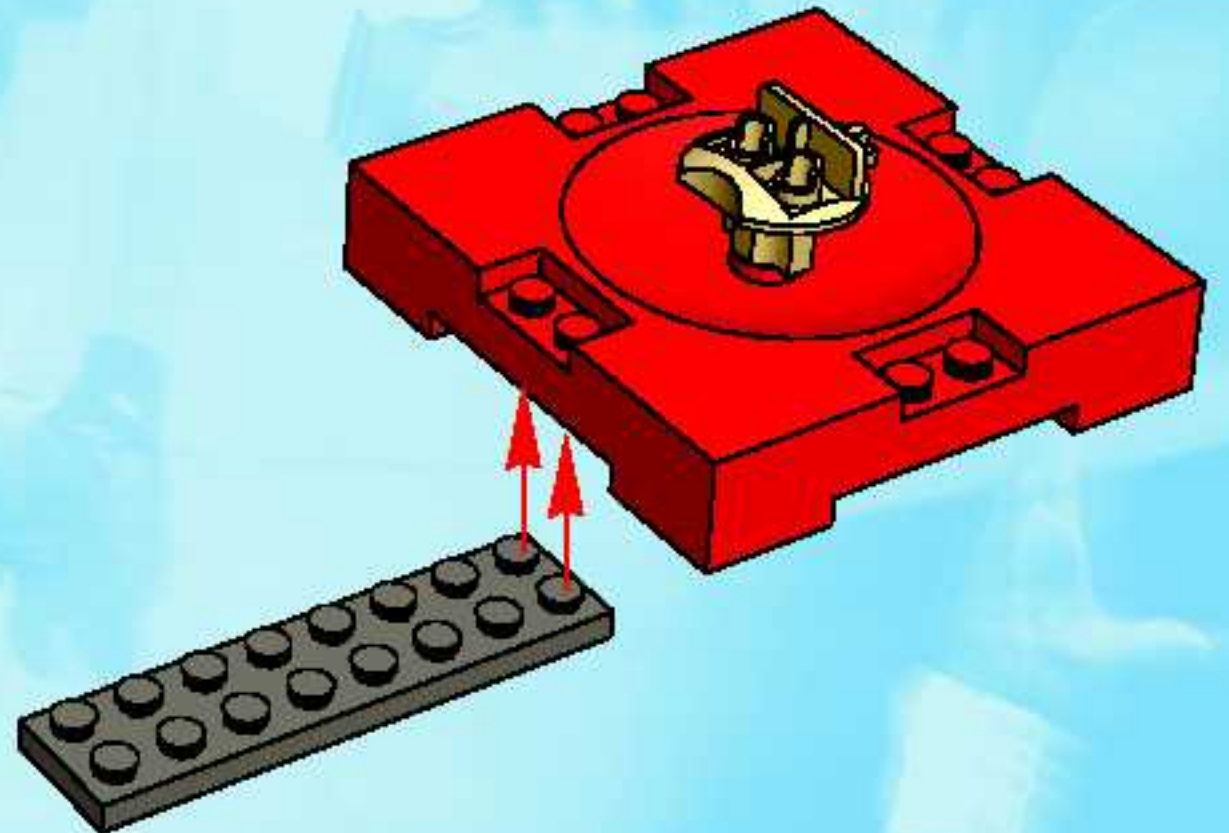

3

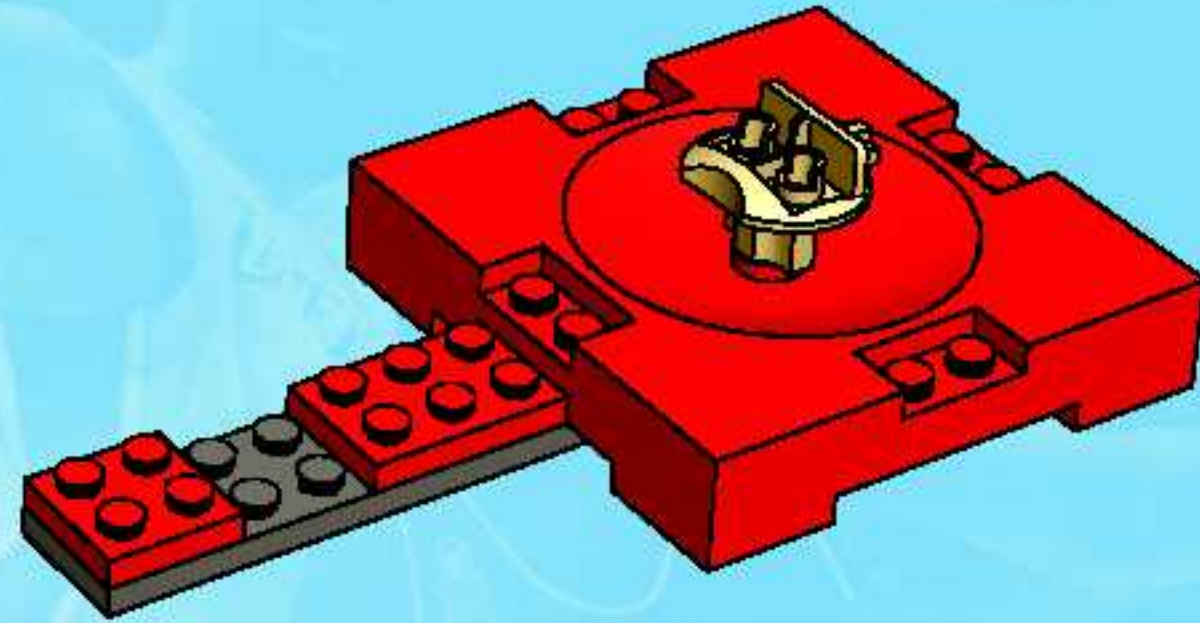

4

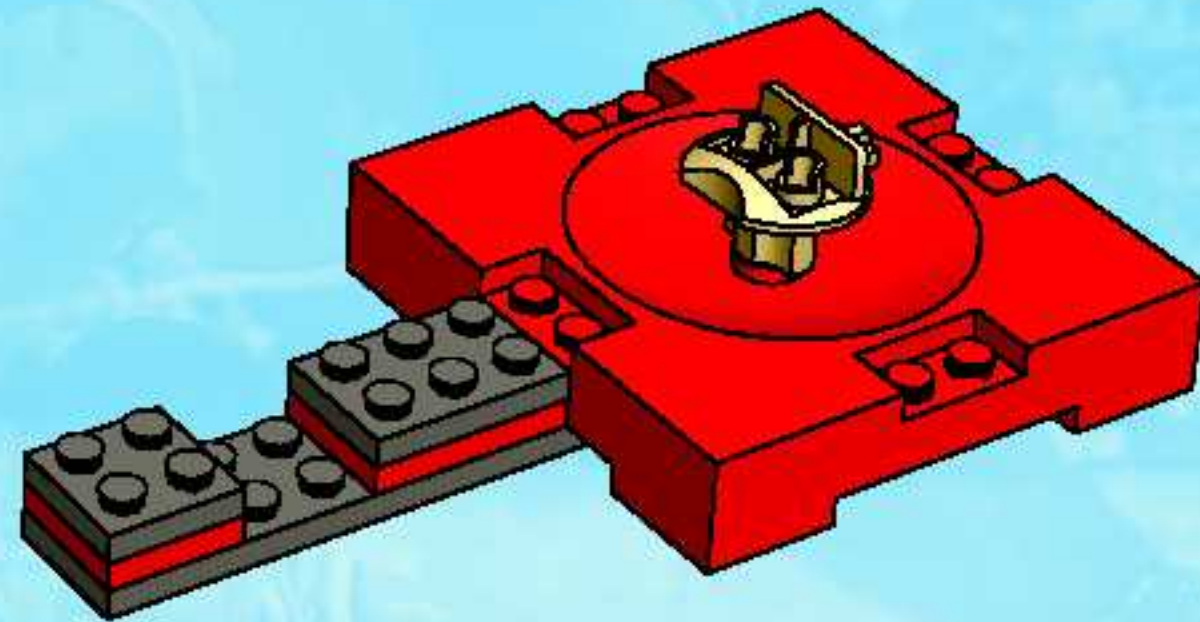

5

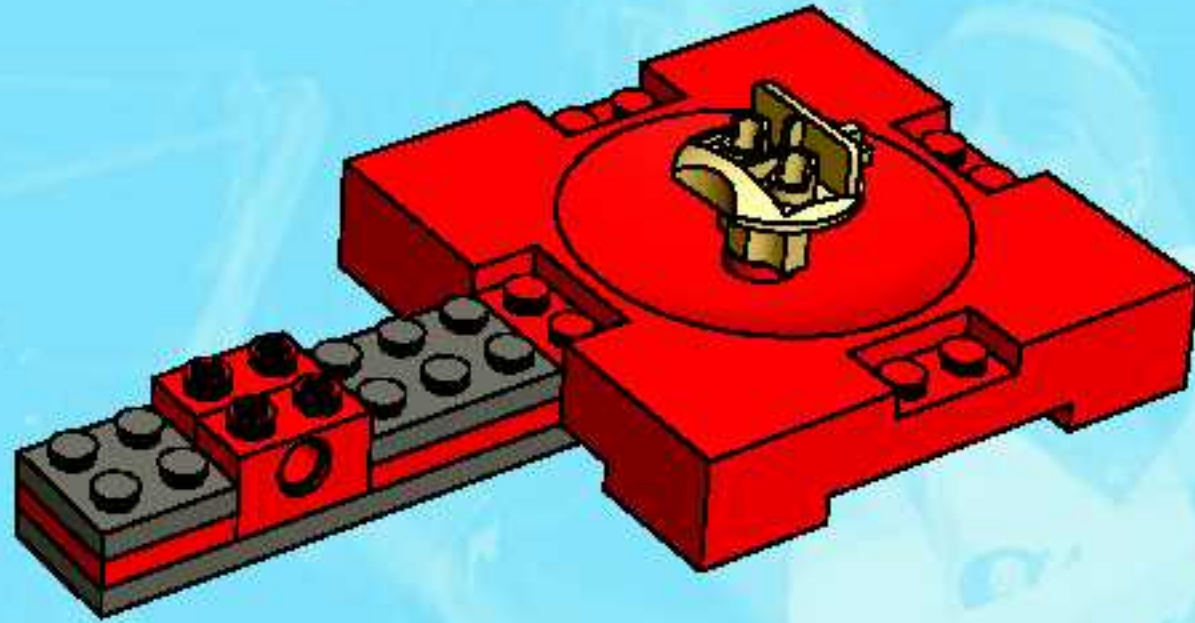

6

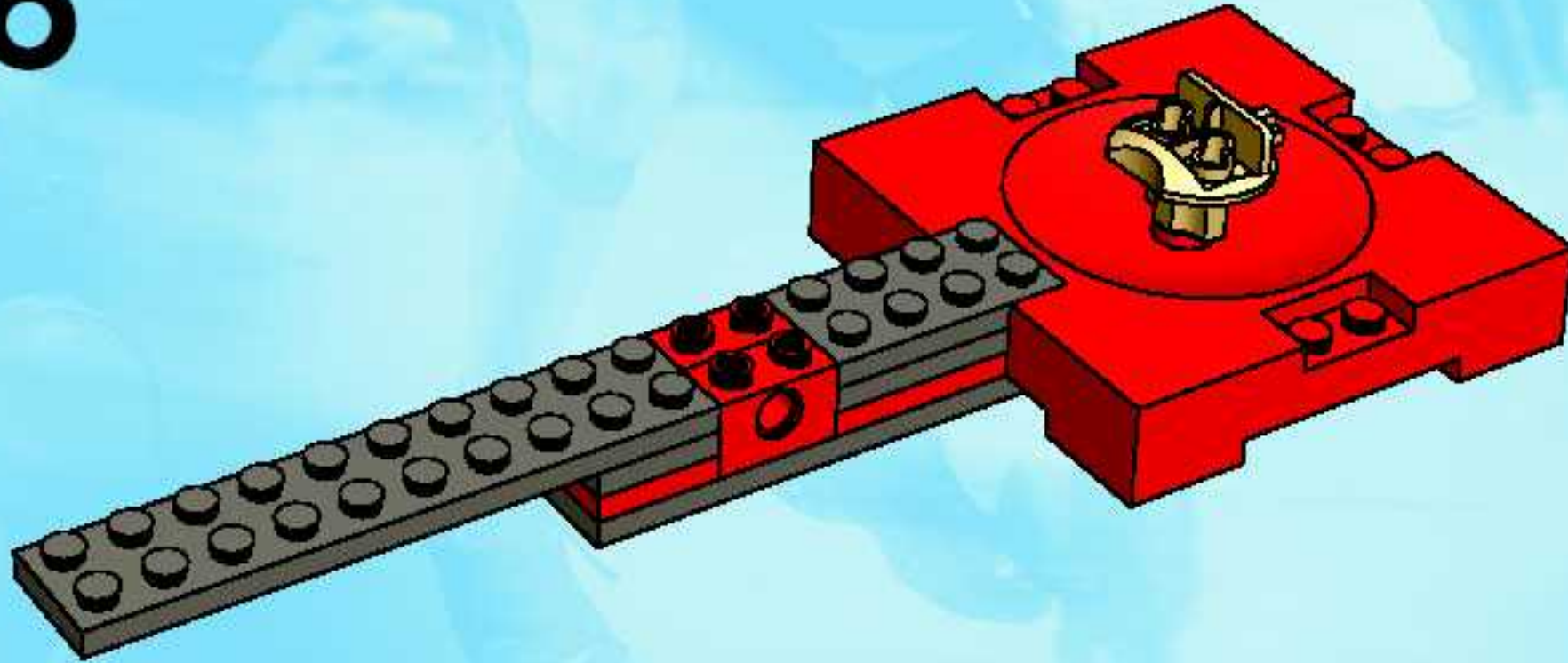



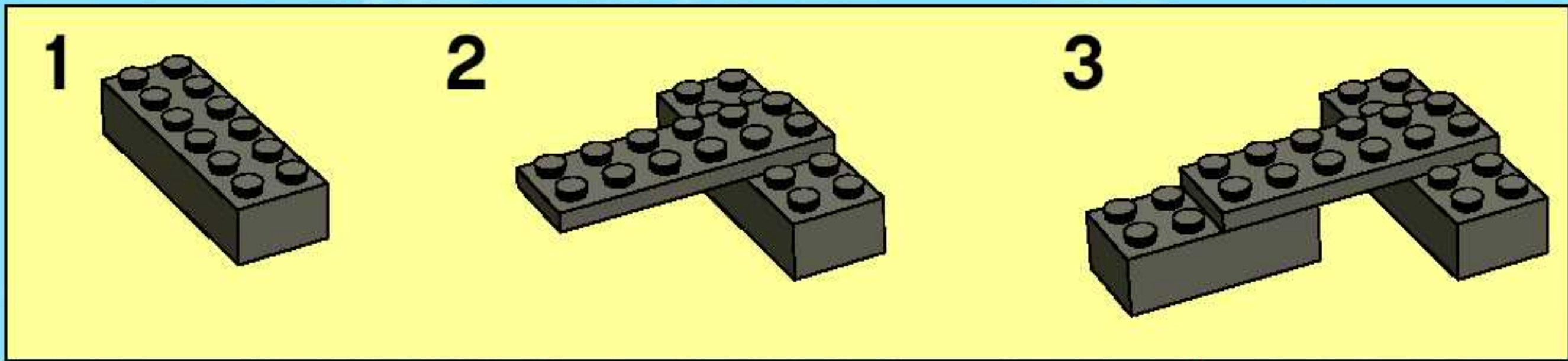

7

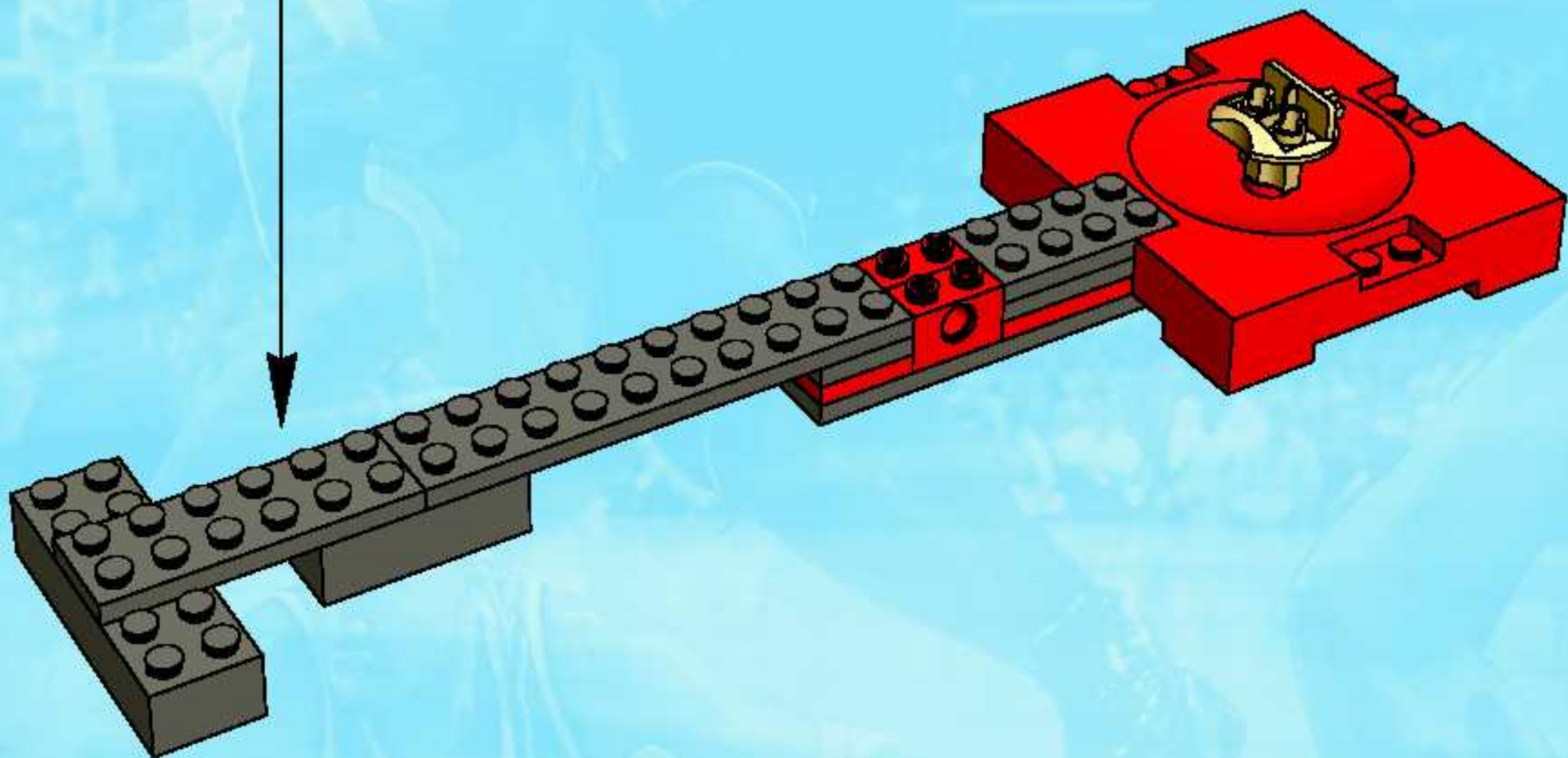

8

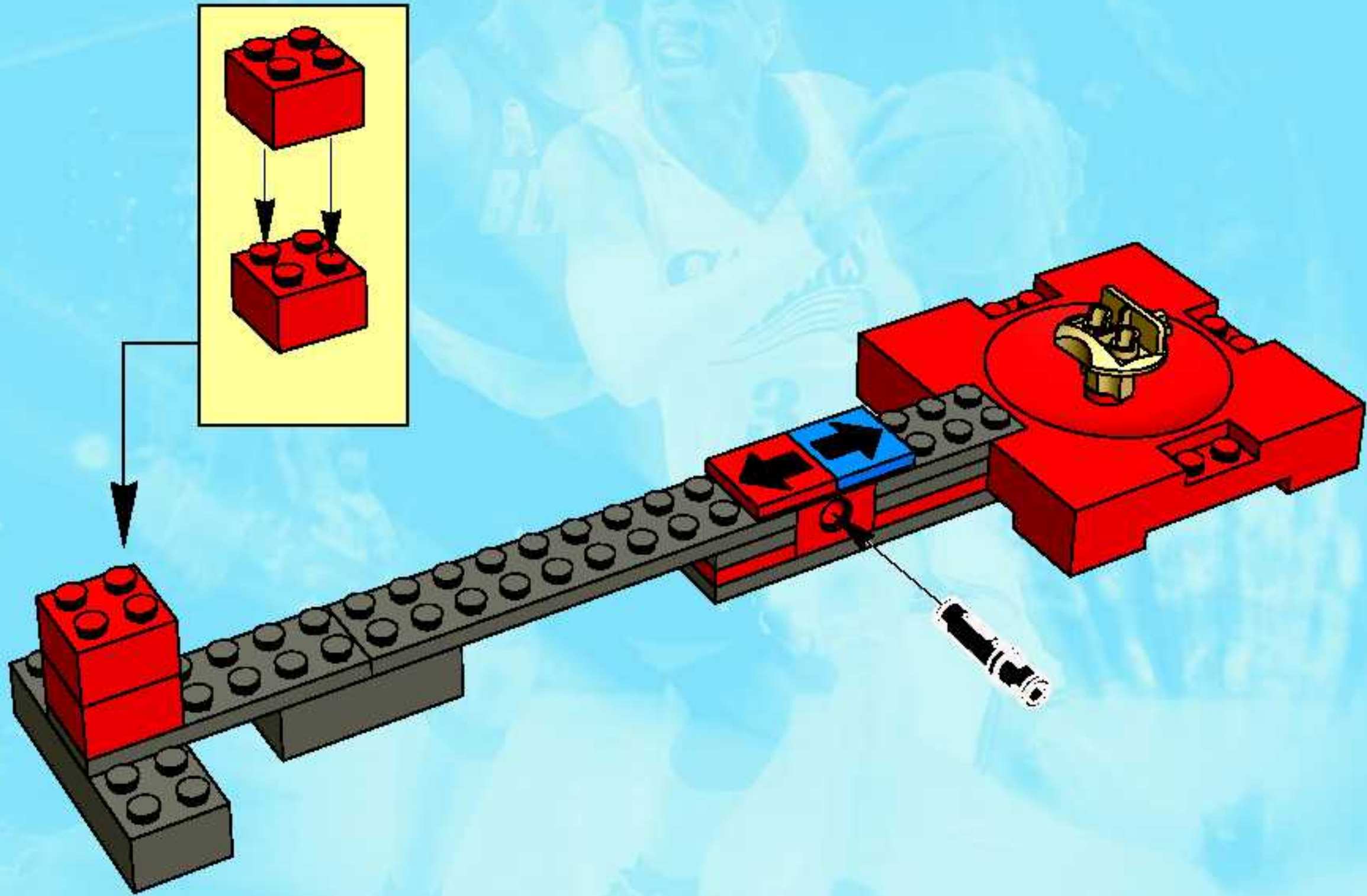

9

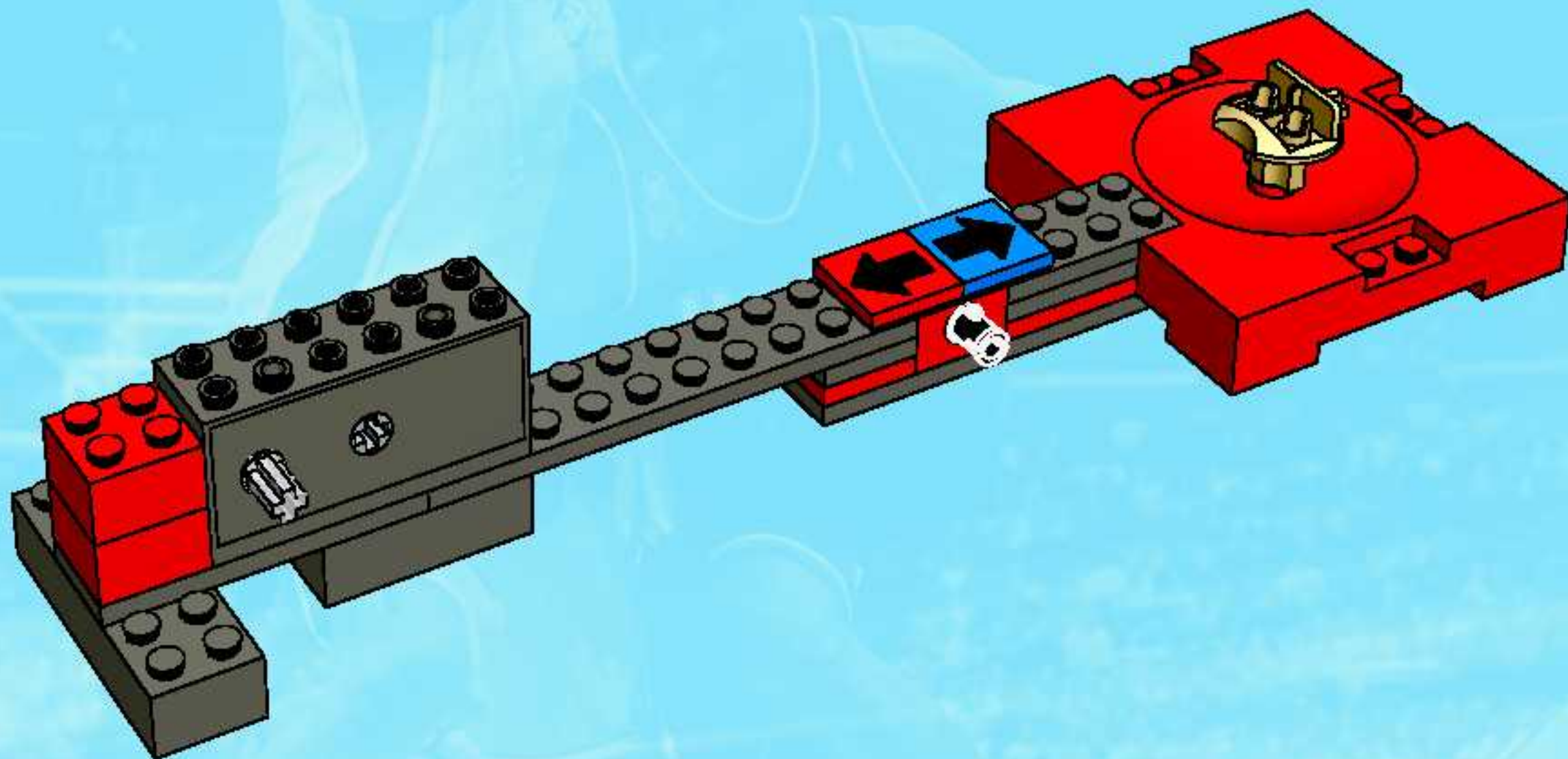

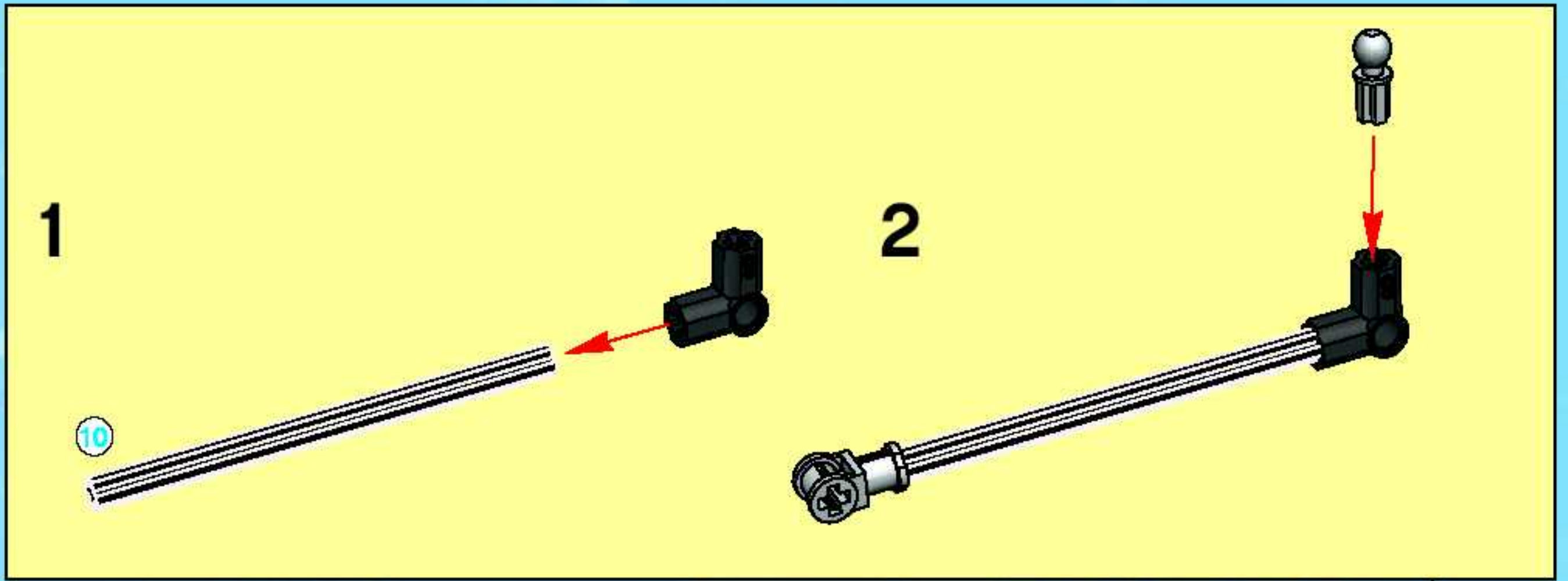

10

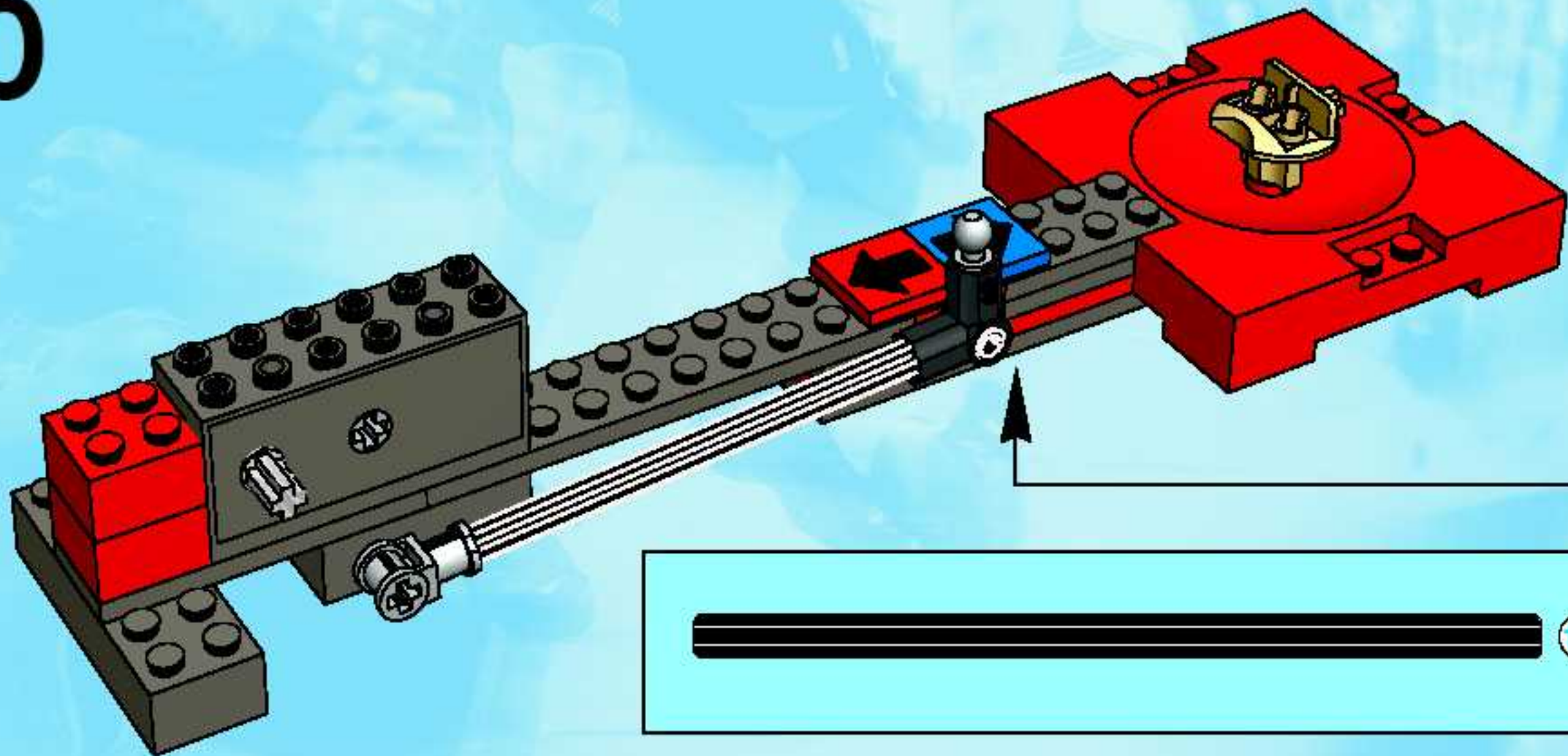

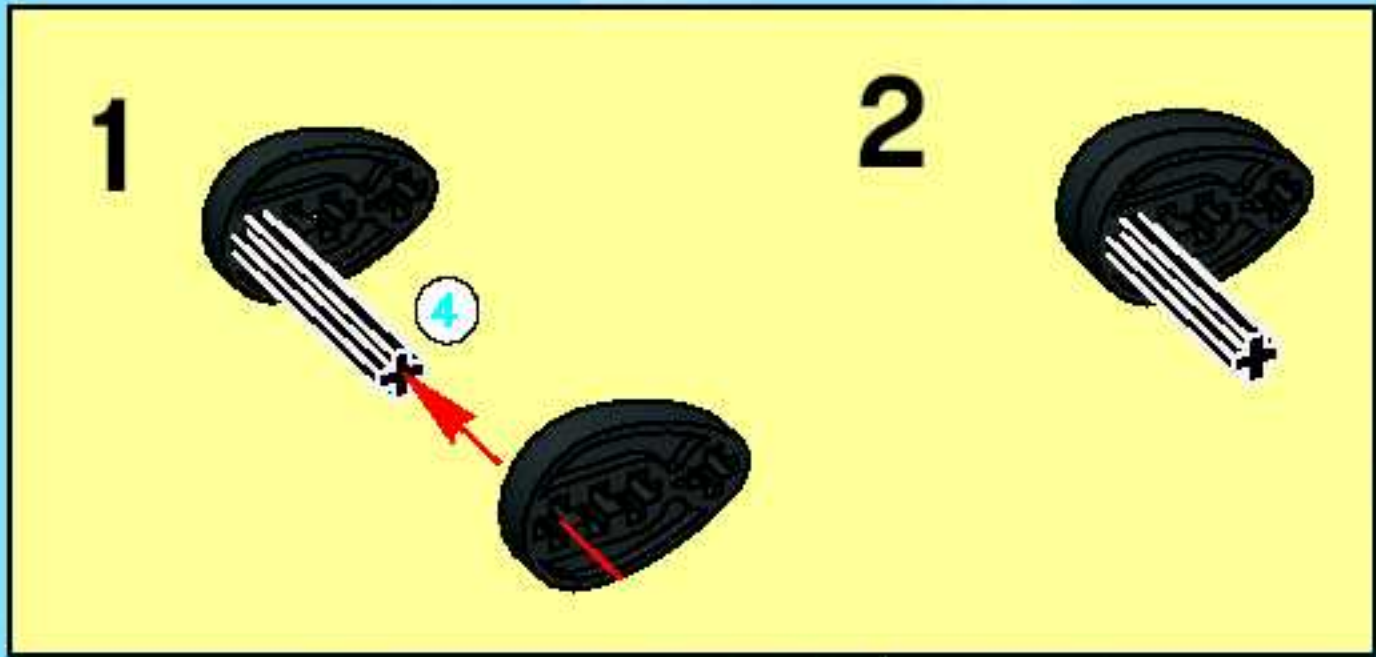

11

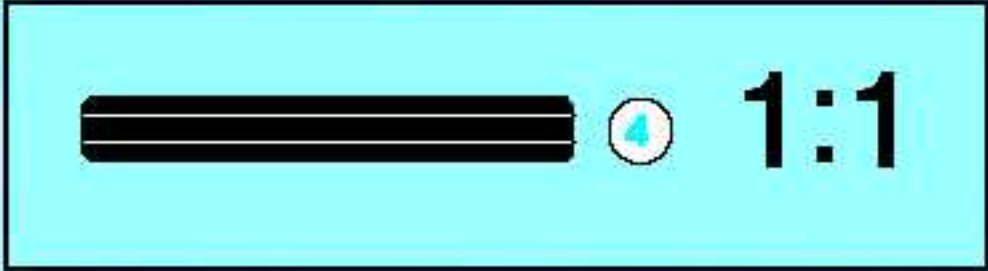
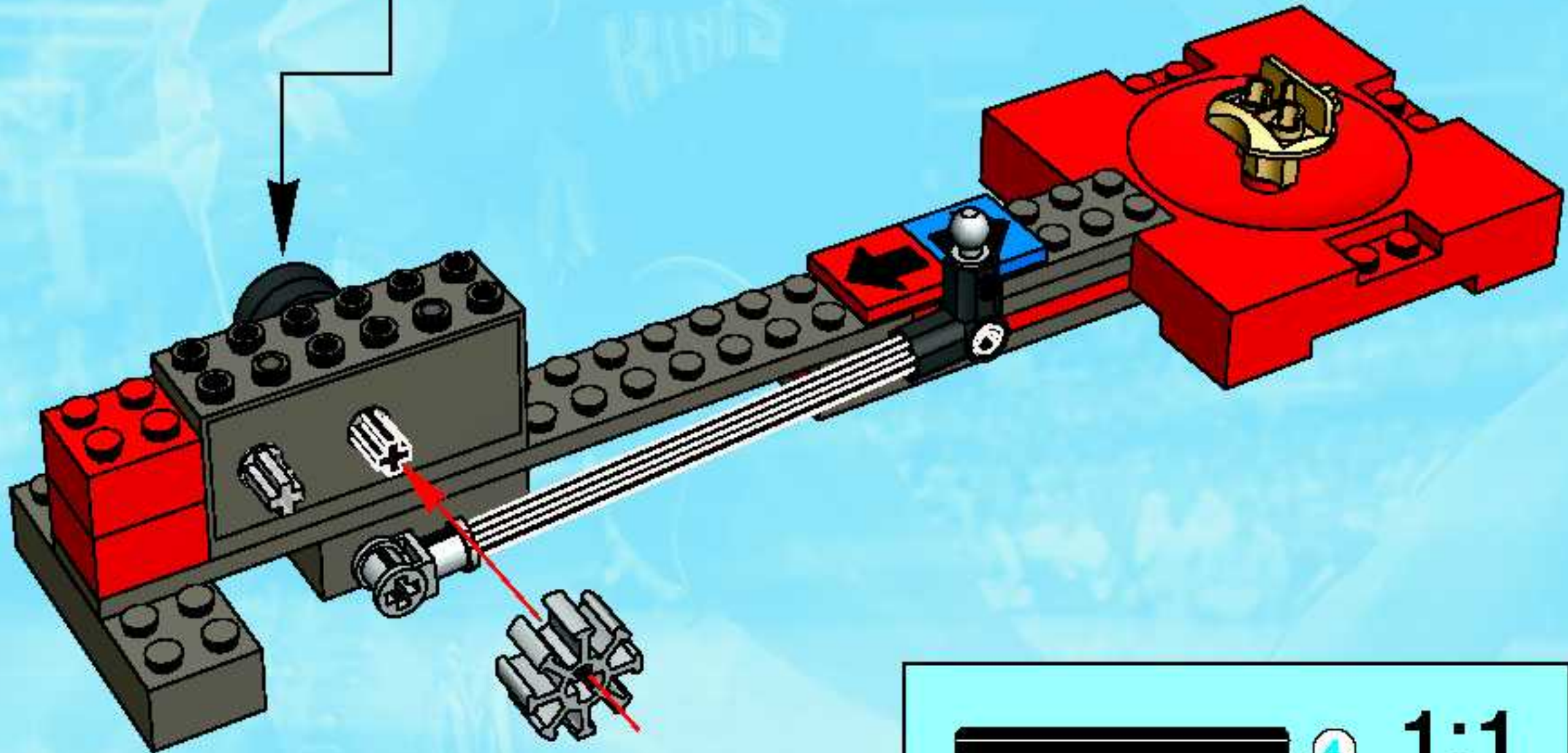

12

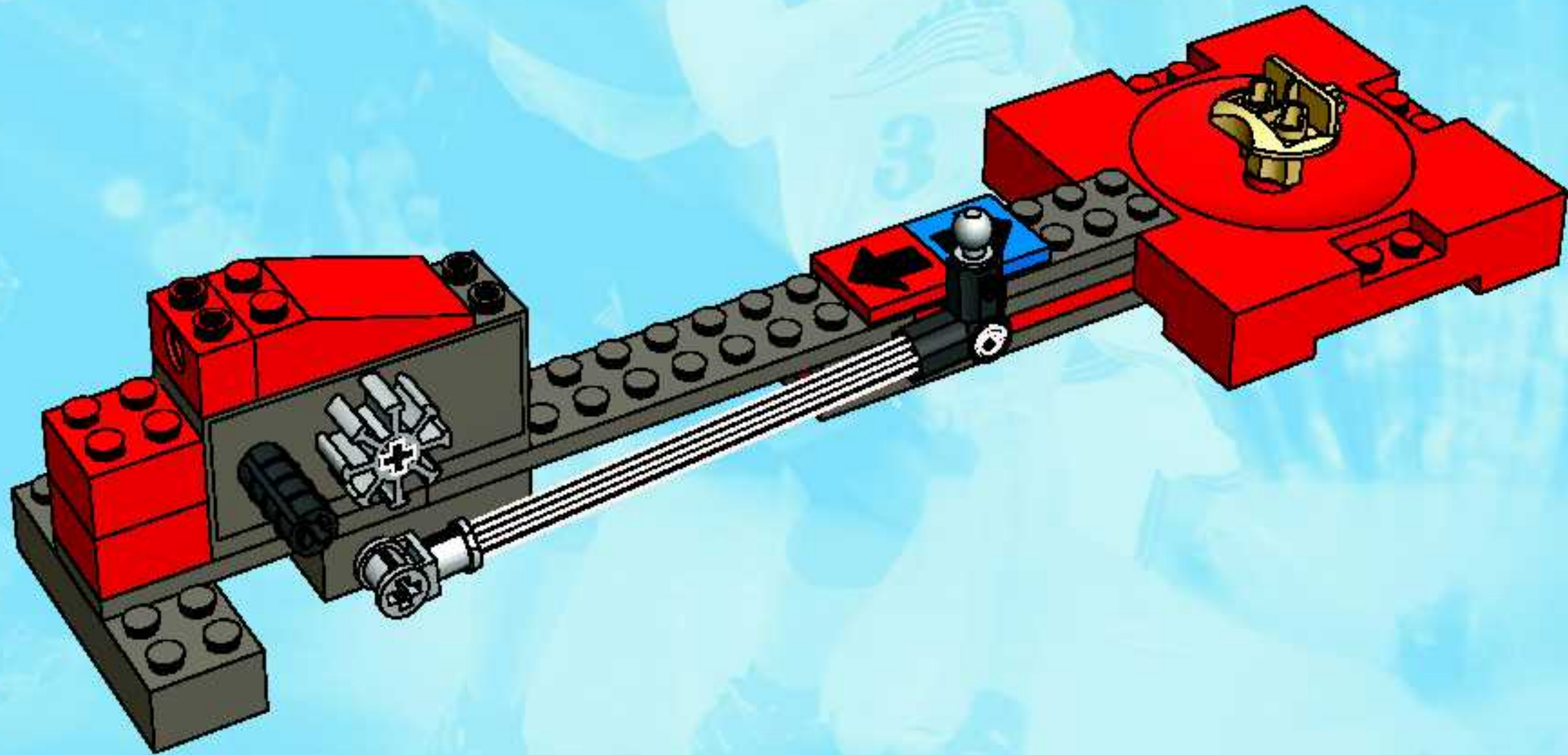

13

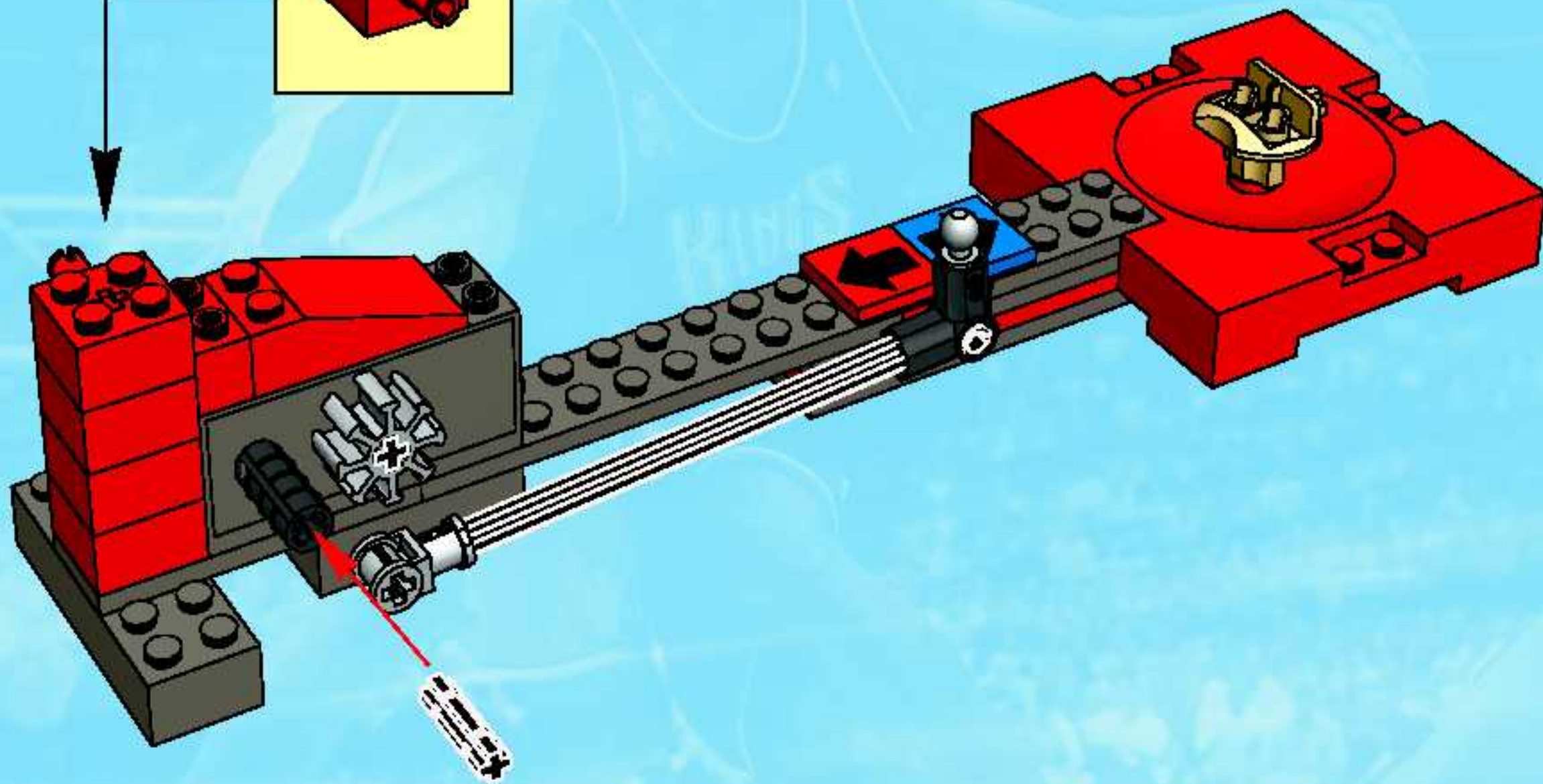
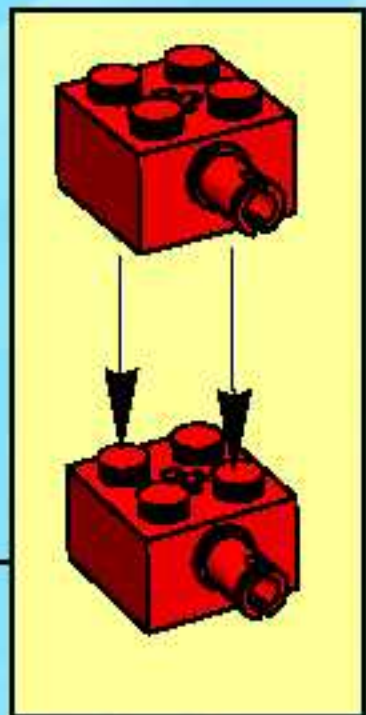

14

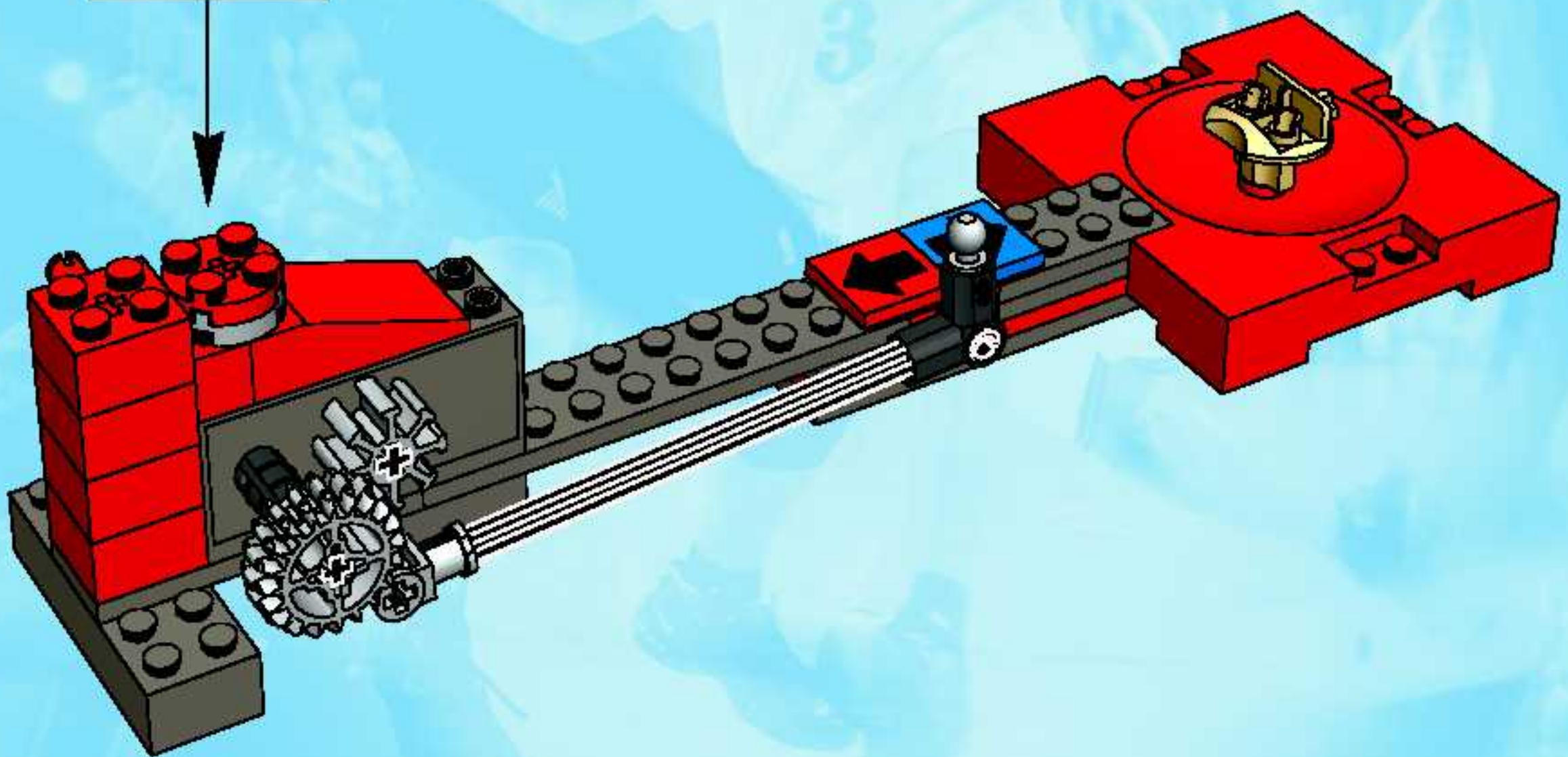
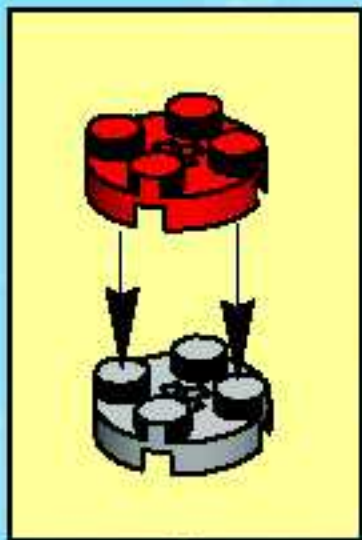



15

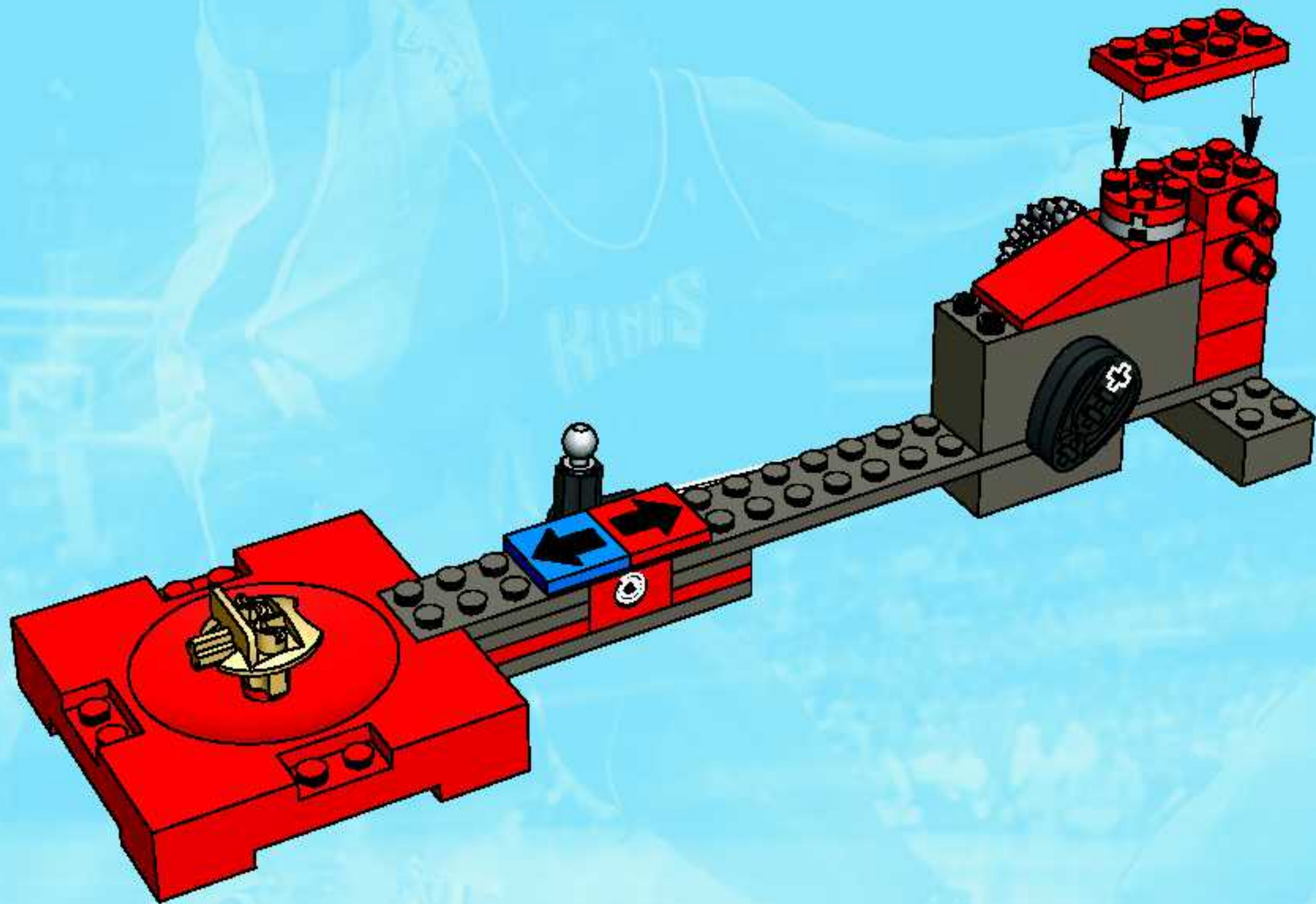

16

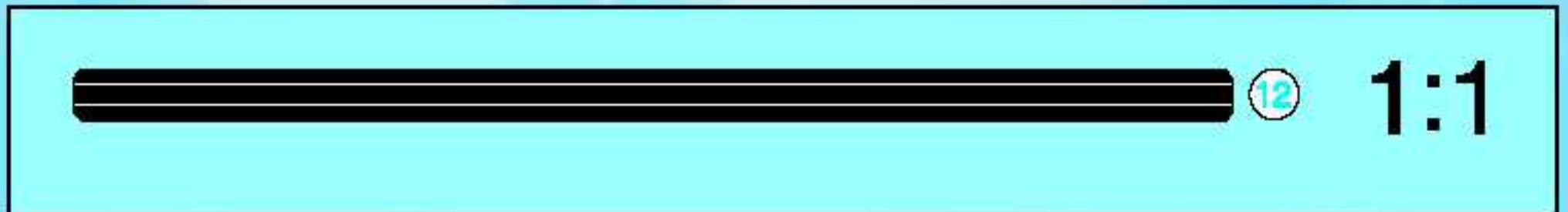
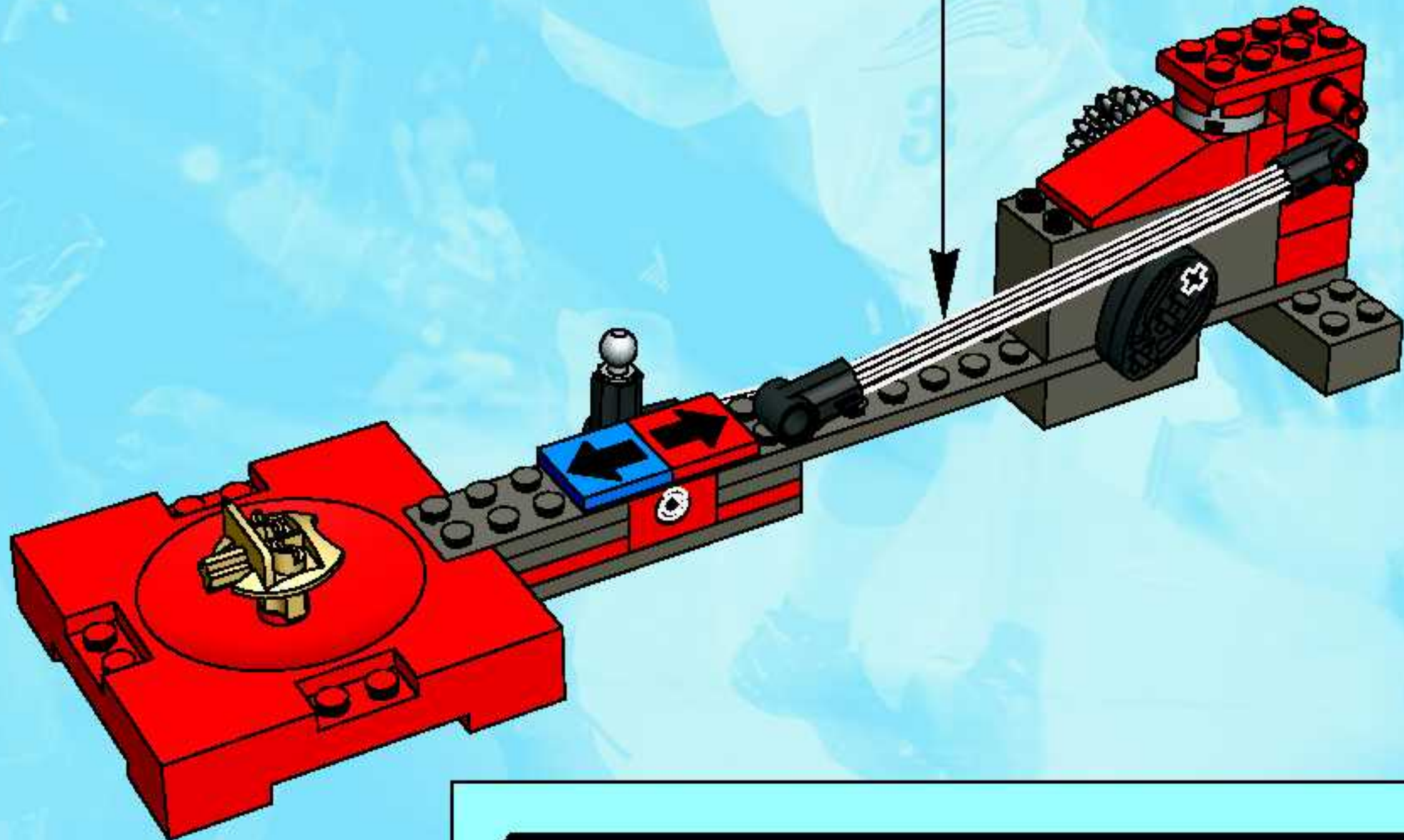
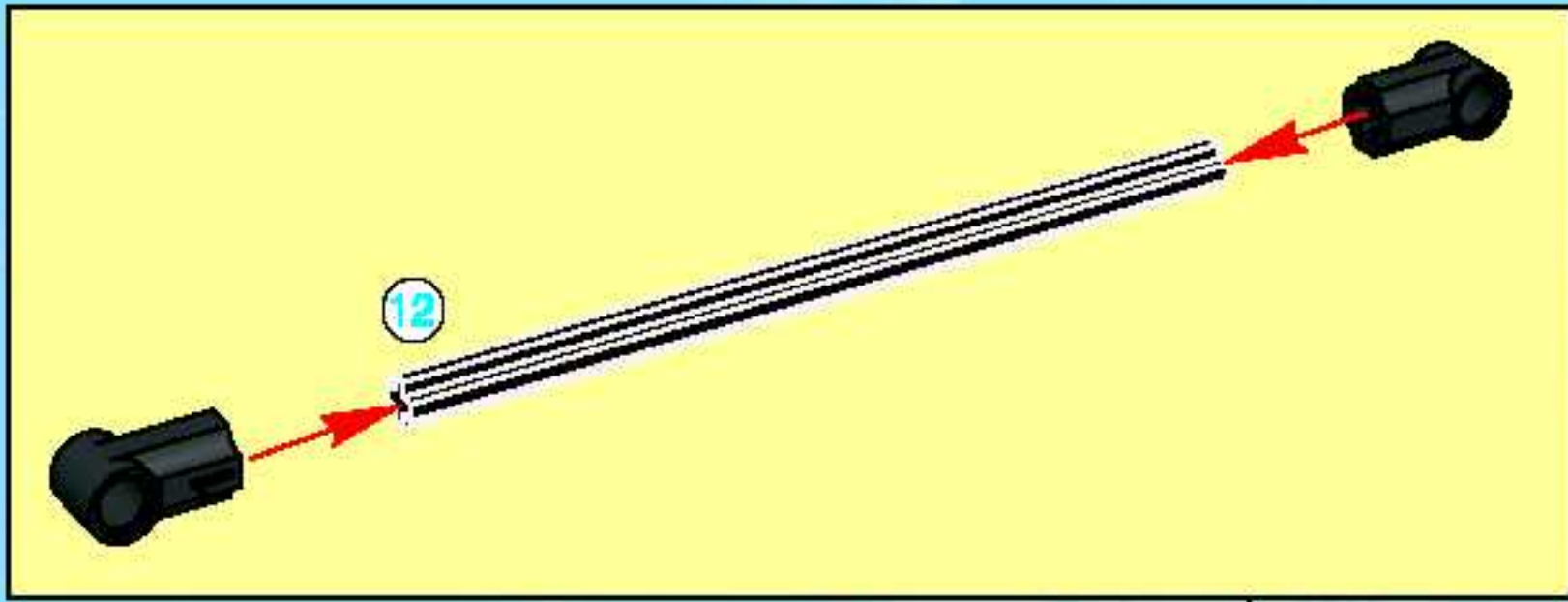

17

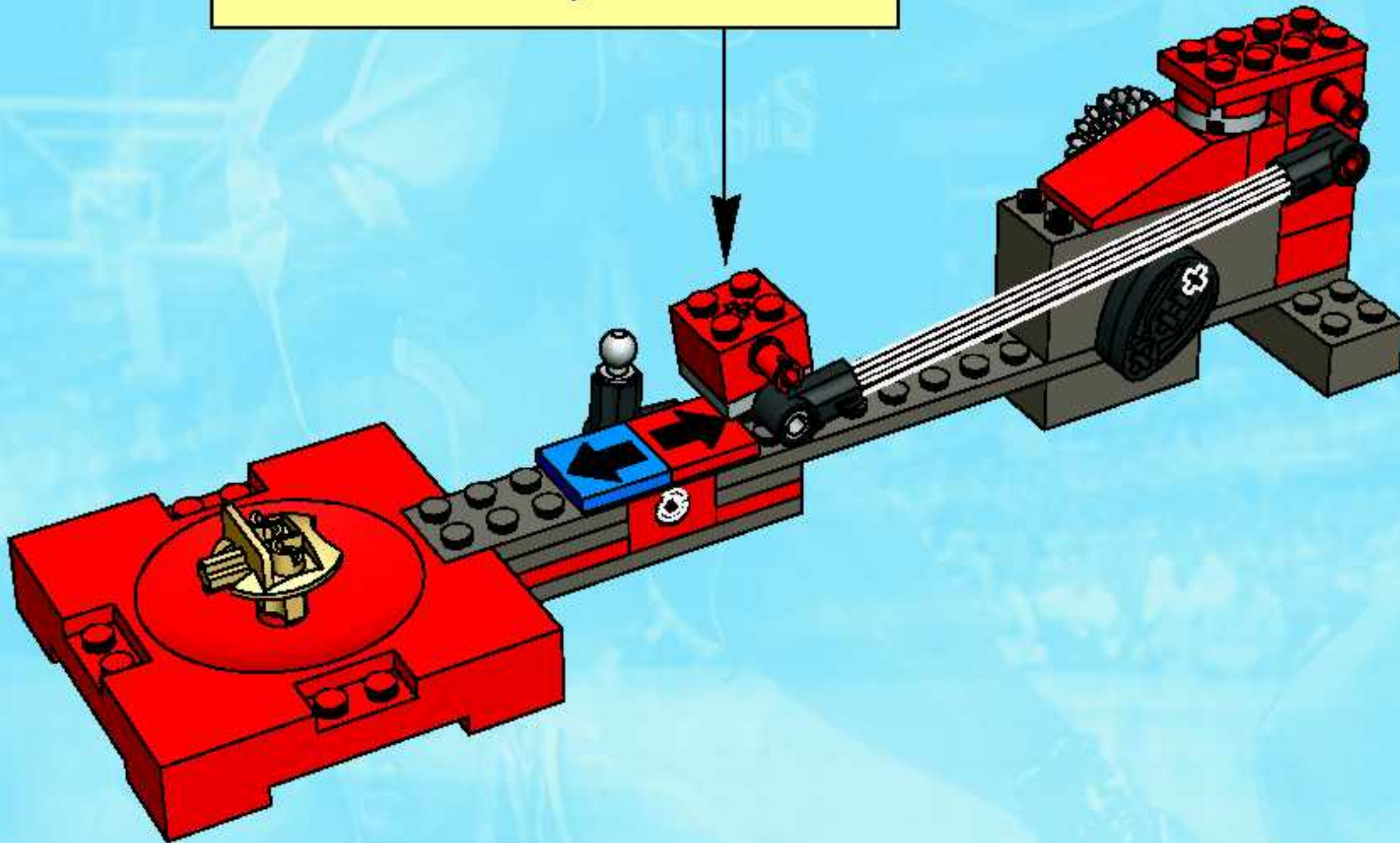
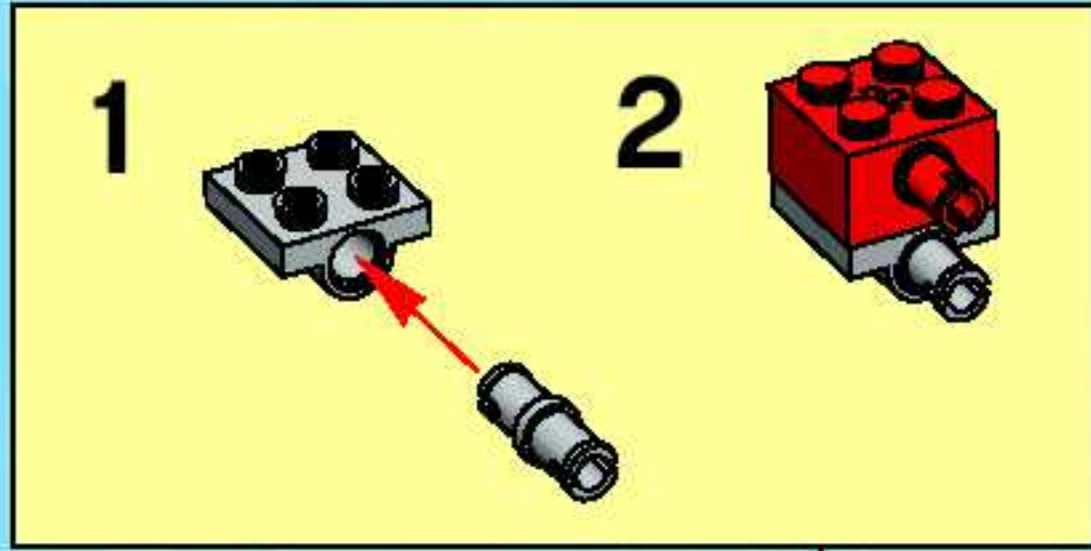

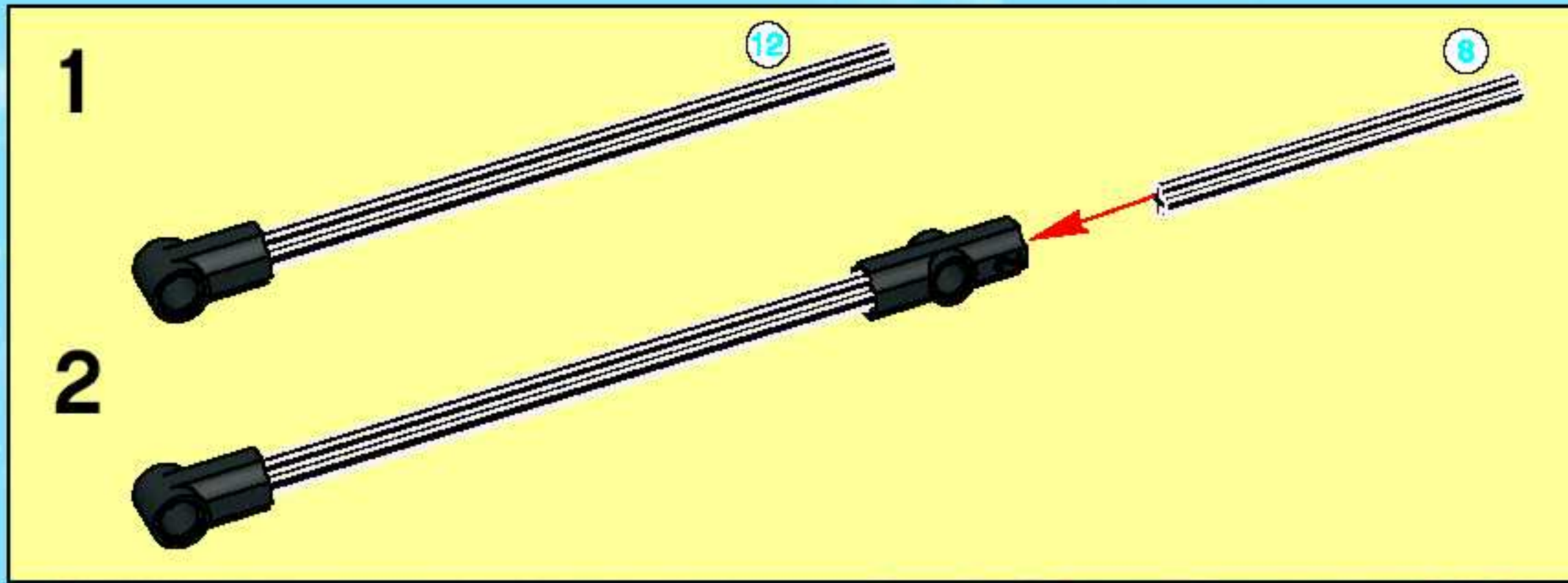

18

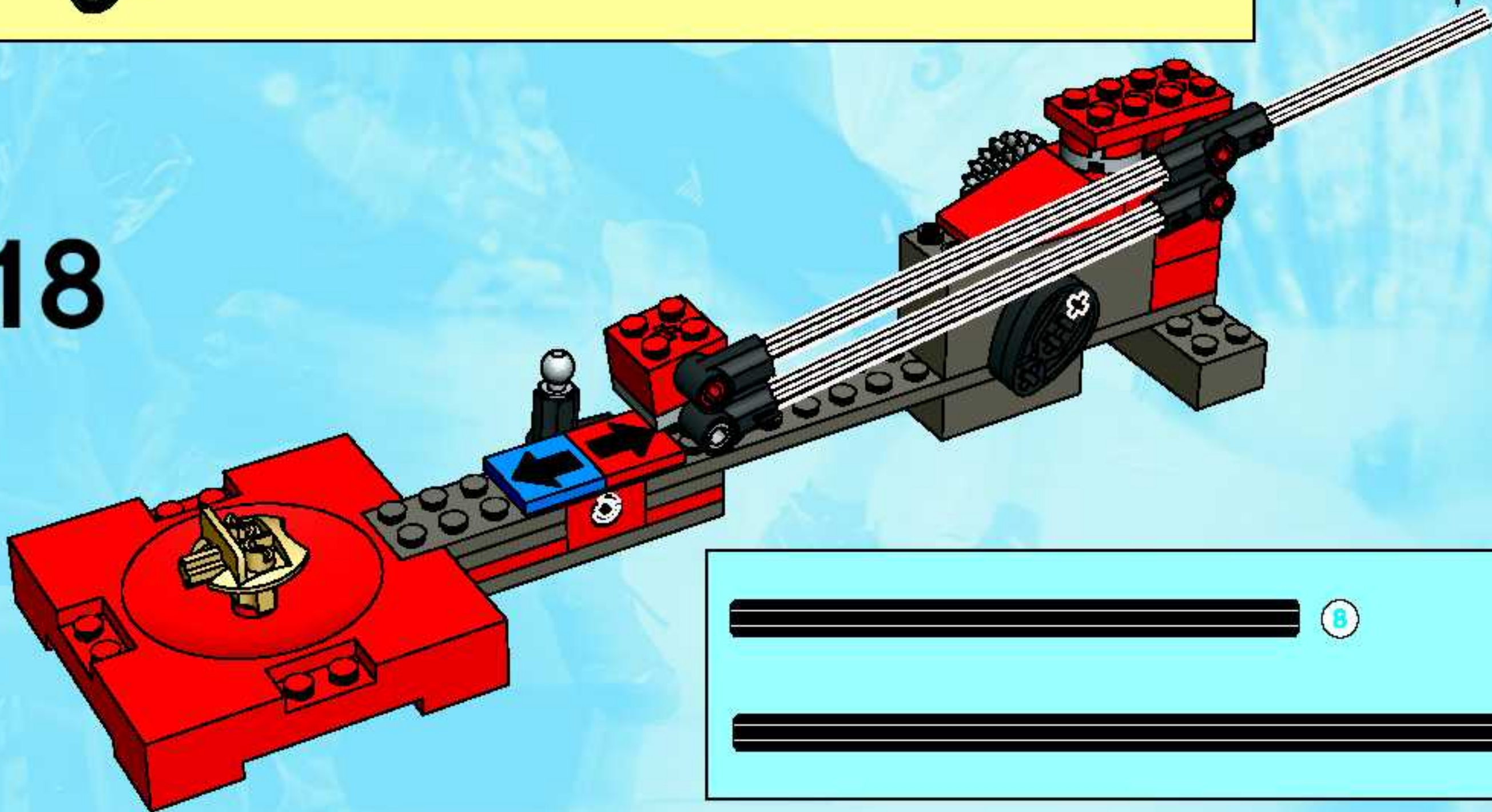



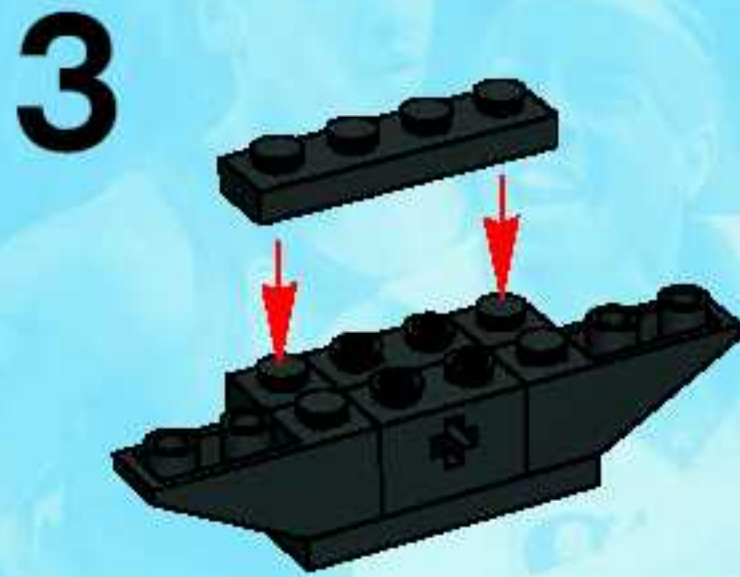
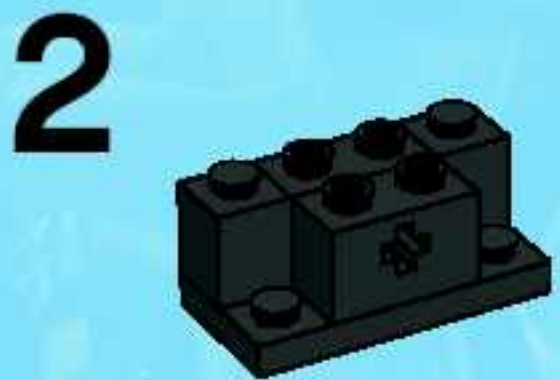
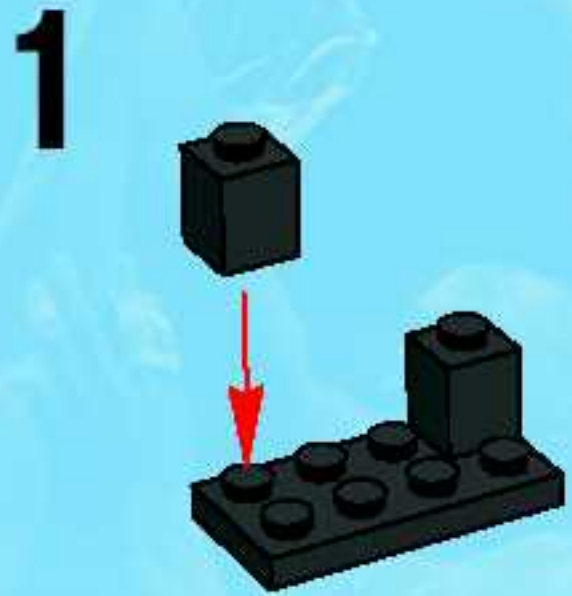











 [www.LEGO.com](http://www.LEGO.com)

**NBA**  **.COM**

 **NBA**



#3428



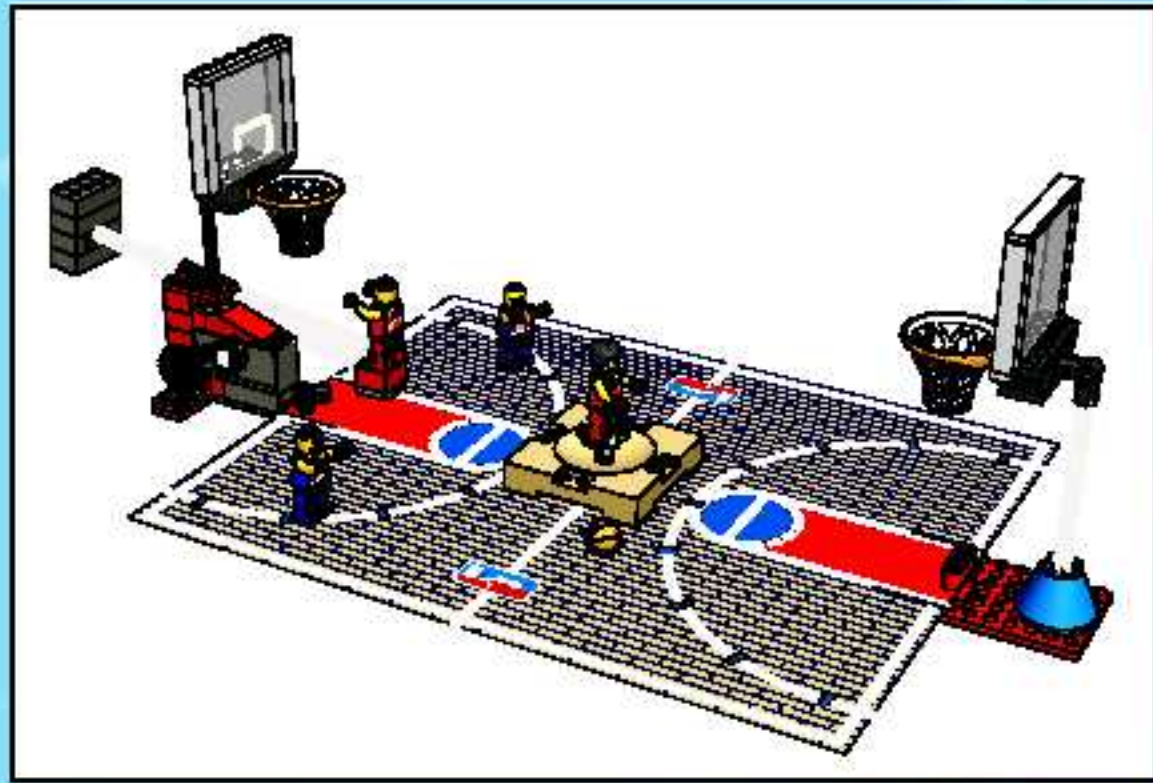

1

3428+3429

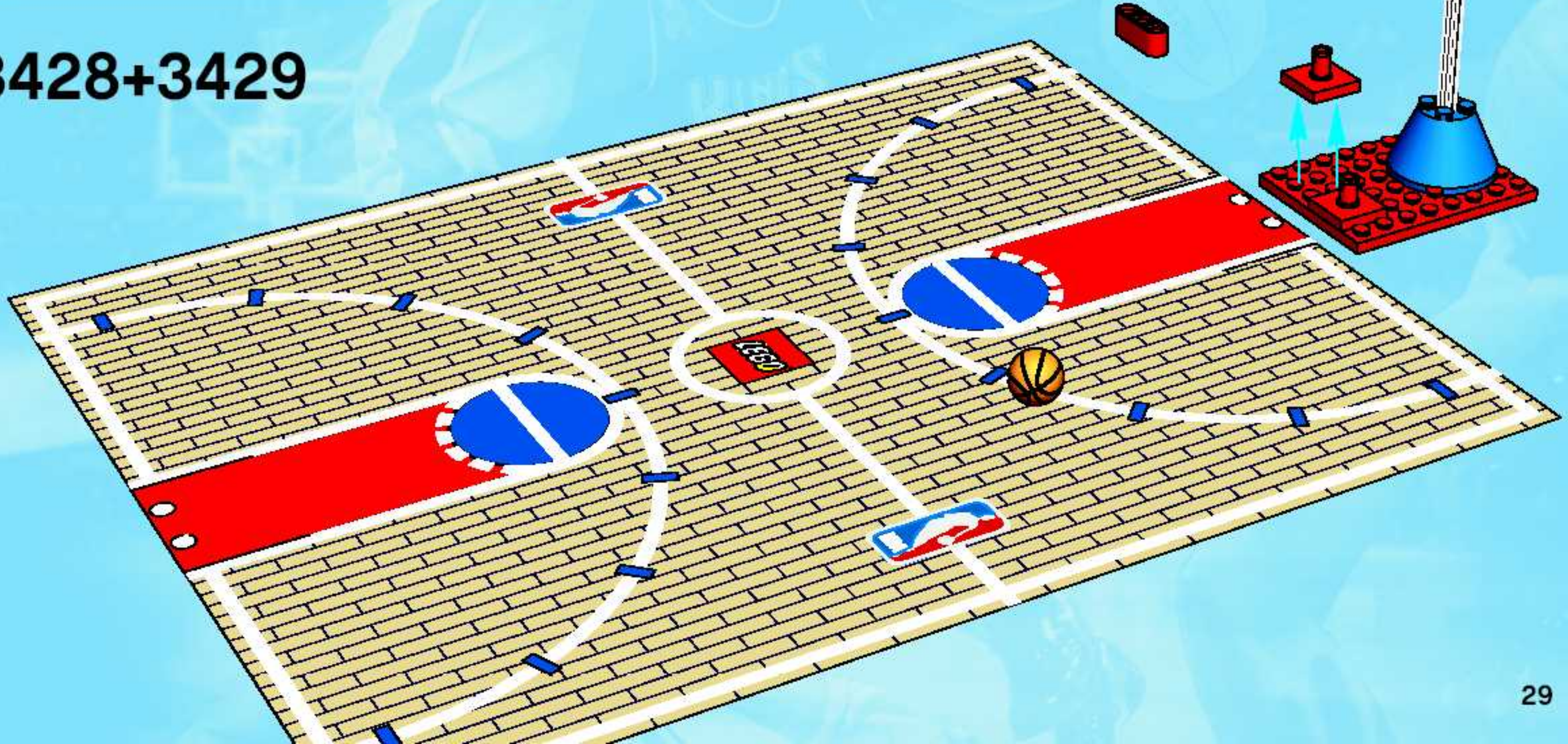

2

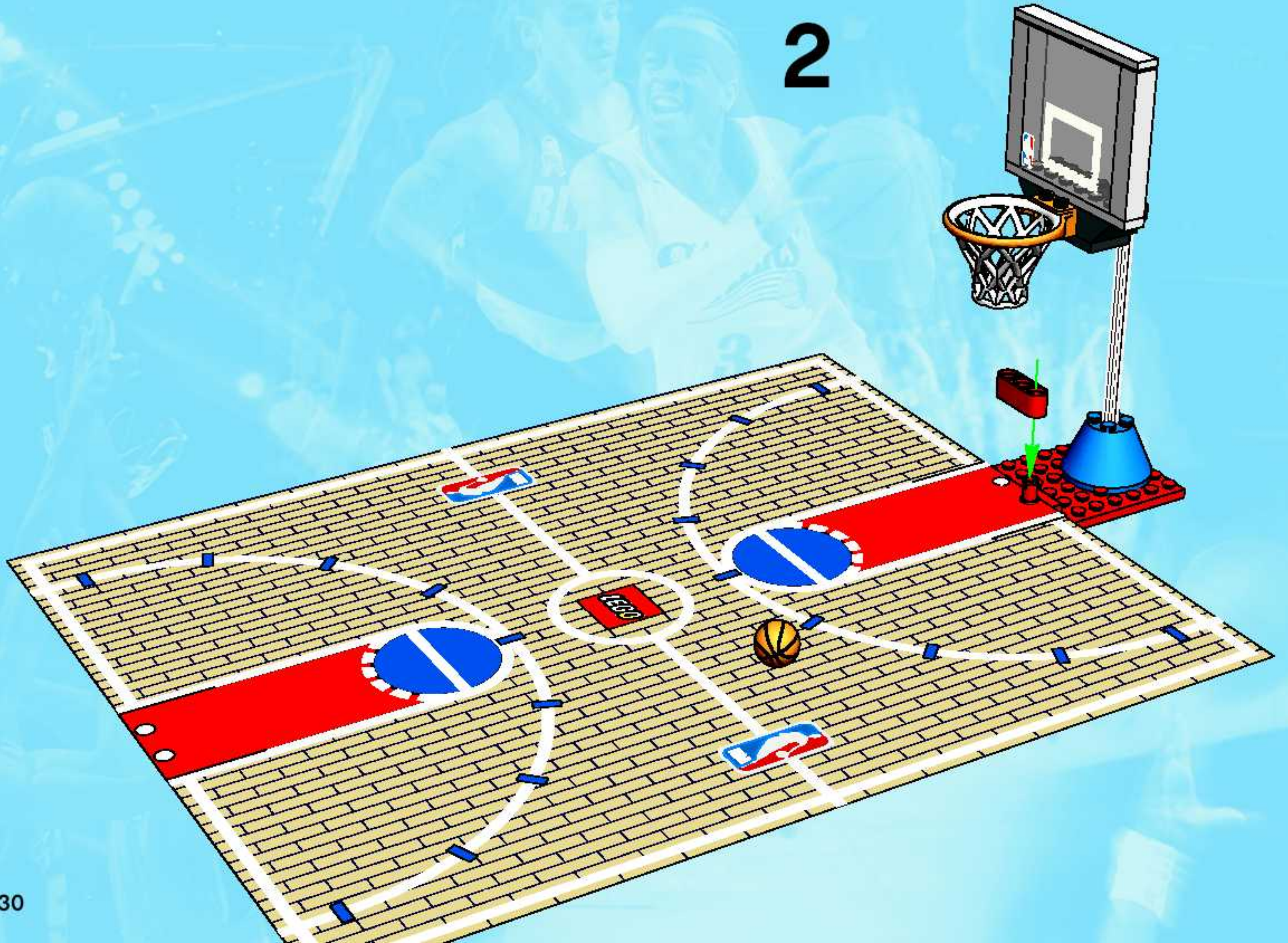



1

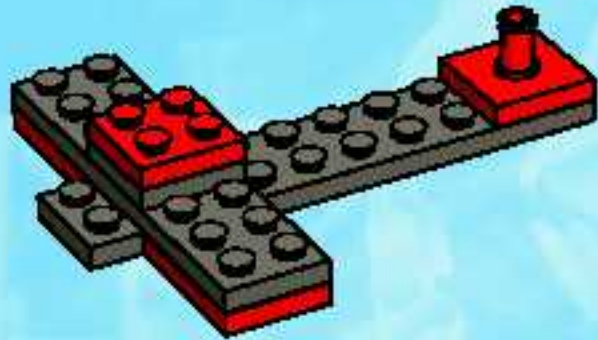

2

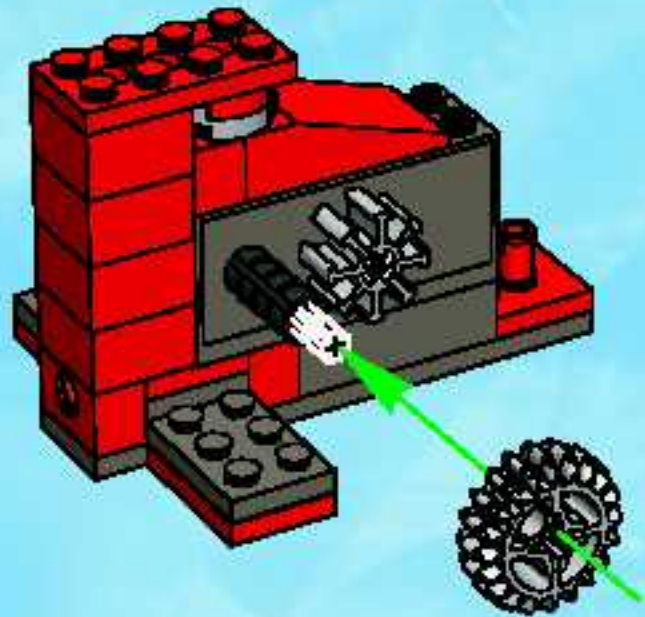

3



3





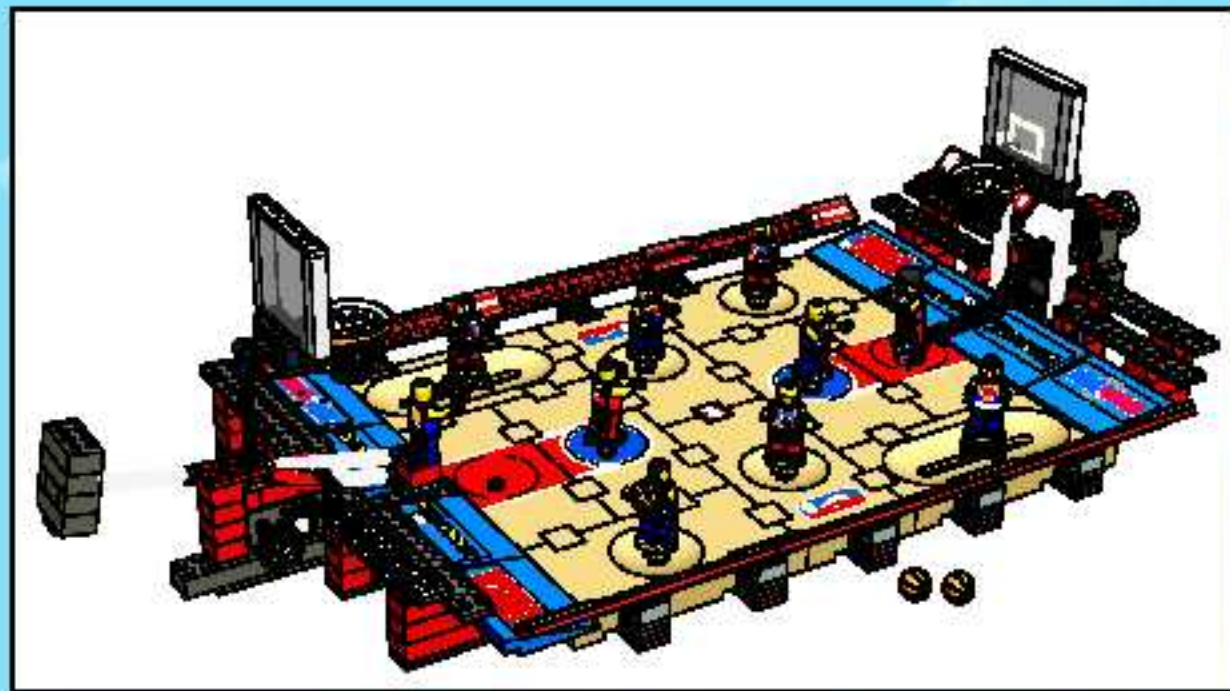

3429+3432

1

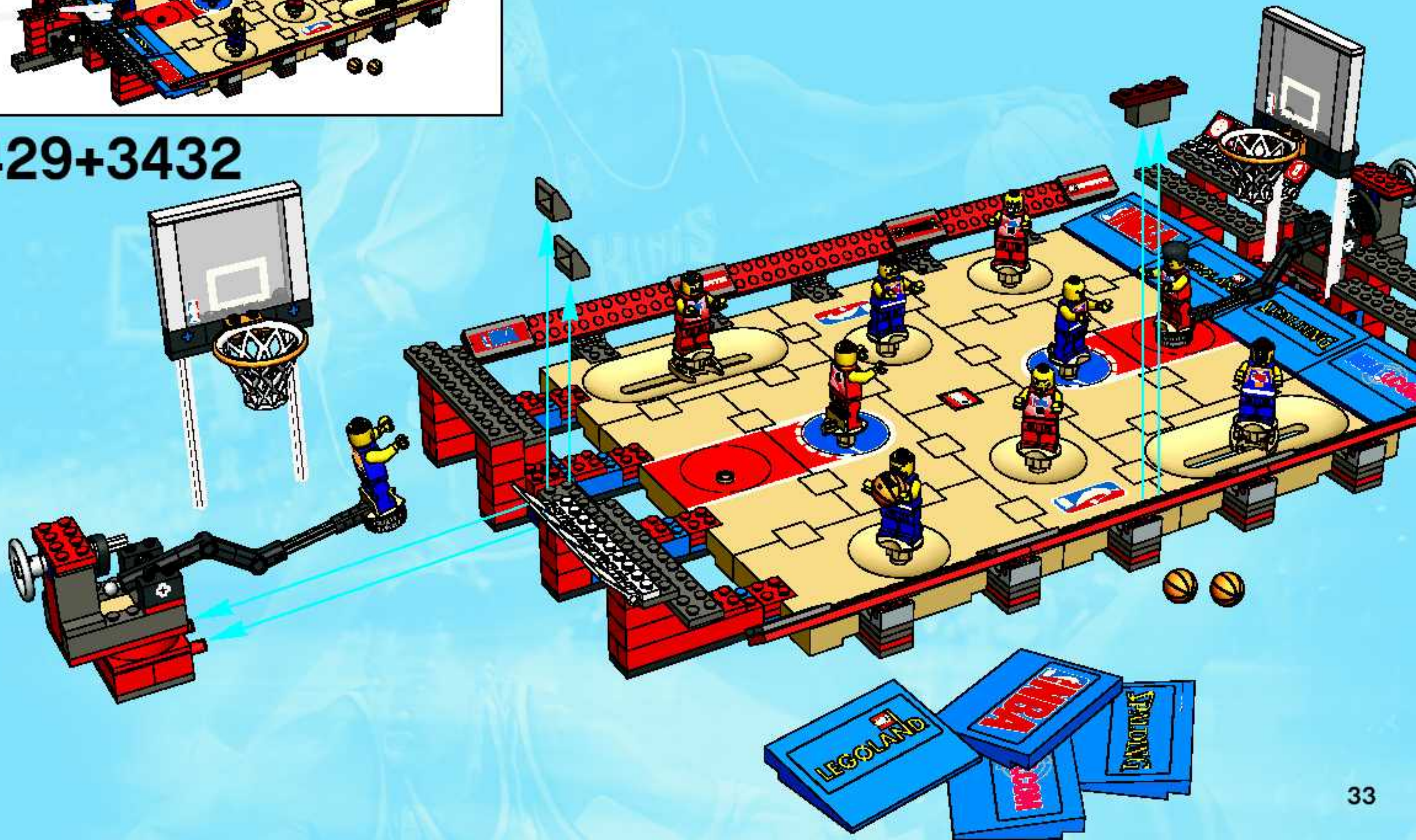

1

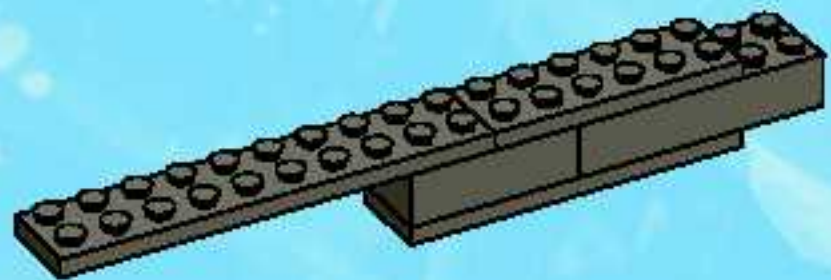

2

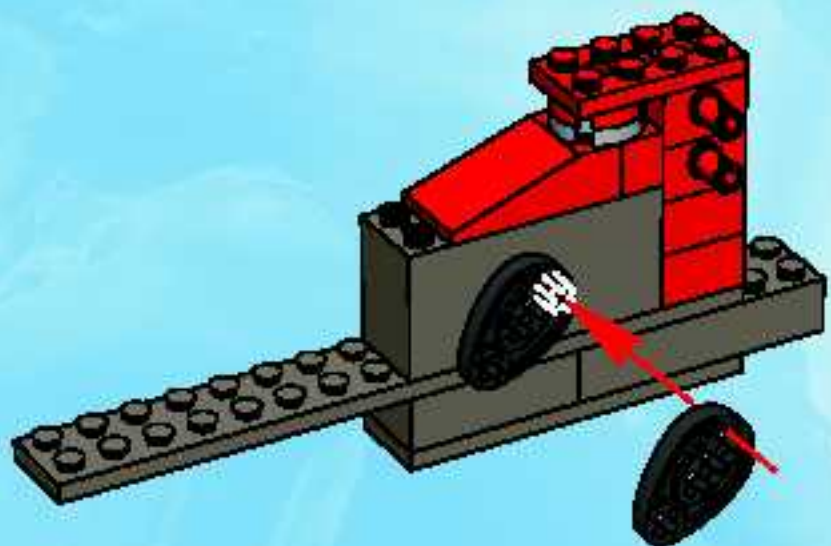

3

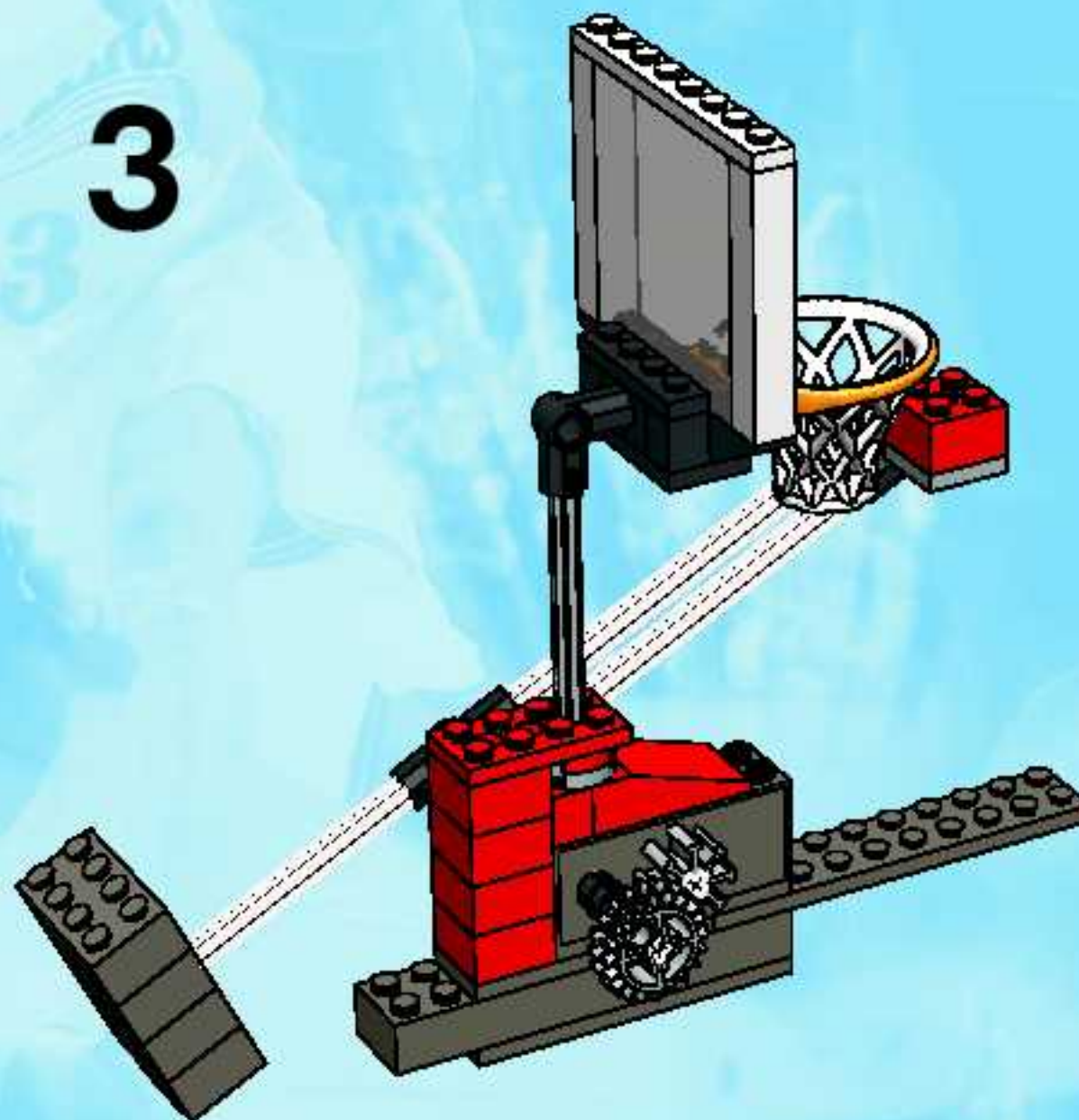

2

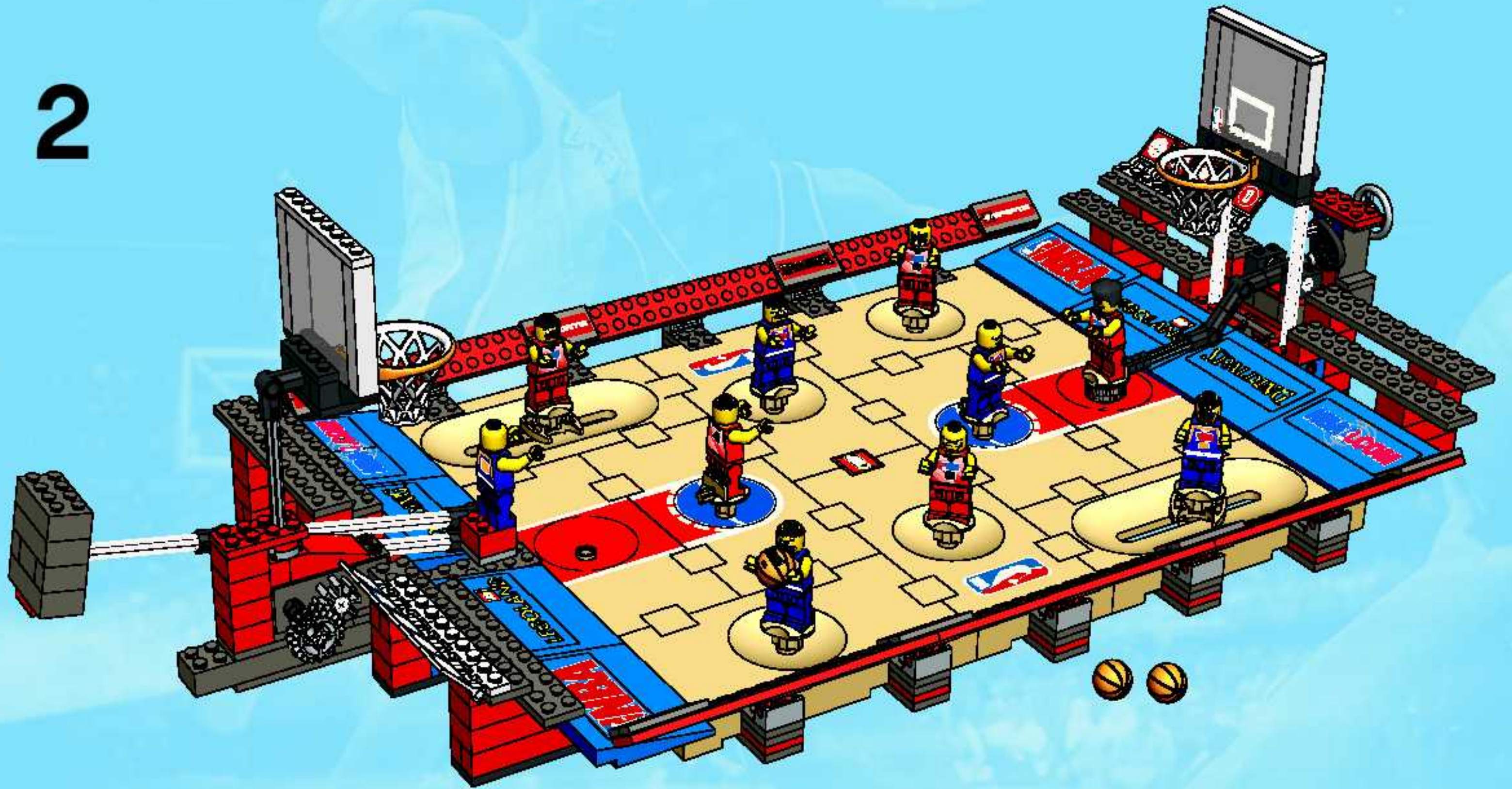

# LEGO SPORTS



adidas, the adidas logo and the three stripe trademark are registered trademarks of the adidas-Salomon group, used with permission. Fevernova and the Trigon logo are trademarks of the adidas-Salomon group, used with permission.

adidas, le logo adidas et la marque aux trois bandes sont des marques déposées du groupe adidas-Salomon, utilisées avec sa permission. Fevernova et le logo Trigon sont des marques déposées du groupe adidas-Salomon, utilisées avec sa permission.

adidas, el logotipo adidas y el símbolo de tres bandas son marcas registradas del grupo adidas-Salomon y se utilizan con autorización. Fevernova y el logotipo Trigon son marcas registradas del grupo adidas-Salomon y se utilizan con autorización.

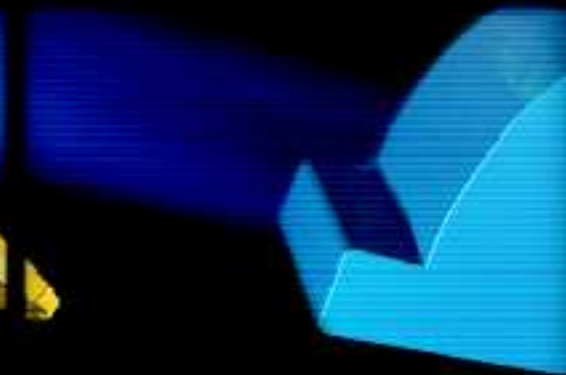

NBA identifications depicted are the exclusive property of NBA Properties, Inc. and/or the NBA Member Teams, and are used with permission.

Les identifications NBA reproduites sont la propriété exclusive de NBA Properties, Inc. et/ou des équipes membres de la NBA et sont reproduites sous autorisation.



SPALDING is a trademark of/est une marque de commerce de/ es una marca registrada de Spalding Sports Worldwide, Inc. or/ou/ o Lisco Sports, Inc., a Spalding affiliate/une filiale de Spalding/un afiliado de Spalding. ©Spalding Sports Worldwide, Inc. 2003.

Las identificaciones retratadas de la NBA son propiedad exclusiva de NBA Properties, Inc. y/o de los miembros de los equipos de la NBA, y son usados bajo permiso.

LEGO and the LEGO logo are trademarks of/son des marques de commerce de/ son marcas registradas de LEGO Group. ©2003 The LEGO Group.

 [www.LEGO.com](http://www.LEGO.com)

