



Friends



3189





Andrea



Mia



Stephanie



Friends



Olivia



Emma

1

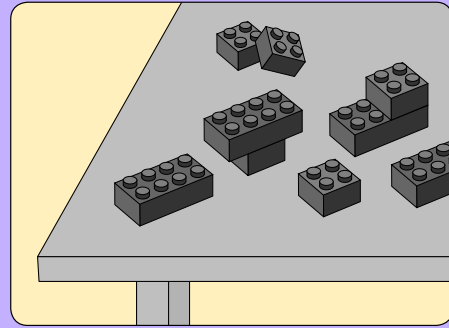
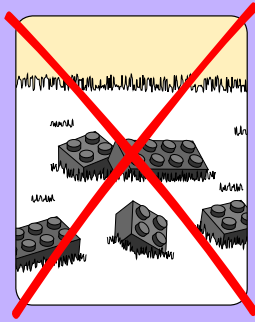

2

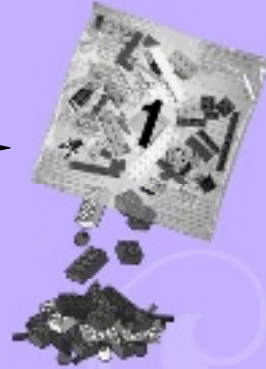

<http://lego.com/brickseparator>



+



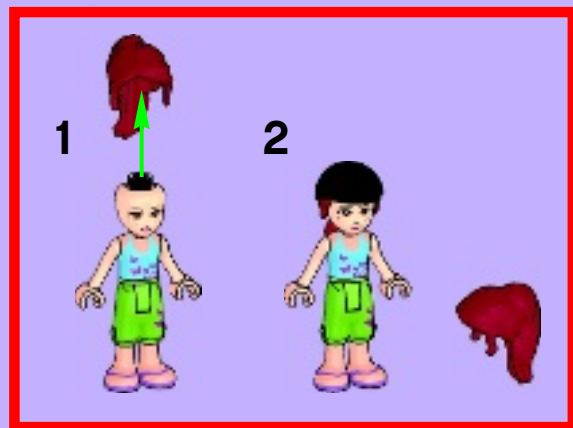
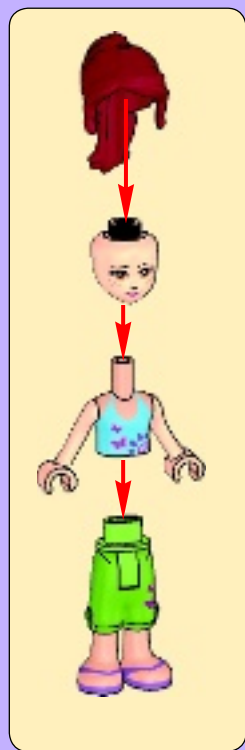

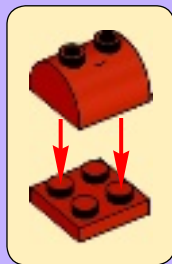

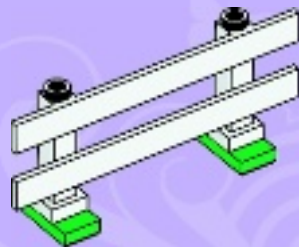
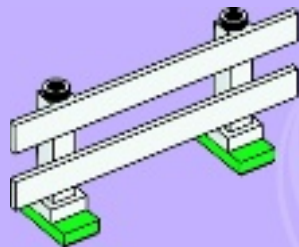
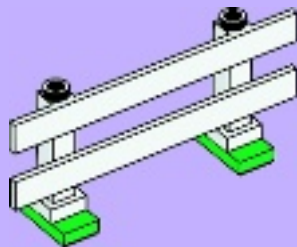
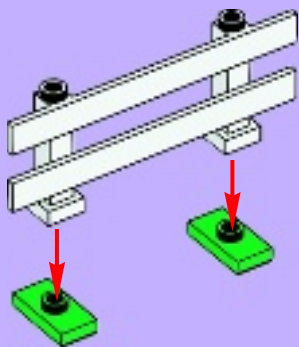
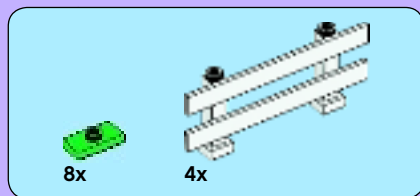



1

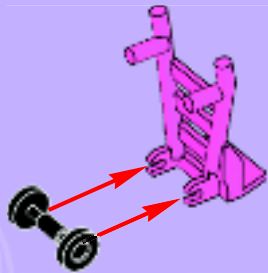

2



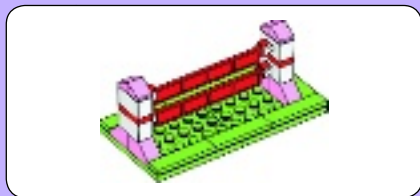

1

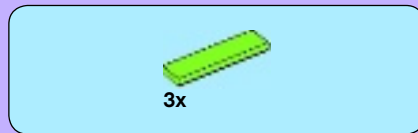
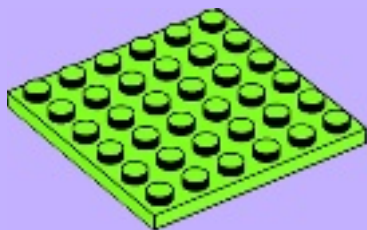

2



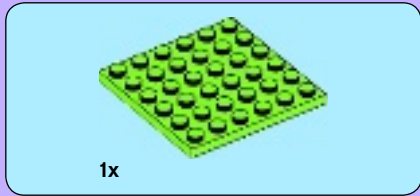

3

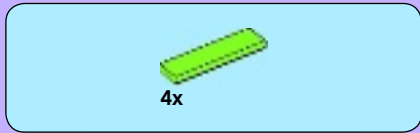
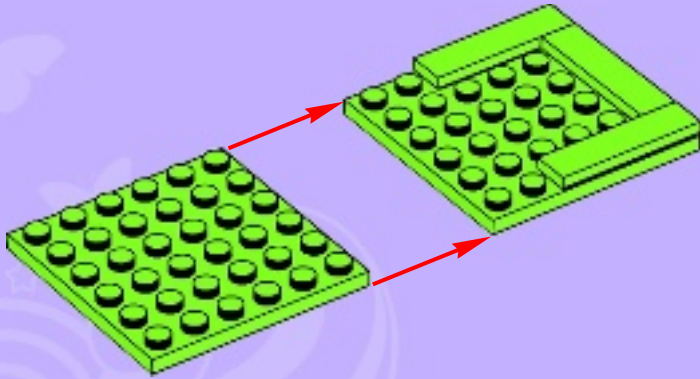

4

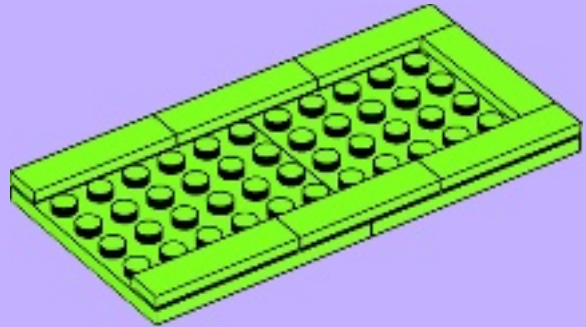



4x

5

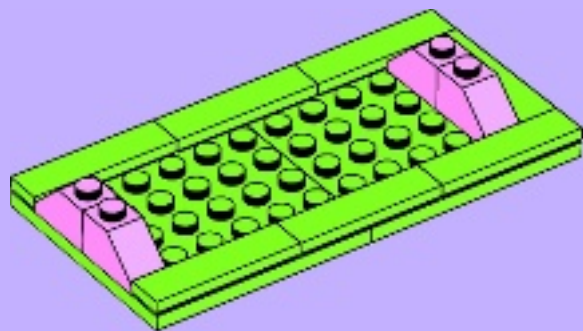

2x

6

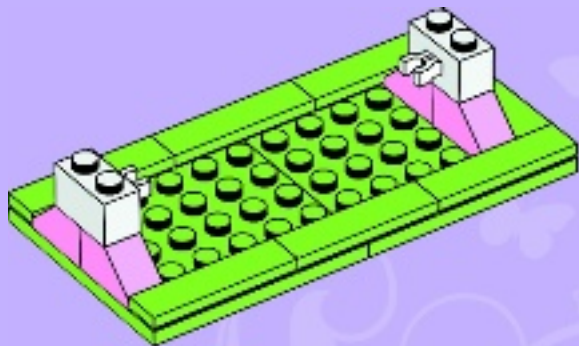



2x

7

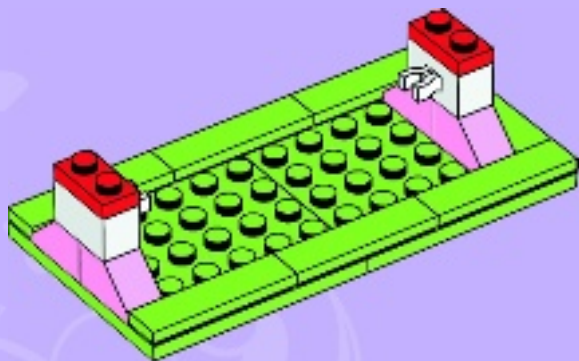

2x

8

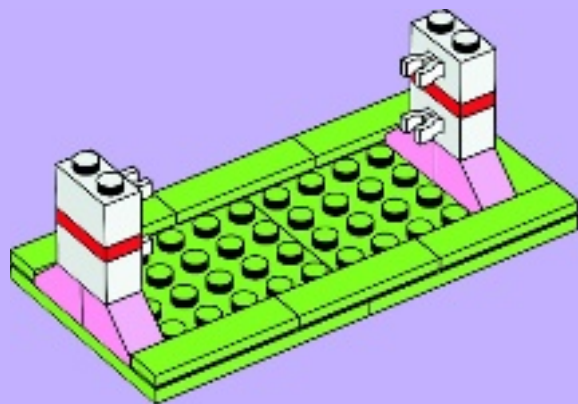



4x

9

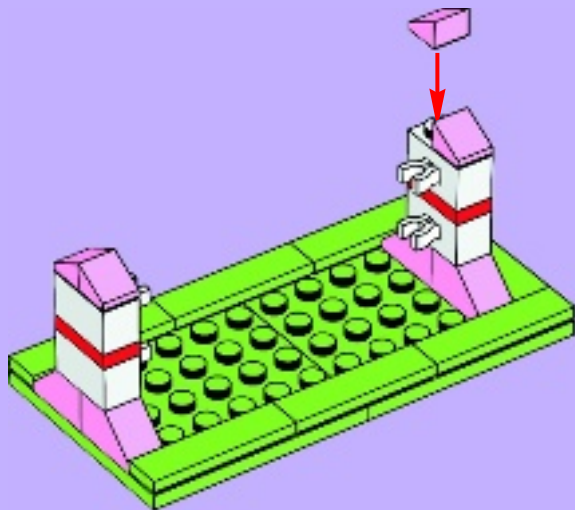

2x

10

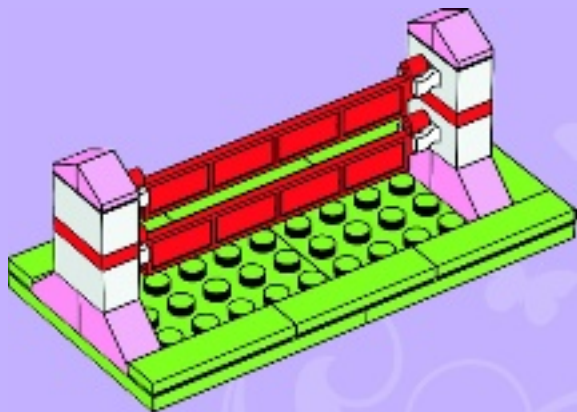



1

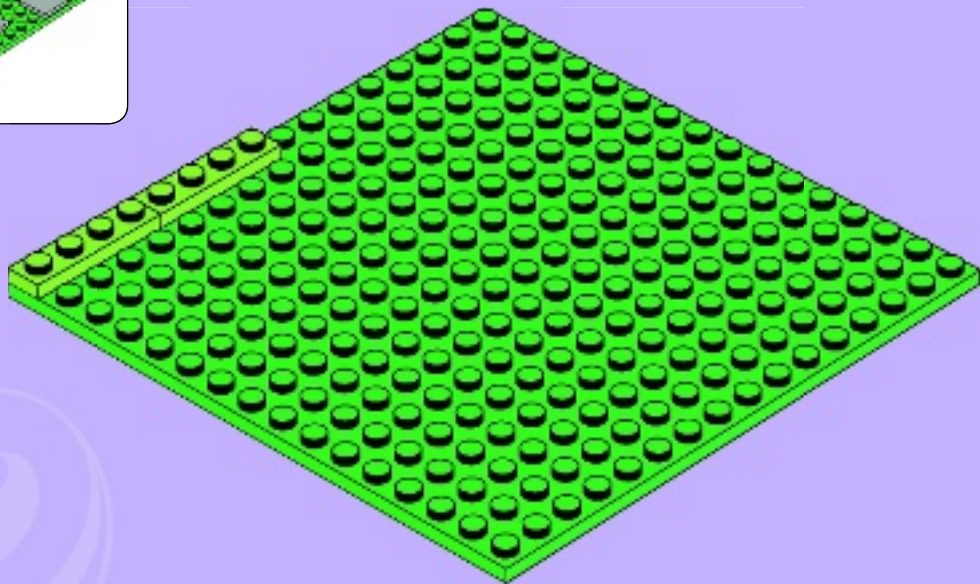



1x



1x



1x

2





1x



3x

3

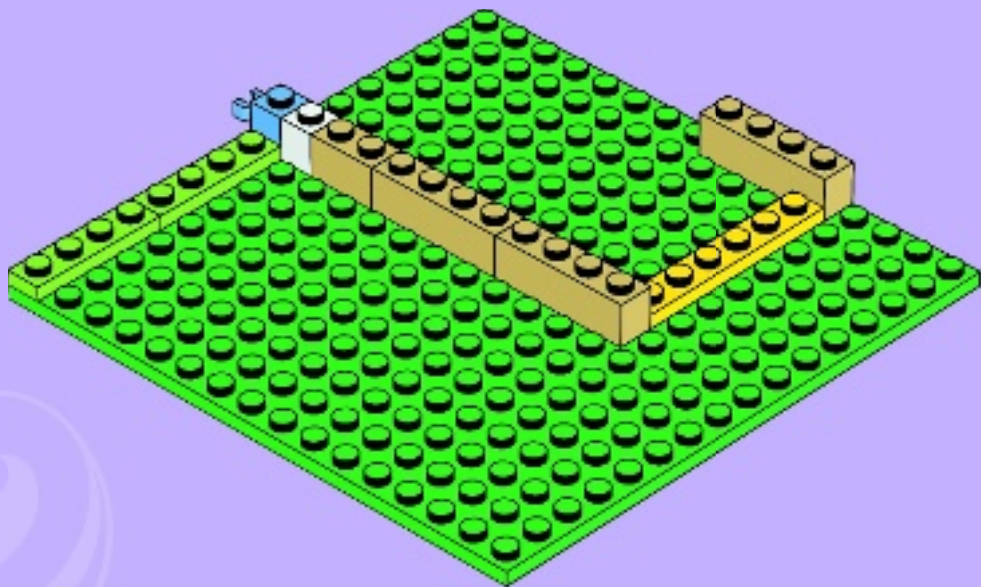



1x



3x



2x

4





4x

5

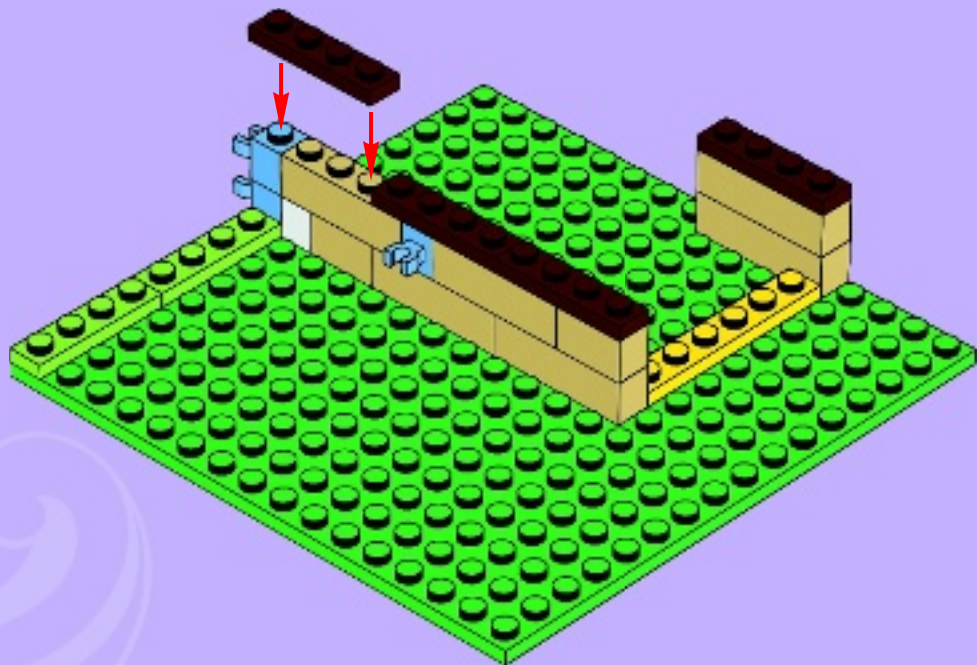

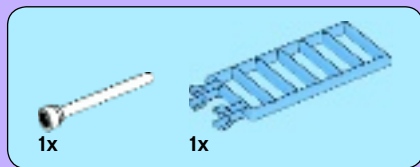

6

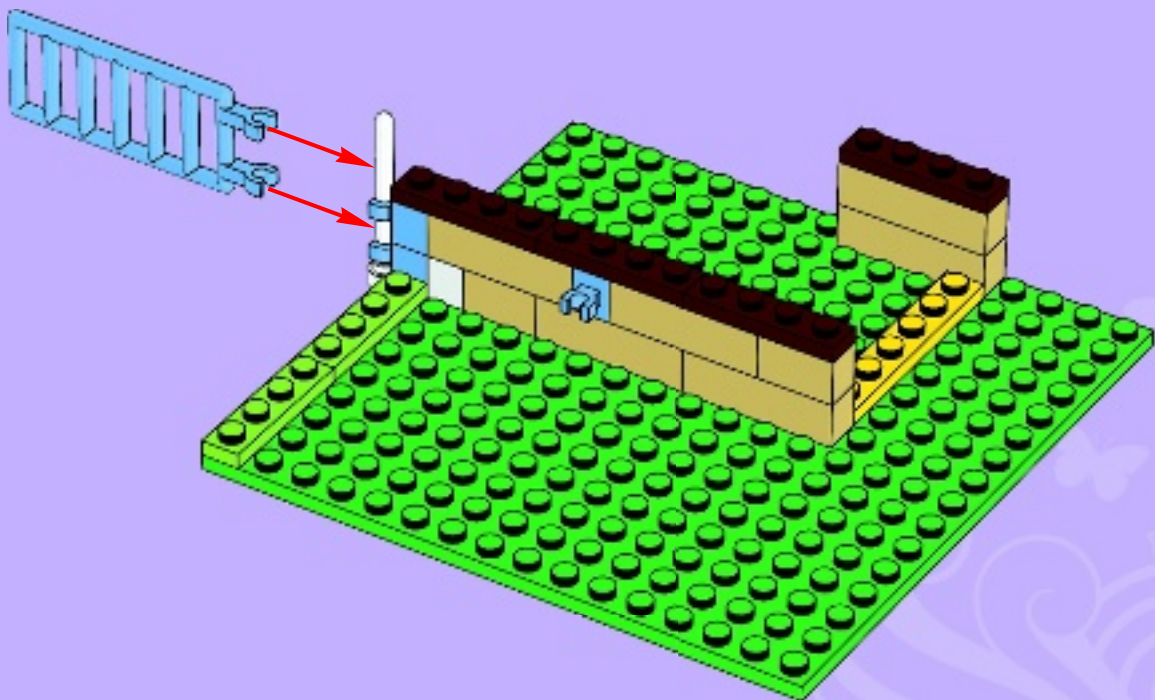

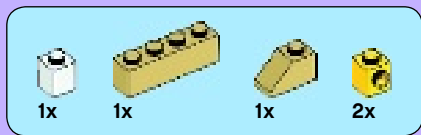

7

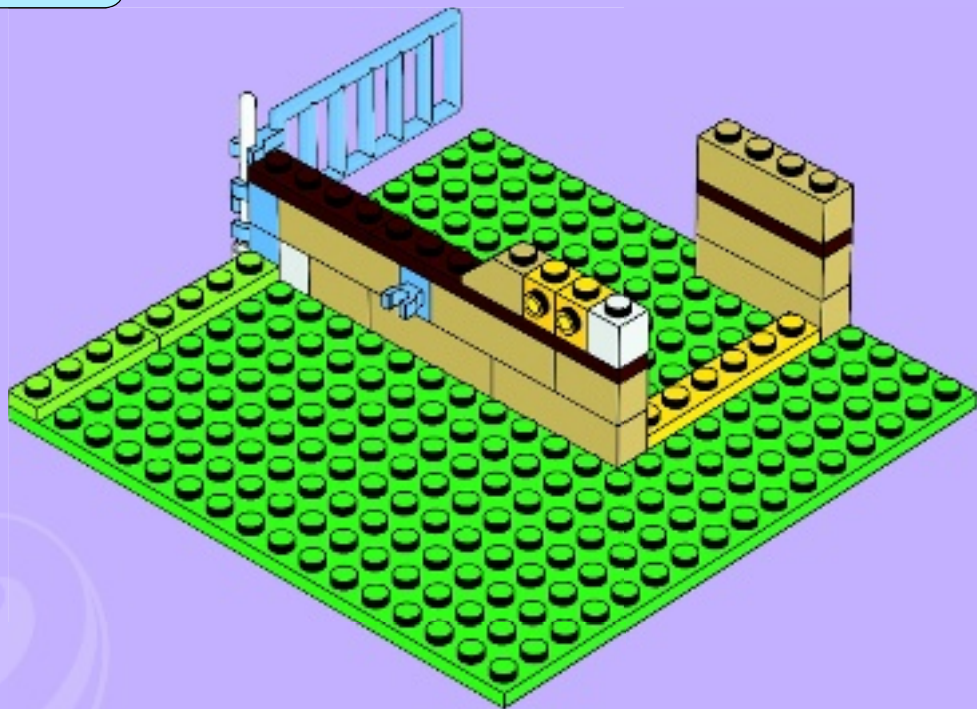



1x



1x

8

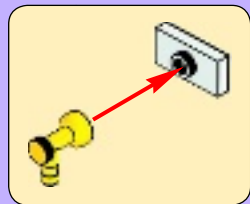



2x



2x

9

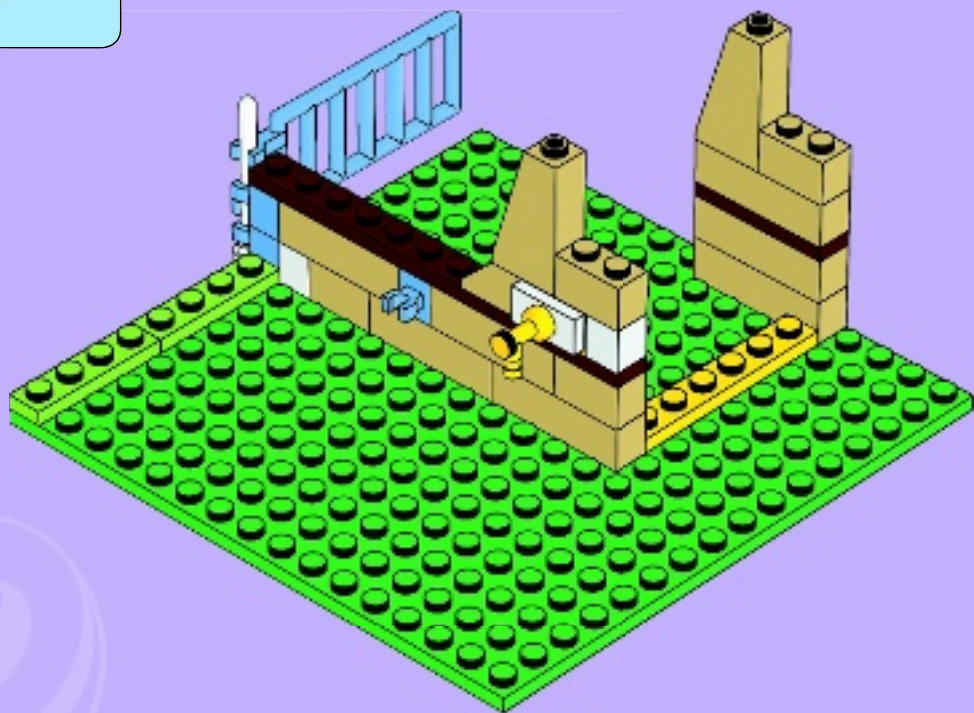

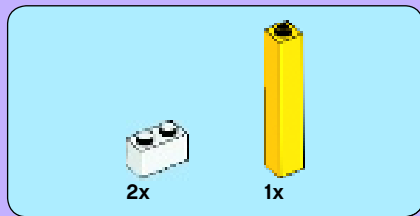

10





2x



1x

11



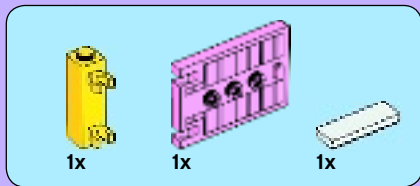

12

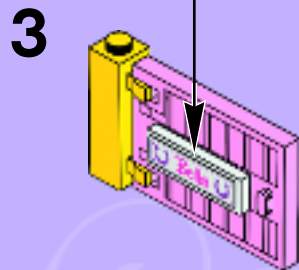
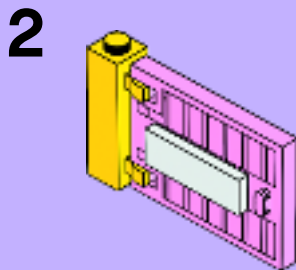
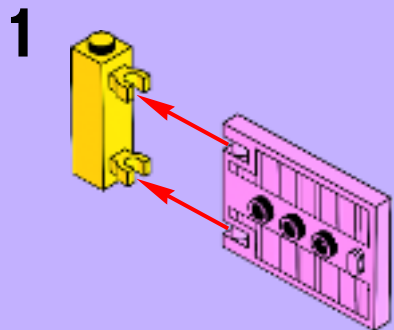







2x



2x

14





1x

15



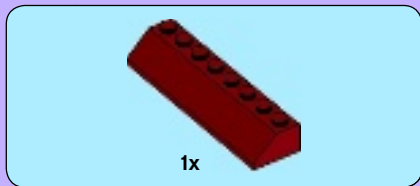

16





1x



3x

17



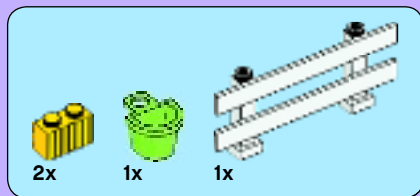

18

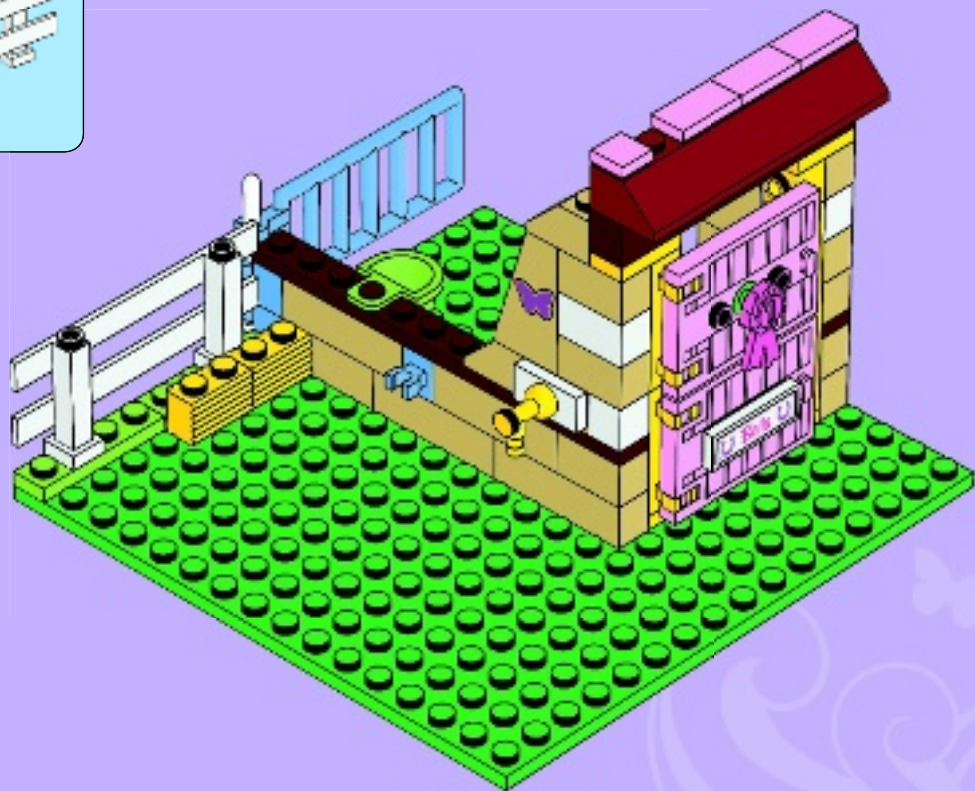



2x



1x

19

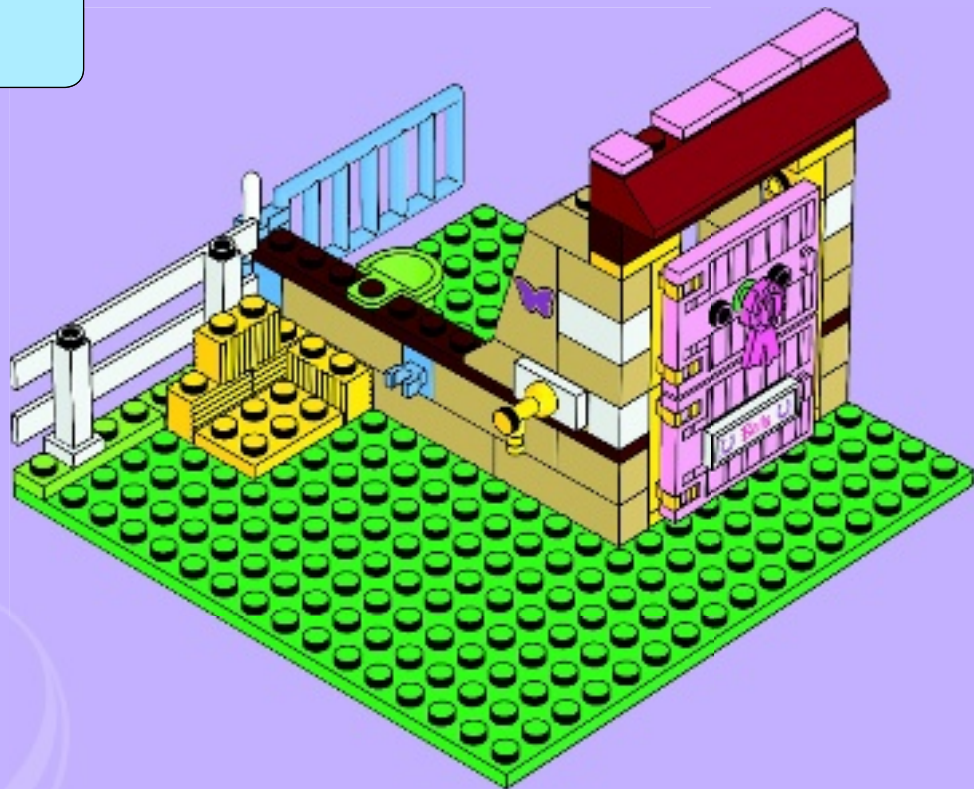



2x



4x

20





4x

21

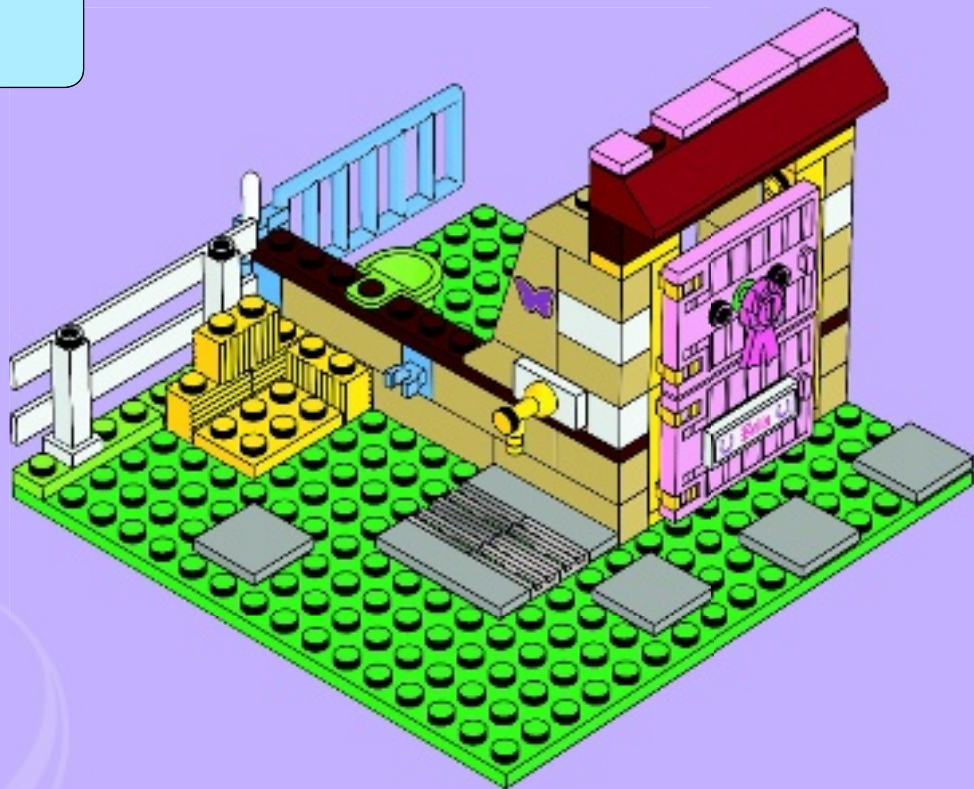

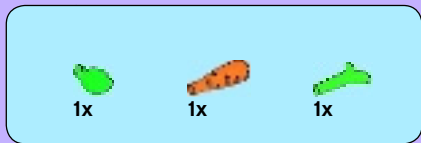

22

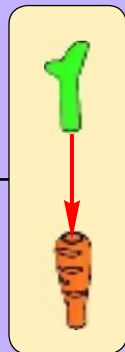



23



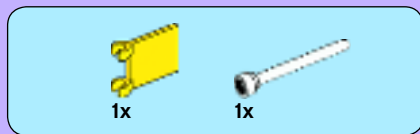

24

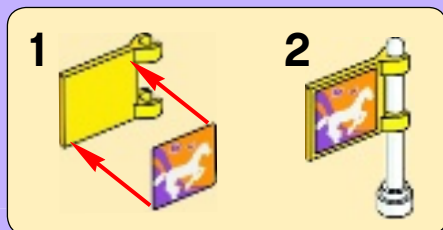



1x

25





1x



1x

26

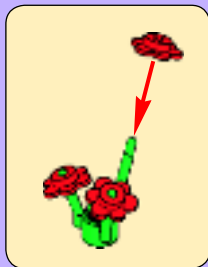

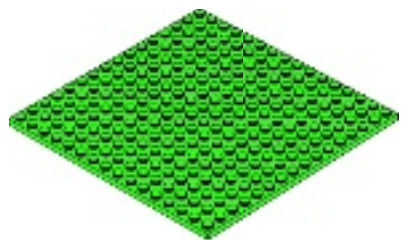

+



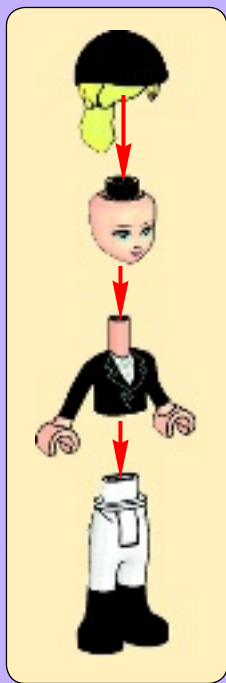

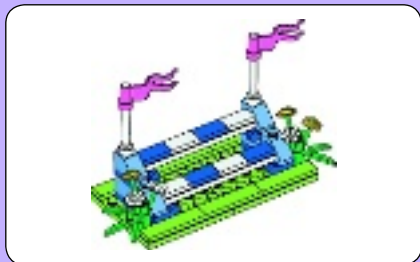

1

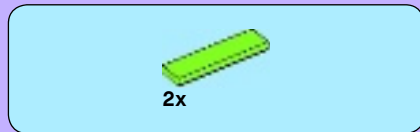

2



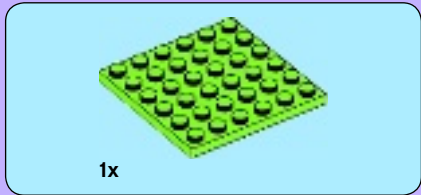

3

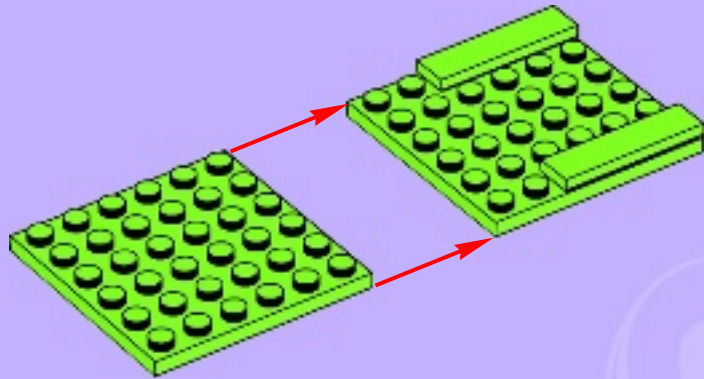



4x

4

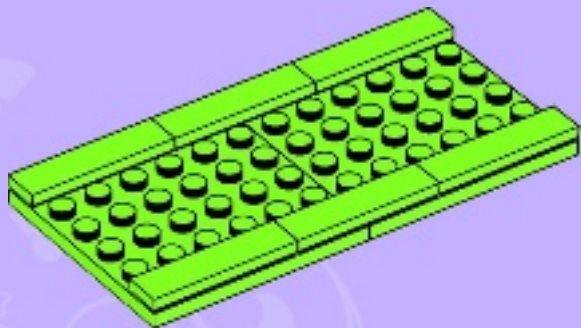

2x



2x

5

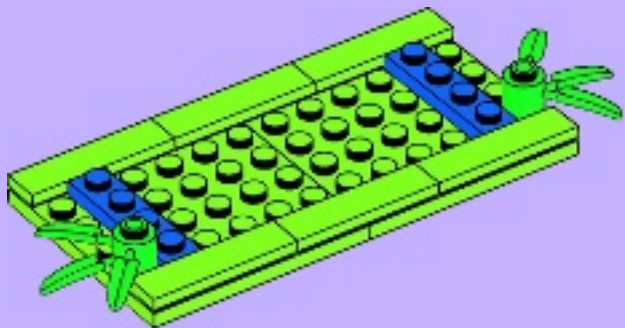



2x

6

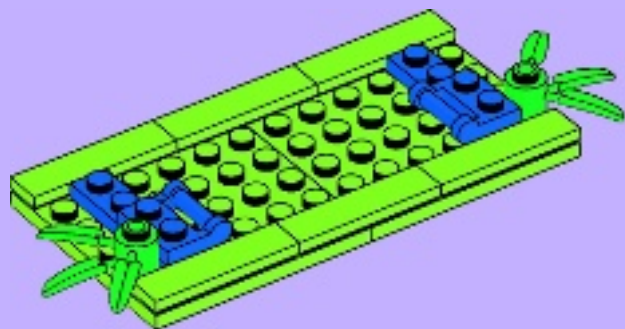

2x

7

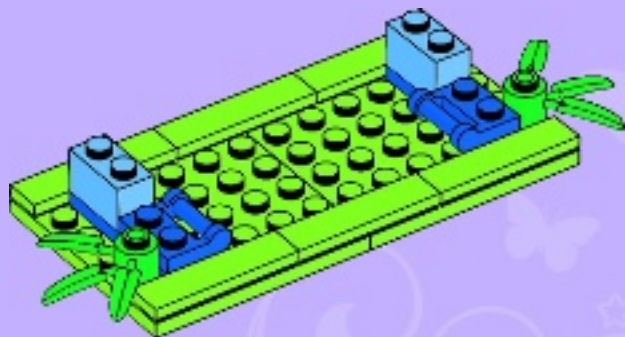



2x



2x

8

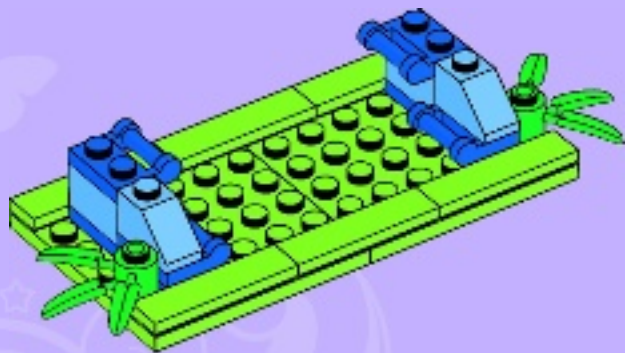

2x

9

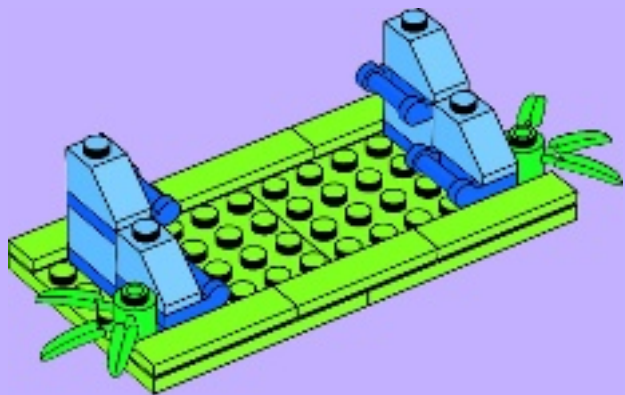

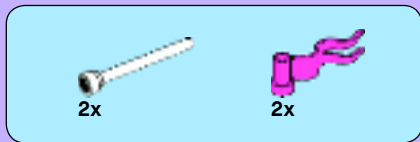

10

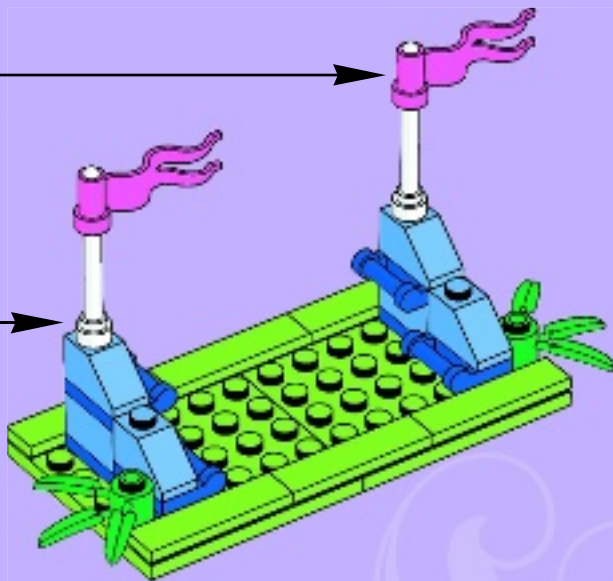
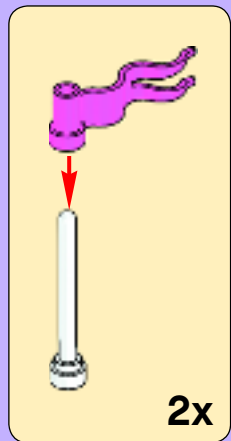

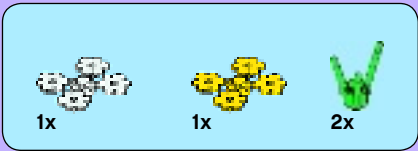

11

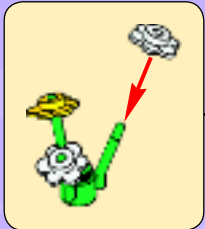
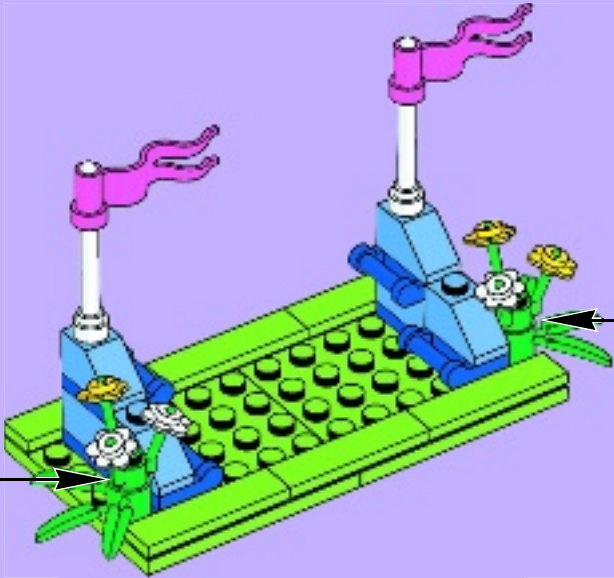

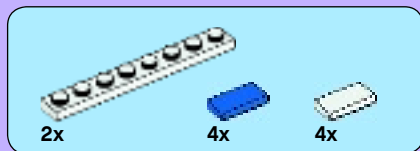

12

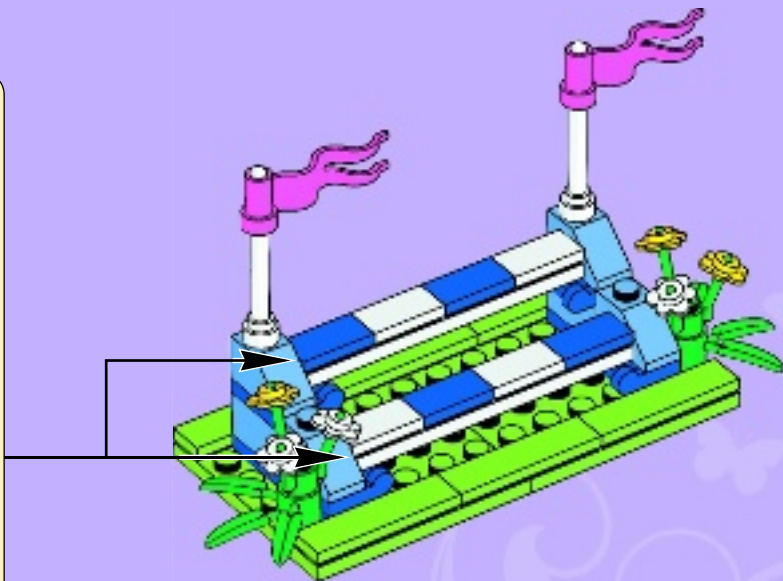
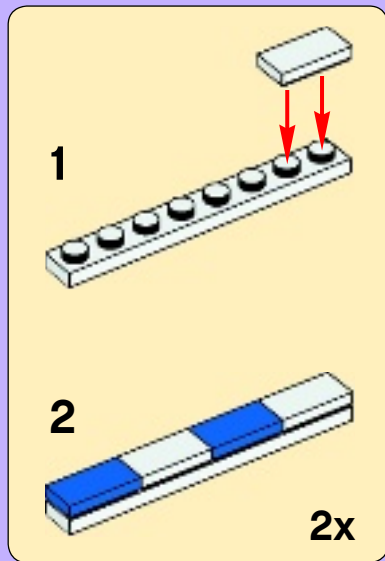



1

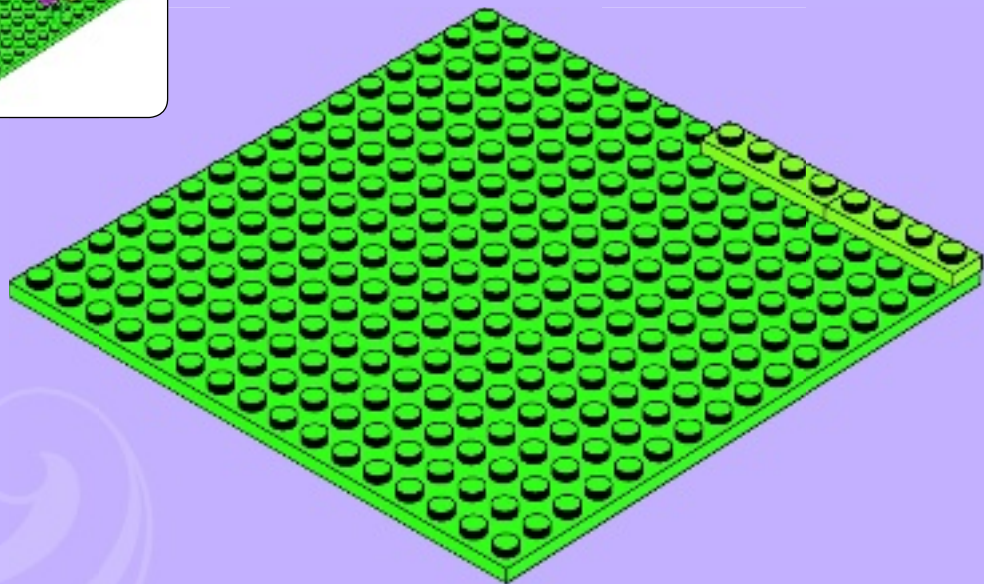



1x



1x



1x

2

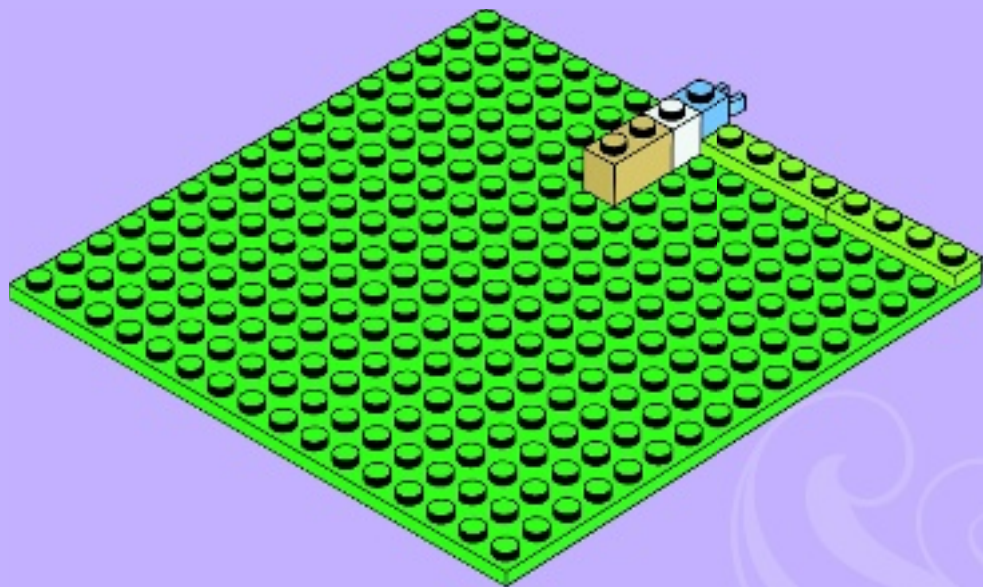



1x



3x

3

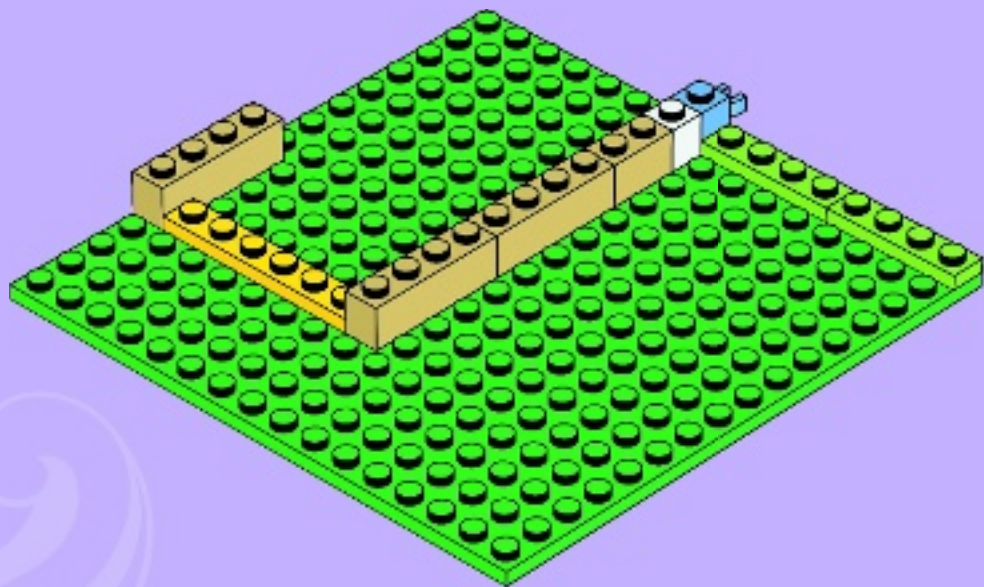

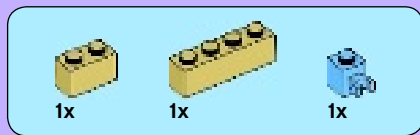

4

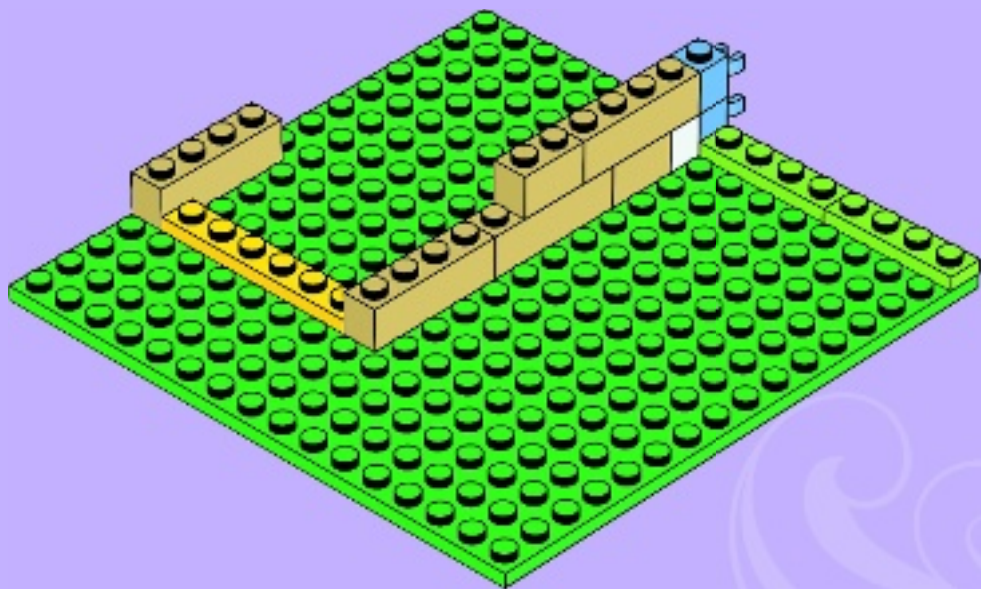



2x



1x

5

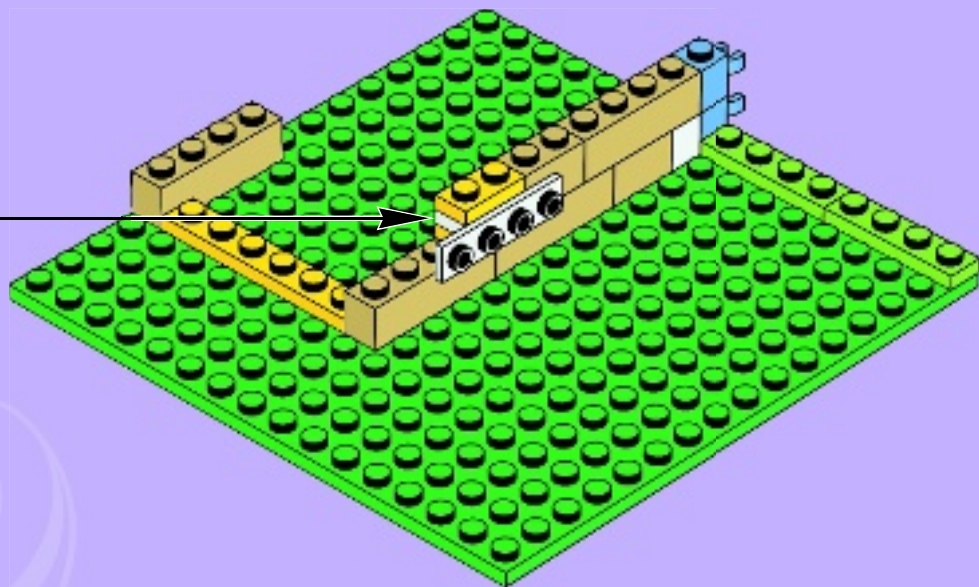
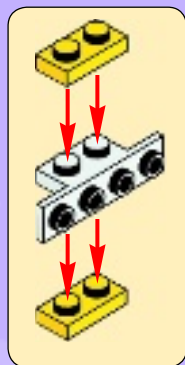



6





4x

7

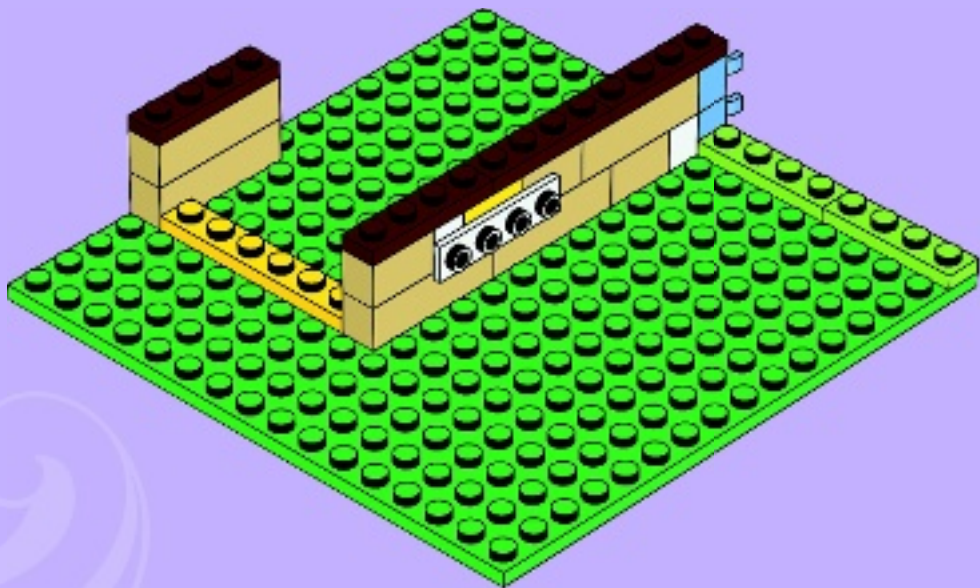

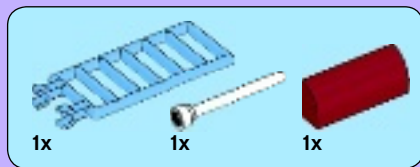

8

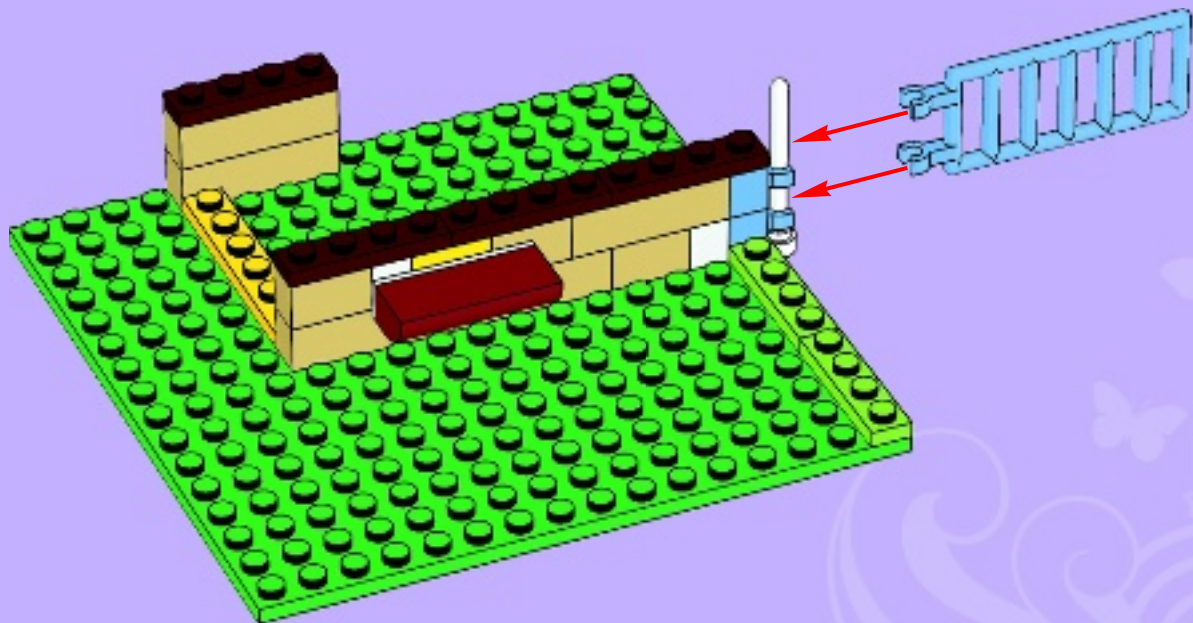

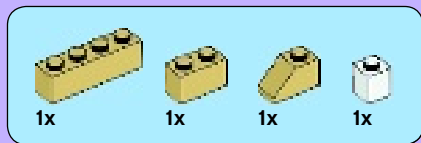

9

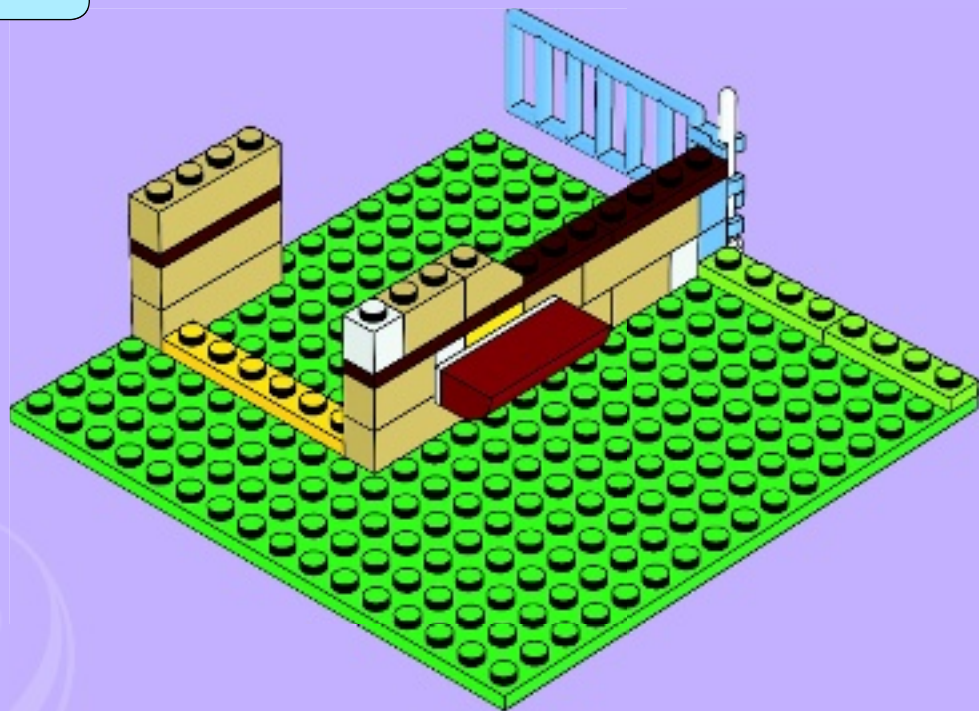



2x



2x

10



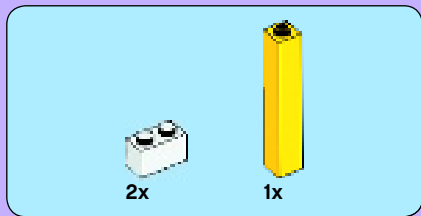

11

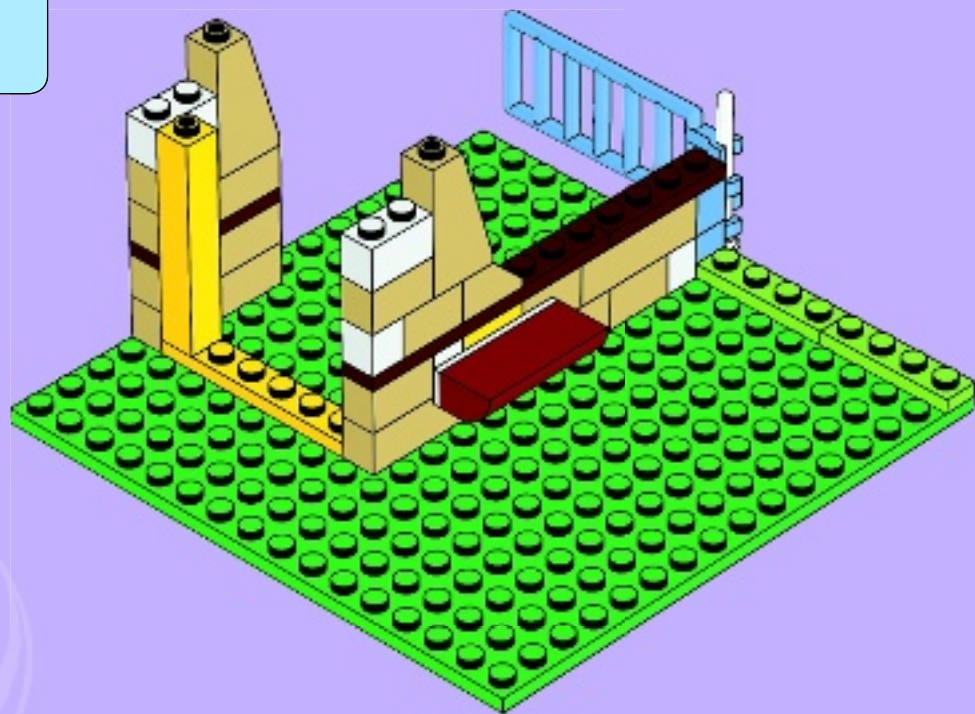



2x



1x

12



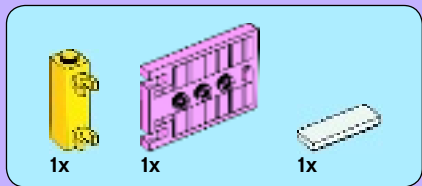

13

1

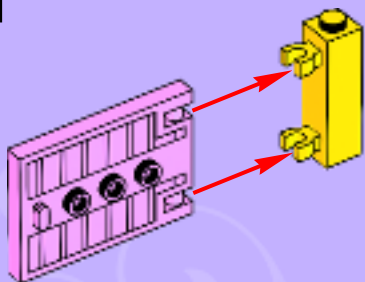

2

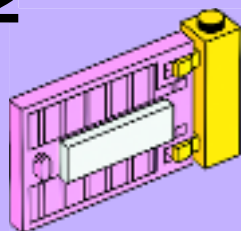

3

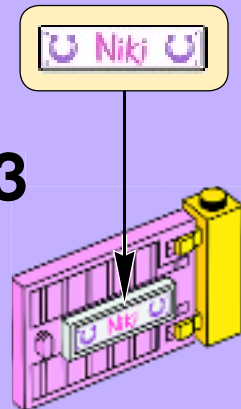



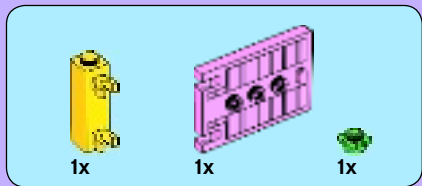

14

1

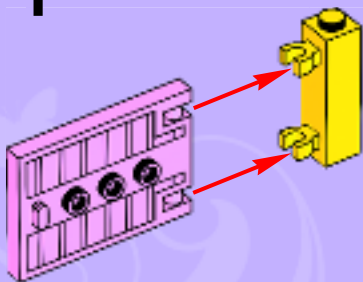

2

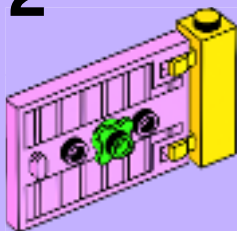

3

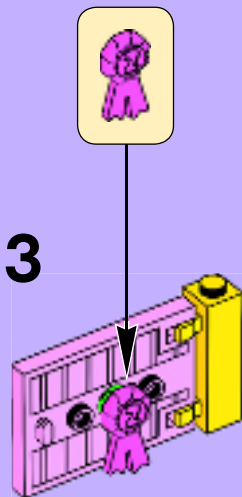





2x



2x

15

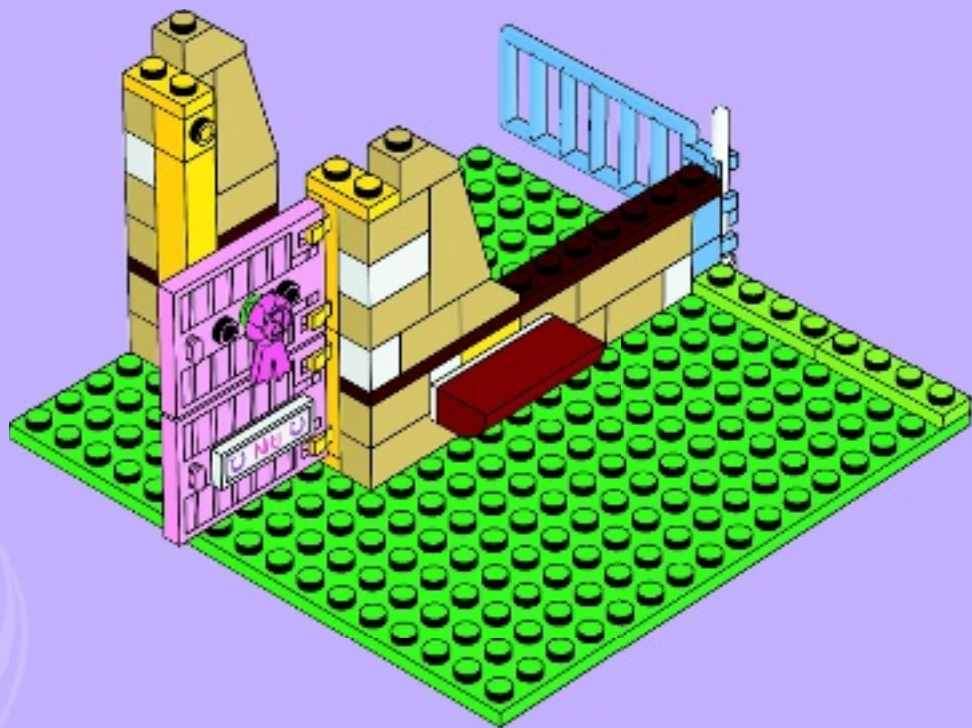



1x

16



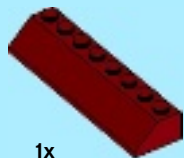

1x

17

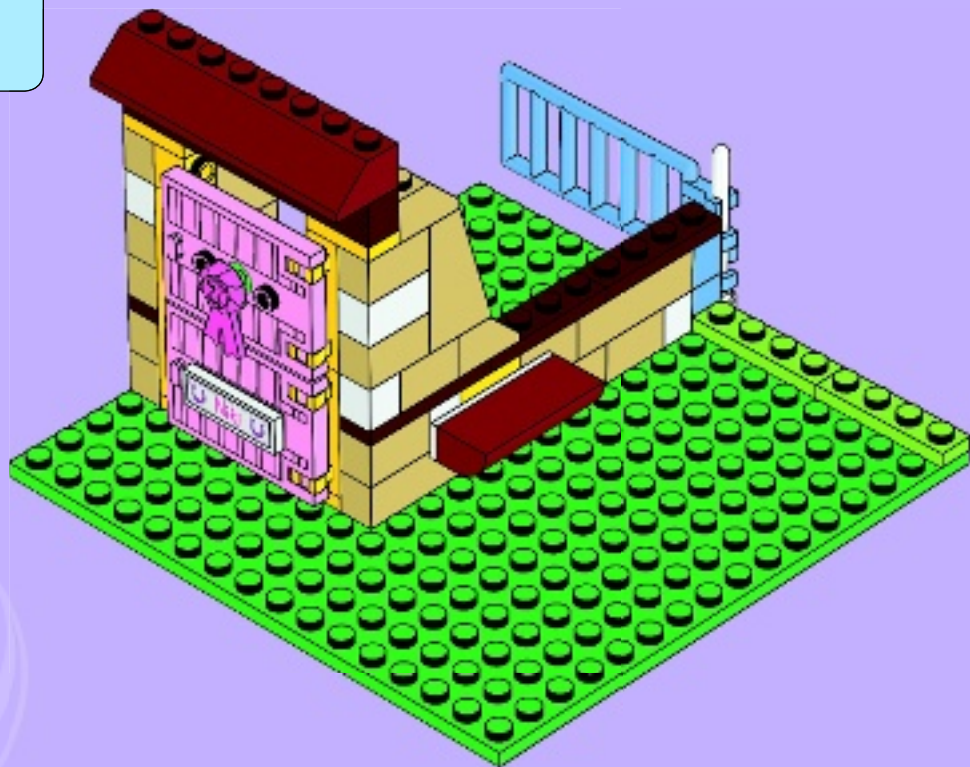



1x



3x

18



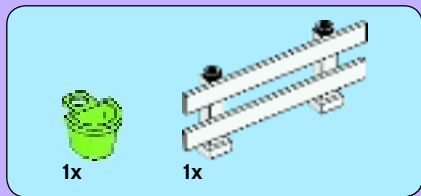

19

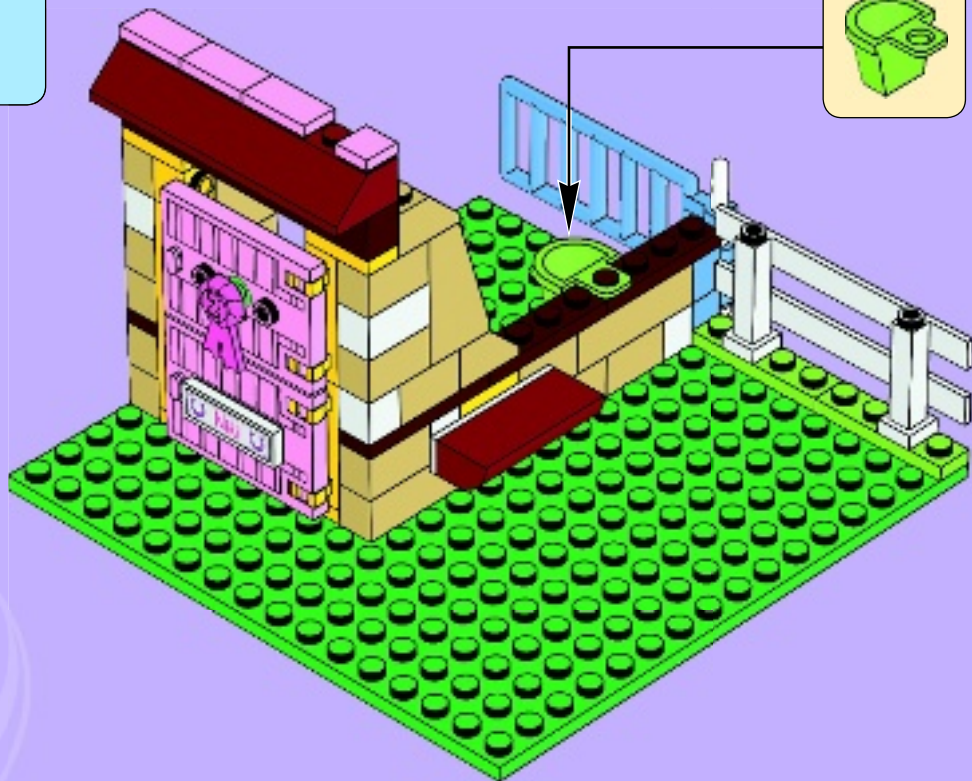

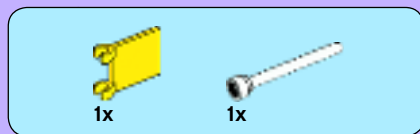

20

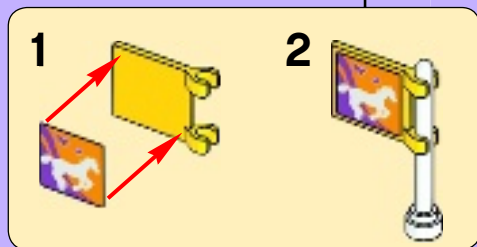



1x

21





2x



4x

22





4x

23





8x

24

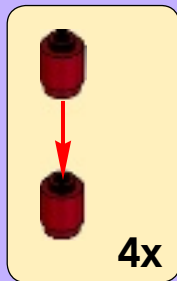



2x

25



1x

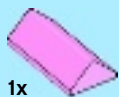

26



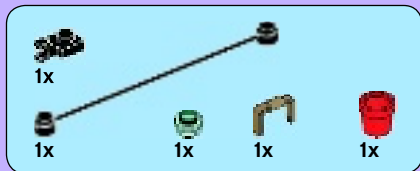

27

1



2



3



4



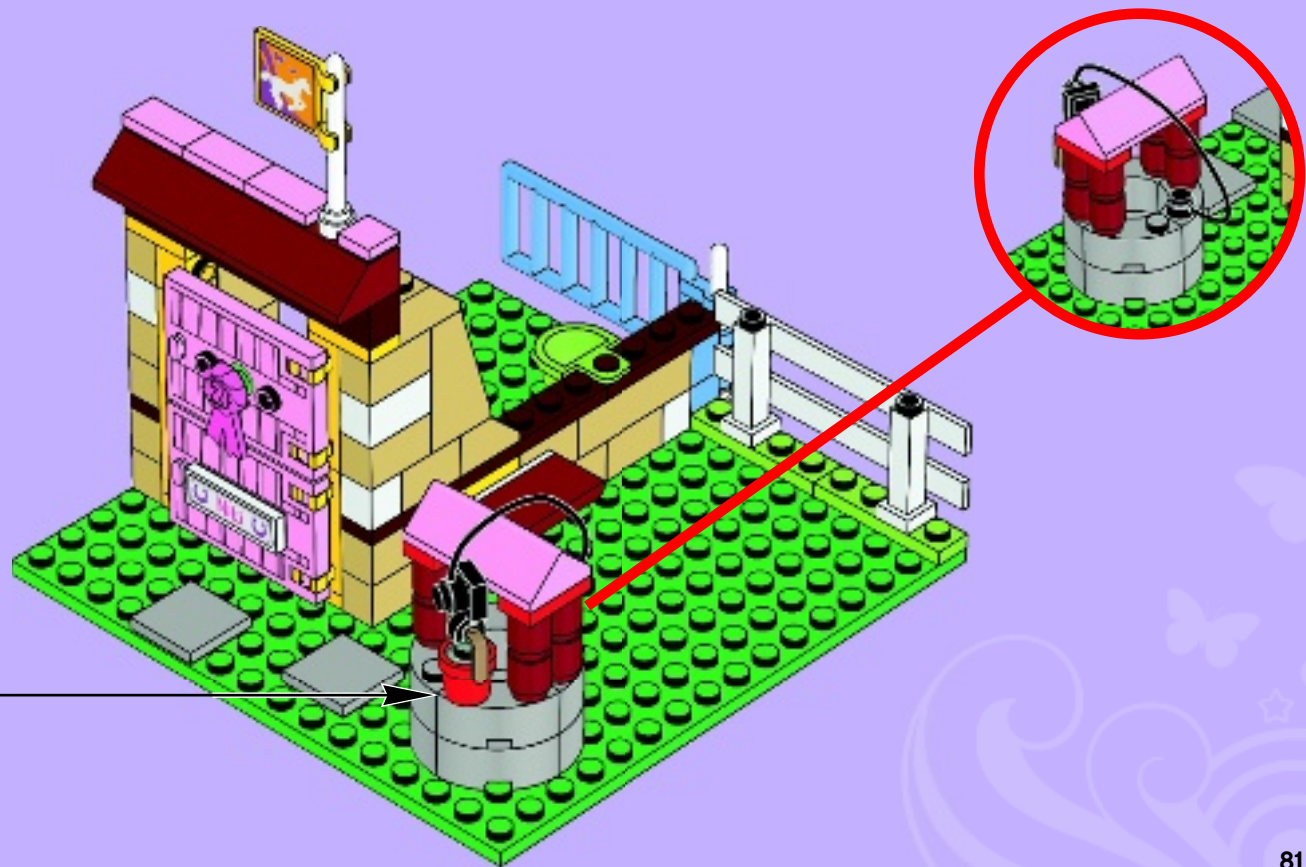

2x 1x 1x

28

2x

1x



1x  1x  2x 

29





Win!

Go to www.LEGOsurvey.com/product to fill out a survey for a chance to win a cool LEGO® Product.
No purchase necessary.
Open to all residents where not prohibited.



www.LEGOsurvey.com/product

Gewinne! Win!

Nimm an der Umfrage auf www.LEGOsurvey.com/product teil und hab die Chance ein cooles LEGO® Produkt zu gewinnen!

Die Teilnahme am Gewinnspiel führt zu keinerlei Kaufverpflichtungen. Teilnahme in allen nicht ausgeschlossenen Ländern möglich.

LEGO and the LEGO logo are trademarks of the/son des marques de commerce de/son marcas registradas de LEGO Group. ©2012 The LEGO Group.

Ga naar www.LEGOsurvey.com/product, vul een enquêteformulier in en maak kans op een cool LEGO® product.

Geen aankoopverplichting. Iedereen mag deelnemen, uitgezonderd ingezetenden van landen waar een enquêteverbod geldt.

Gagne! 当てよう!

Visite www.LEGOsurvey.com/product pour répondre à un questionnaire et avoir une chance de gagner un produit LEGO® très cool!

Aucune obligation d'achat. Ouvert à tous les résidents des pays autorisés.

www.LEGOsurvey.com/product にアクセスして、アンケートにご記入ください。当選者にはレゴ® 製品を差し上げます。

お買い上げの必要はありません。

禁止されていない限り、すべての皆様にご利用いただけます。

6029680 / 6029681

