



Friends



3187

1

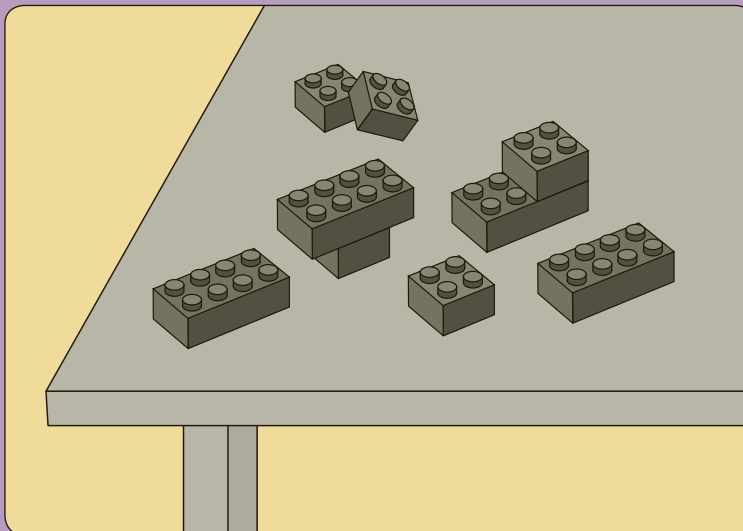
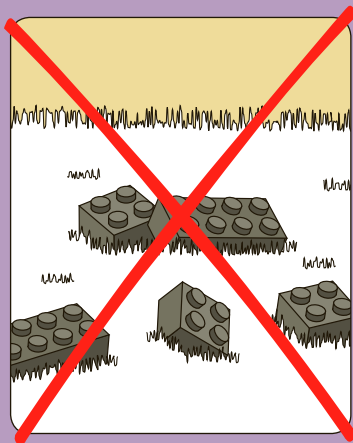

2



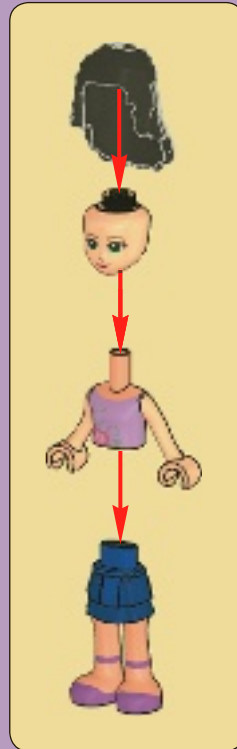
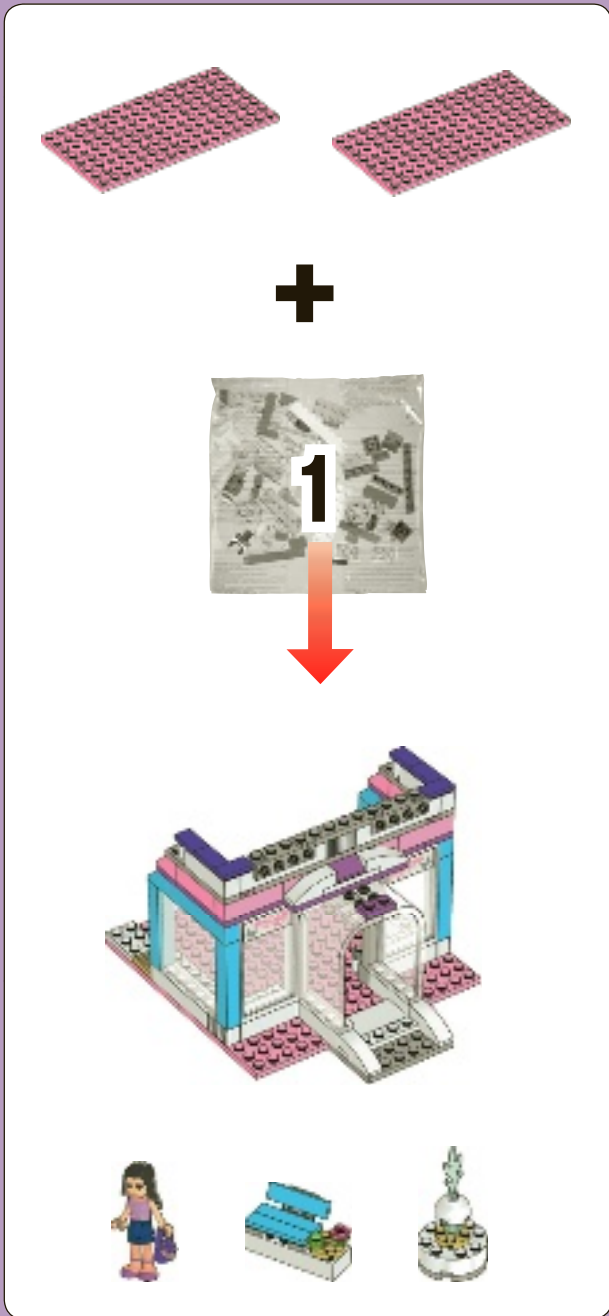

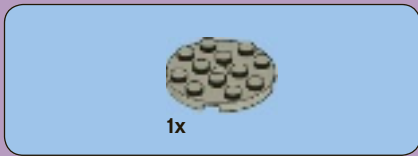

1

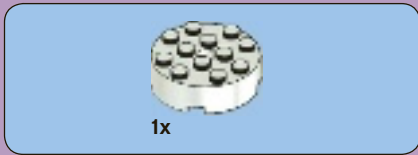

2



3

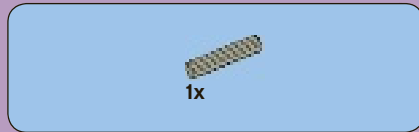

4

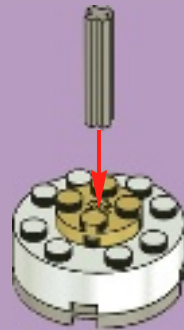



5



6



7



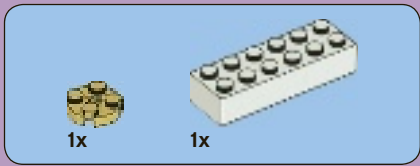

1

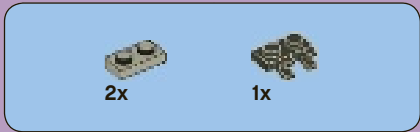

2



3

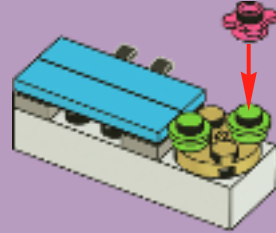

4

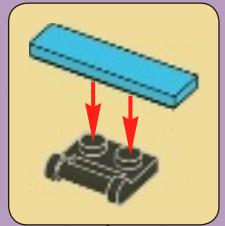

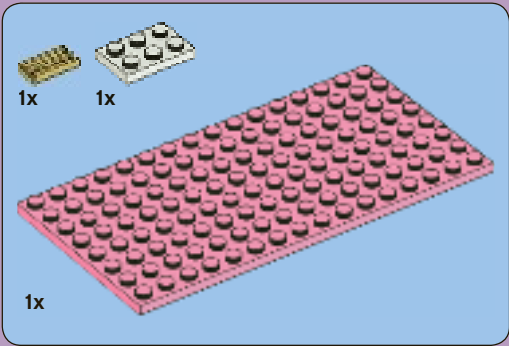

1

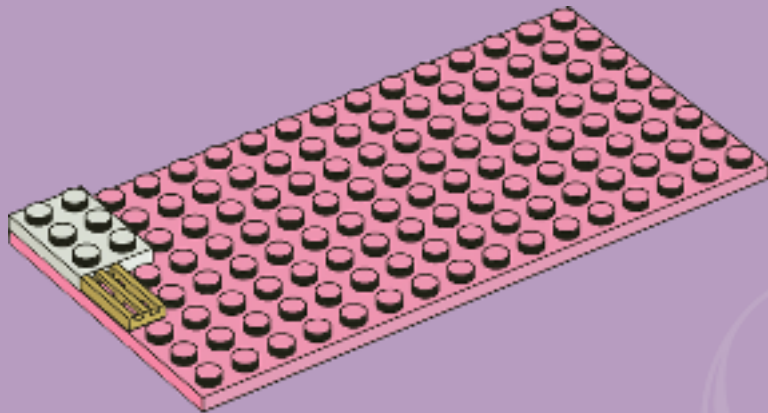

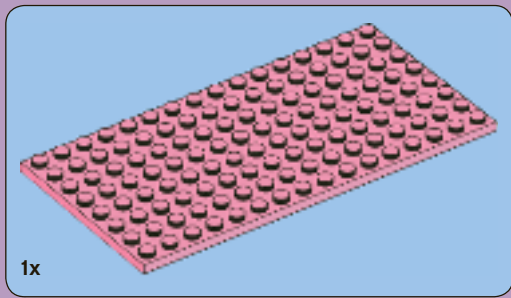

2

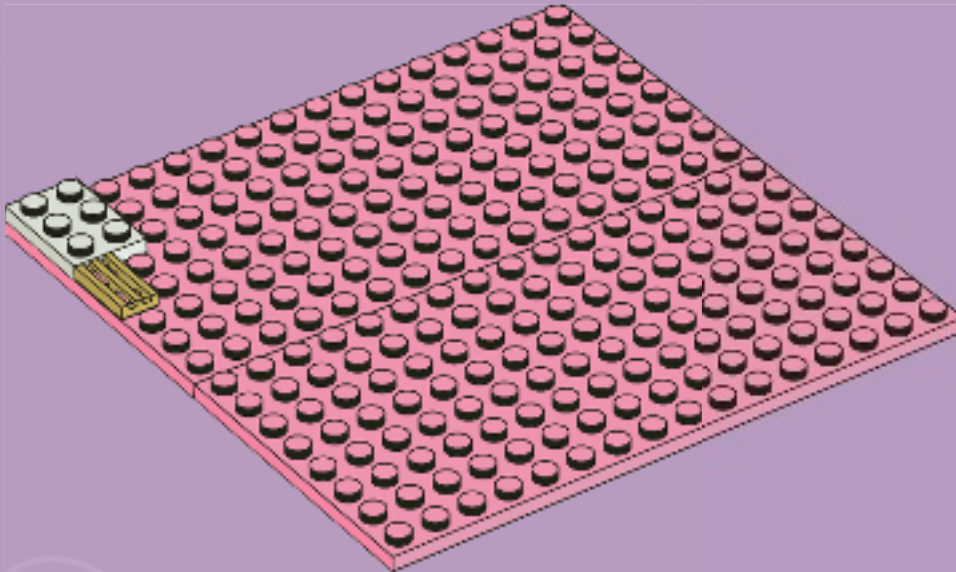

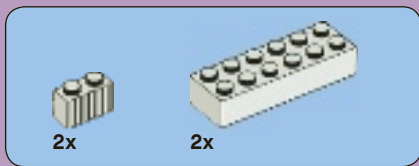

3

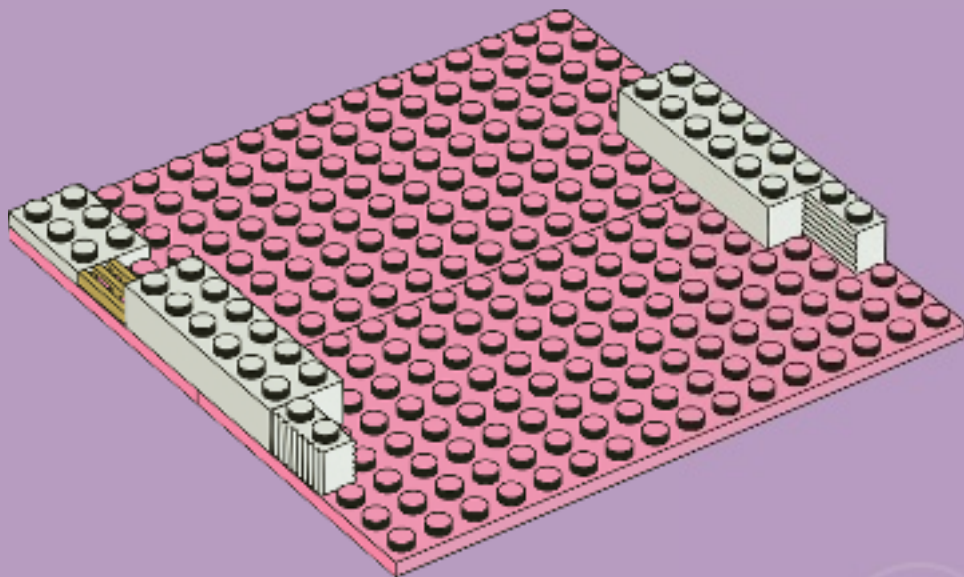



4

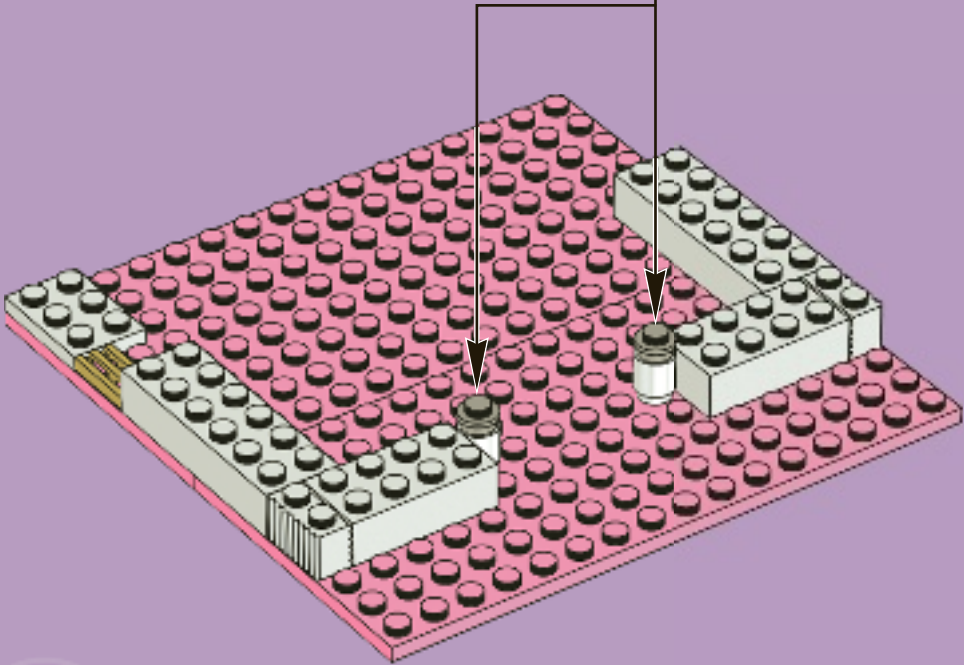
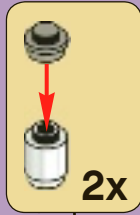

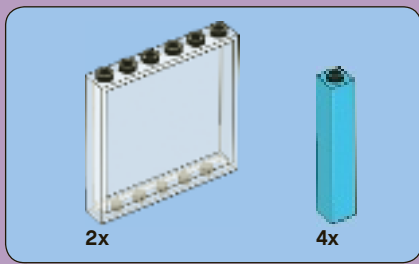

5

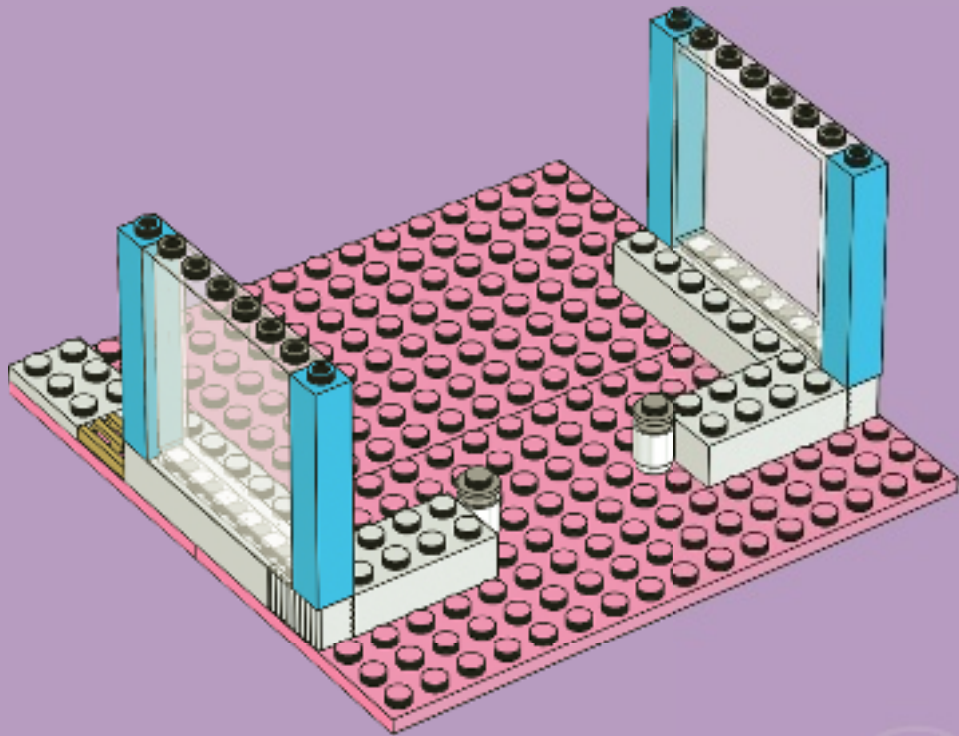

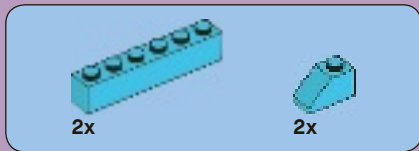

6

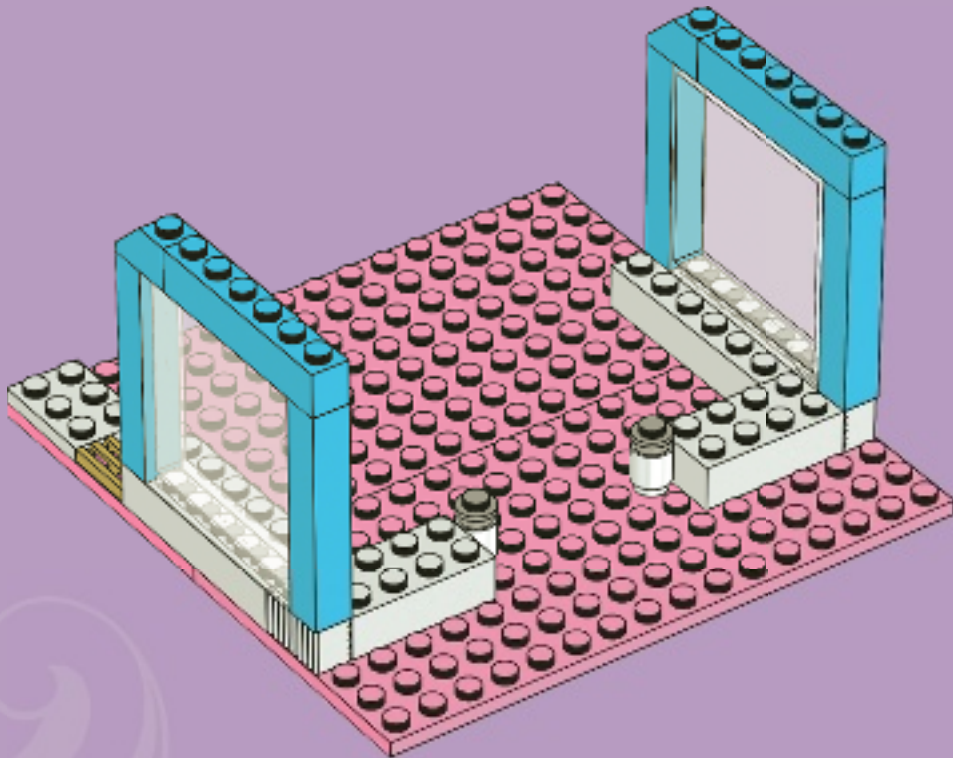

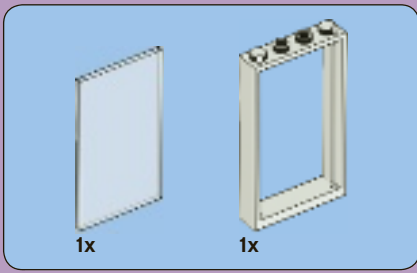

7

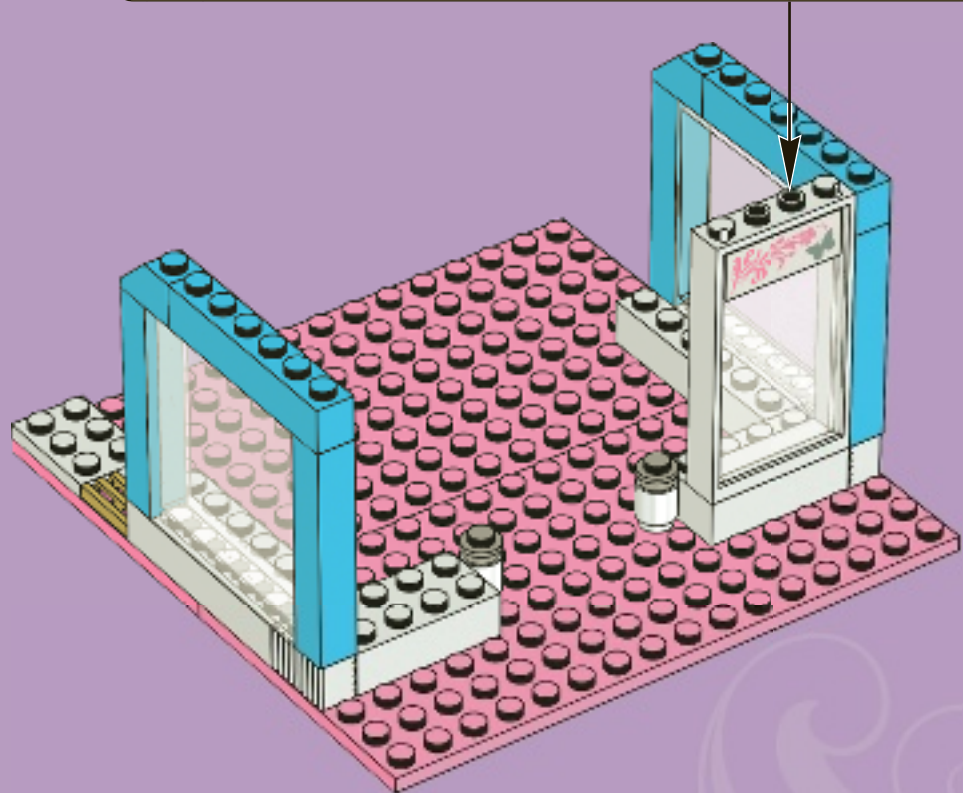
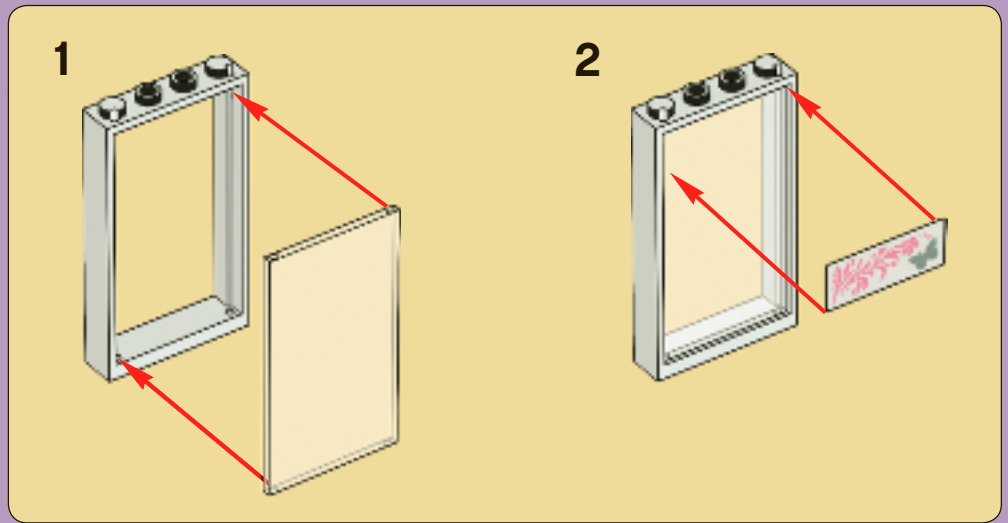

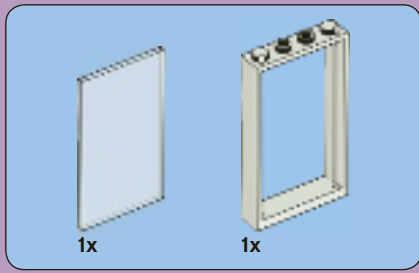

8

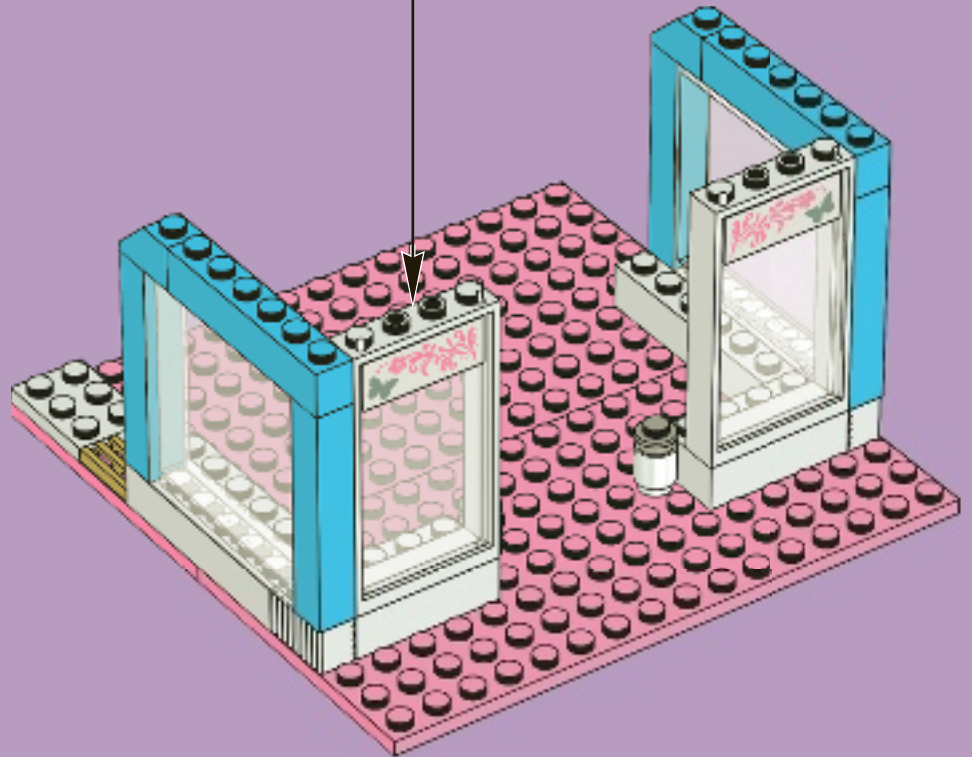
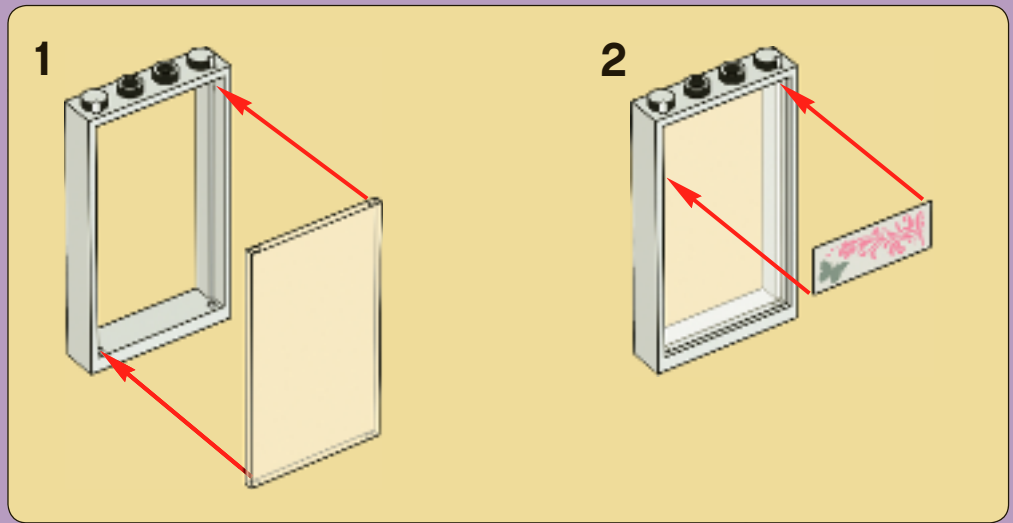

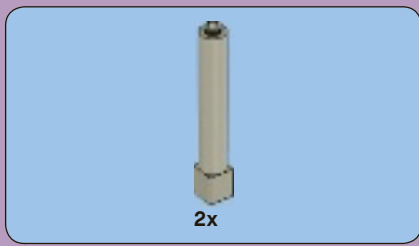

9

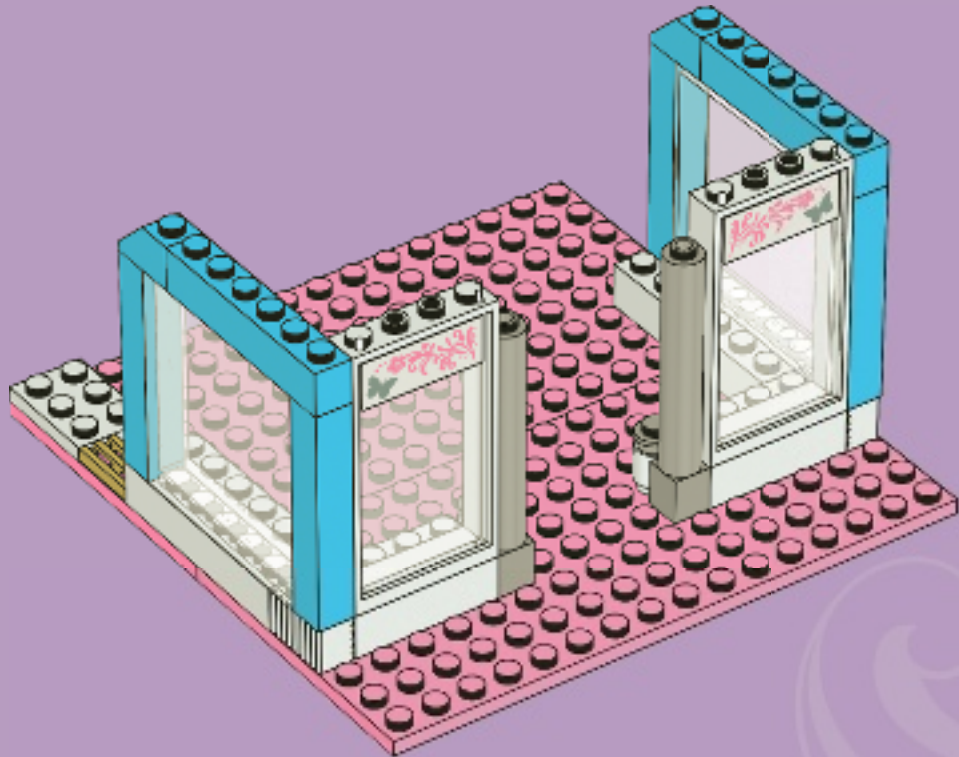

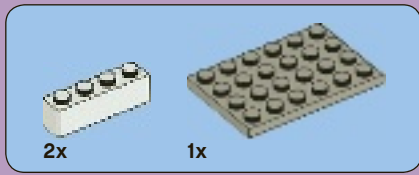

10

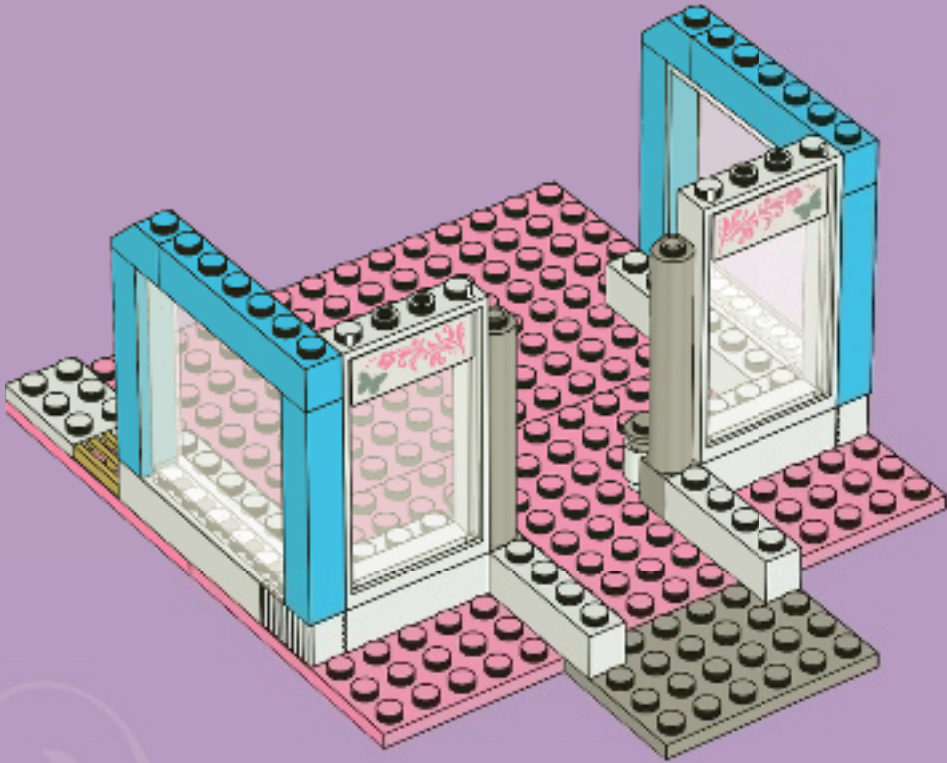

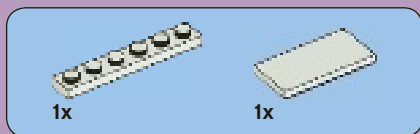

11

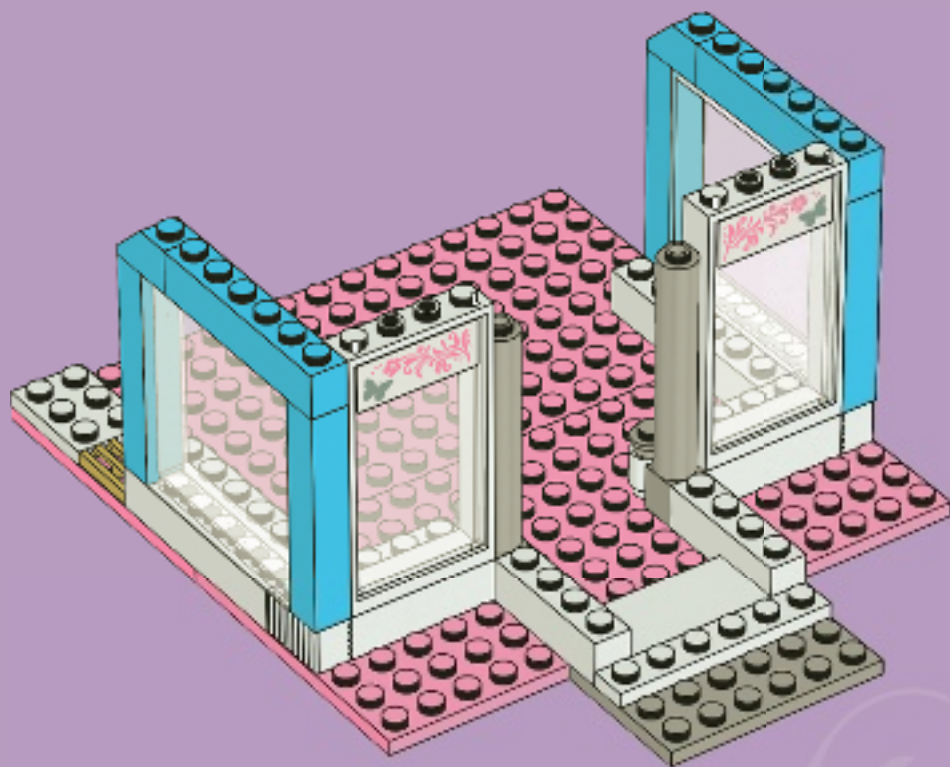

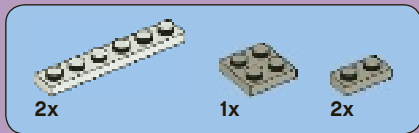

12

1

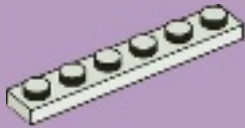

2

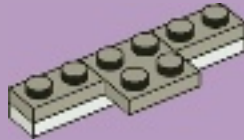

3

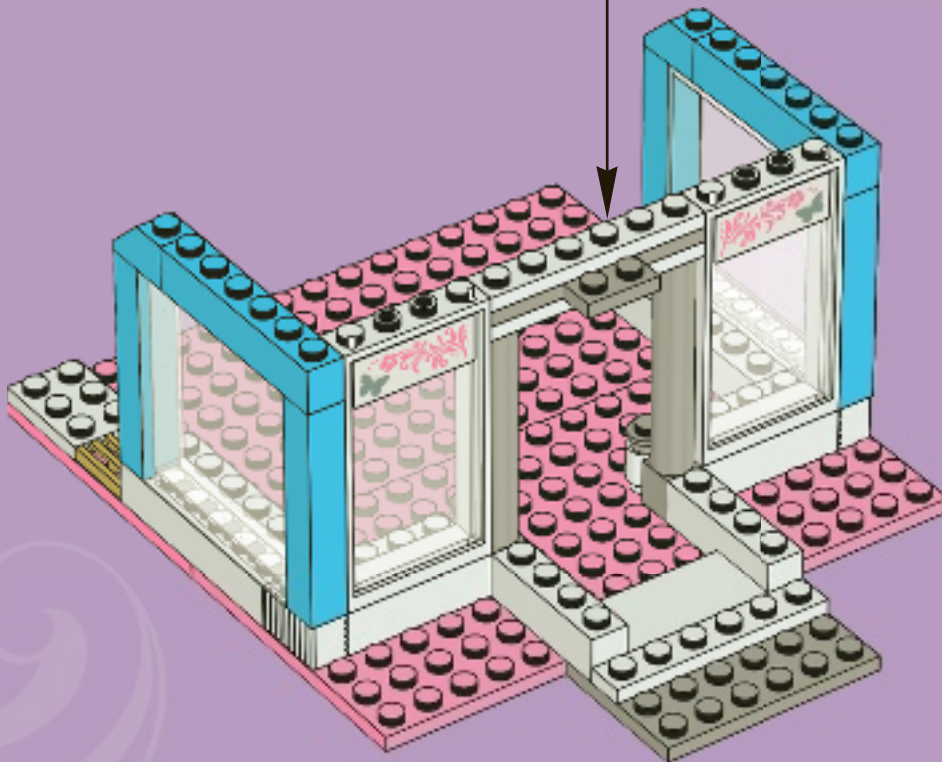
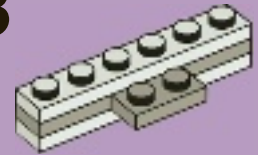

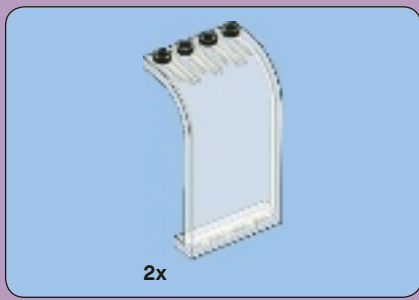

13

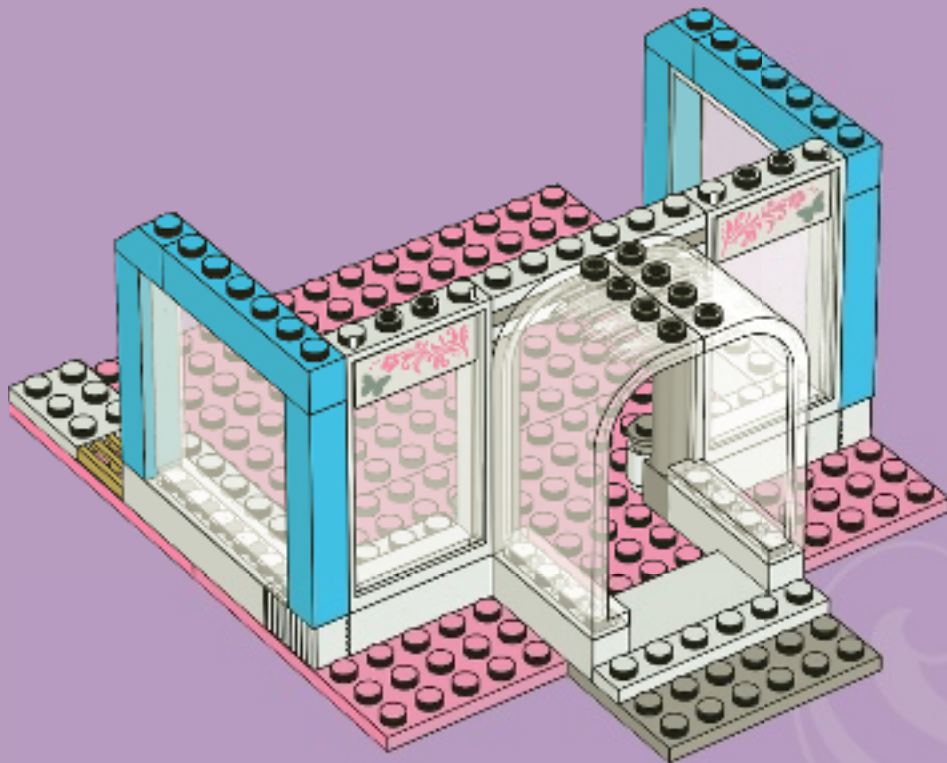



14

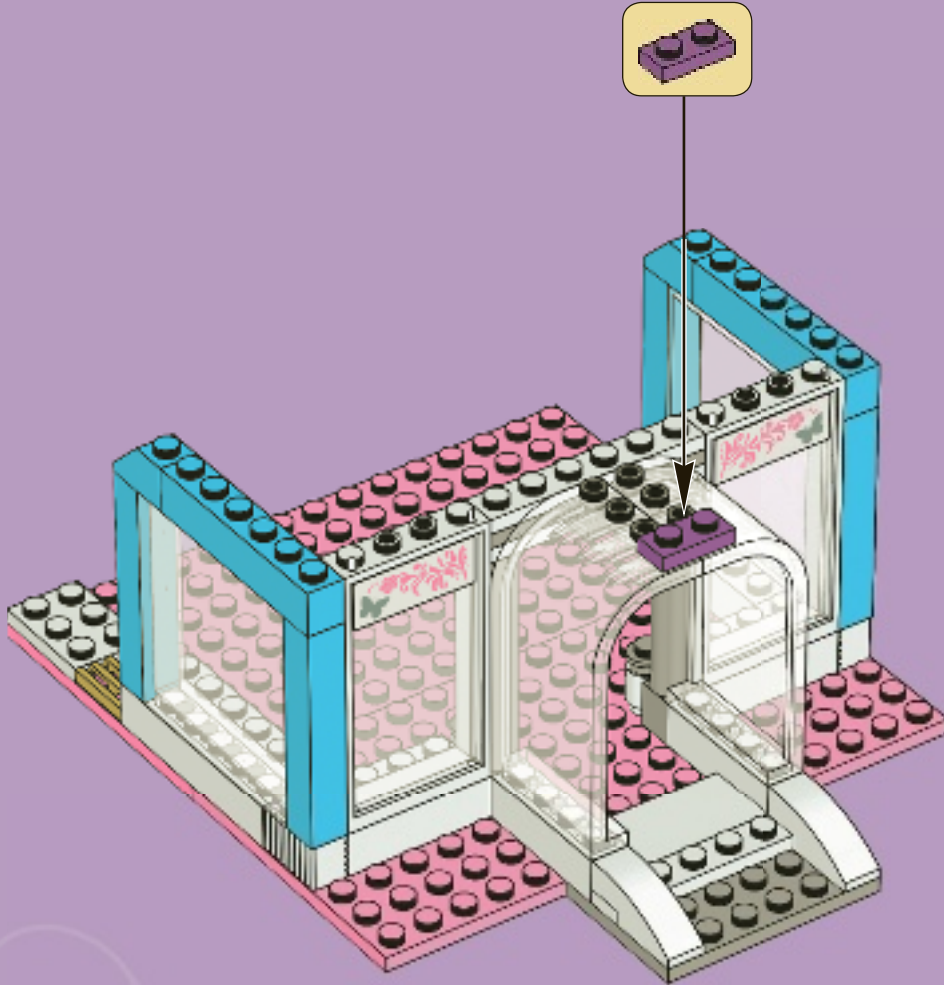

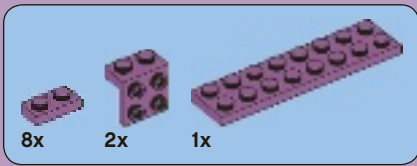

15

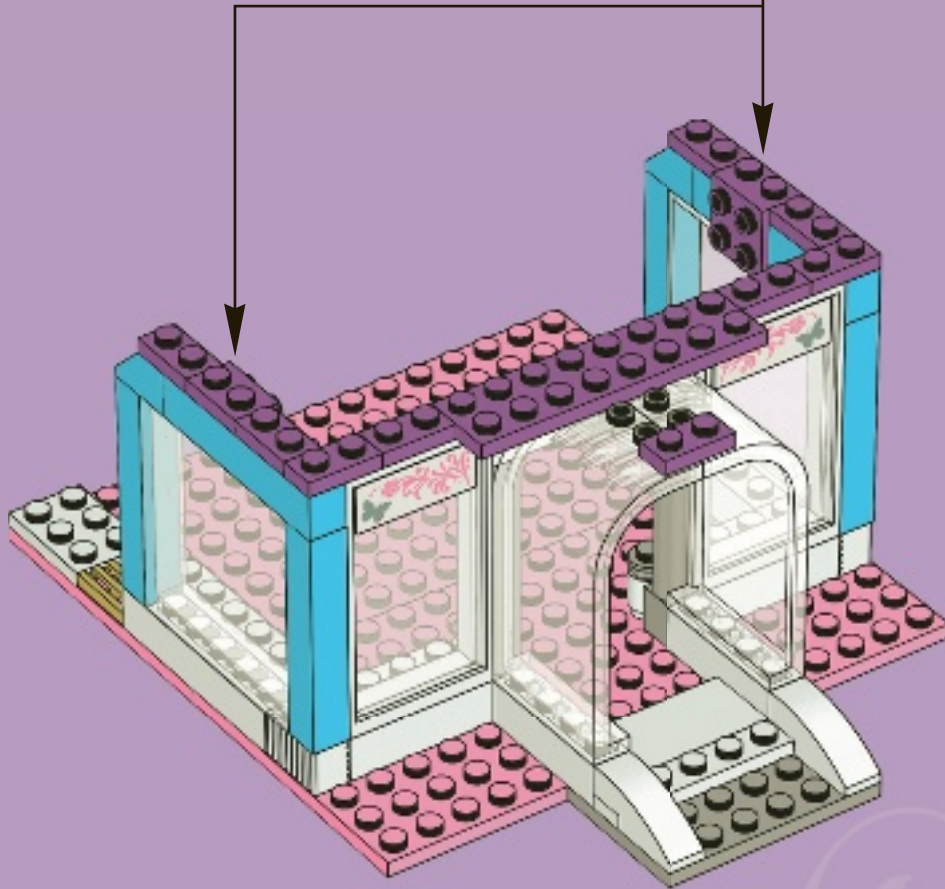
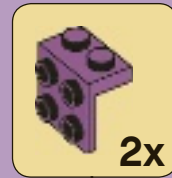

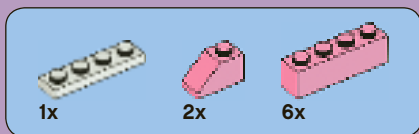

16

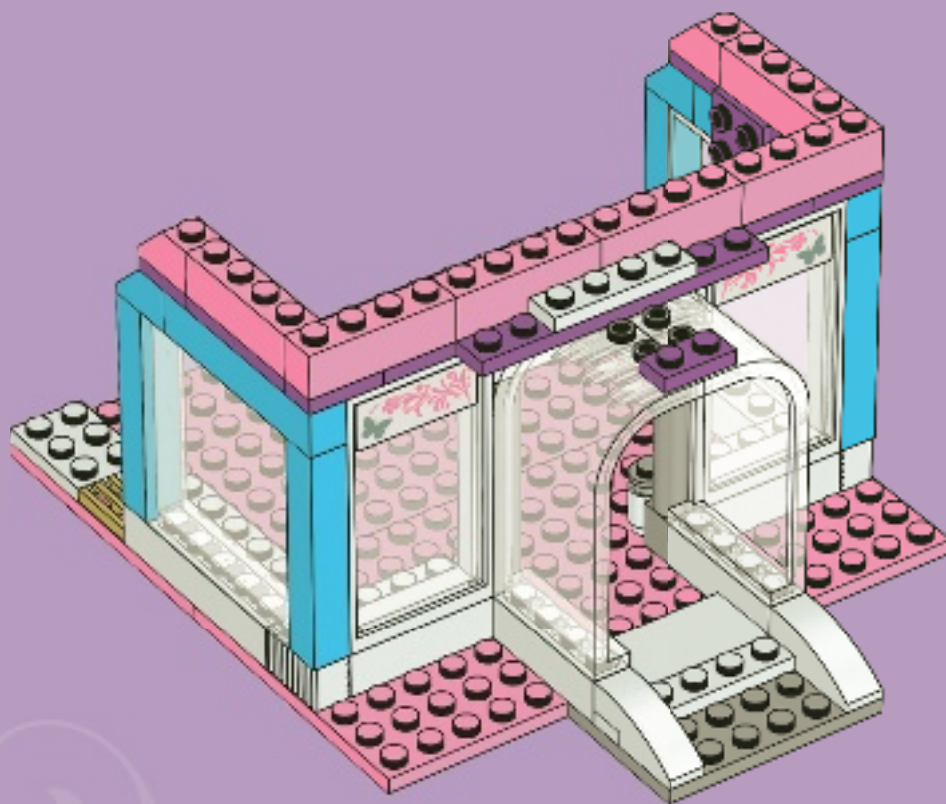



2x



1x

17

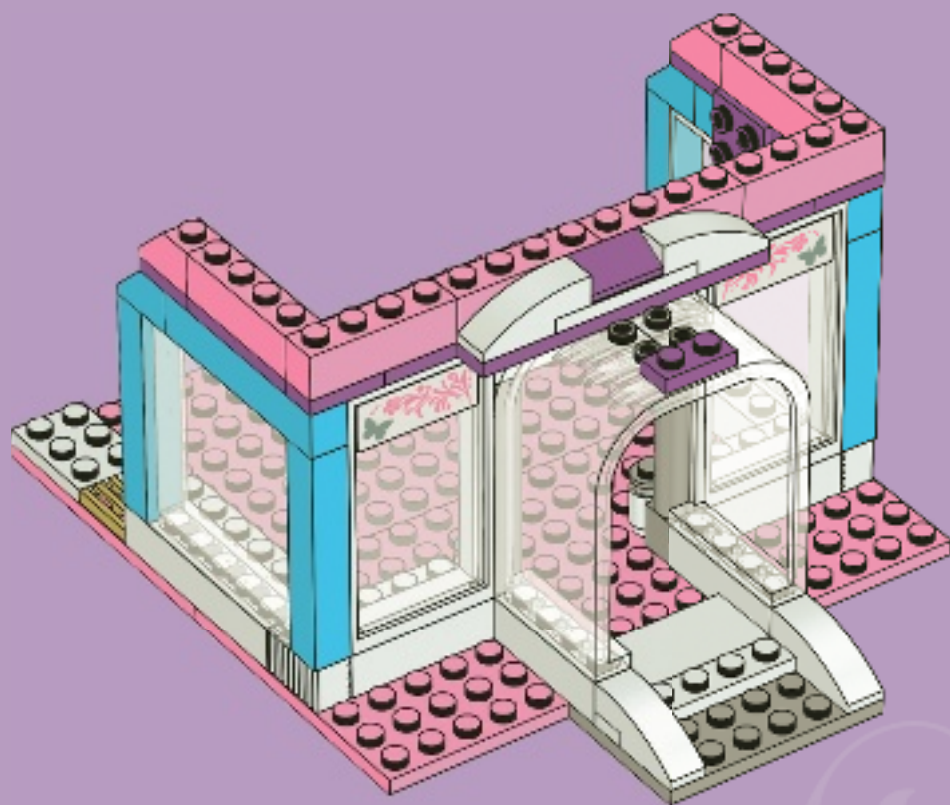



18

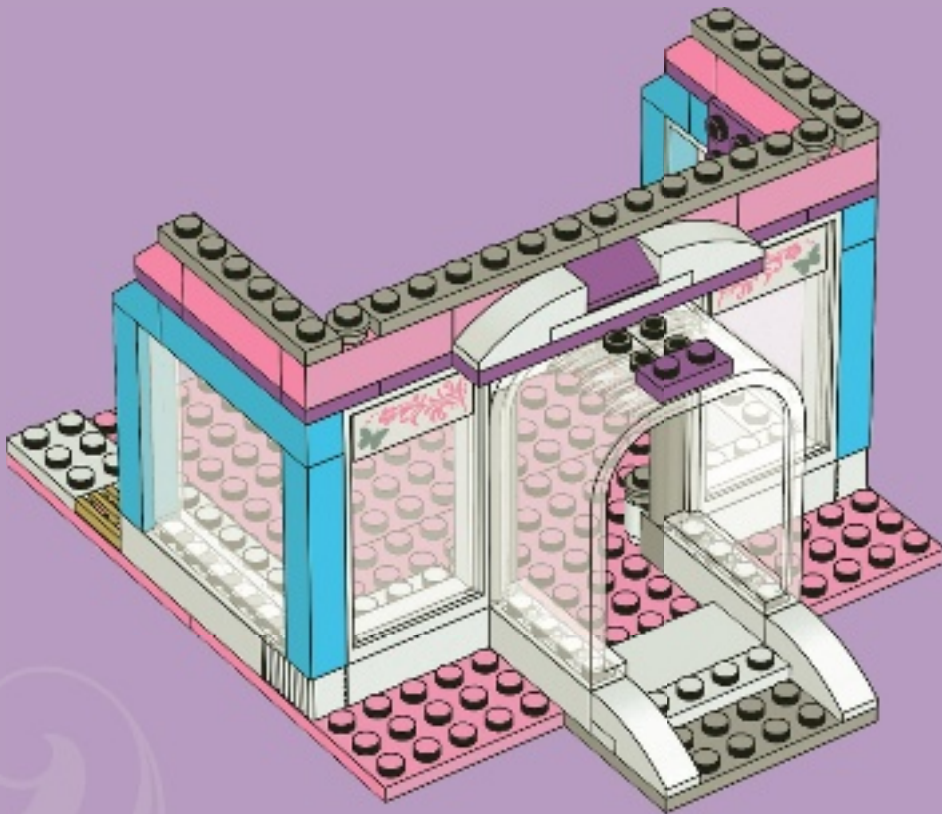



19

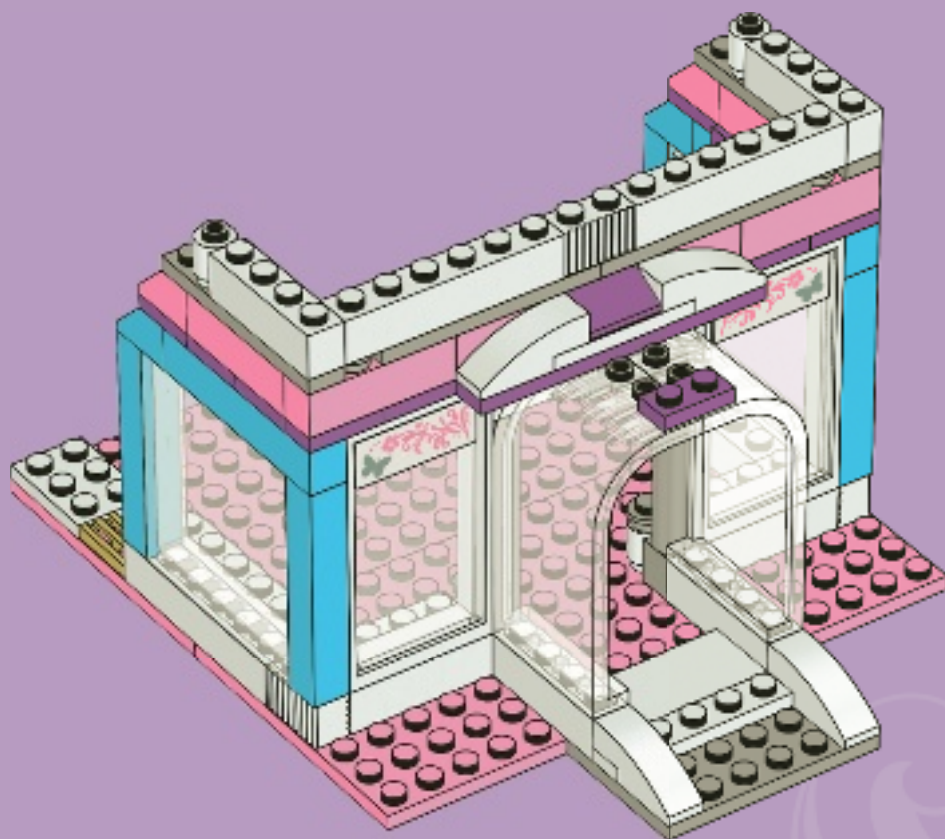



2x



6x

20

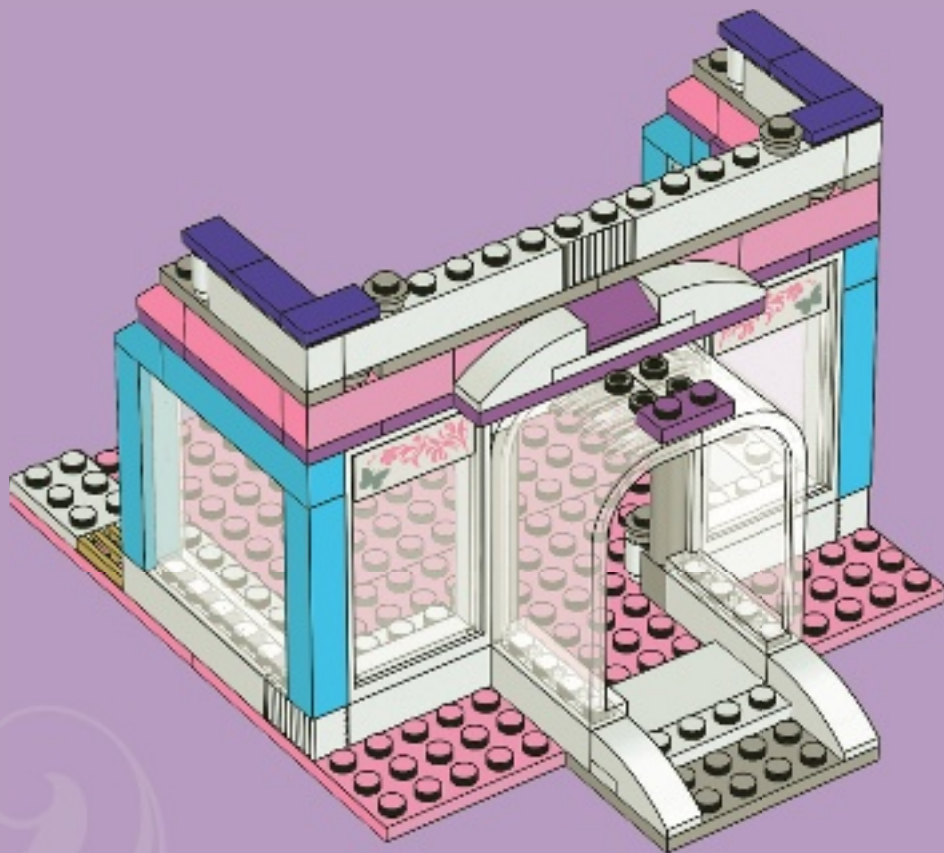



21

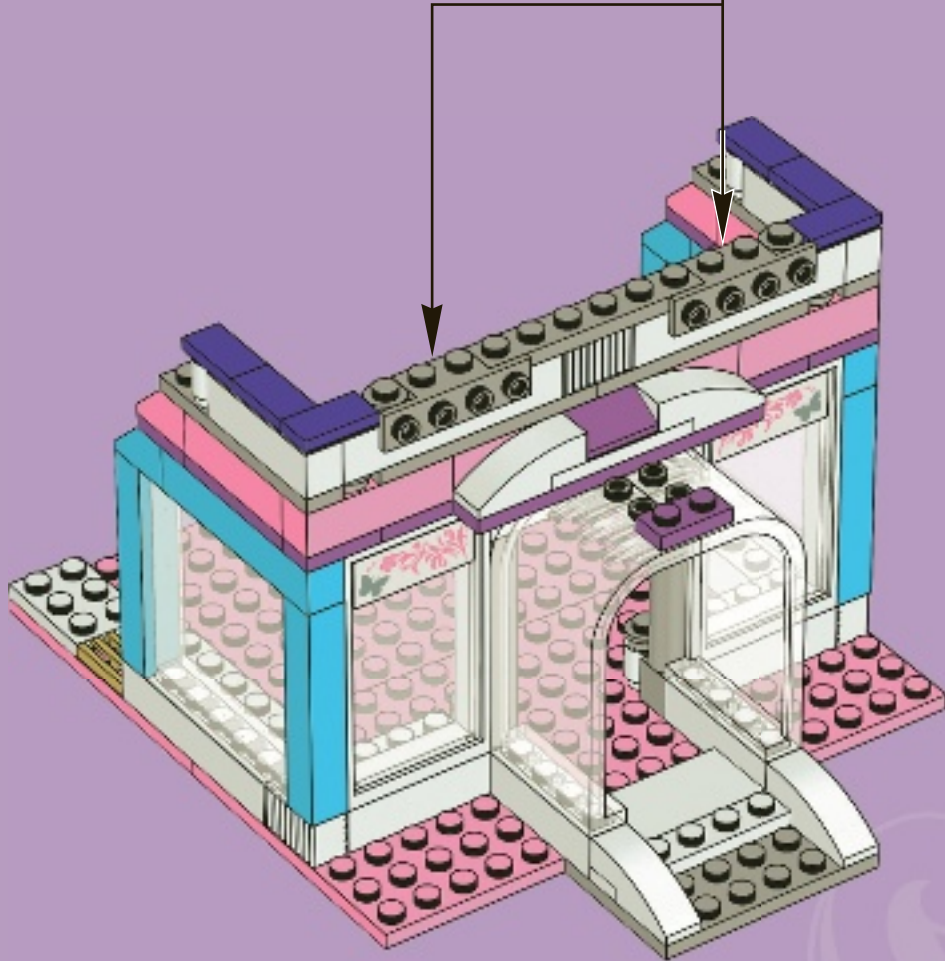
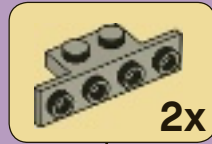

2

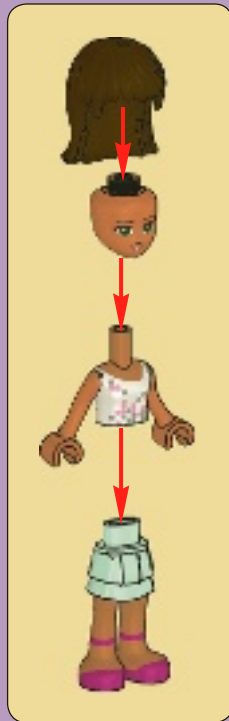

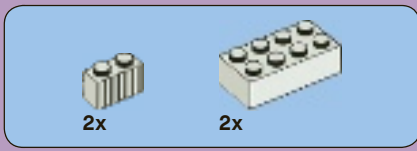

22

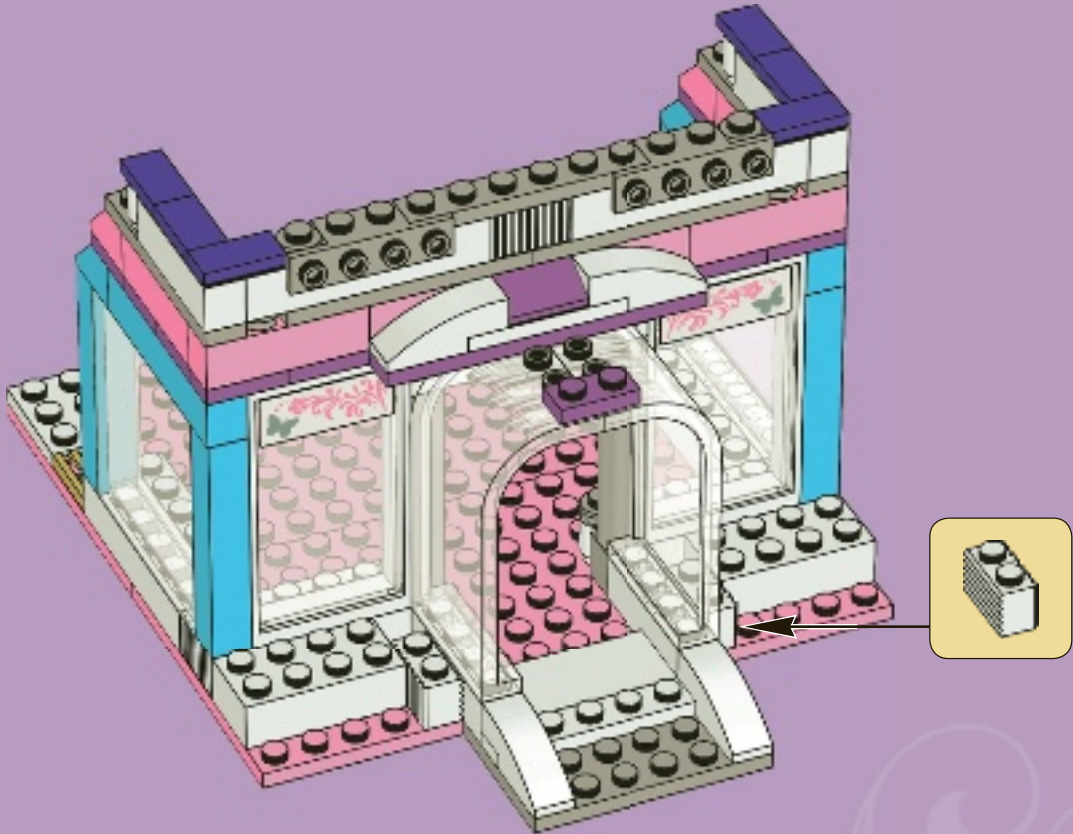



23

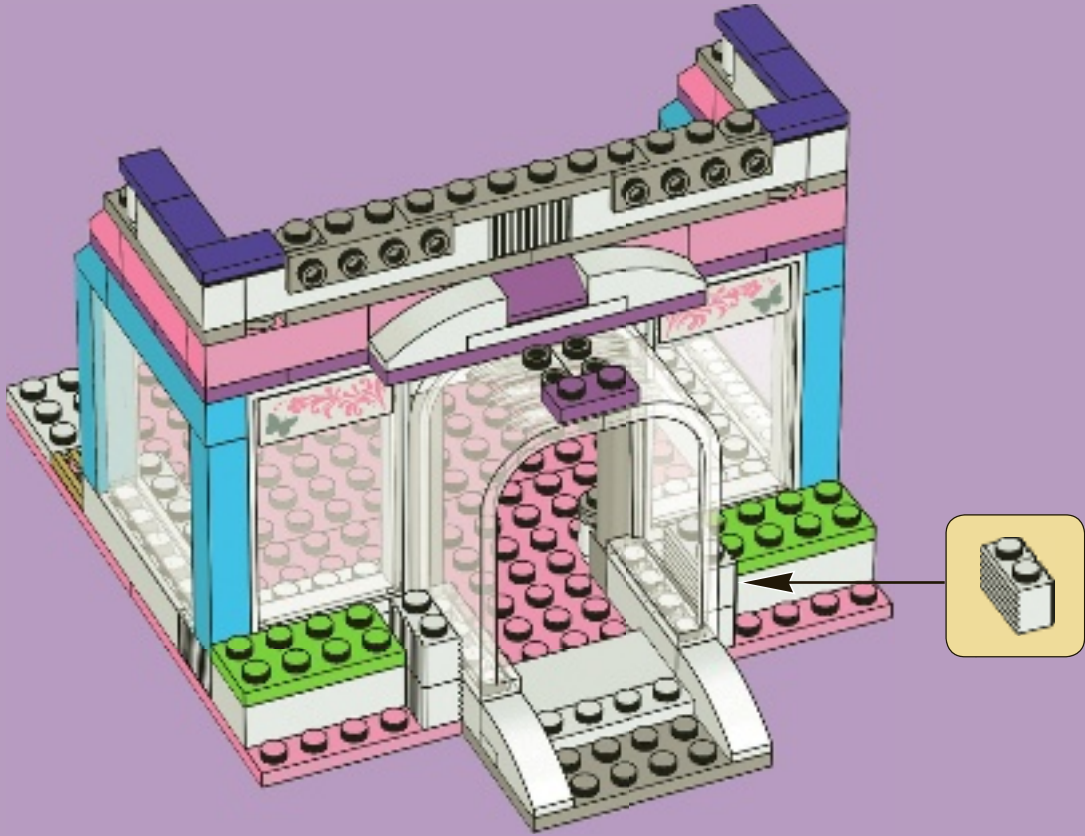

			
2x	2x	4x	2x

24

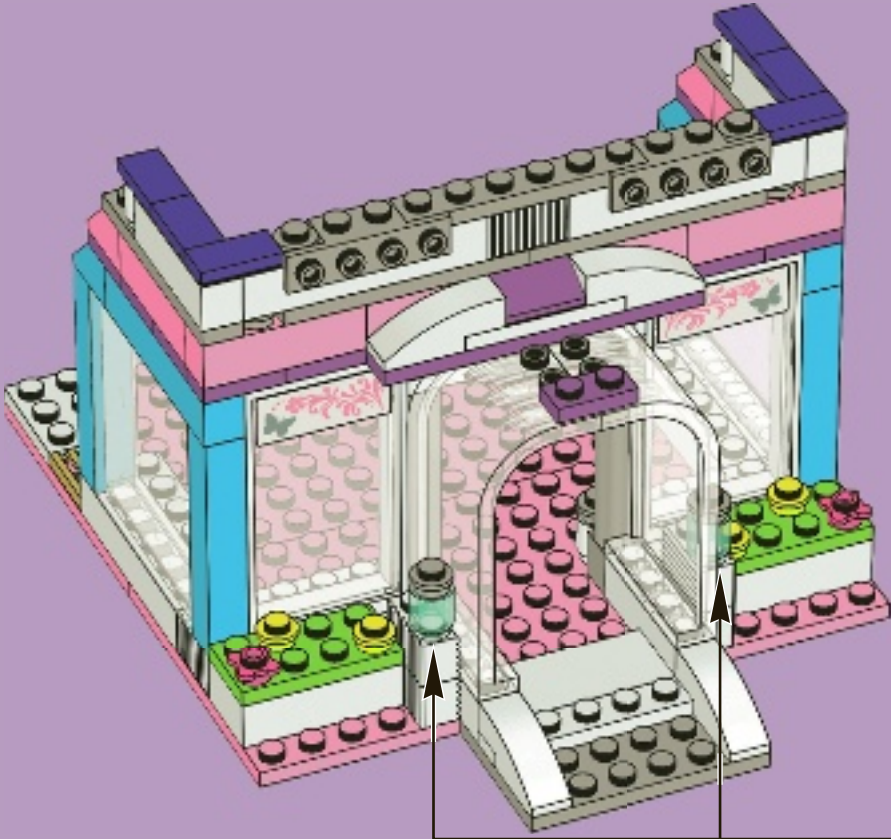
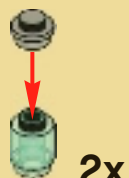
2x



1x

1



2x

2

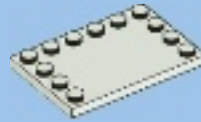

1x

3

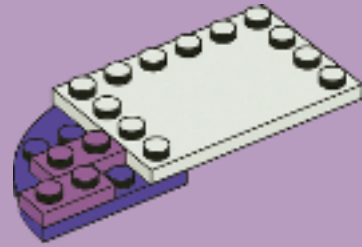

1x

4

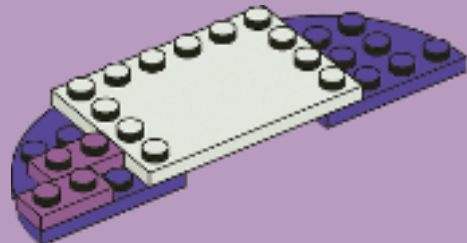



2x

5

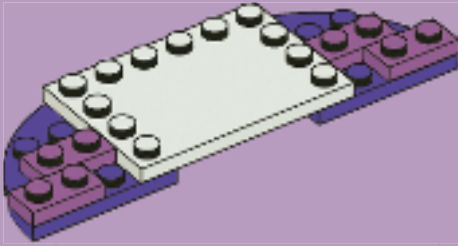

6

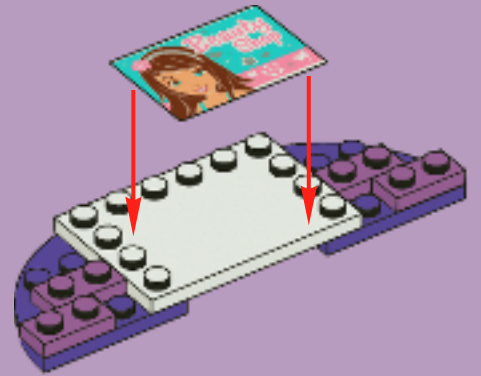

25

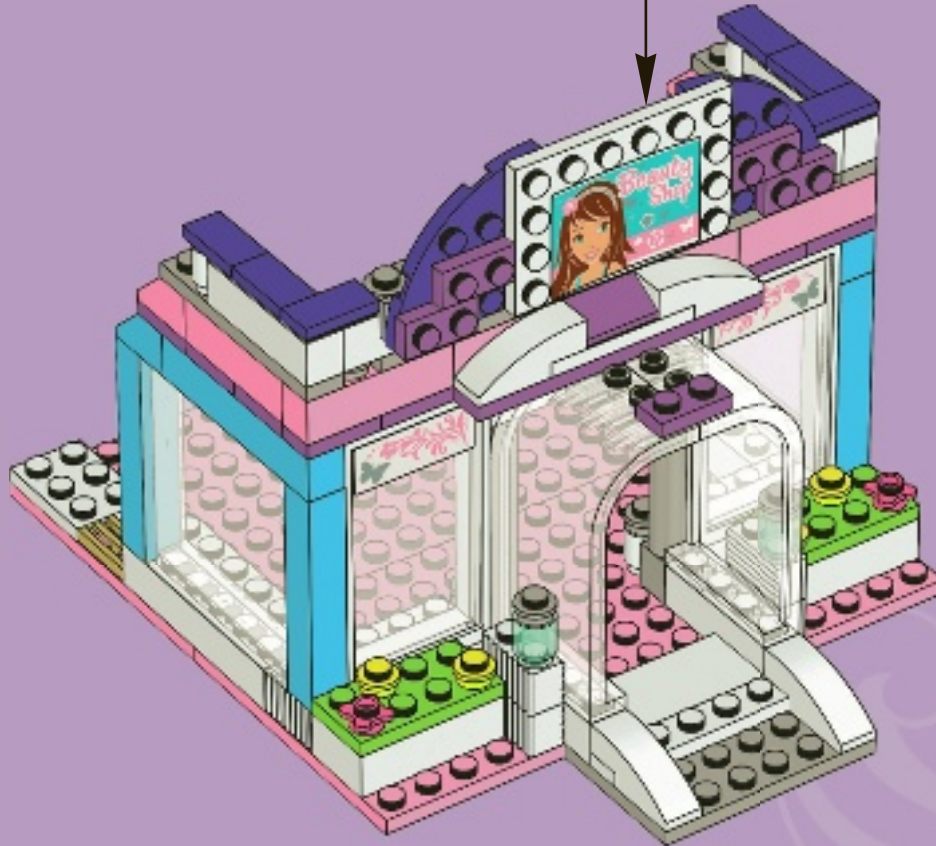



26

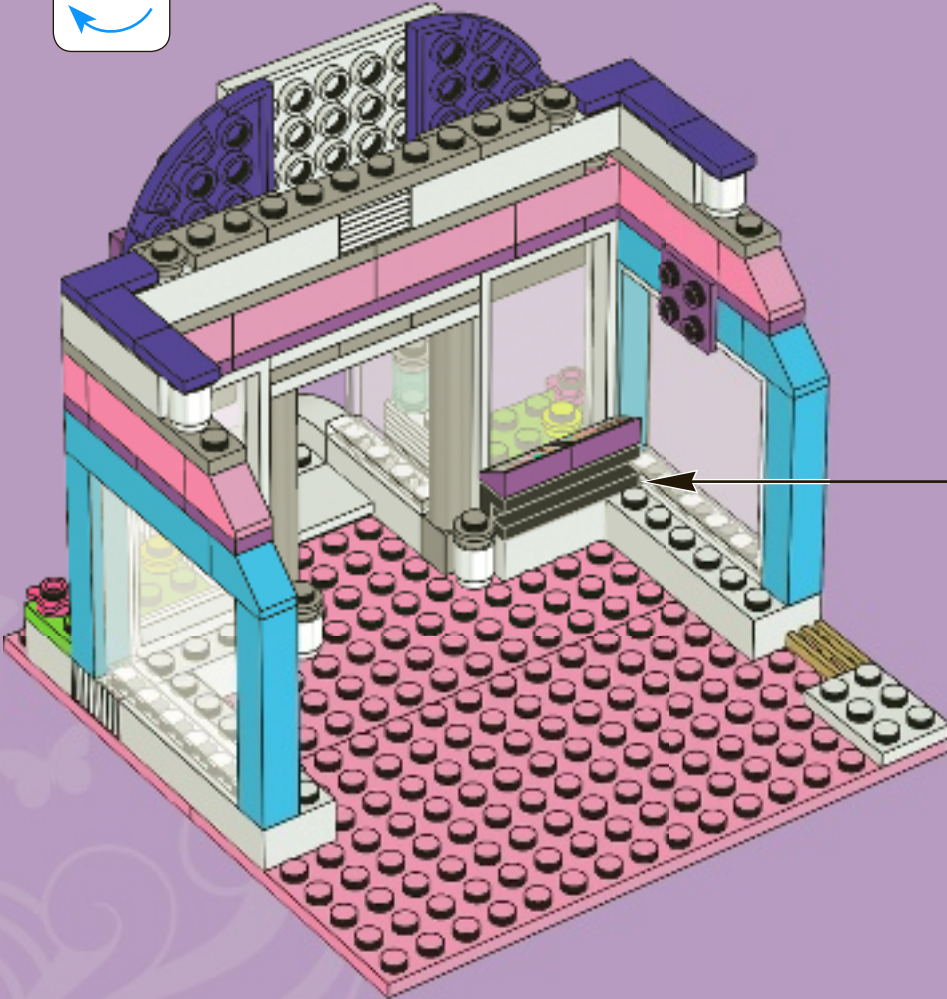
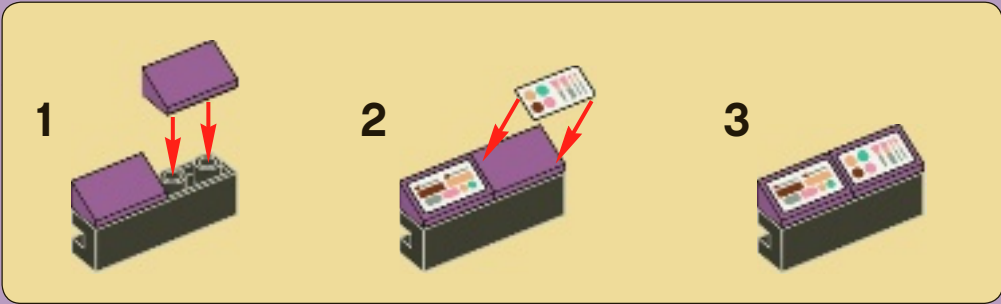



1x



2x

27

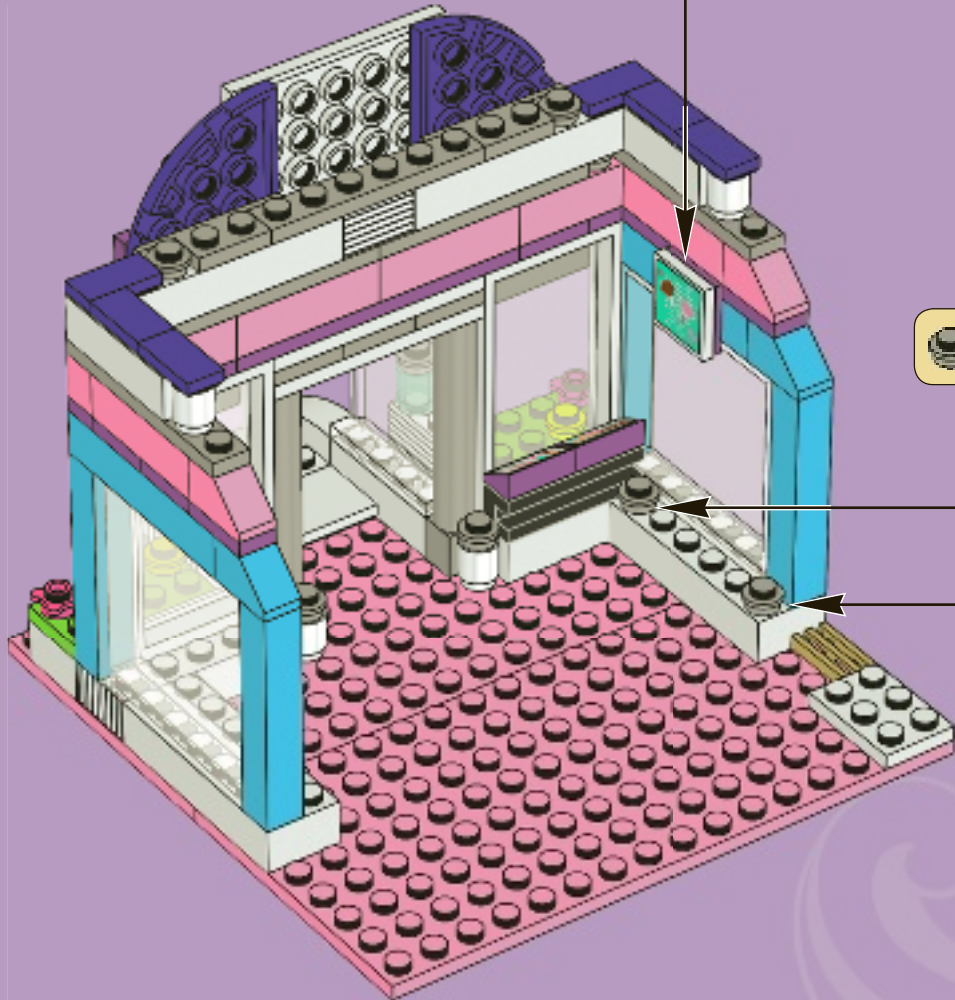
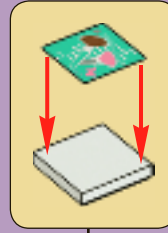

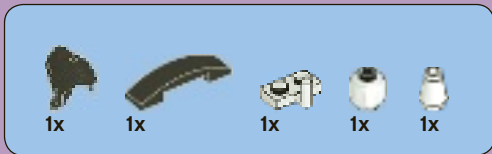

28

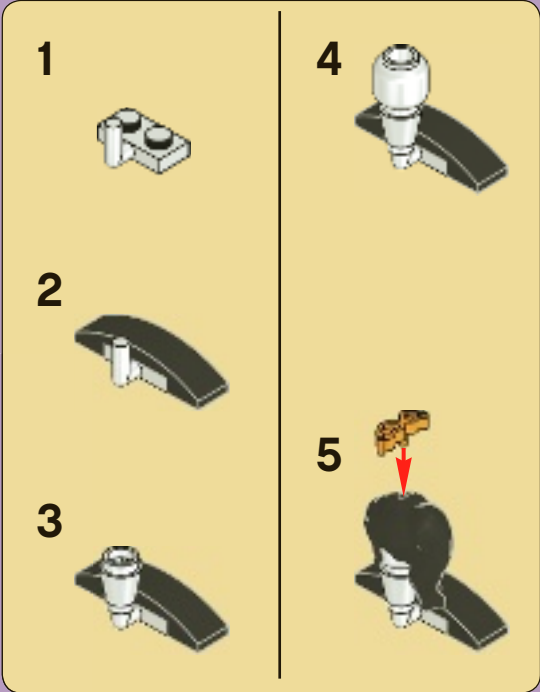
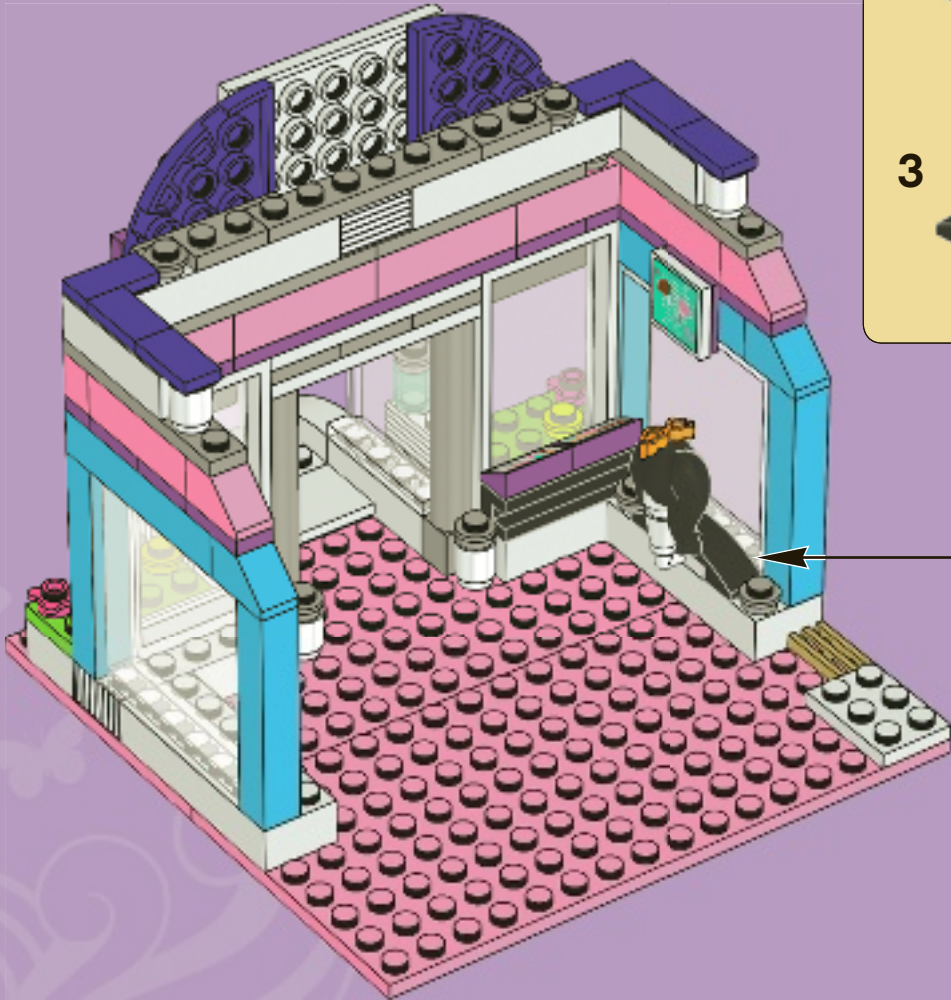



29

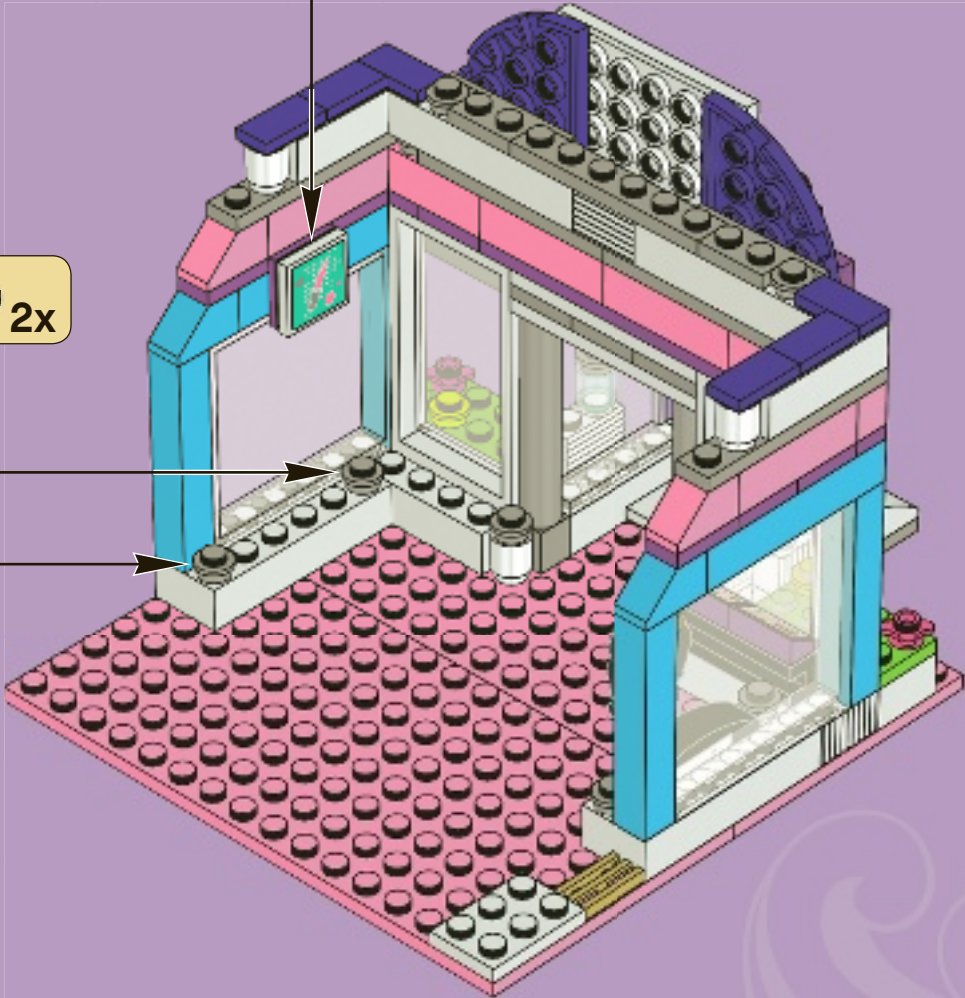
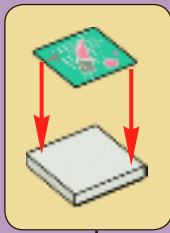

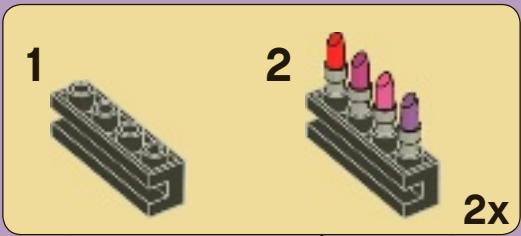

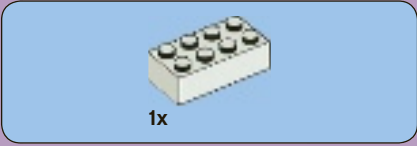

1

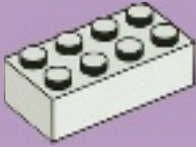

2

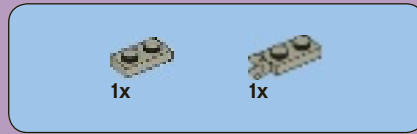
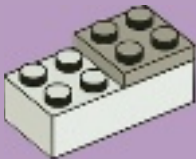

3

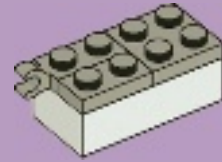

4

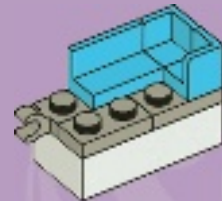



2x



1x

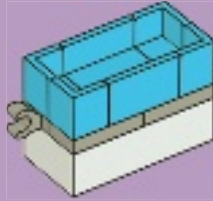

5

31



32



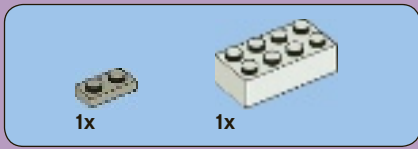

1

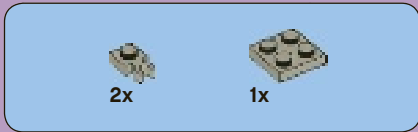
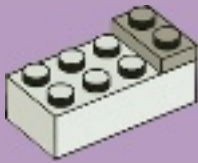

2



3

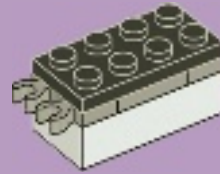

4

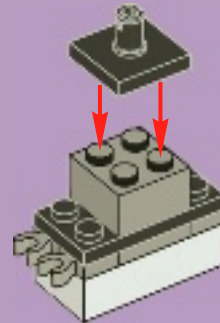



1x

5

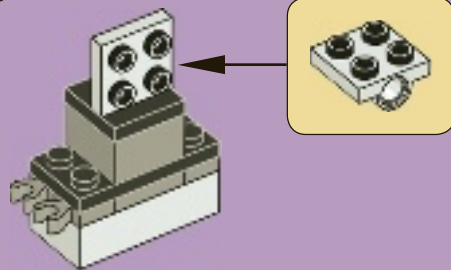

33



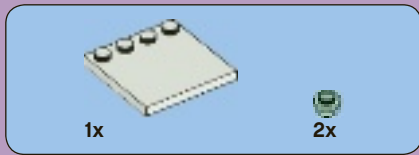

34

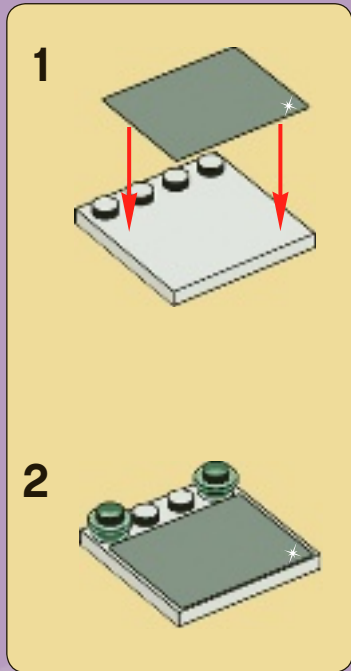



1x



1x



1x

35

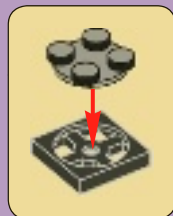



36

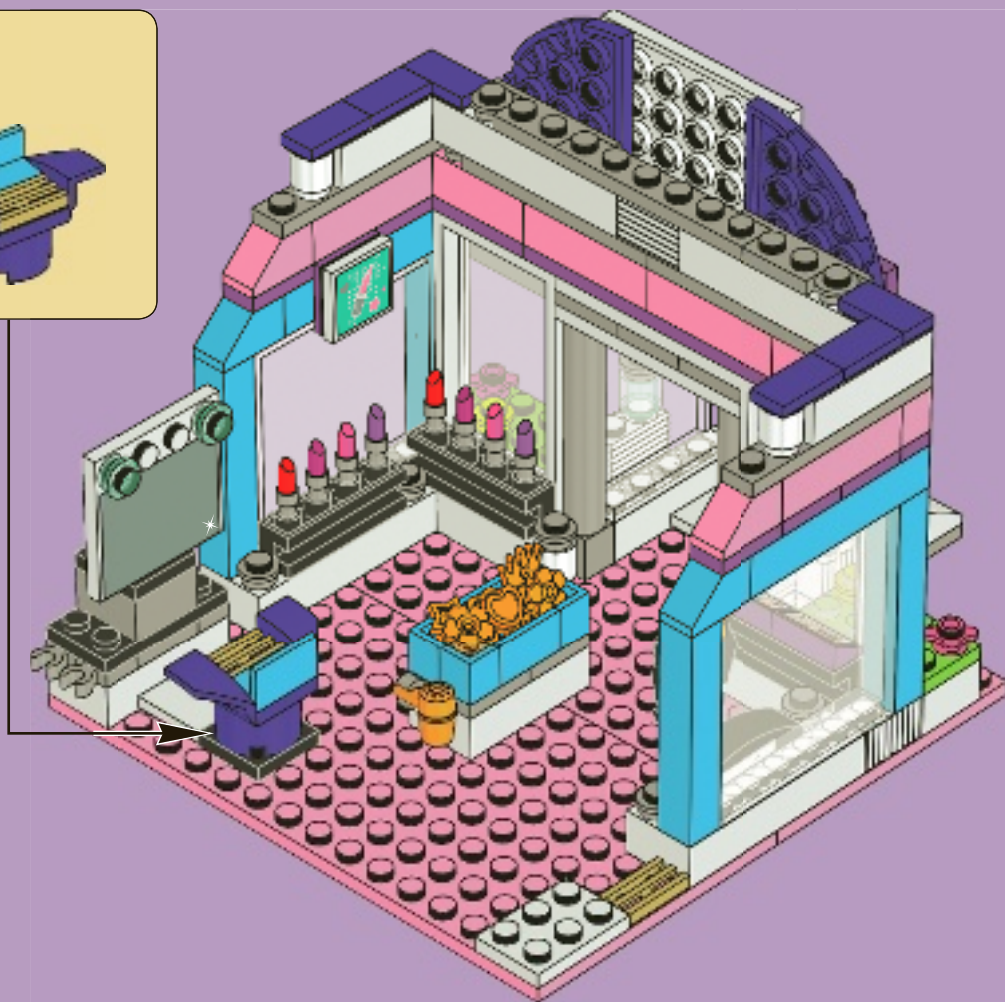
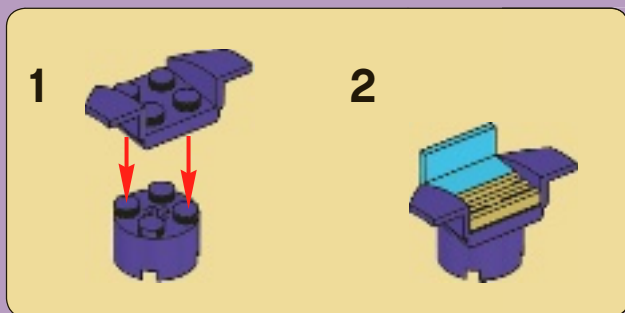

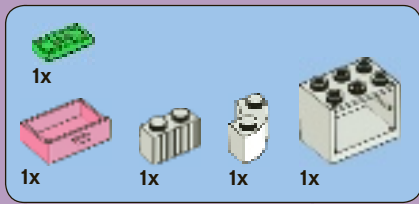

37

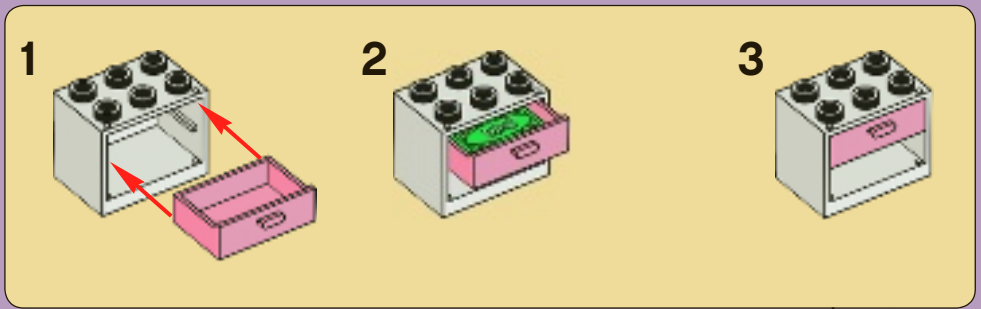



1x



1x

38





39





1x



1x

40





1x

41



42

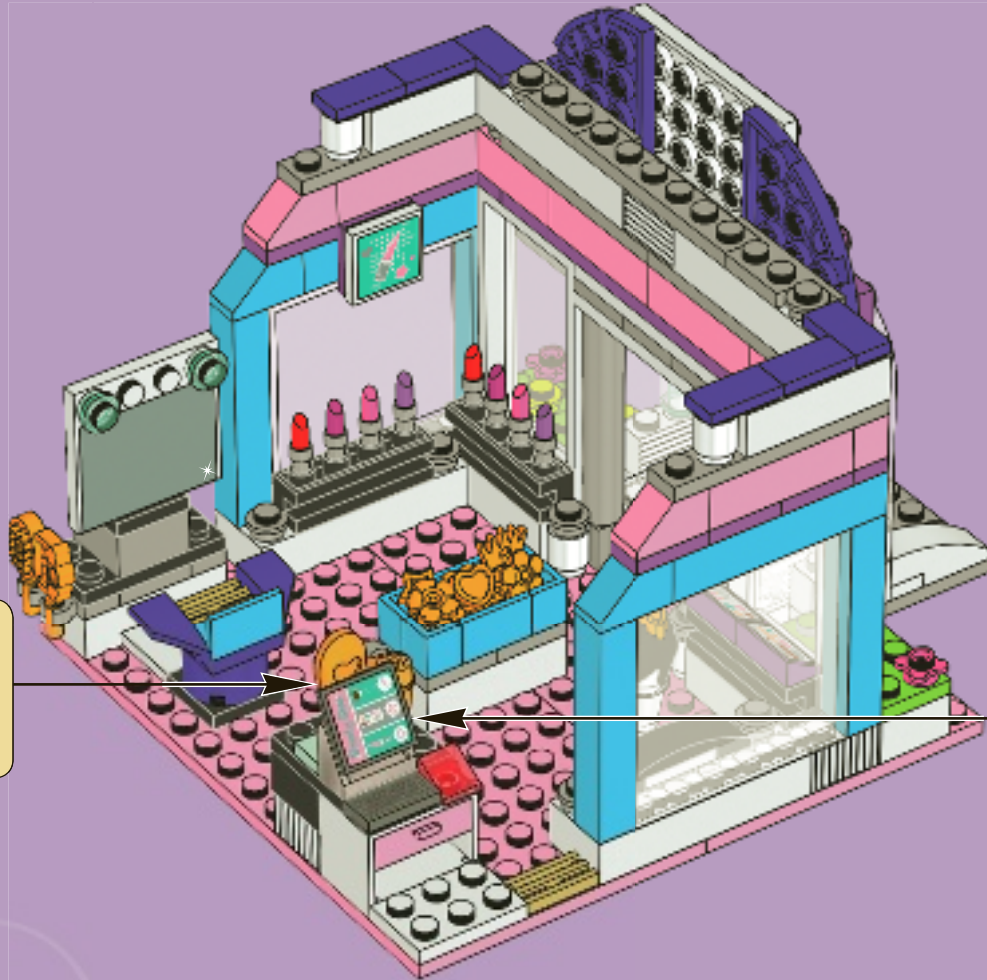



43

1

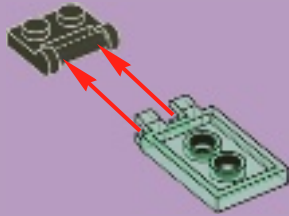

2



3

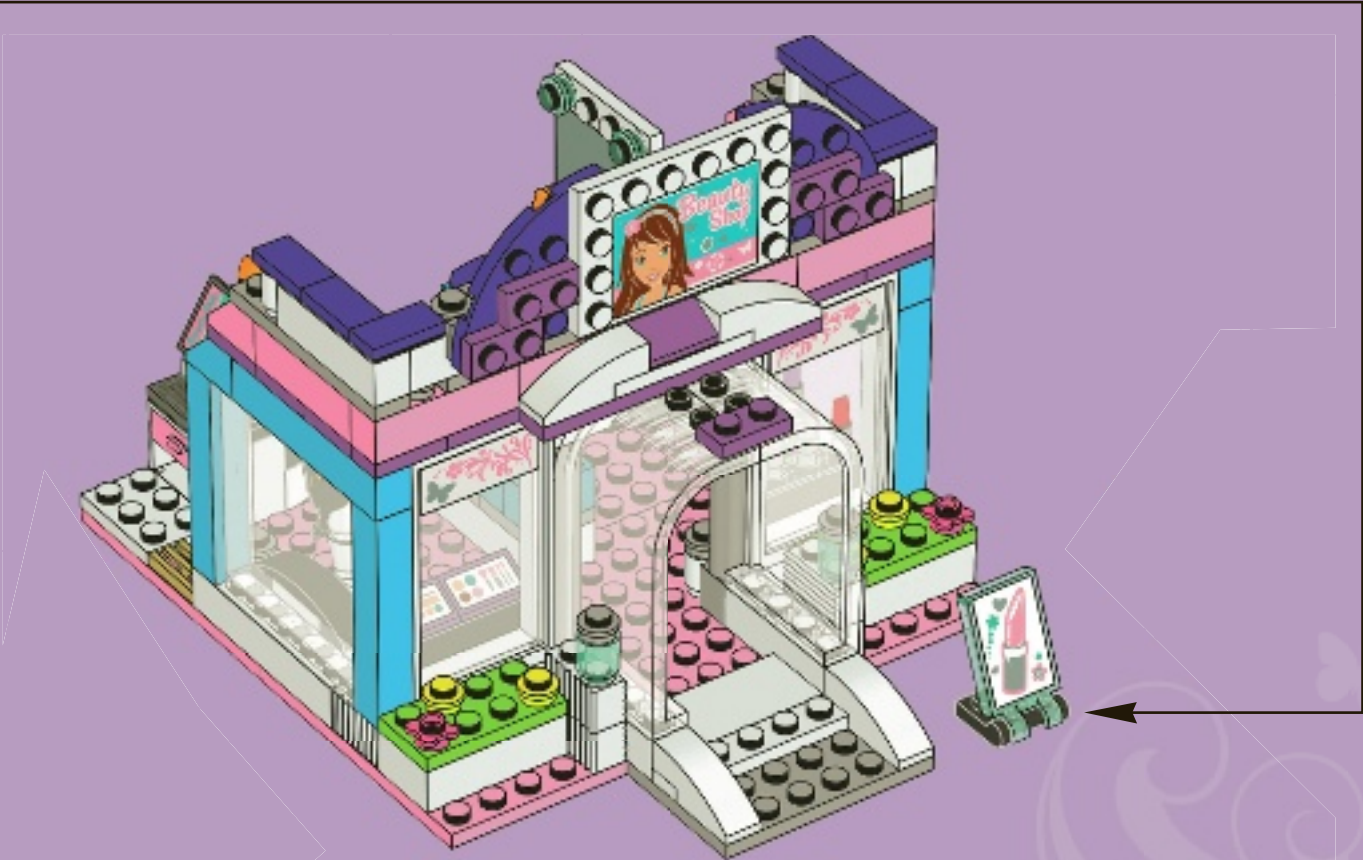



1



2

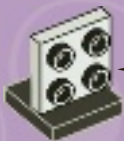

3

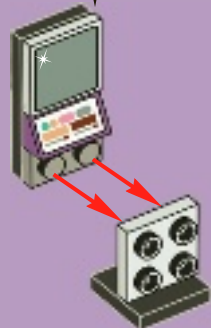
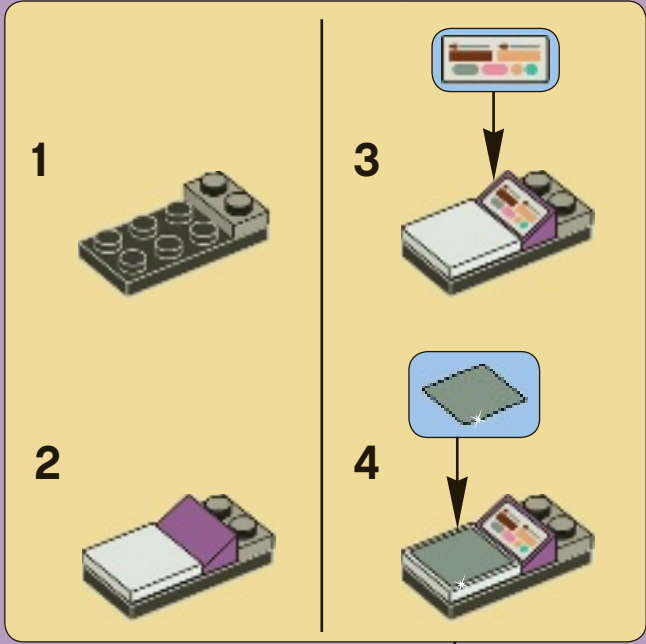

44



- 4x 301001
- 6x 300101
- 2x 300901
- 3x 4181142
- 8x 287701
- 1x 4518400
- 4x 306201
- 1x 4567449
- 1x 4216652
- 1x 4558956
- 1x 4611700
- 1x 4560178
- 4x 306801
- 2x 244401
- 4x 4249112
- 1x 302101
- 1x 371001
- 3x 366601
- 1x 617901
- 1x 4163986
- 1x 4619665
- 2x 4541956
- 1x 362601
- 2x 4124456
- 2x 4140562
- 4x 614124
- 1x 4556158
- 2x 4225201
- 1x 300426
- 3x 265326
- 1x 4567436
- 1x 4613153
- 2x 302026
- 2x 4258354
- 1x 4227392
- 1x 368026
- 1x 4295260
- 1x 4244363
- 3x 4183544
- 1x 4603191
- 2x 4163917
- 1x 4155537
- 2x 4537936
- 2x 4183133
- 3x 4216479
- 6x 4518890
- 2x 4517995
- 1x 4599534
- 2x 4639698
- 2x 4617483
- 2x 4504229
- 1x 4650864
- 1x 4210701
- 1x 4614461
- 1x 4625231
- 1x 4622176
- 6x 4613192
- 1x 4566804
- 2x 4619639
- 1x 4211387
- 2x 4179576
- 7x 4211398
- 3x 4211397
- 5x 4211438
- 1x 4211404
- 2x 4594238
- 1x 4535738
- 2x 4282740
- 12x 4211525
- 1x 4515351
- 1x 4540203
- 1x 4211815
- 1x 4493478
- 4x 4619635
- 2x 4619653
- 2x 4619655
- 3x 4624705
- 4x 4618645
- 3x 4618647
- 1x 4657469
- 1x 4600258
- 1x 4612389
- 1x 4621988
- 2x 4624569
- 2x 4624571
- 2x 4599741
- 2x 4624567
- 1x 4596243
- 1x 4646910
- 1x 4612388
- 1x 4622795
- 1x 4611979
- 2x 4619647
- 4x 4625024
- 13x 4619512
- 1x 4619648
- 1x 6001515
- 2x 4610355

Customer Service
Kundenservice
Service Consommateurs
Servicio Al Consumidor
www.lego.com/service or dial
 00800 5346 5555 :     
 1-800-422-5346 :  

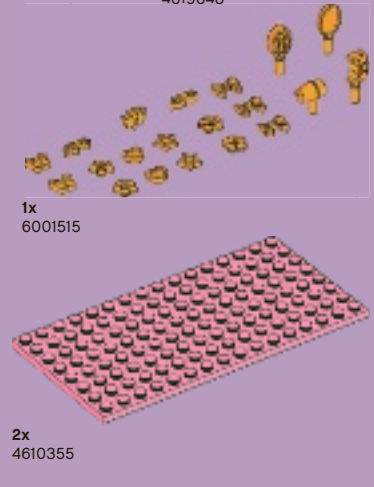



Friends

LEGOFriends.com



Emma



Olivia

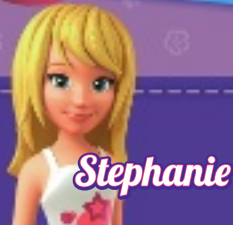

Stephanie



Mia



Andrea

Heartlake City



LEGO Friends



3183



3061



3065



3931



3187



3935



3932



3930



3933



3936



3934



3942



3188



3315



Win!

Go to www.LEGOsurvey.com/product to fill out a survey for a chance to win a cool LEGO® Product.

No purchase necessary.
Open to all residents where not prohibited.

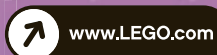

www.LEGOsurvey.com/product

Gewinne! Win!

Nimm an der Umfrage auf www.LEGOsurvey.com/product teil und hab die Chance ein cooles LEGO® Produkt zu gewinnen!

Die Teilnahme am Gewinnspiel führt zu keinerlei Kaufverpflichtungen. Teilnahme in allen nicht ausgeschlossenen Ländern möglich.

Ga naar www.LEGOsurvey.com/product, vul een enquêteformulier in en maak kans op een cool LEGO® product.

Geen aankoopverplichting, iedereen mag deelnemen, uitgezonderd ingezetenden van landen waar een enquêteverbod geldt.

Gagne! 当てよう!

Visite www.LEGOsurvey.com/product pour répondre à un questionnaire et avoir une chance de gagner un produit LEGO® très cool!

Aucune obligation d'achat. Ouvert à tous les résidents des pays autorisés.

www.LEGOsurvey.com/product にアクセスして、アンケートにご記入ください。当選者にはレゴ製品を差し上げます。

お買い上げの必要はありません。
禁止されていない限り、すべての皆様にご利用いただけます。