



# CREATOR™

# 3 IN 1

31138



3 in 1  
3 en 1  
3 em 1  
3 合 1

3 w 1  
3 v 1  
3 az 1-ben  
3 in 1

„3 в 1“  
Kolm ühes  
3 viename

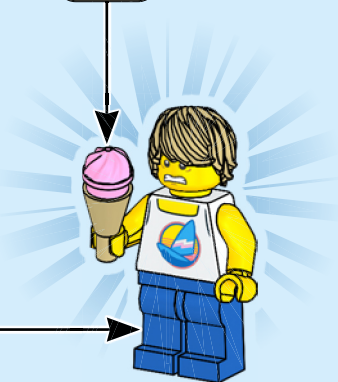
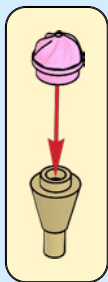
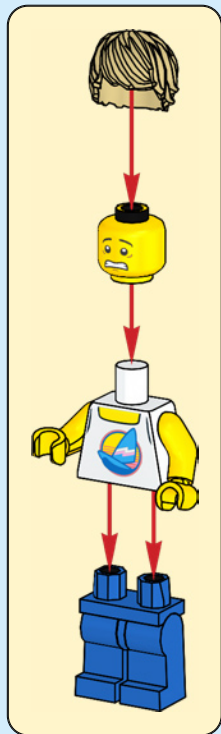



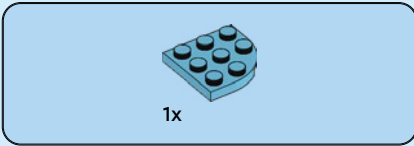
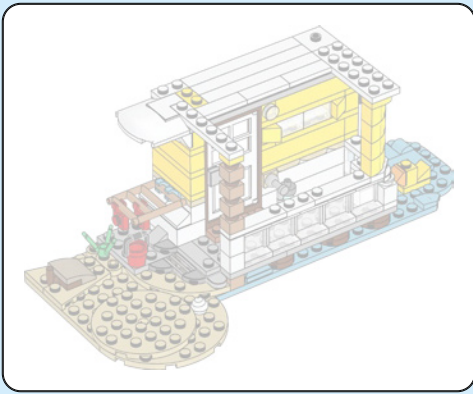

1

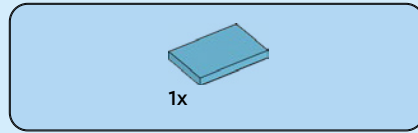
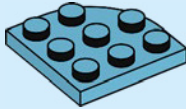

2

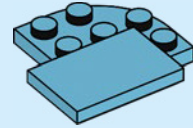

3

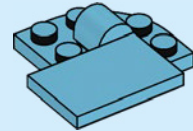





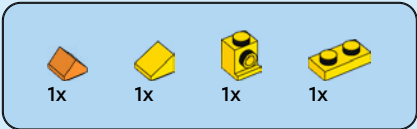

8

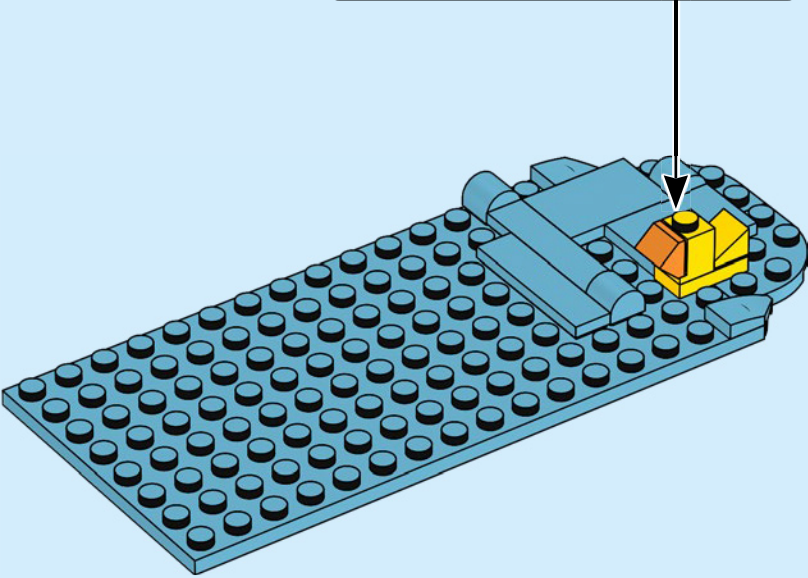
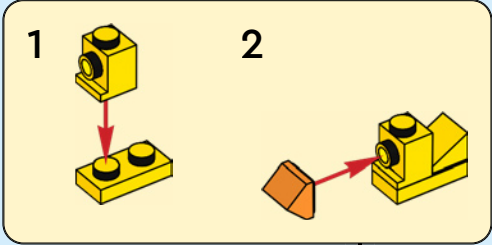

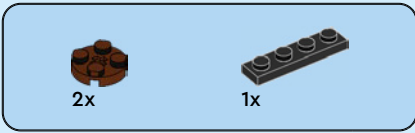

9

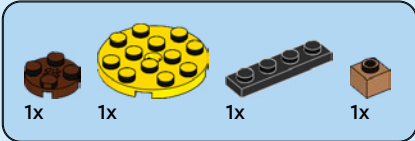
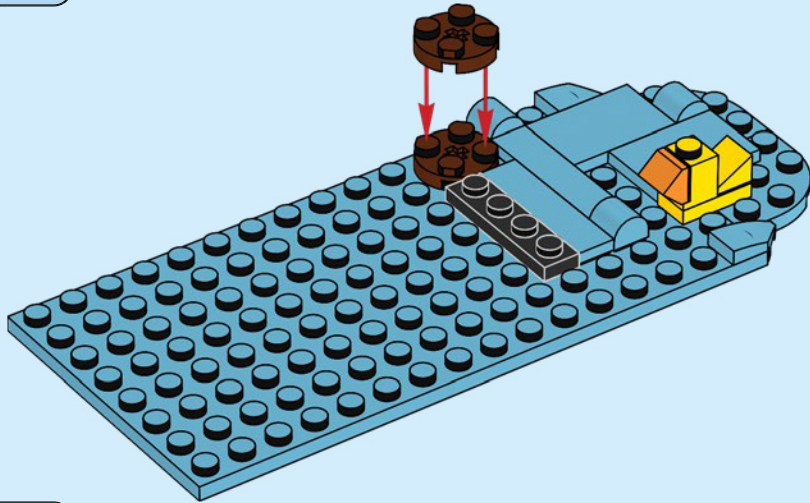

10

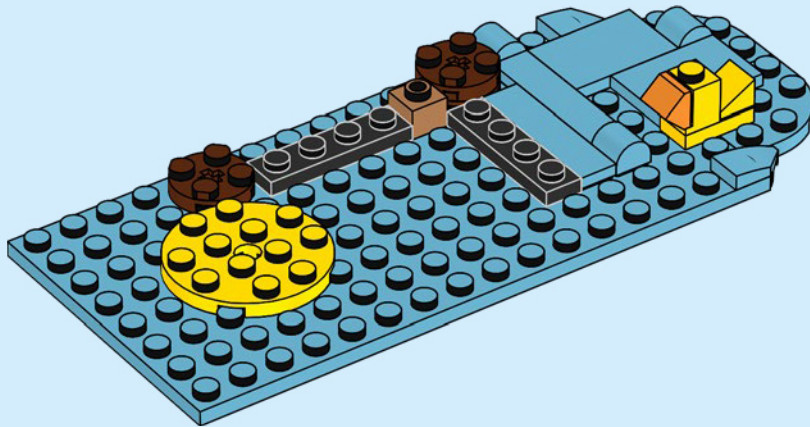



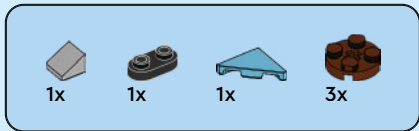

11

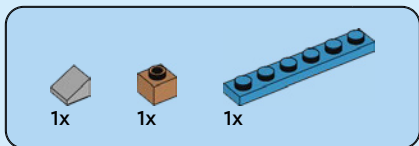
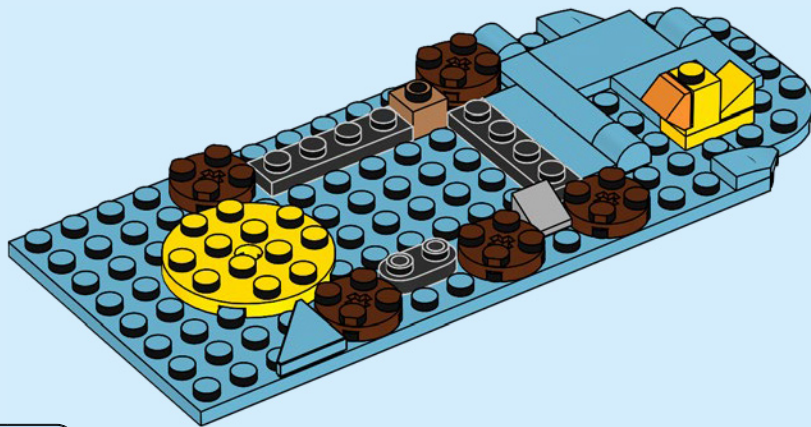

12

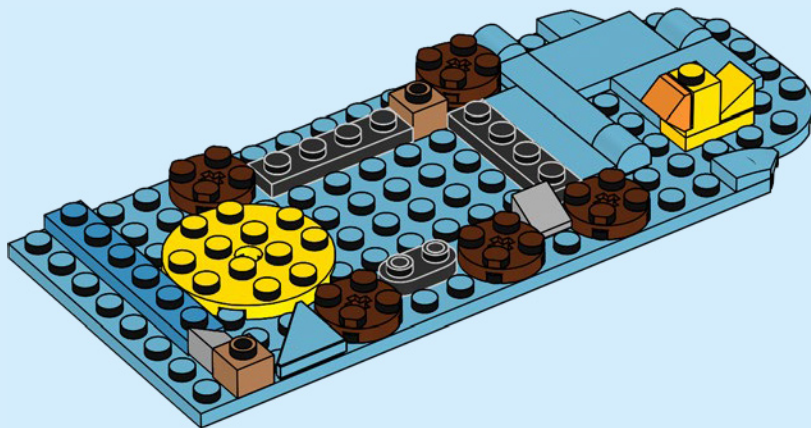



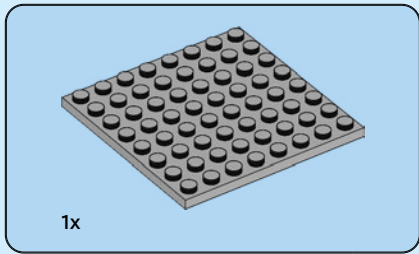

15

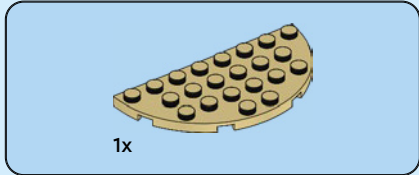
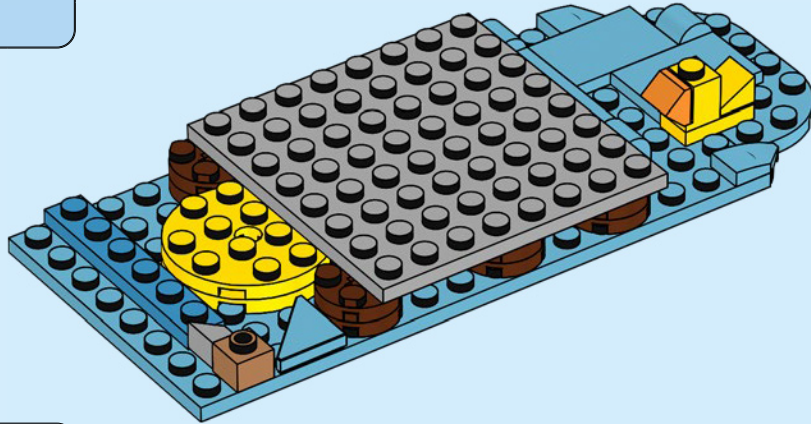

16

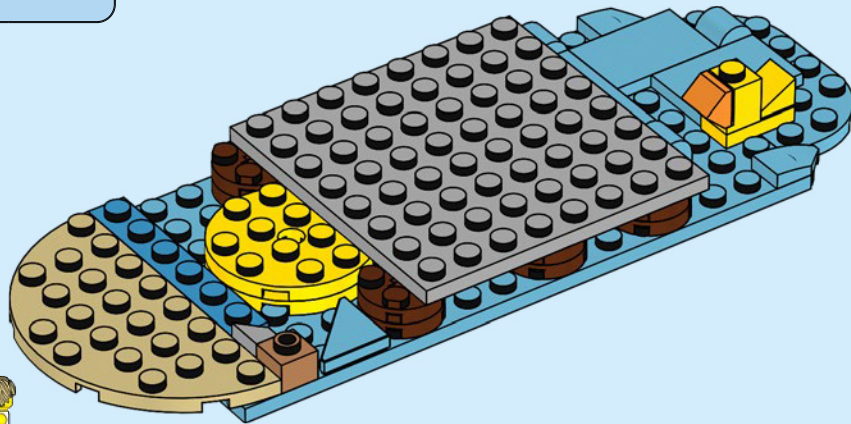

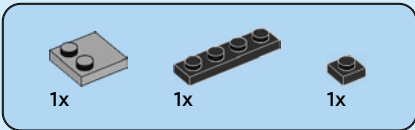

17

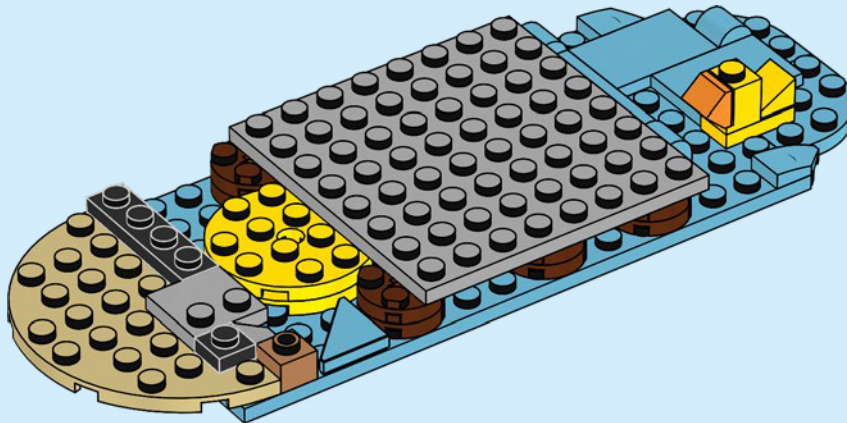

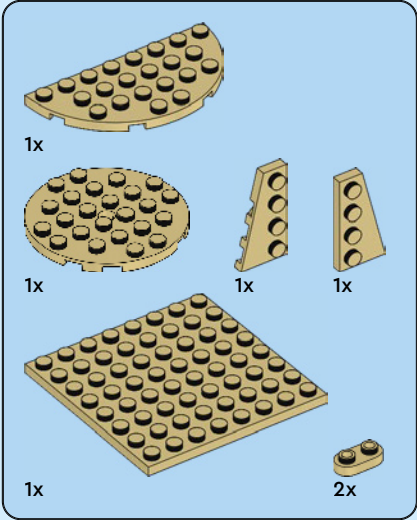
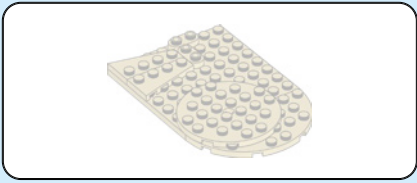

18

1

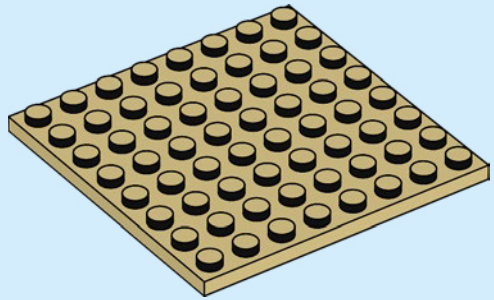

2

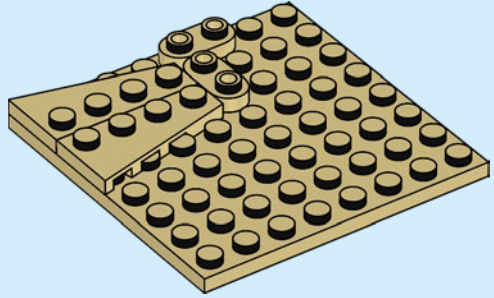



3

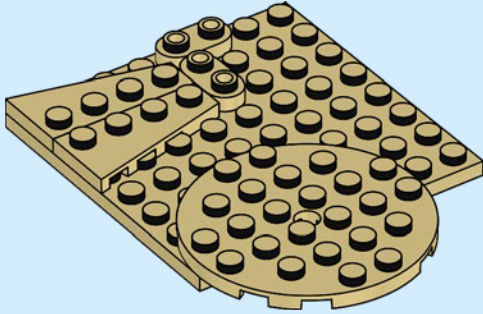

4

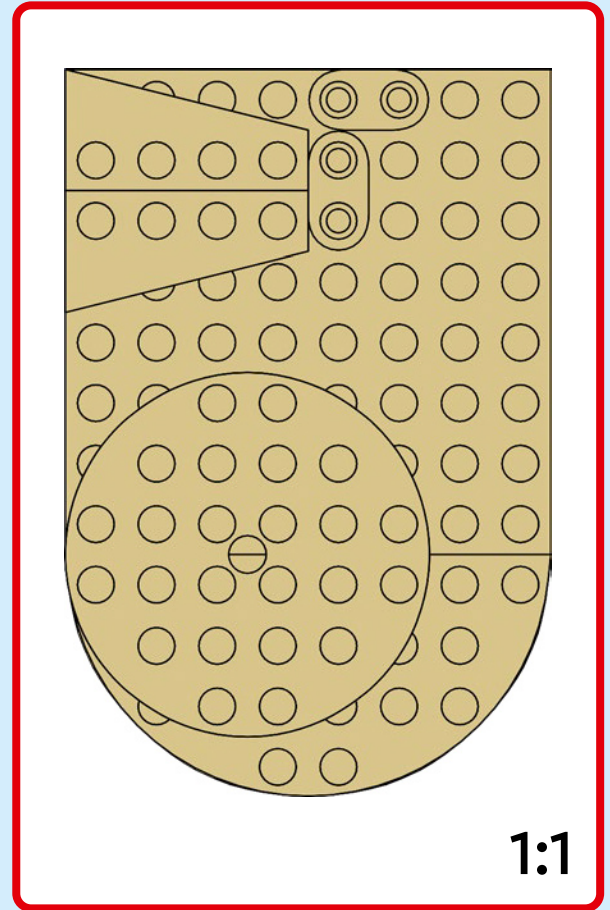
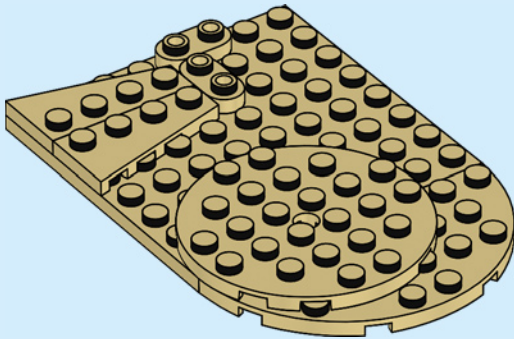

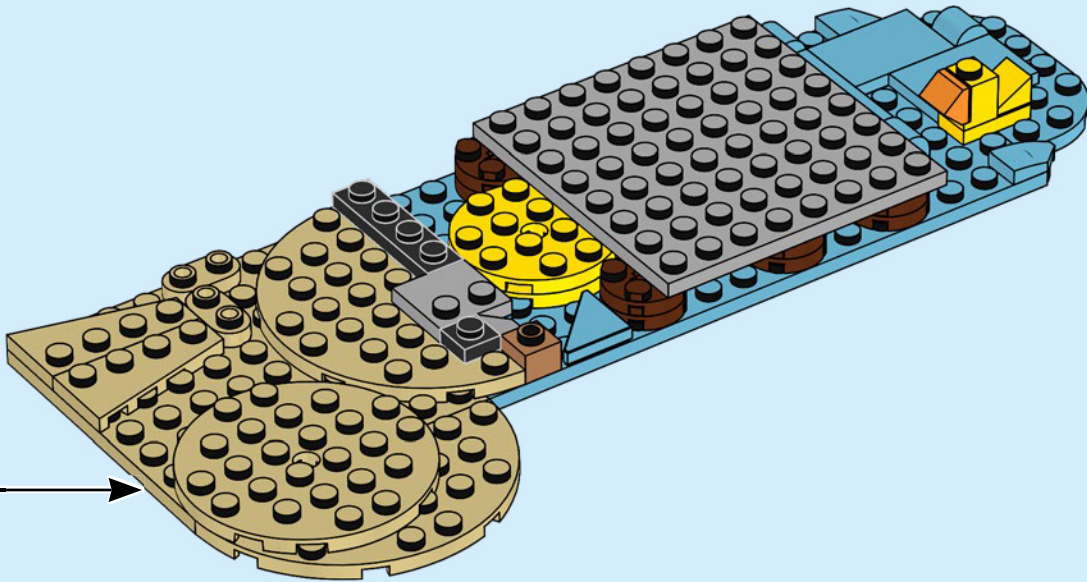

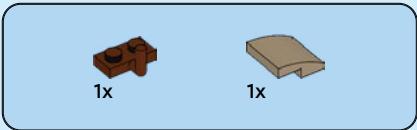

19

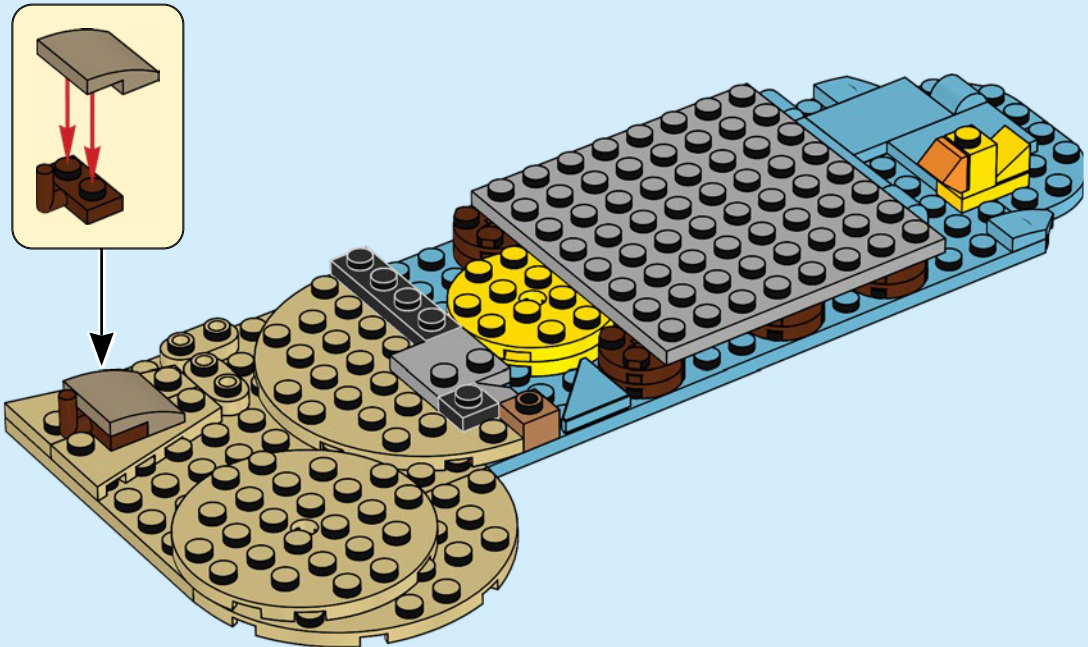

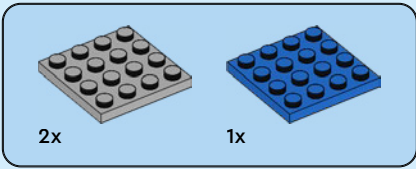

20

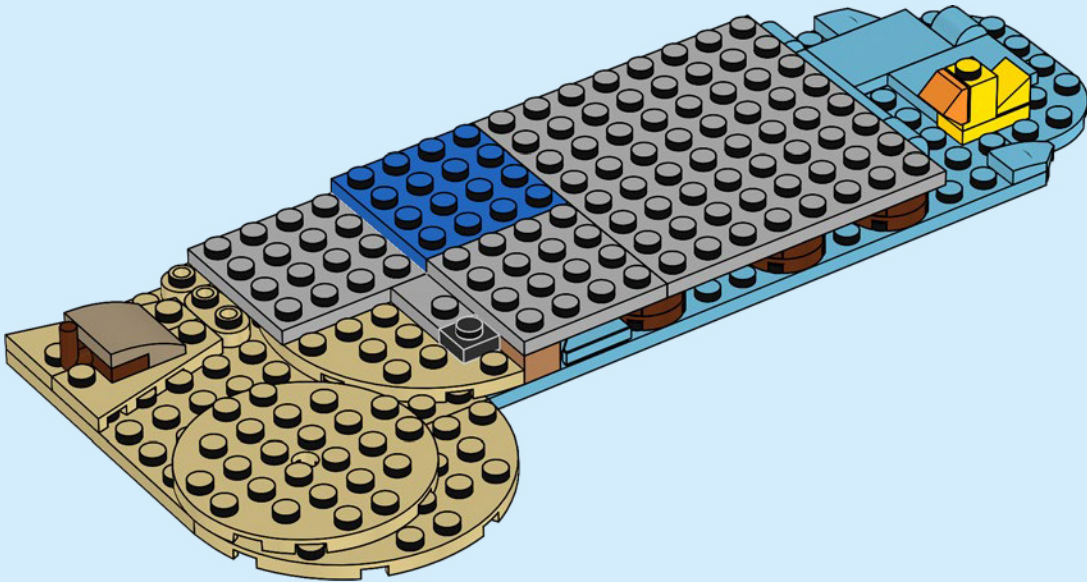

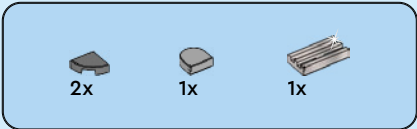

21

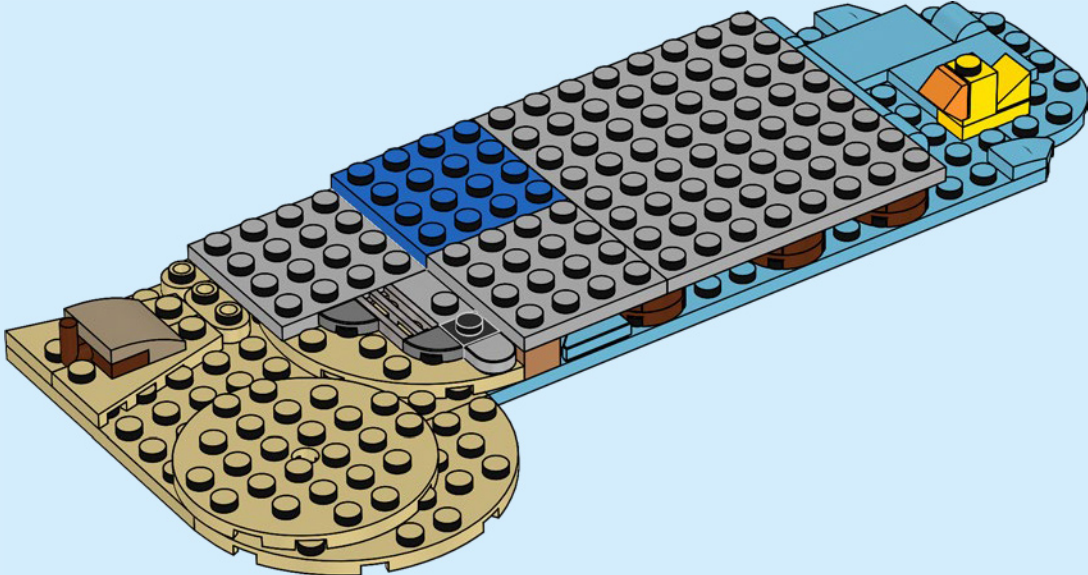



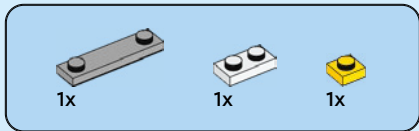

22

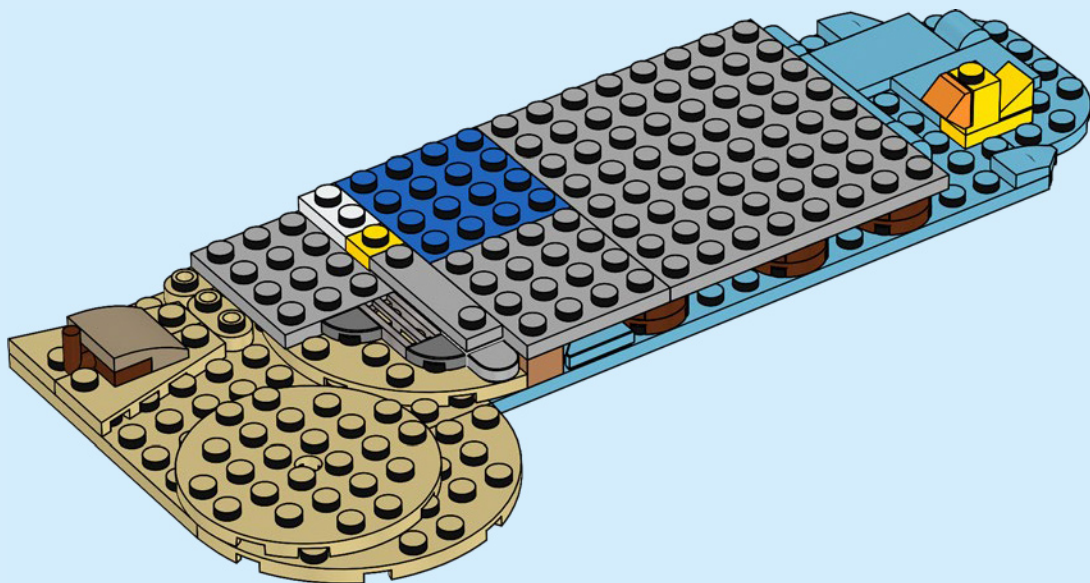

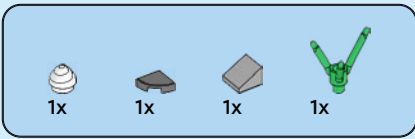

23

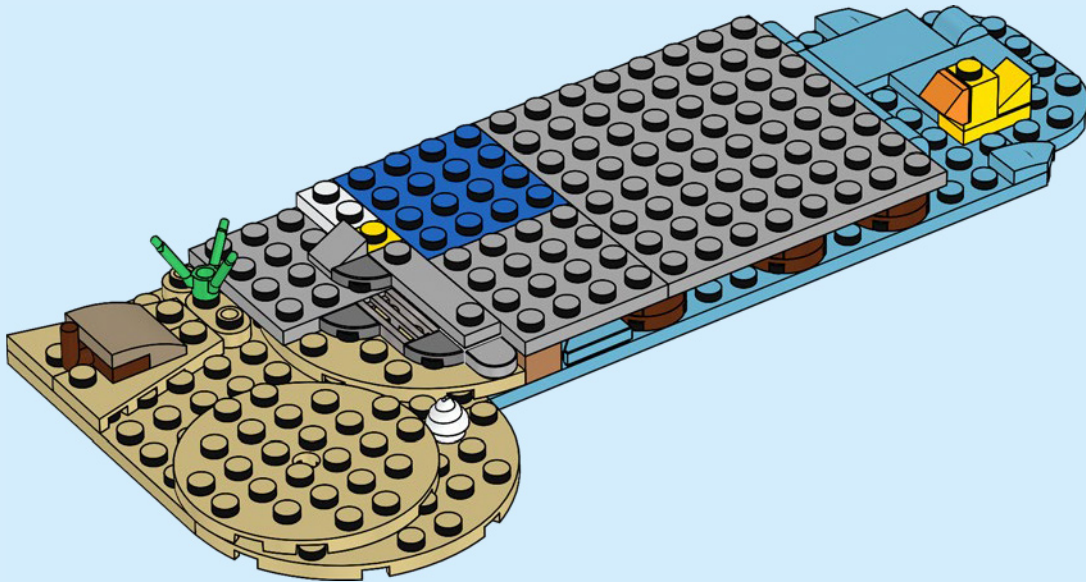

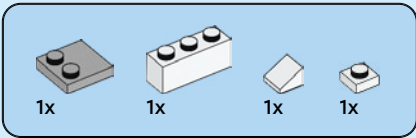

24

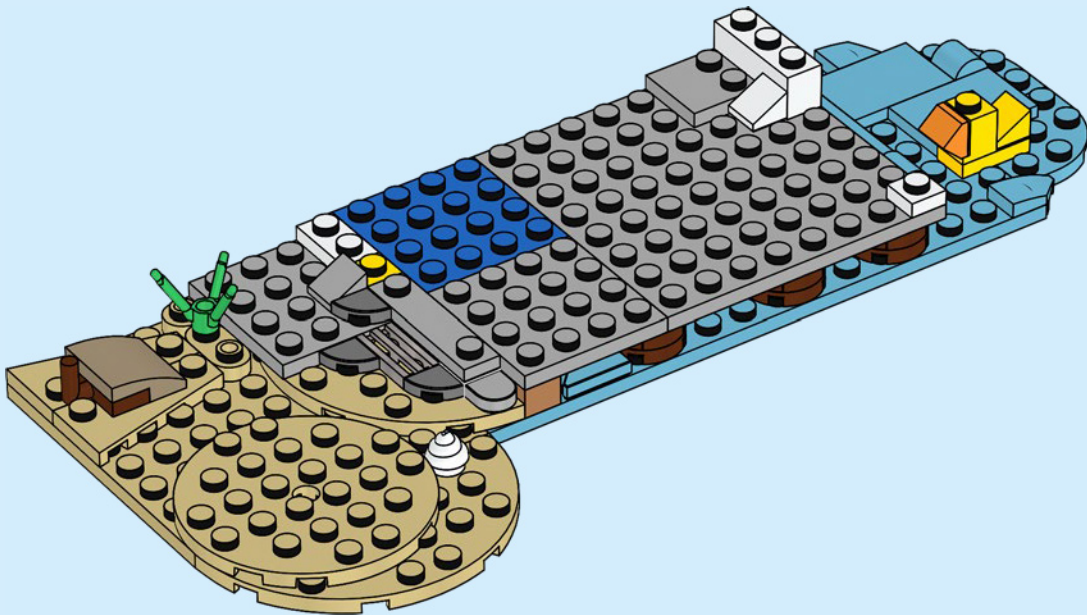



 1x	 1x	 2x
--	--	--

# 26

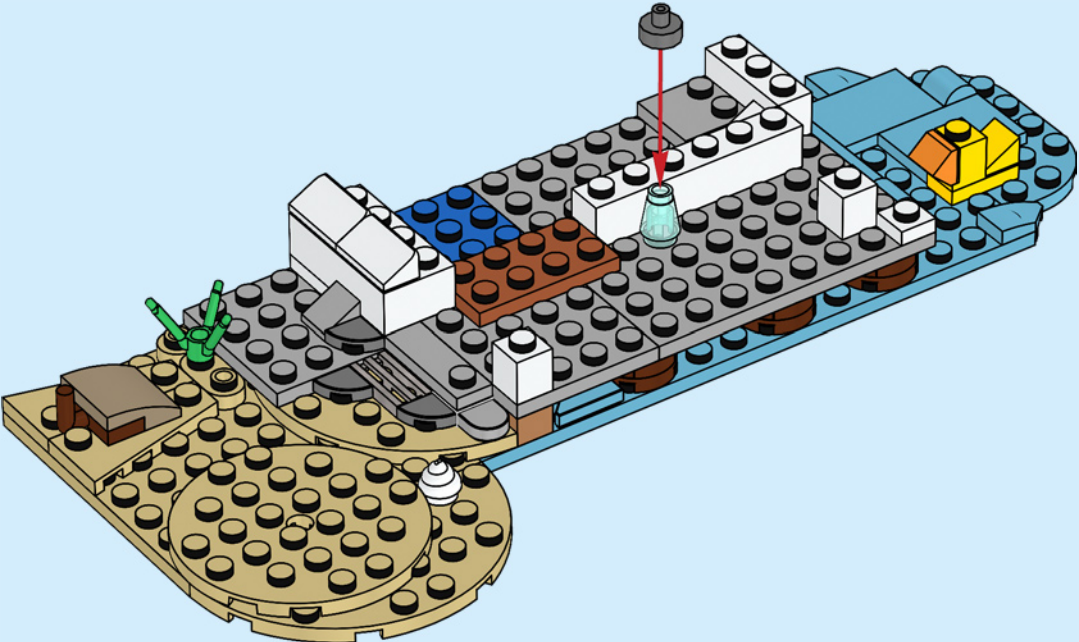

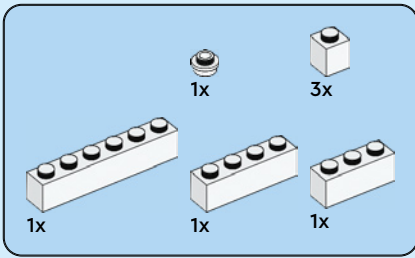

27

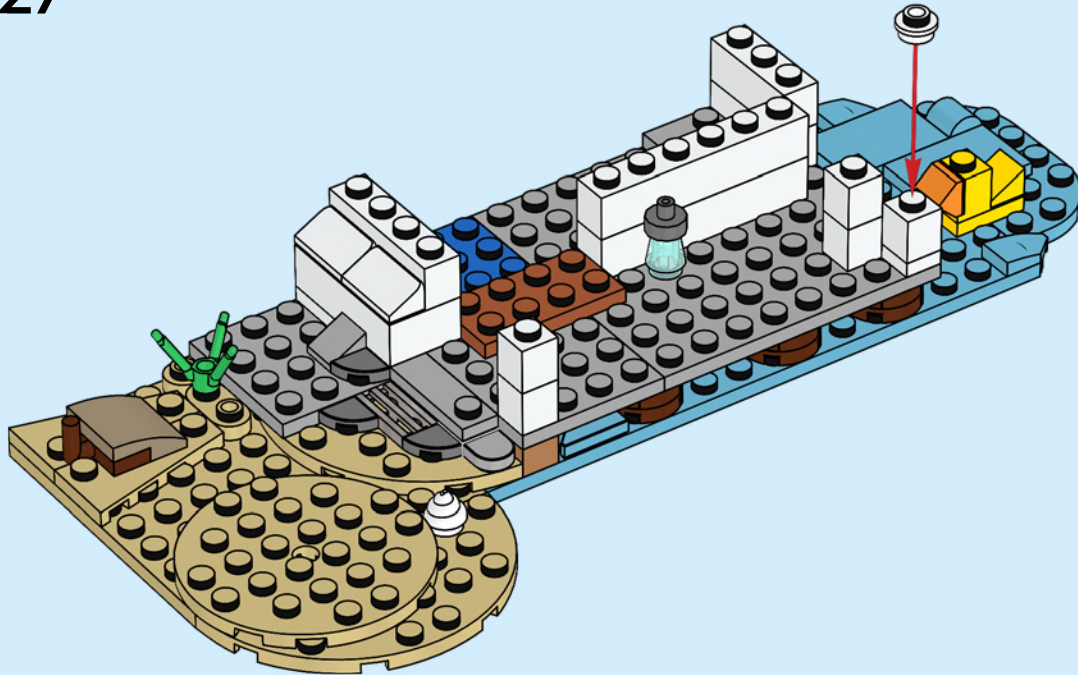



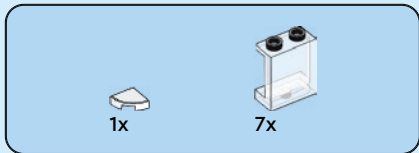

28

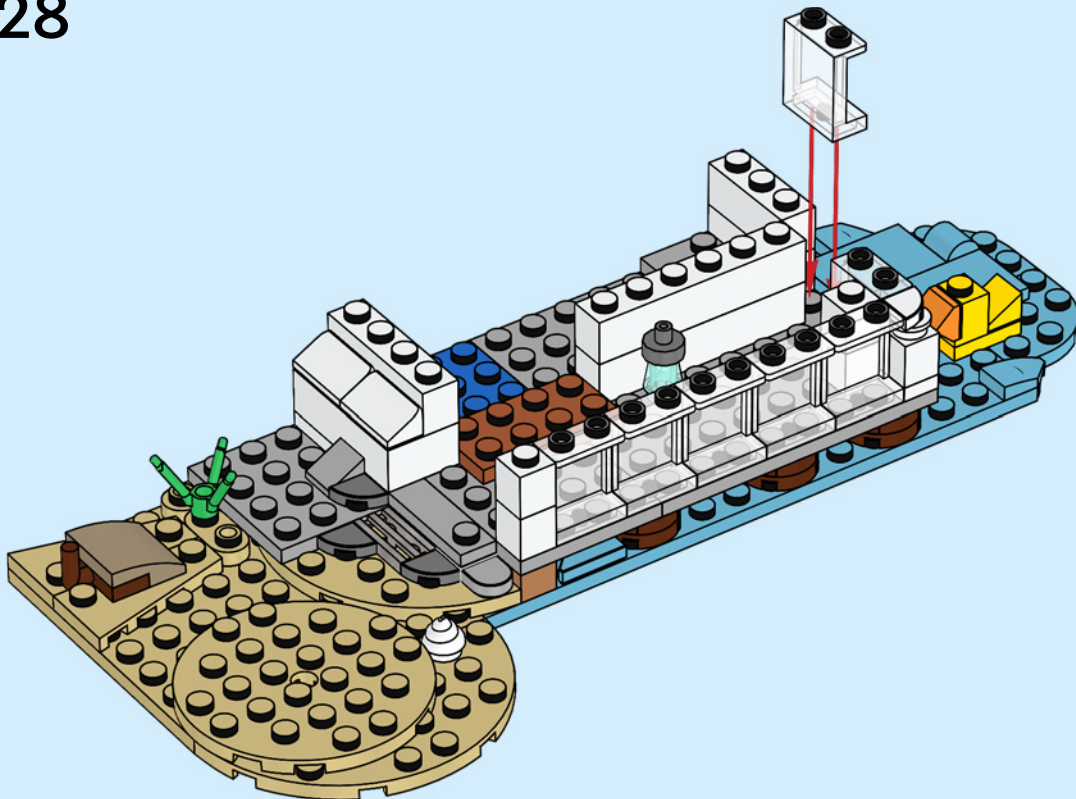



1x



1x

29

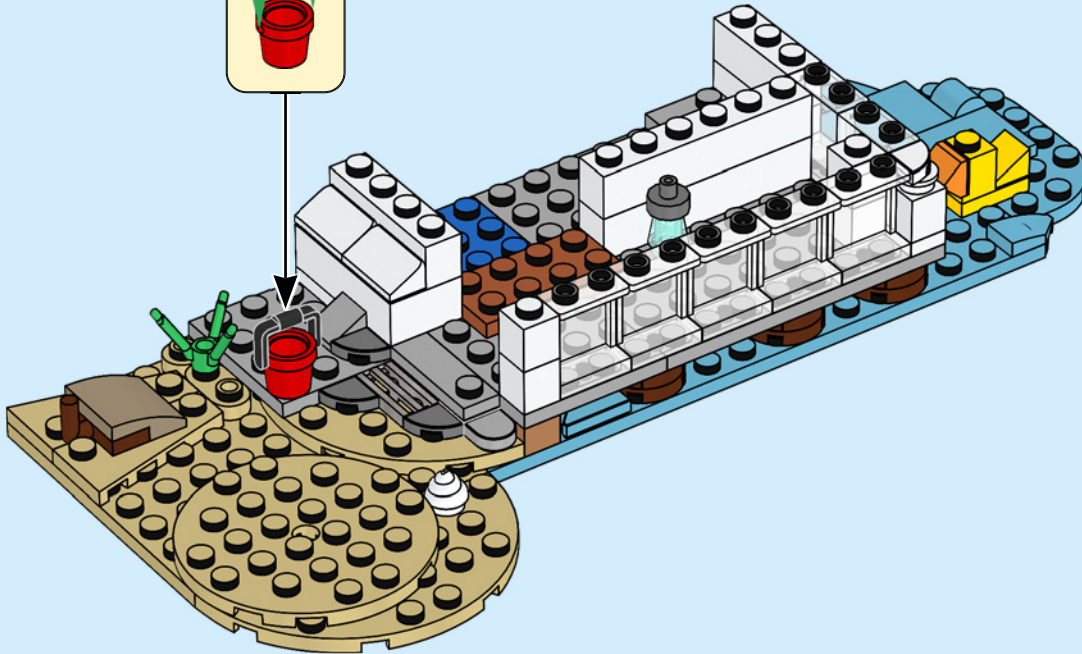
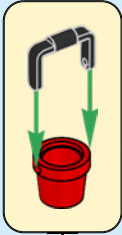



30

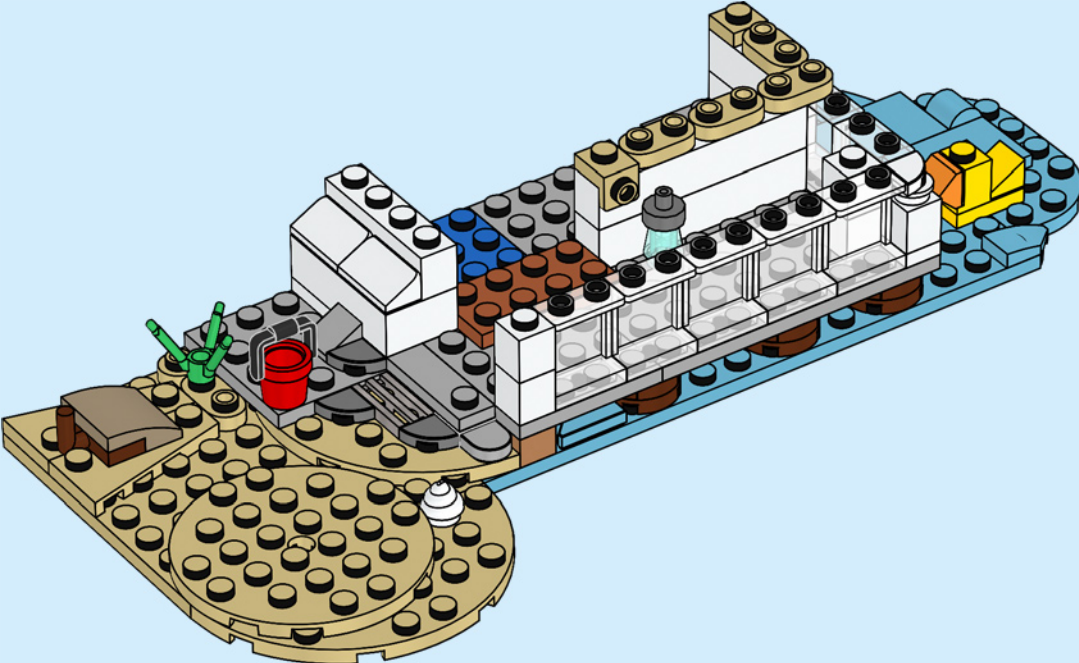

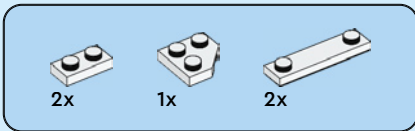

31

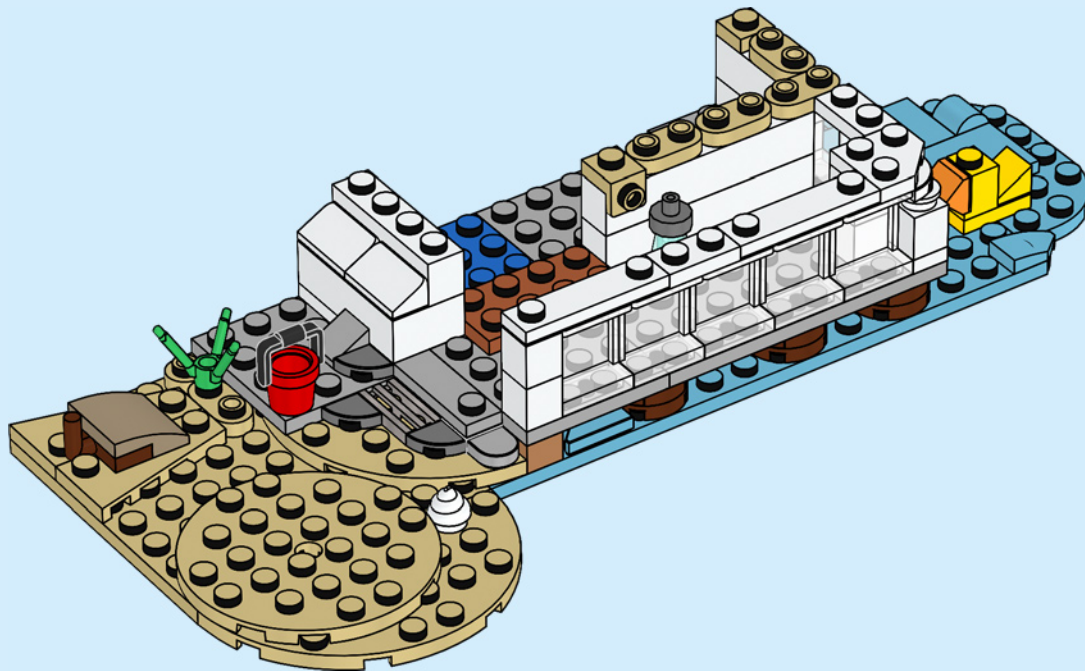

2x 1x 1x

32

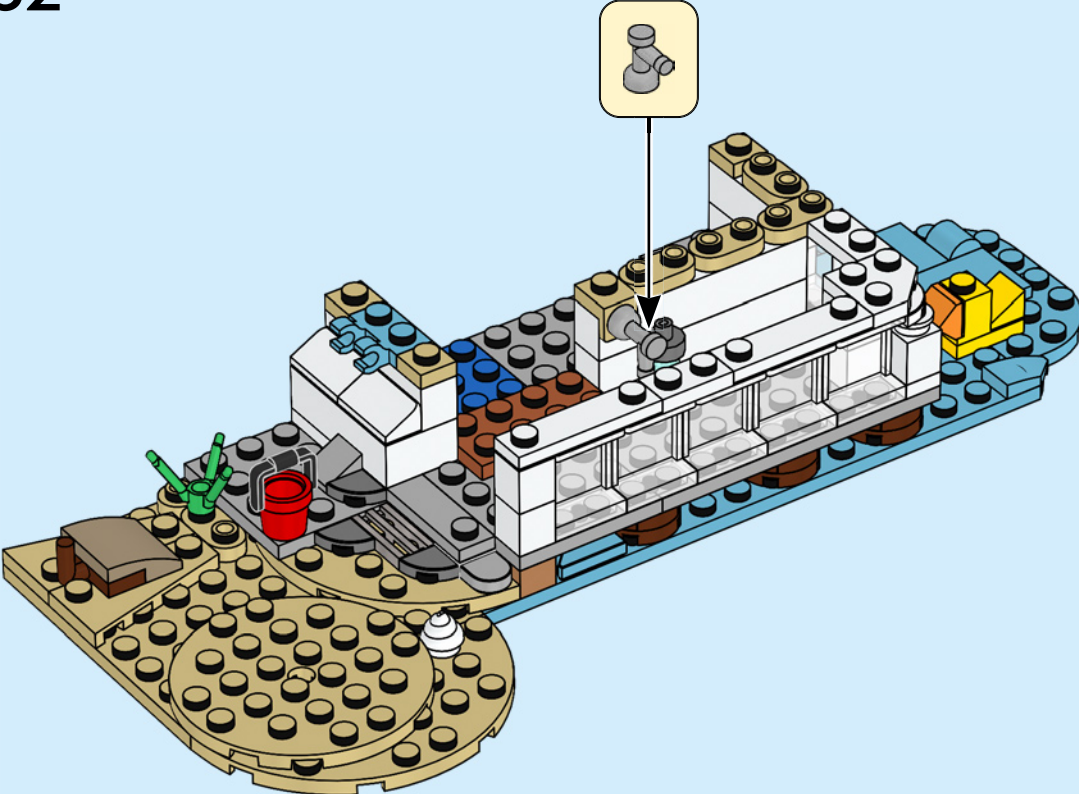

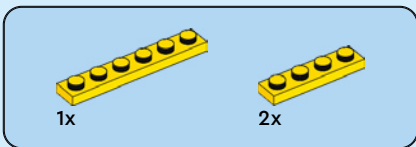

33

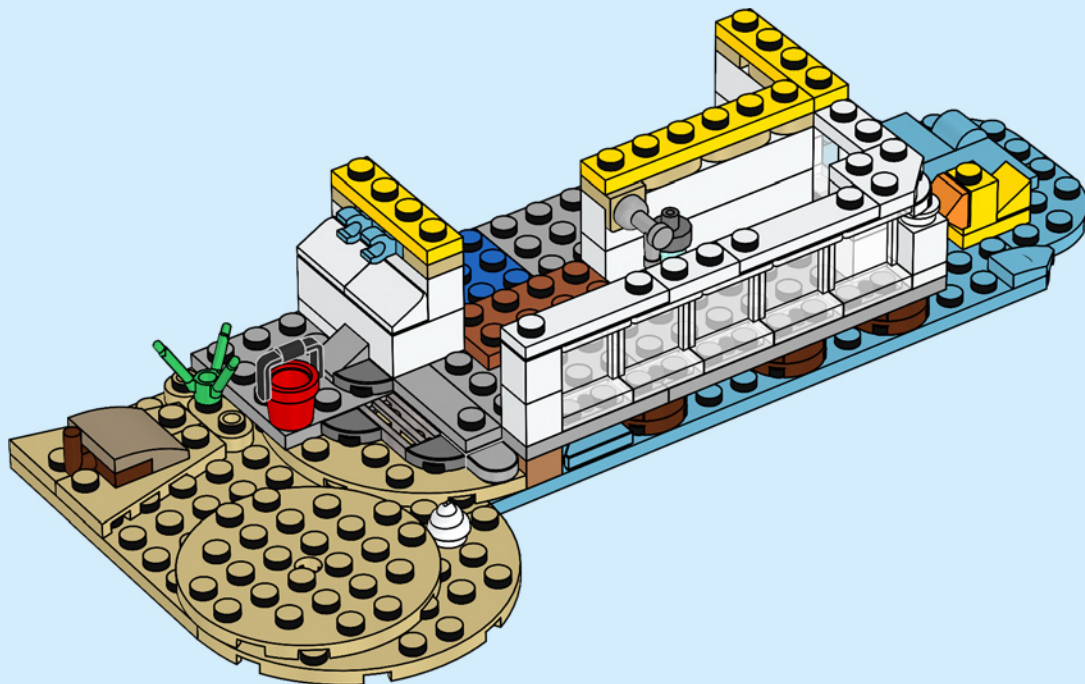



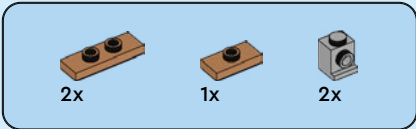

34

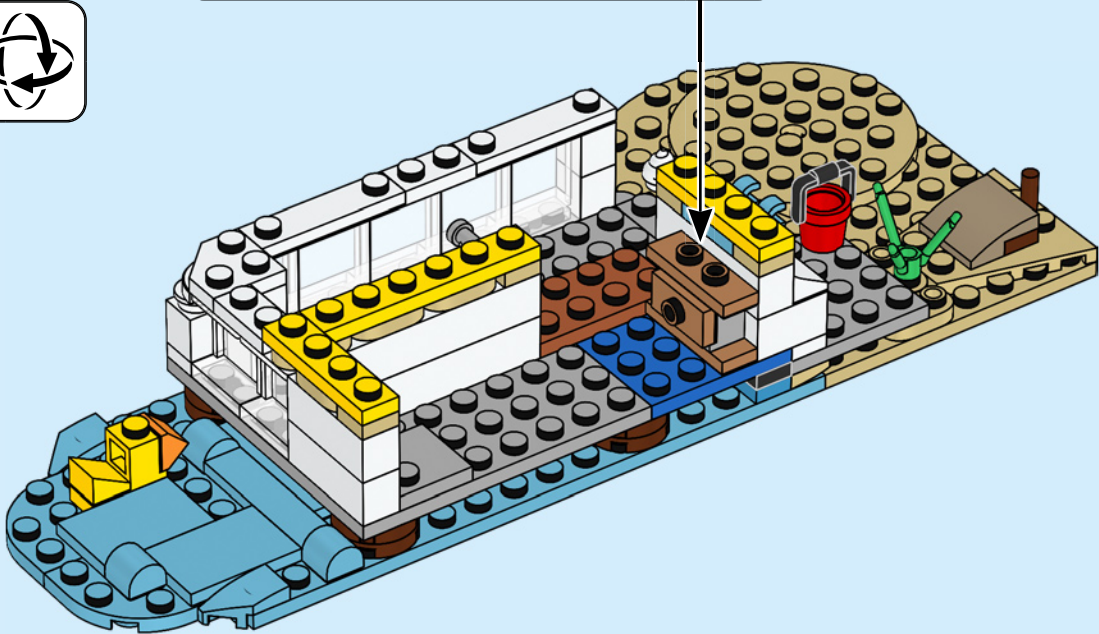
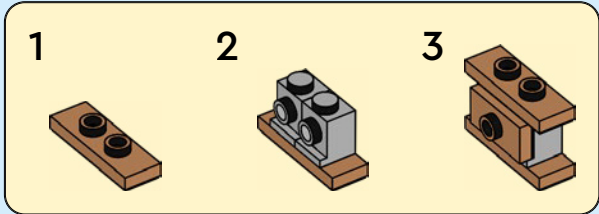



1x



1x



1x

# 35

1



2

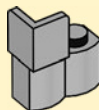

3

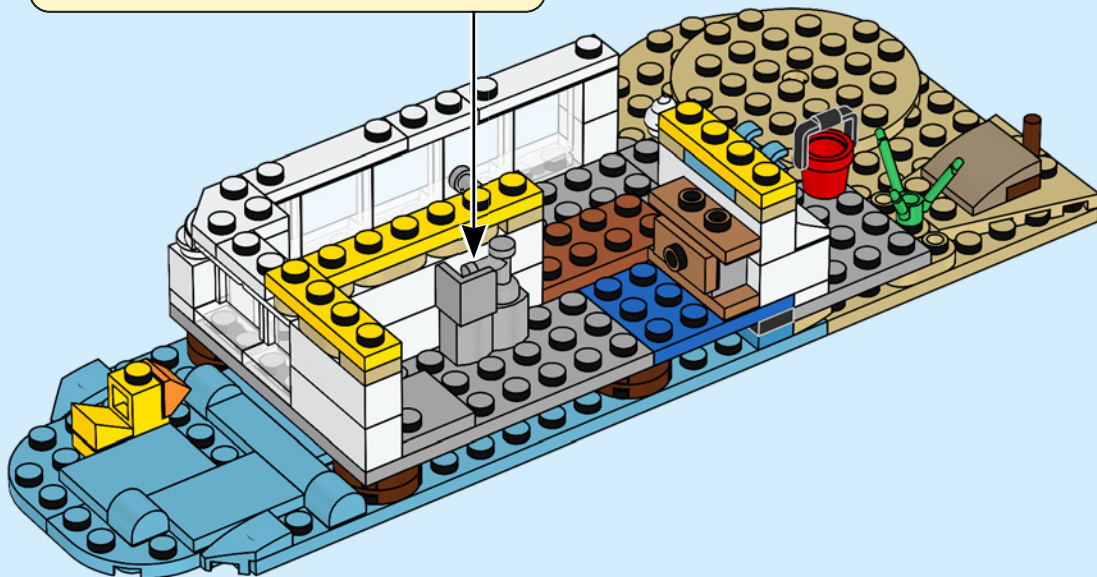

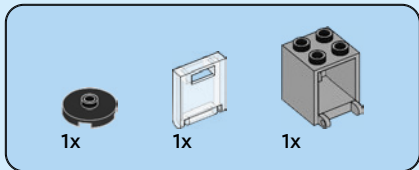

36

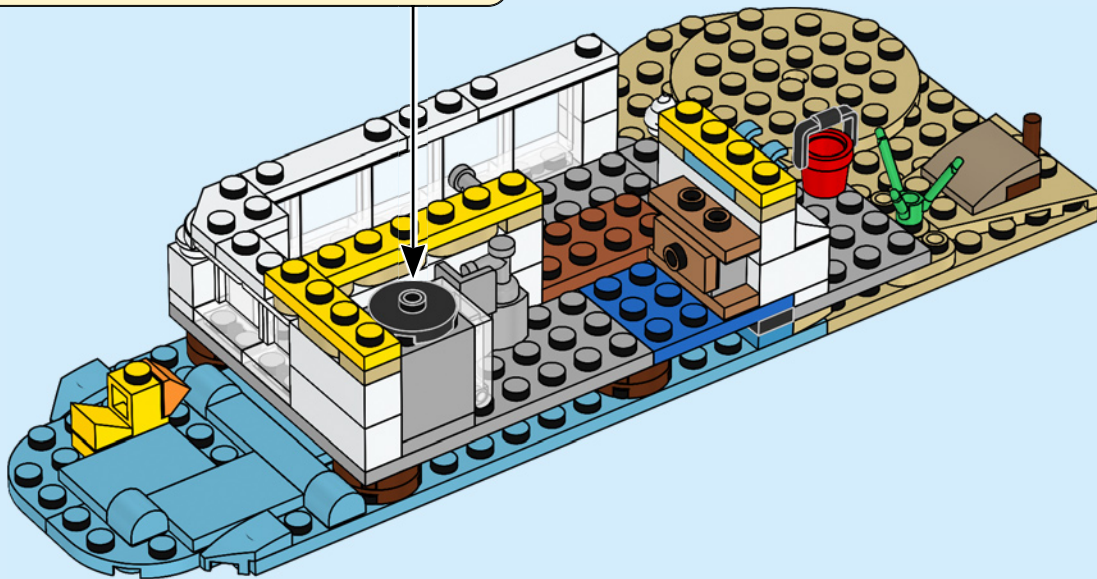
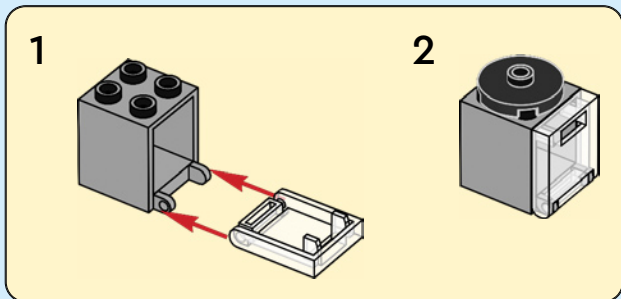







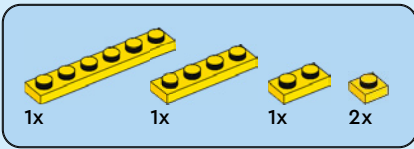

39

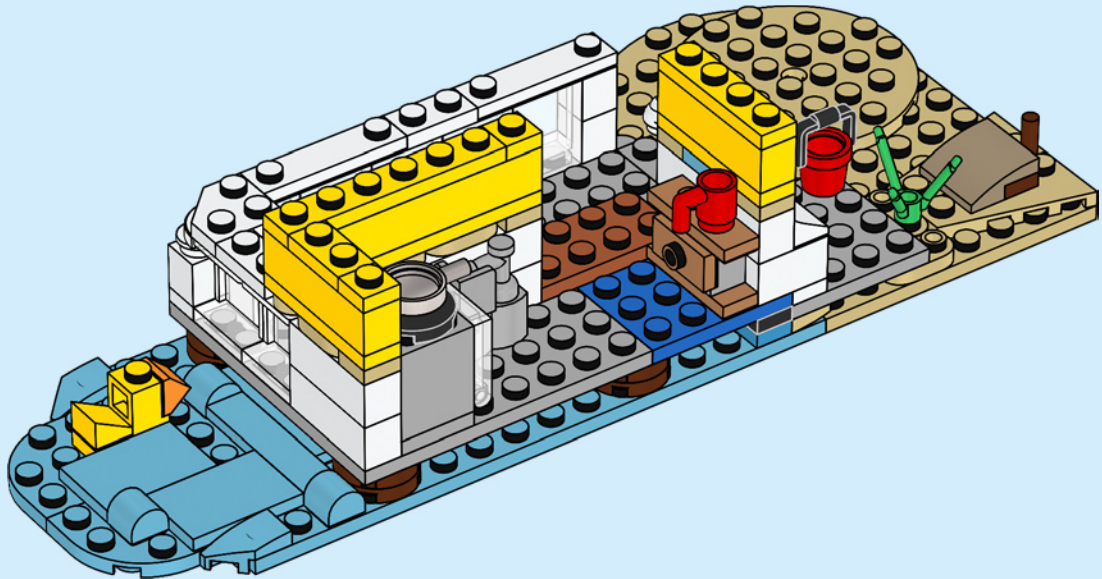



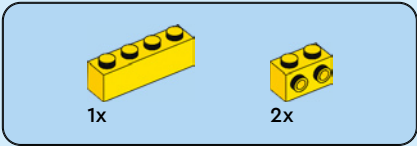

40

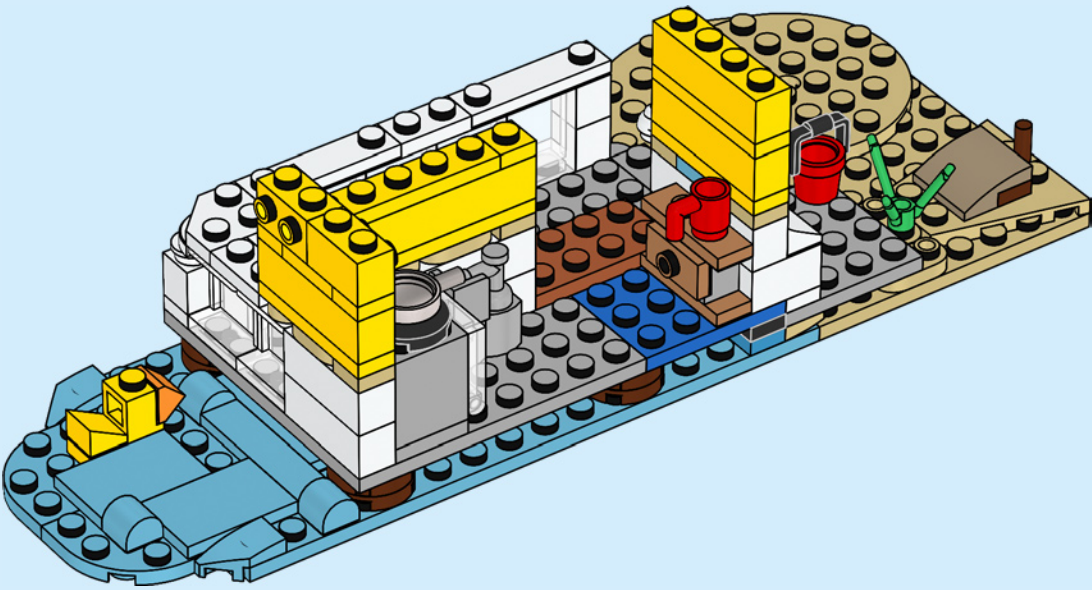



41

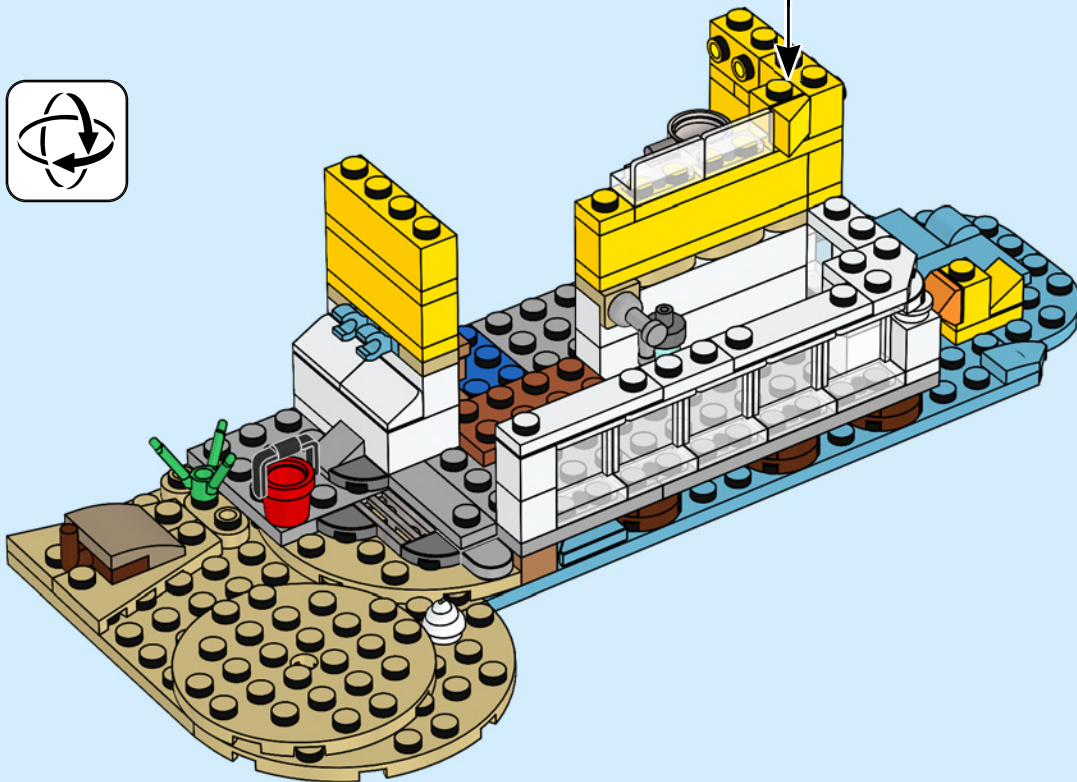
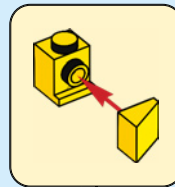

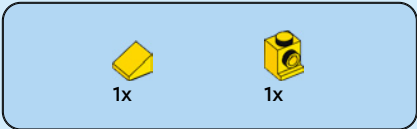

42

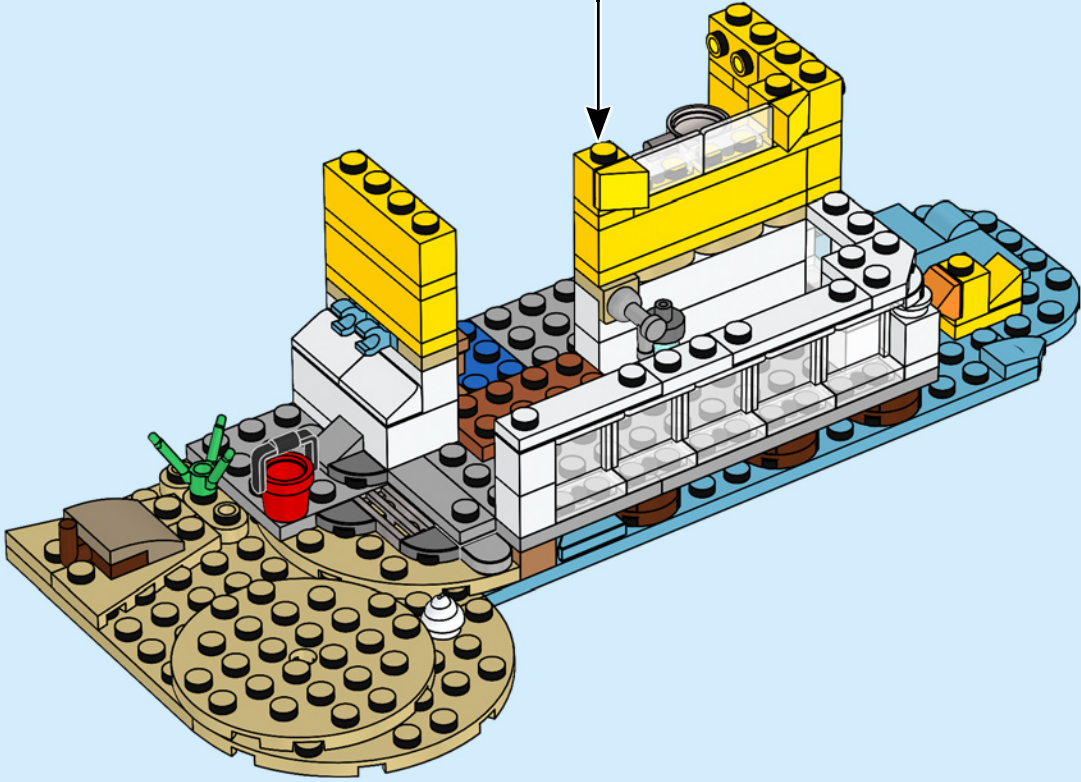
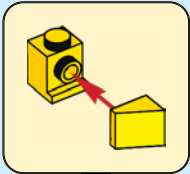

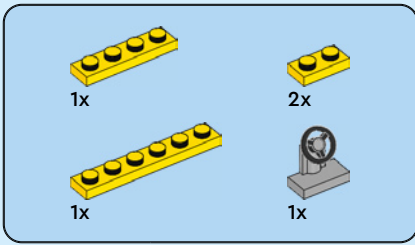

43

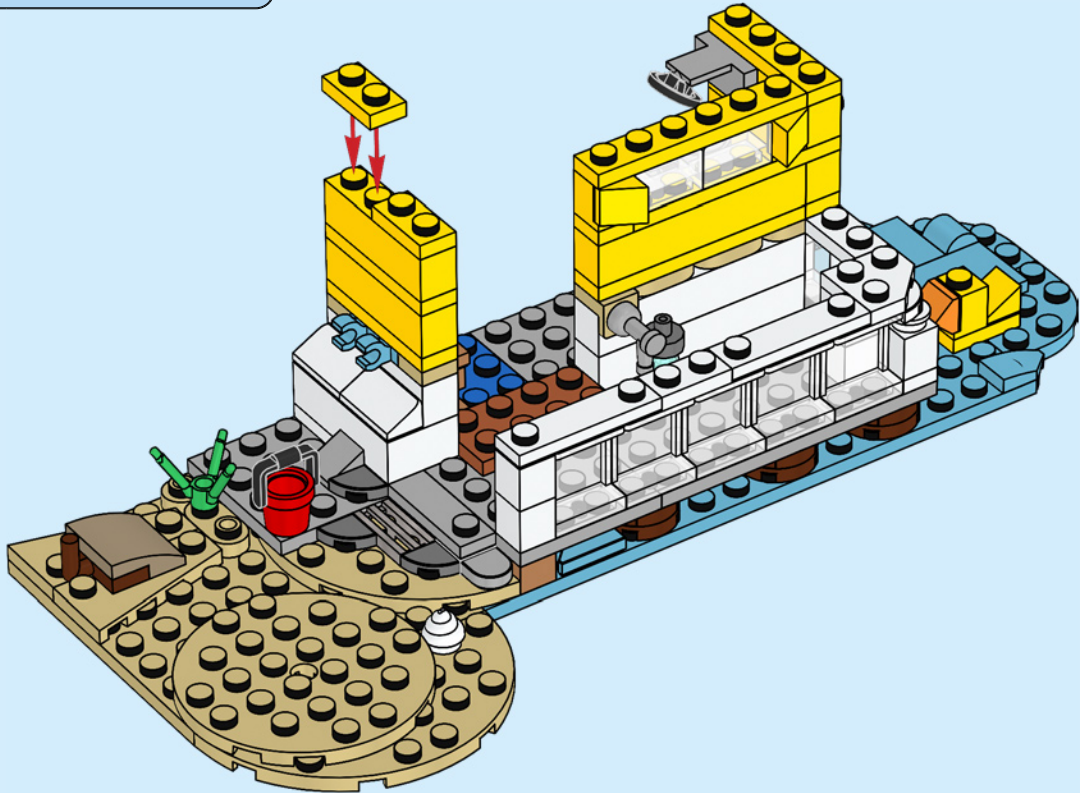

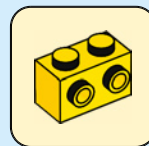
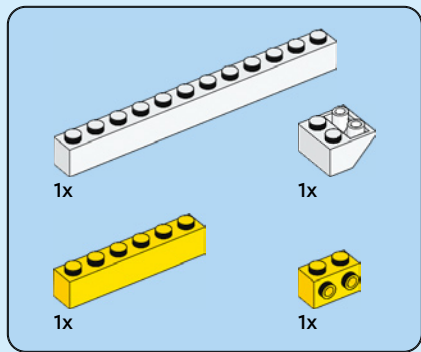

44

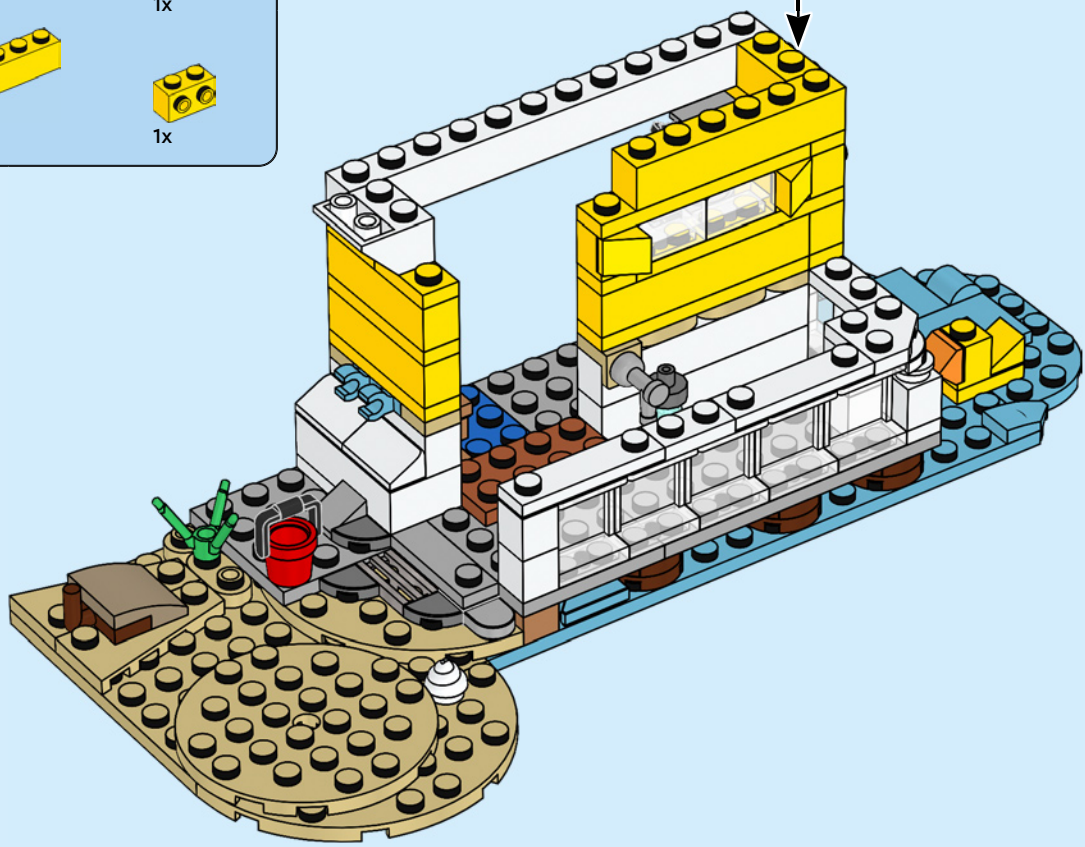





1x



1x

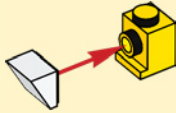

45

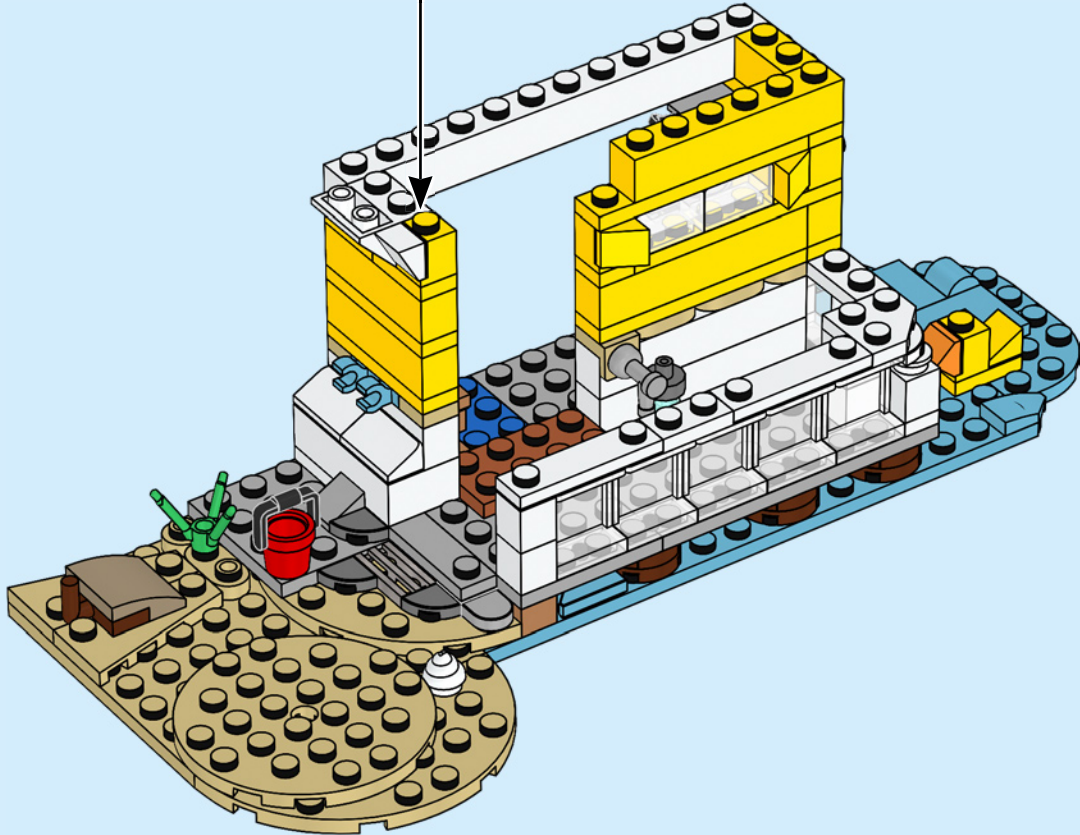



2x



1x

46

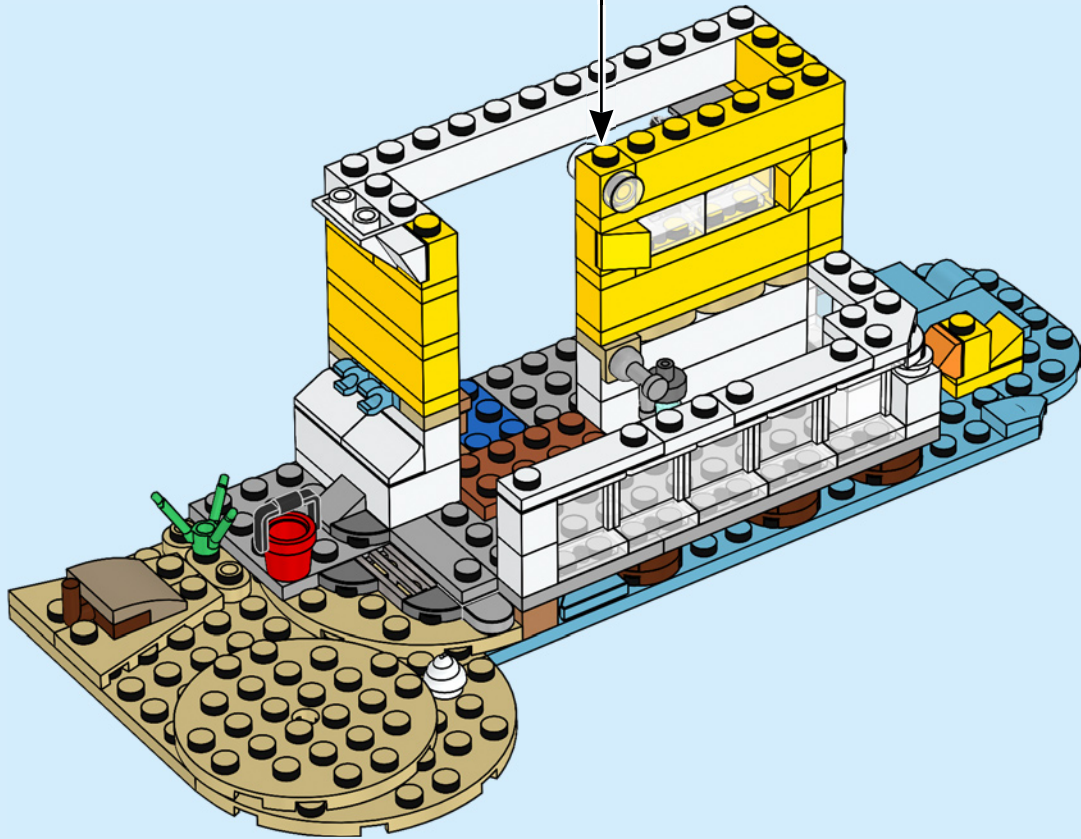
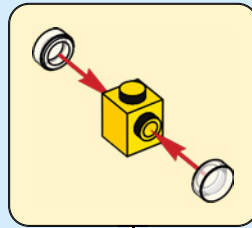

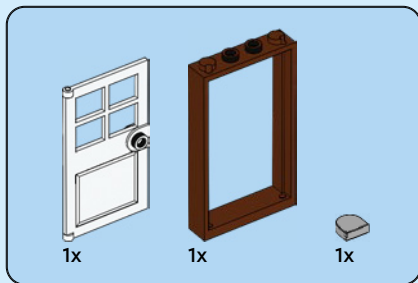

47

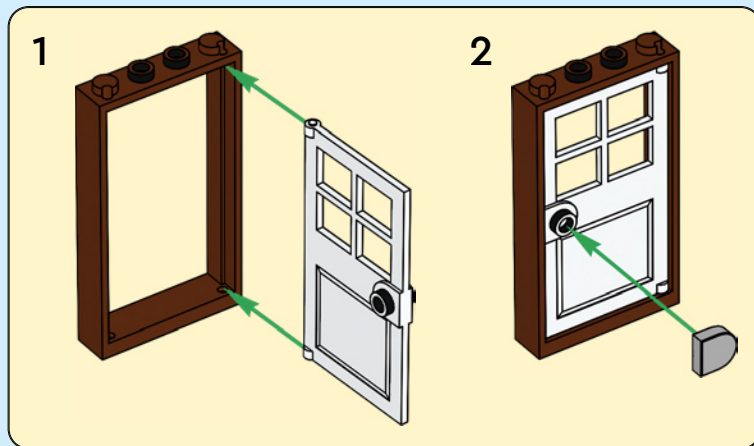

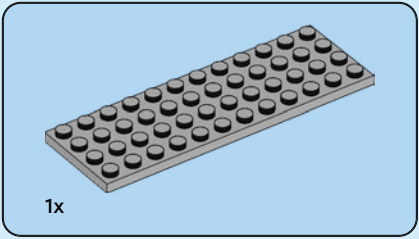

48





49

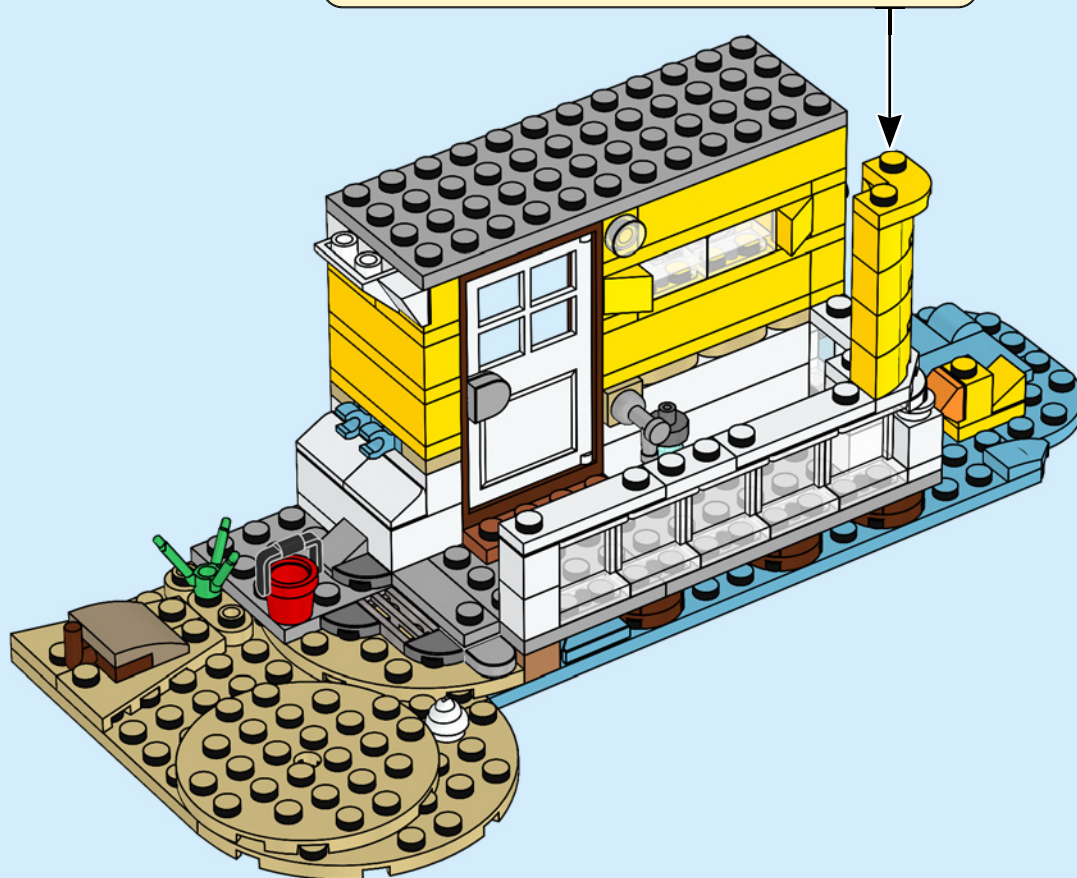
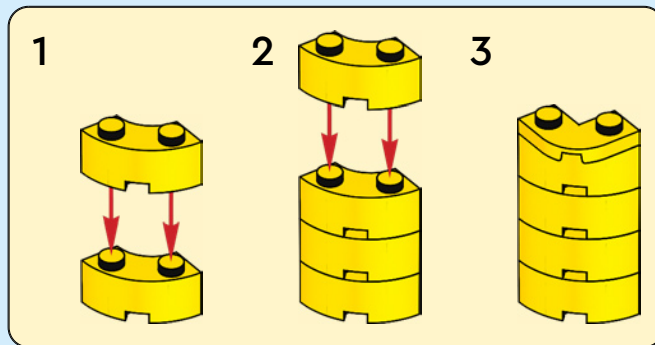



# 50

1



2



3



4



5





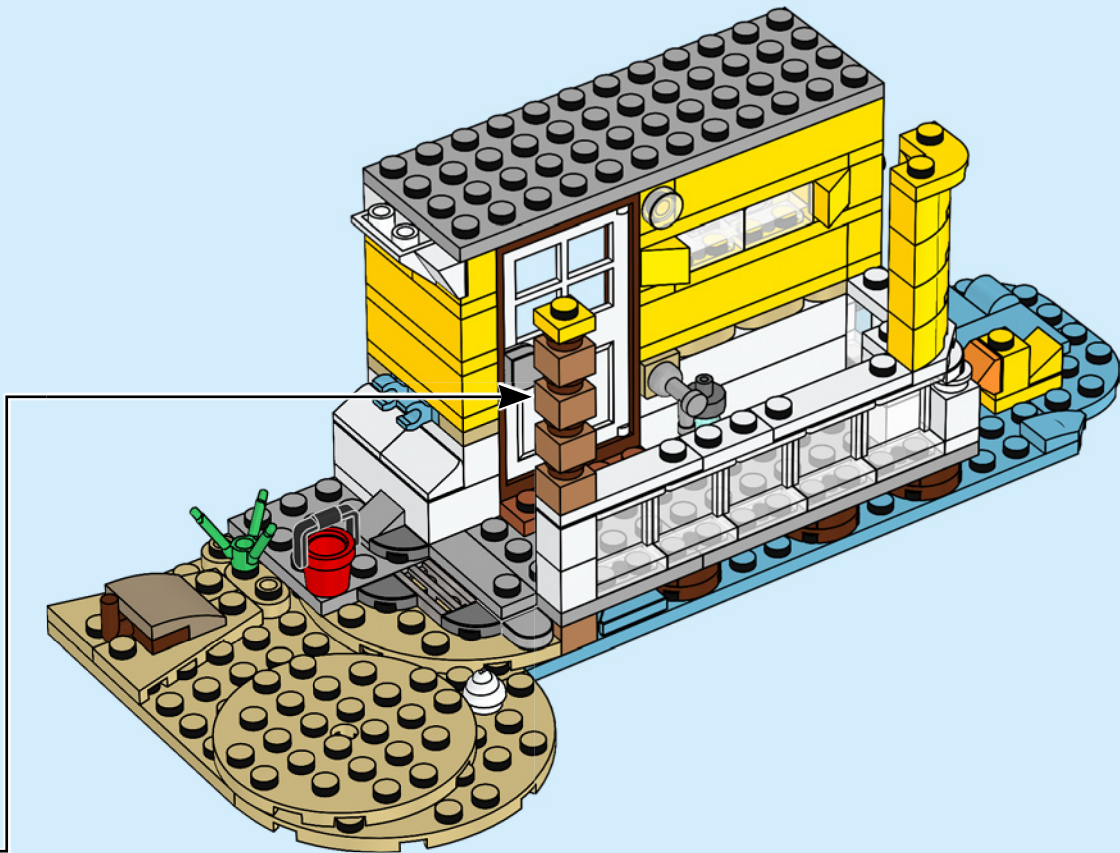





1x



1x

51

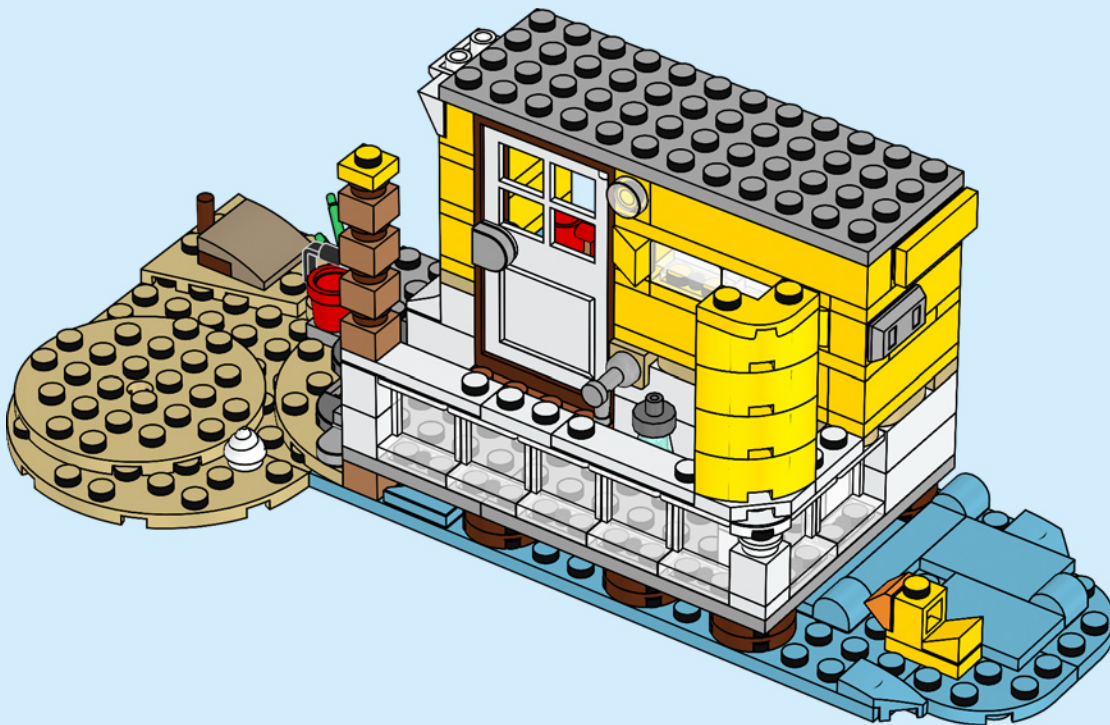

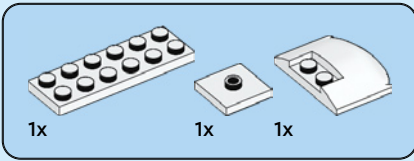

52

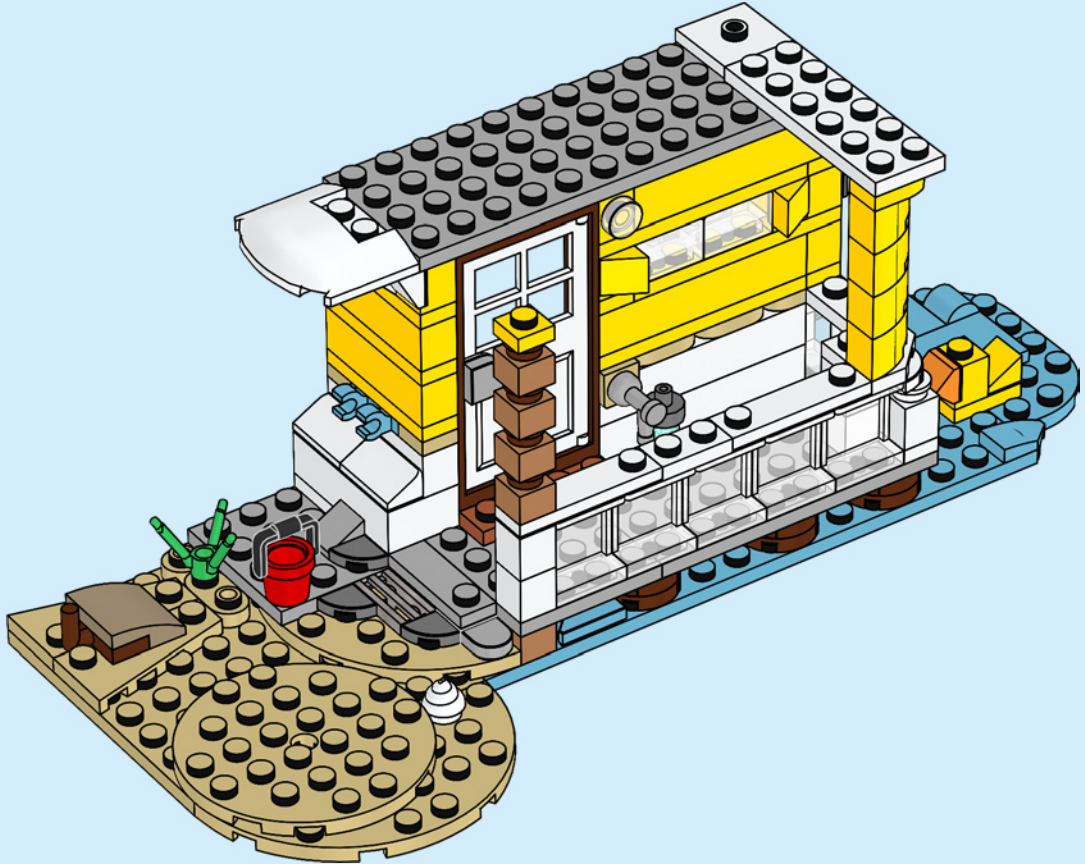

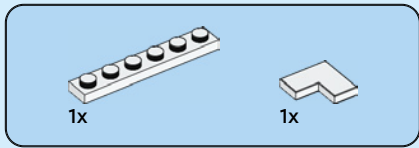

53

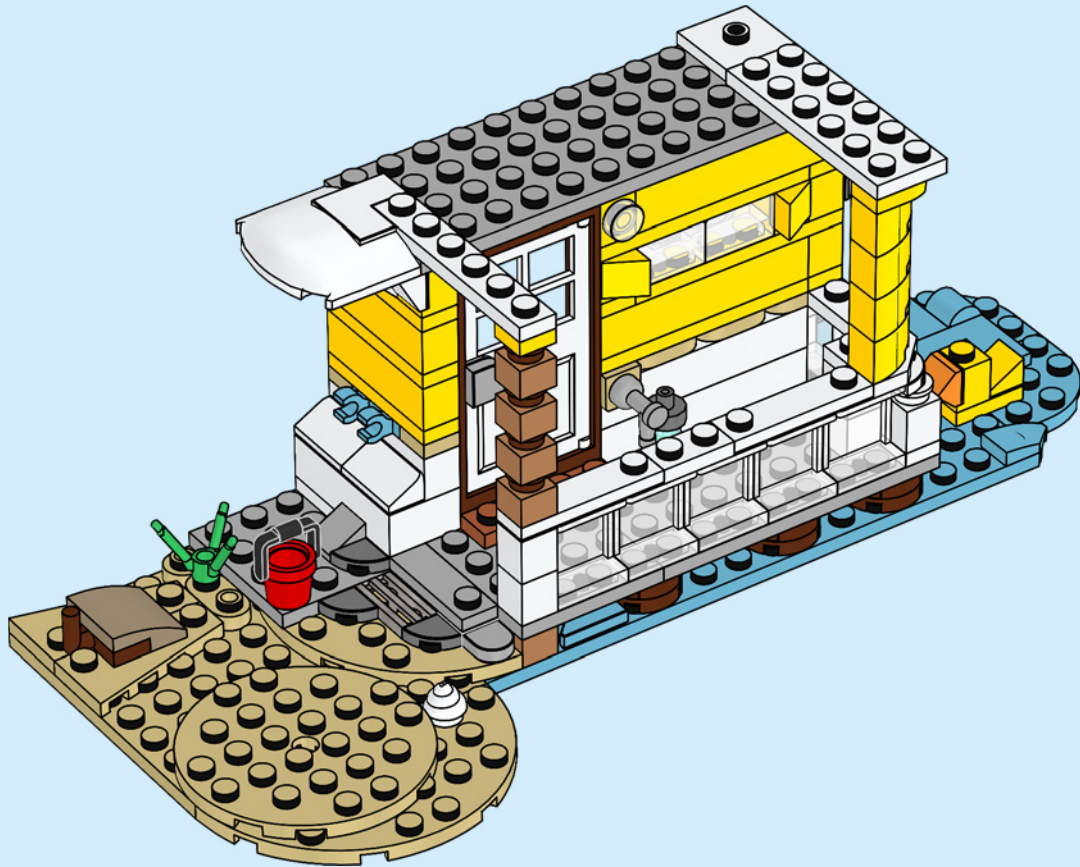

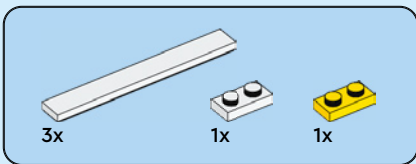

54

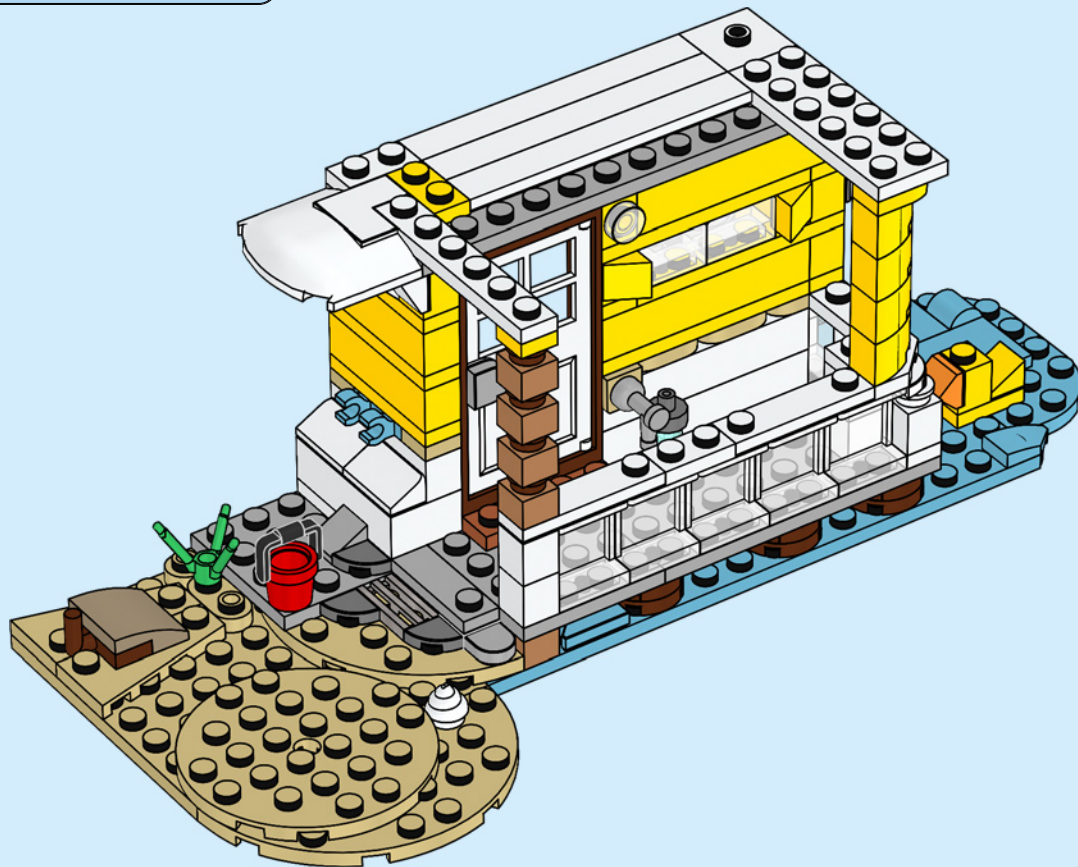





3x

55

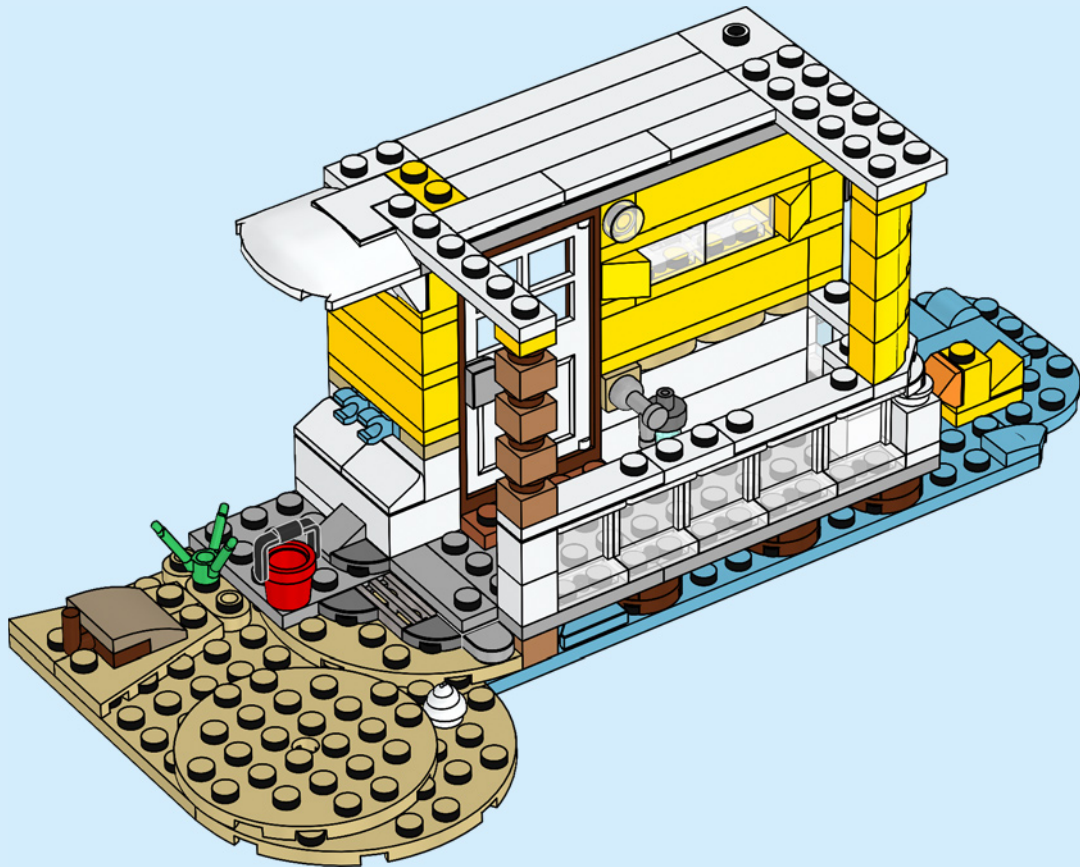





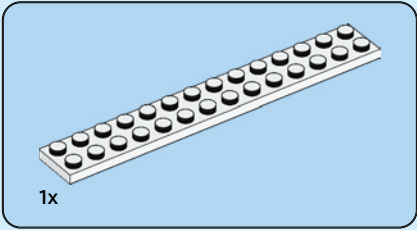
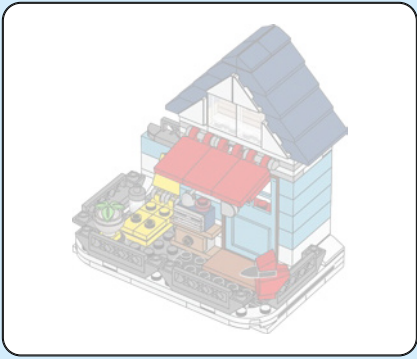

1

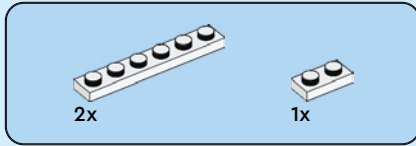
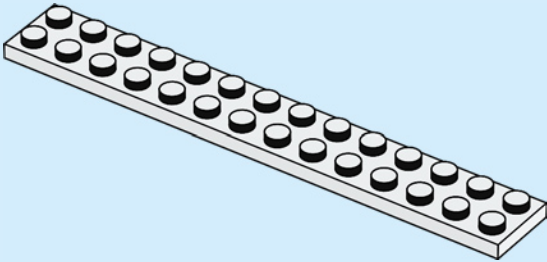

2

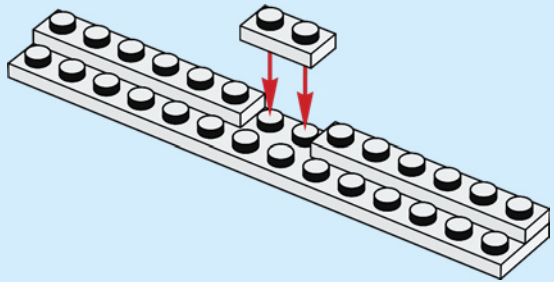

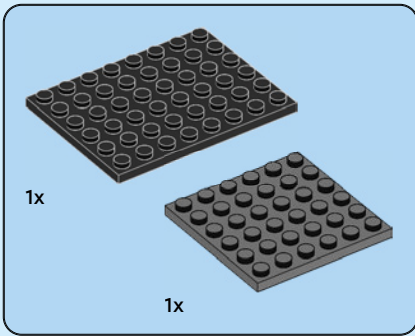

3

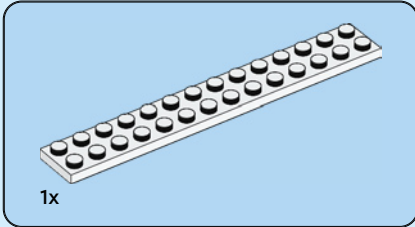
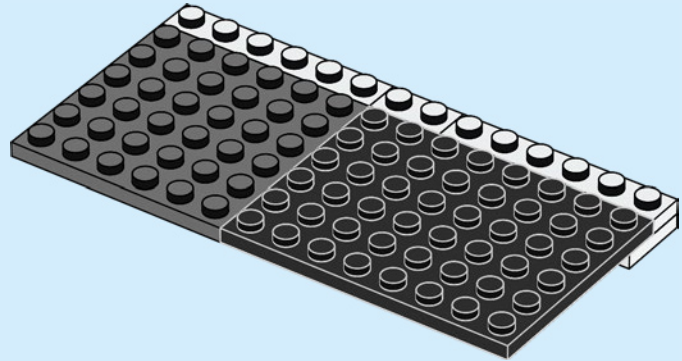

4

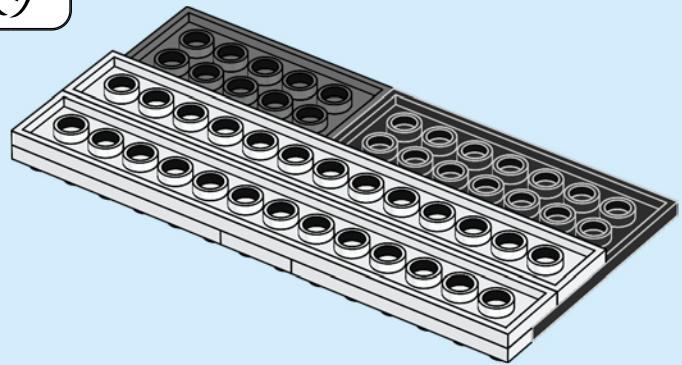
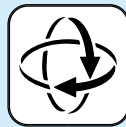



2x

5

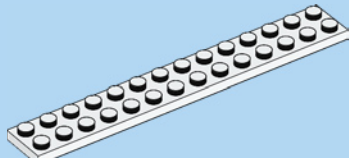
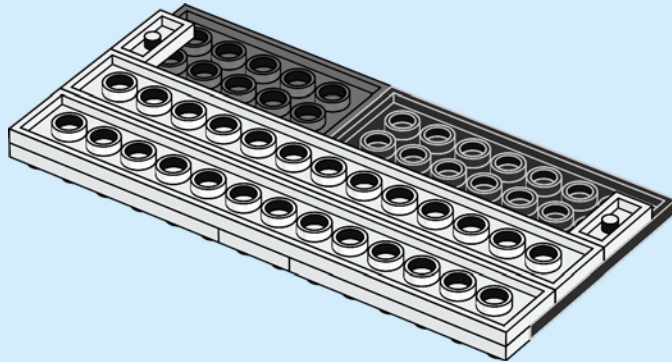

1x

6

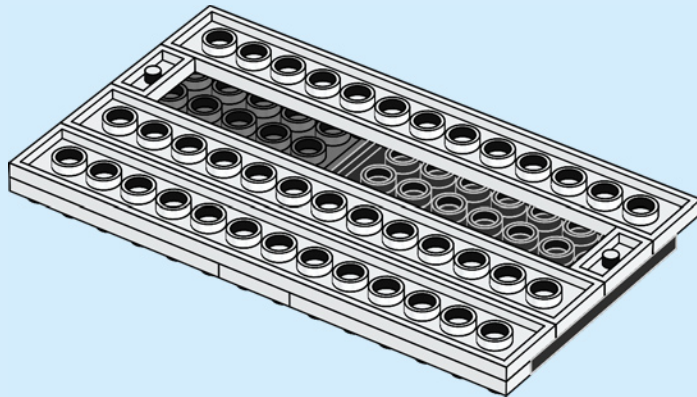

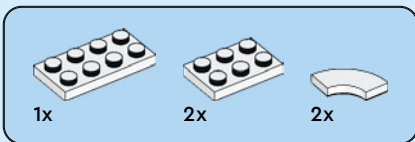

7

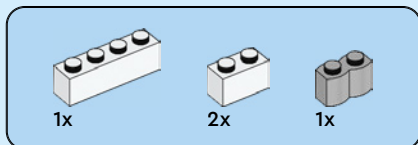
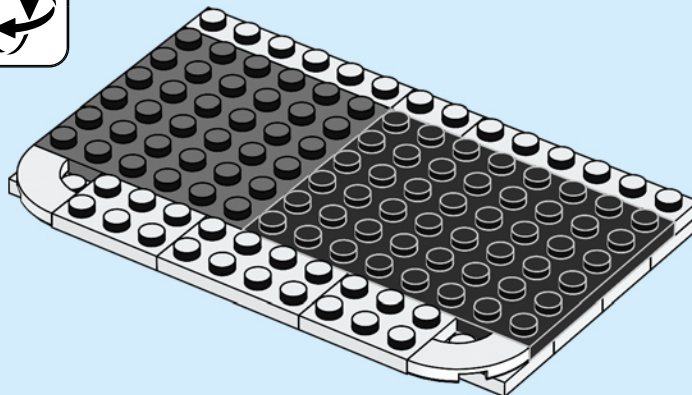

8

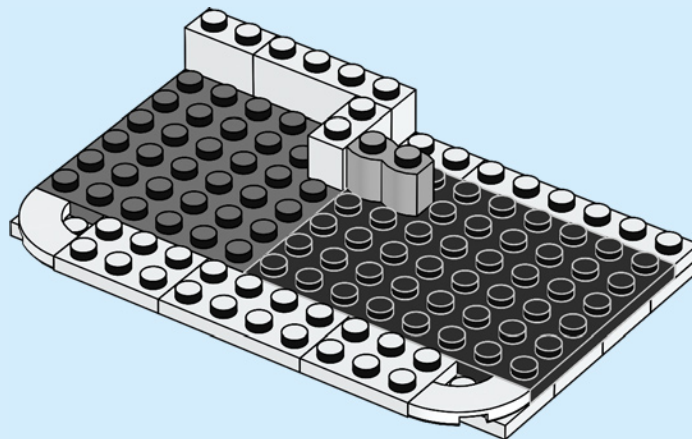





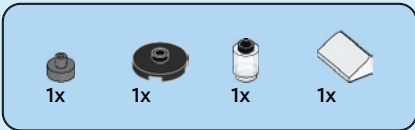

11

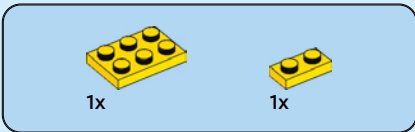
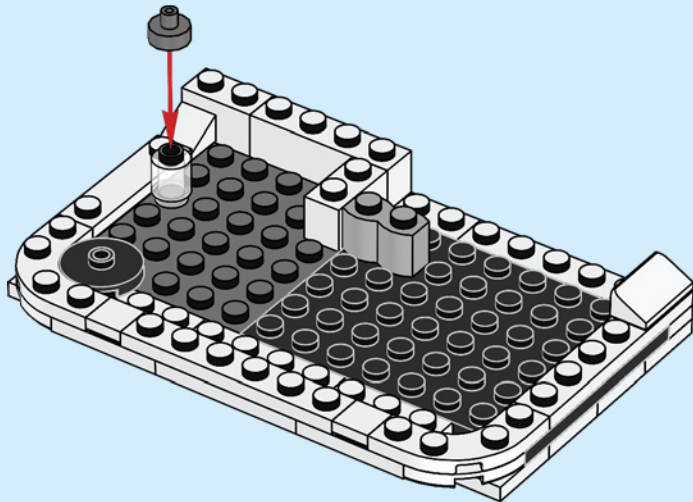

12

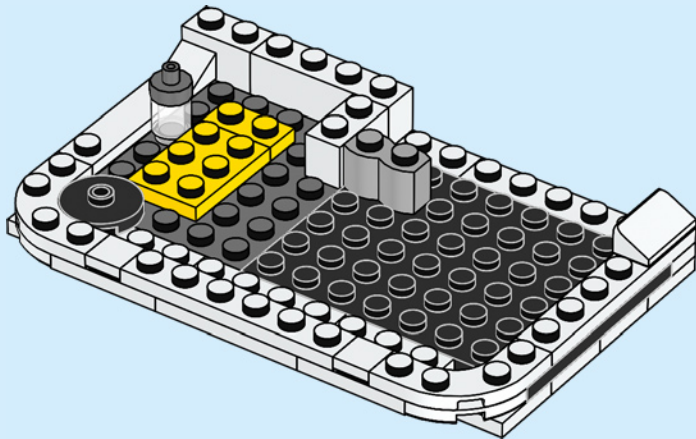

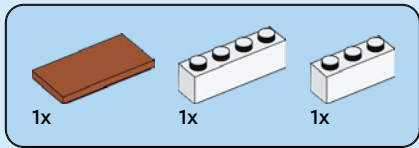

13

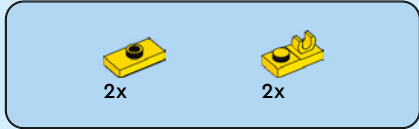
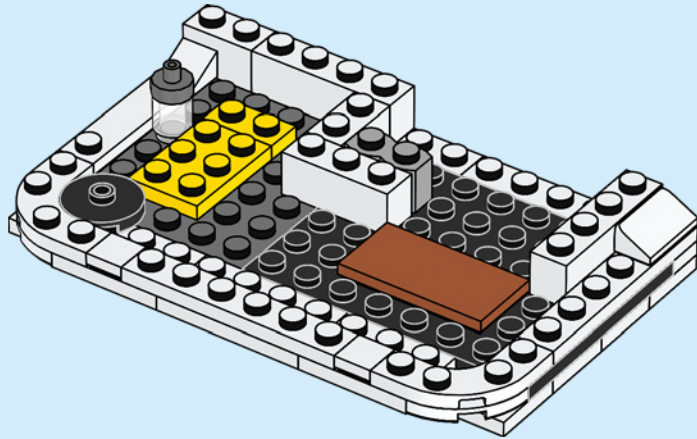

14

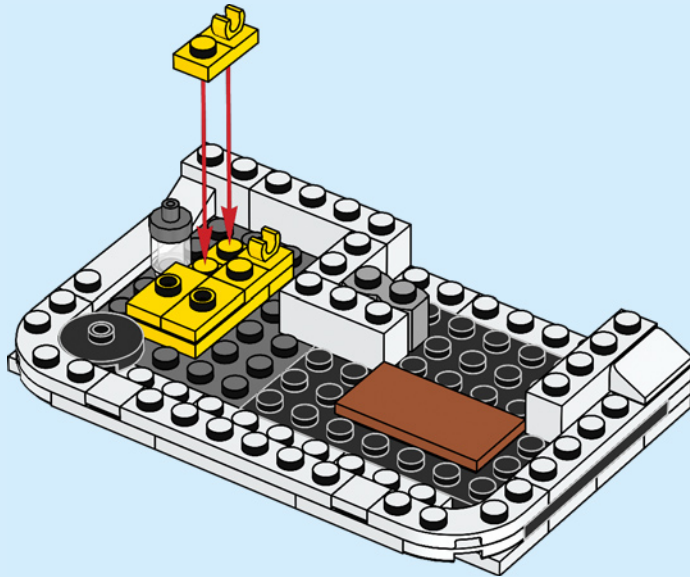

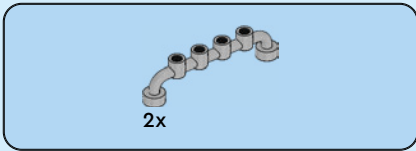

15

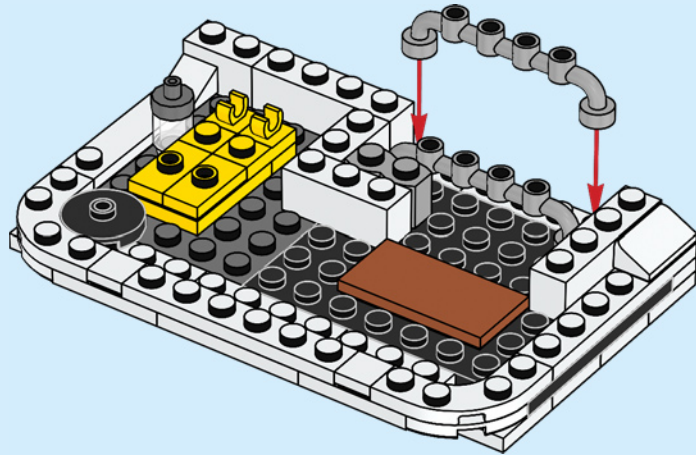

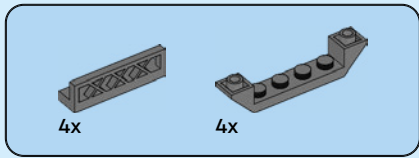

16

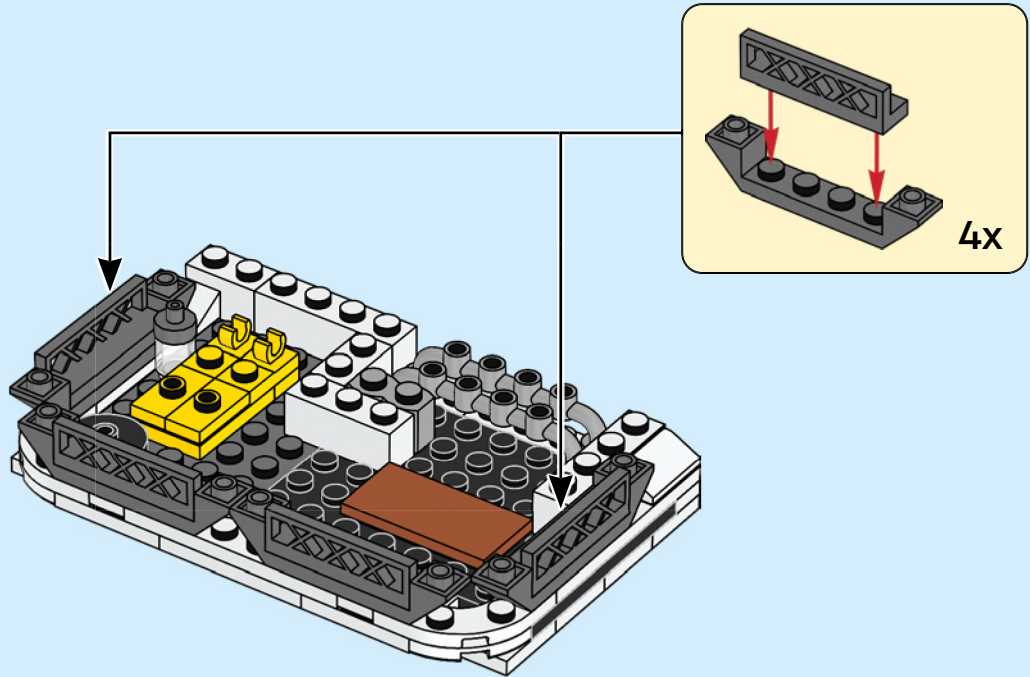



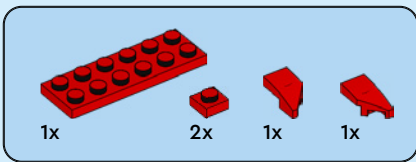

17

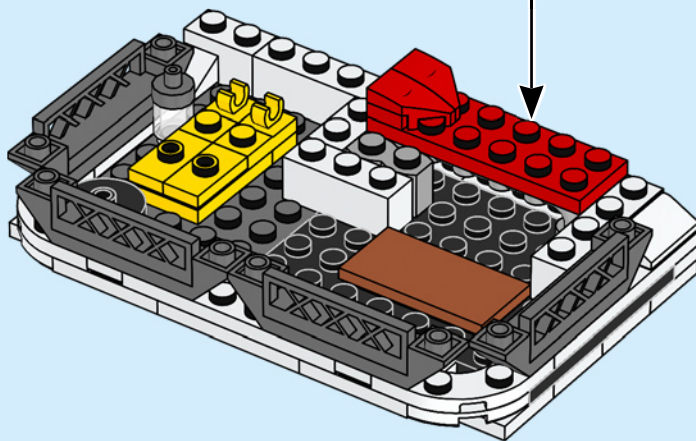
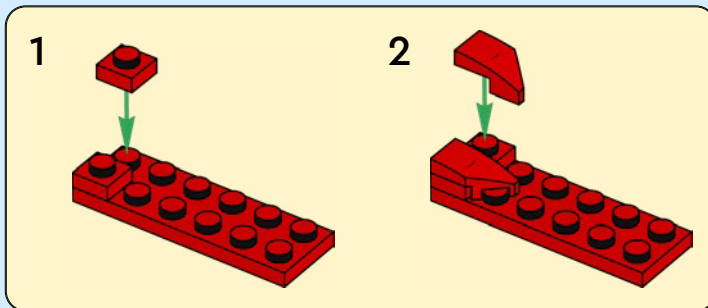

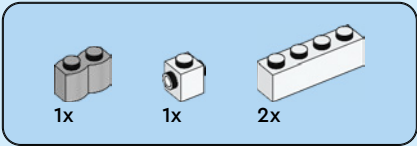

18

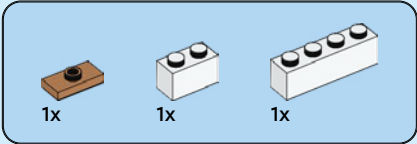
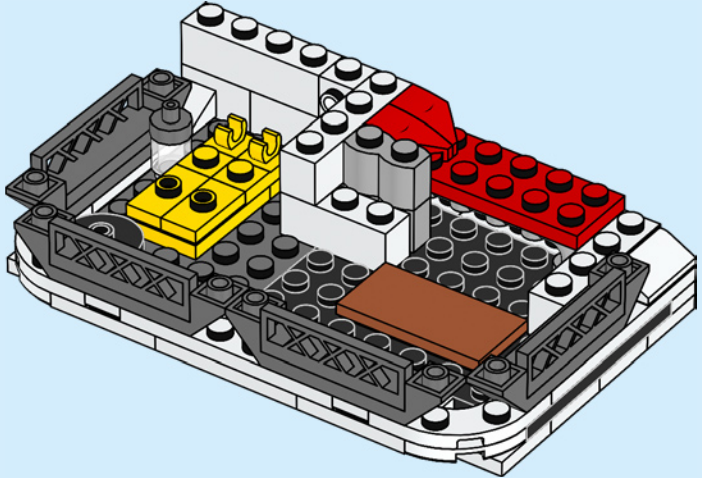

19

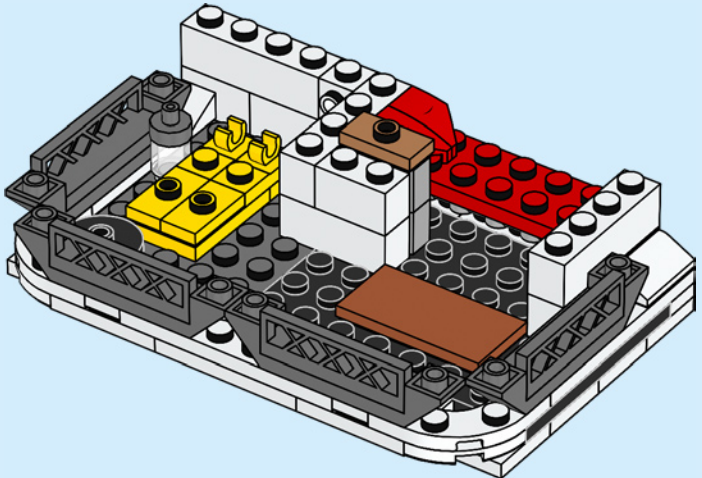

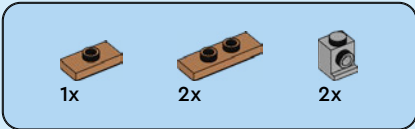

20

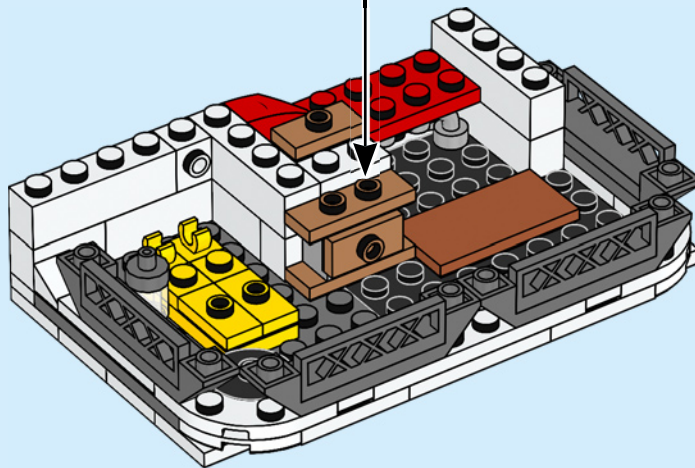
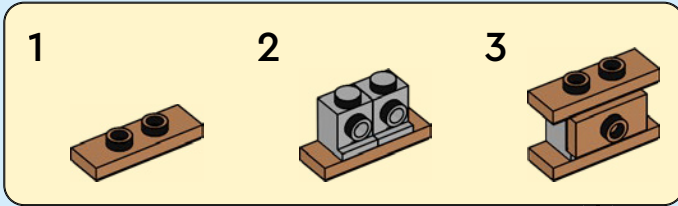

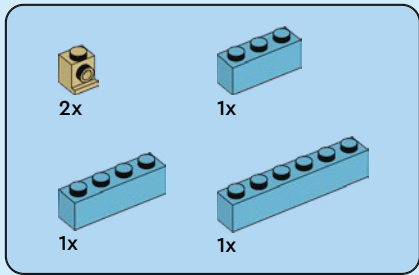

21

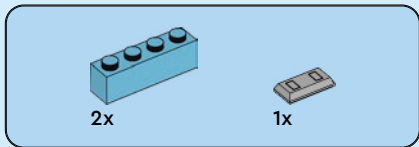
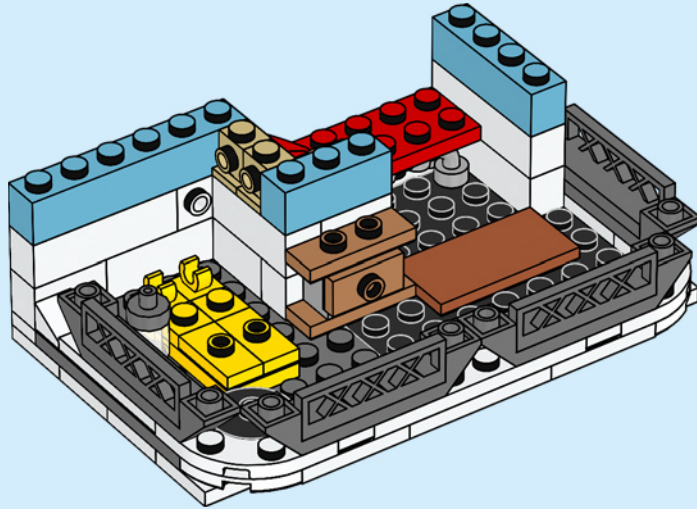

22

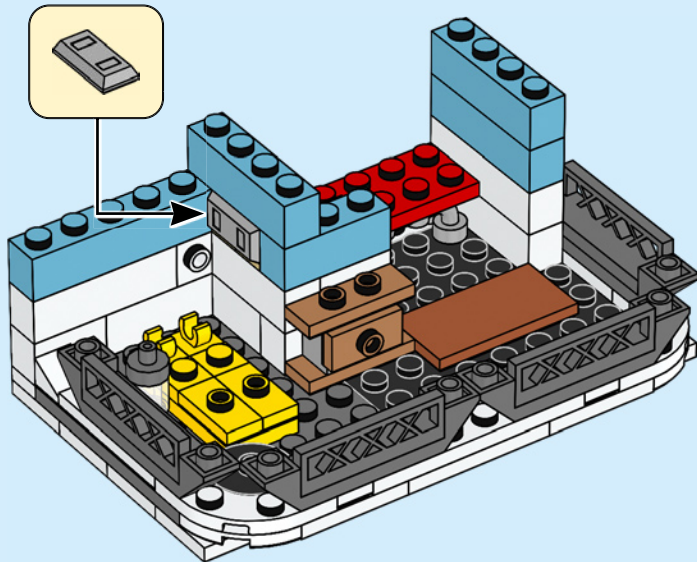

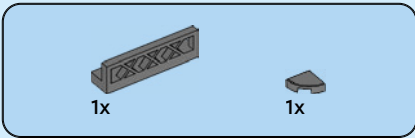

23

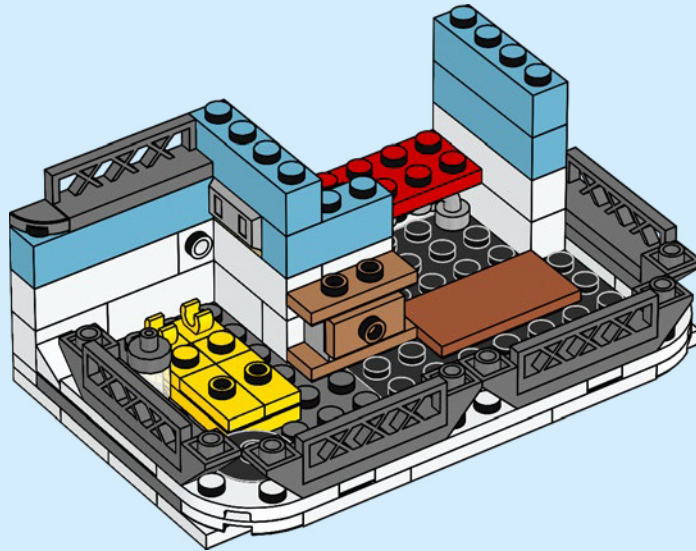



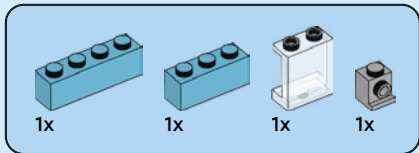

24

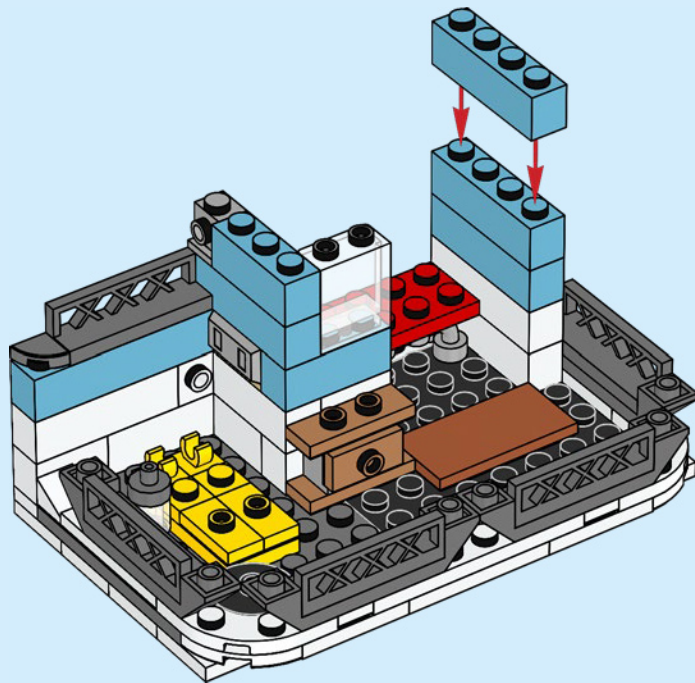

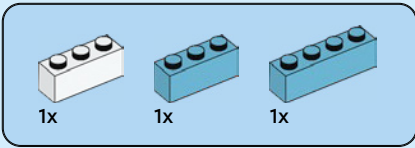

25

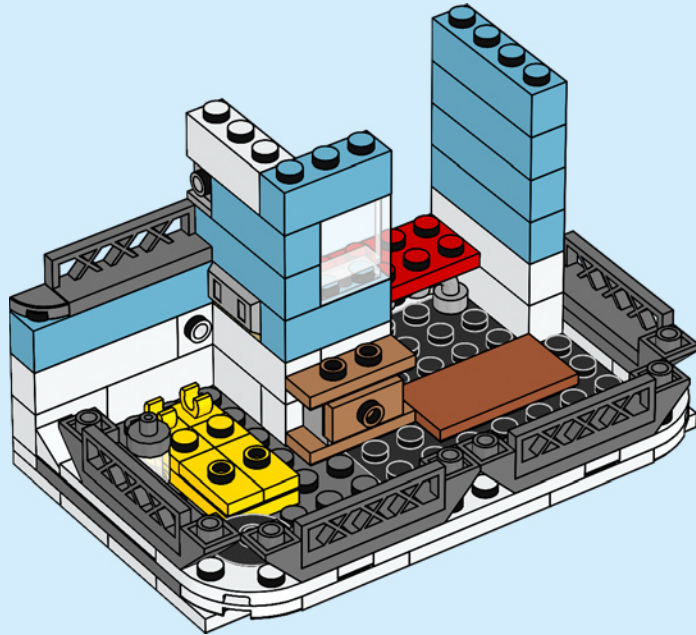

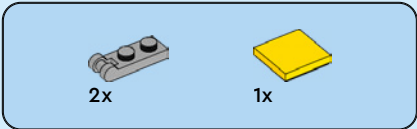

# 26

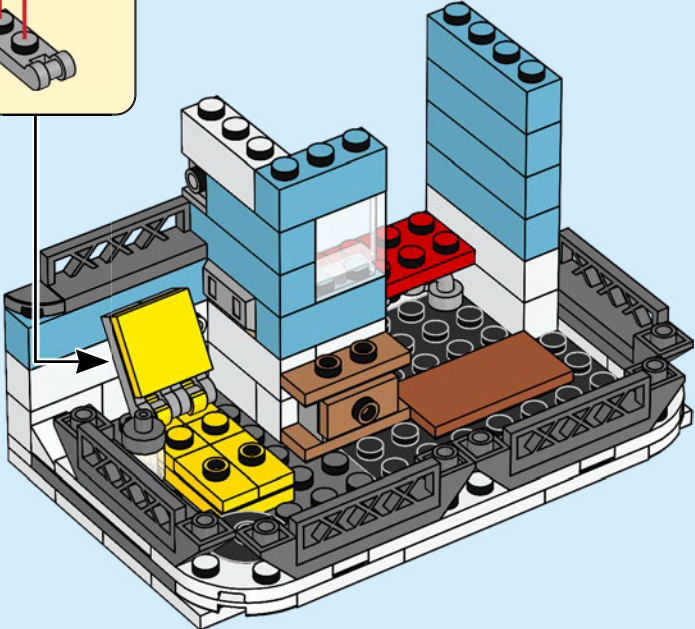
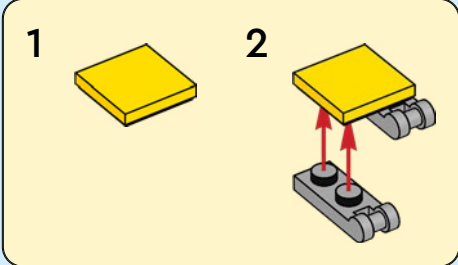

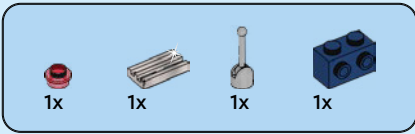

27

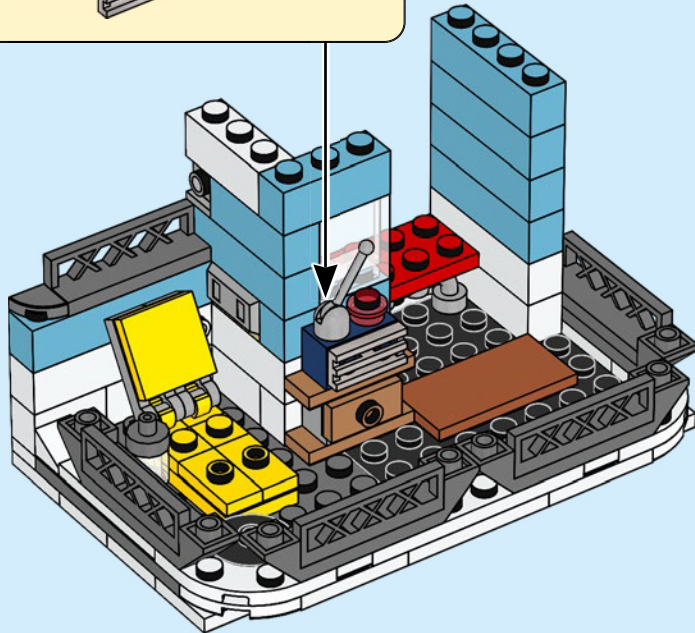
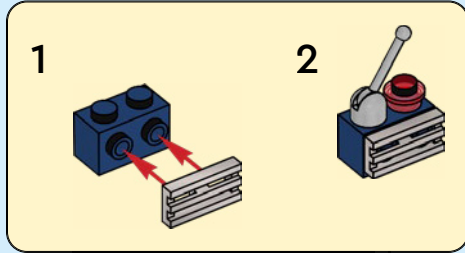

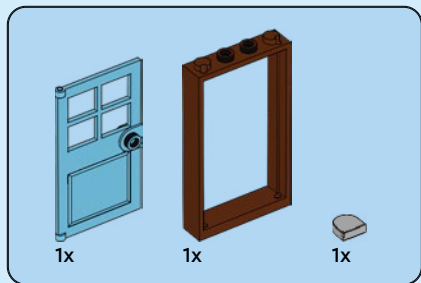

28

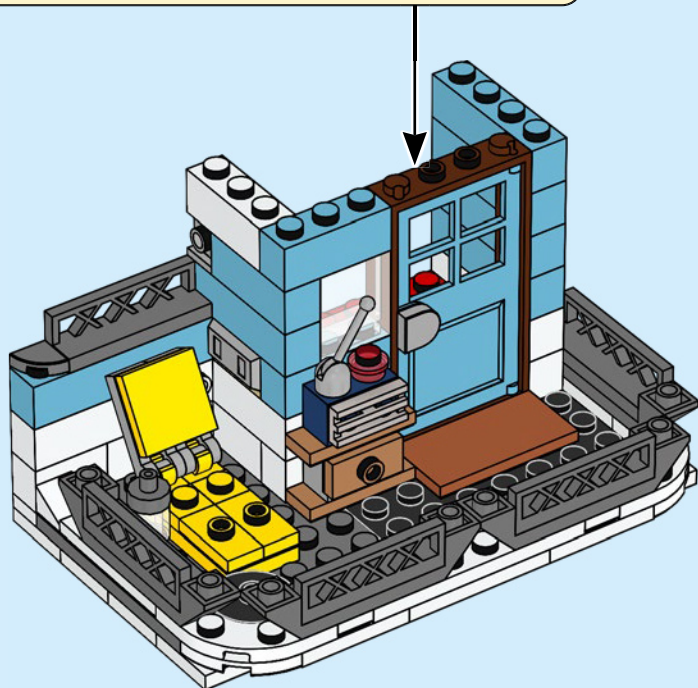
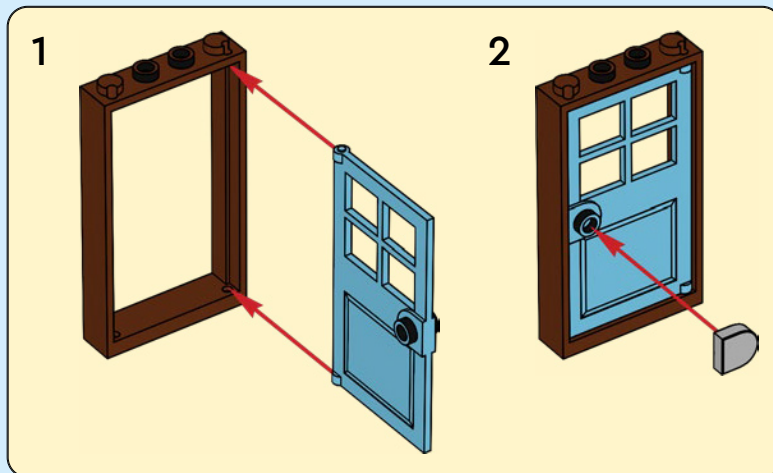



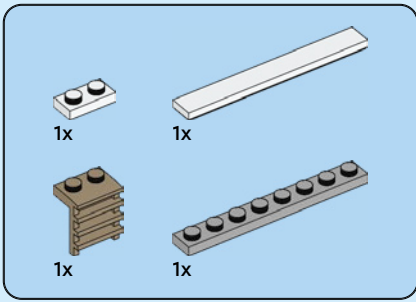

29

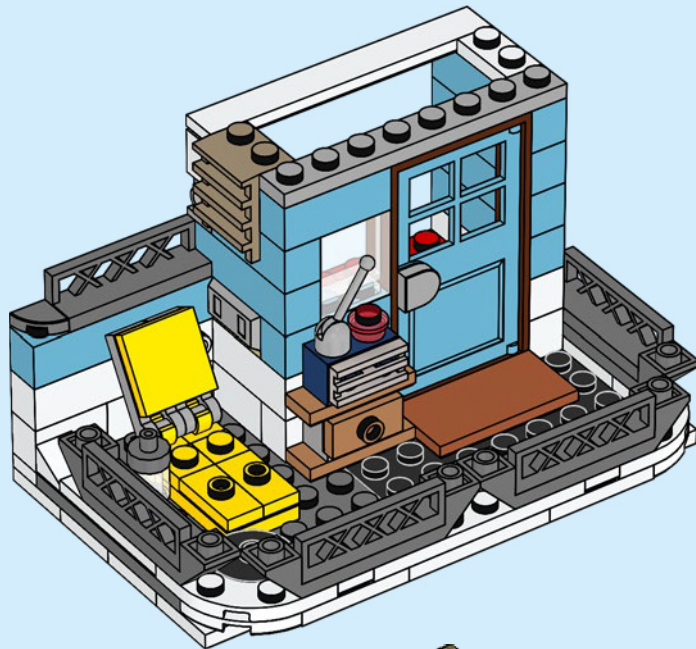

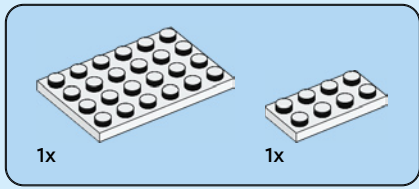

30

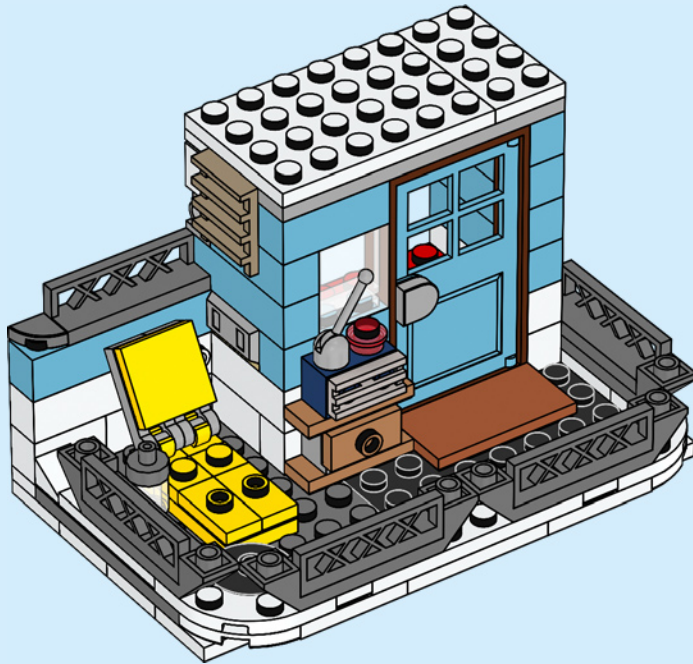

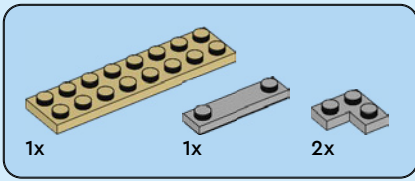

31

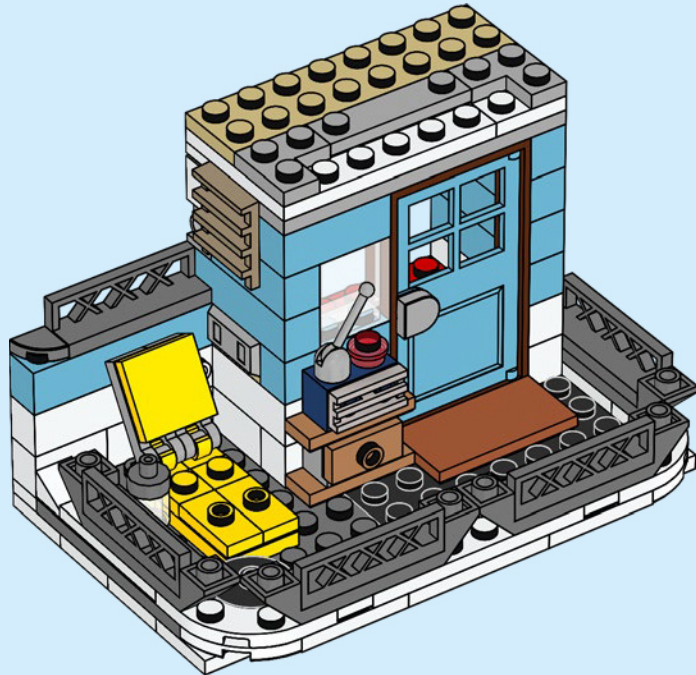



1x



2x

32

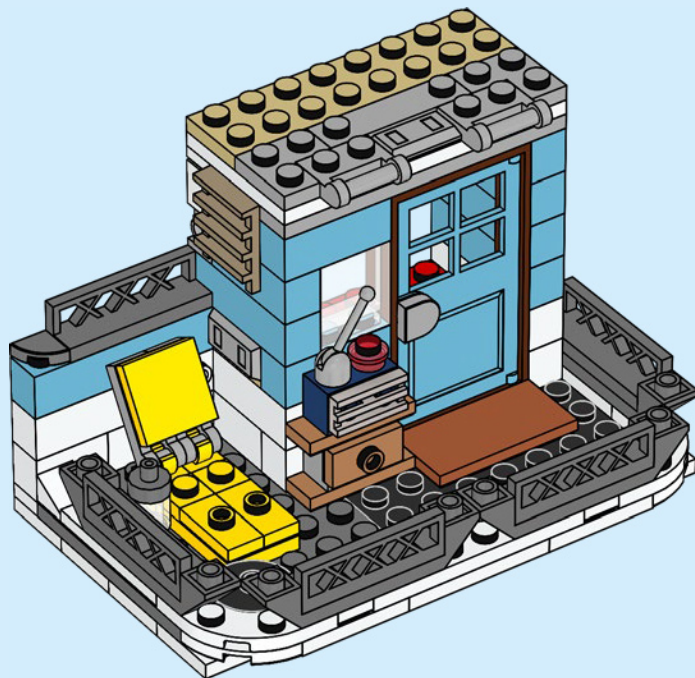

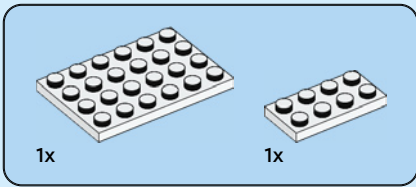

33

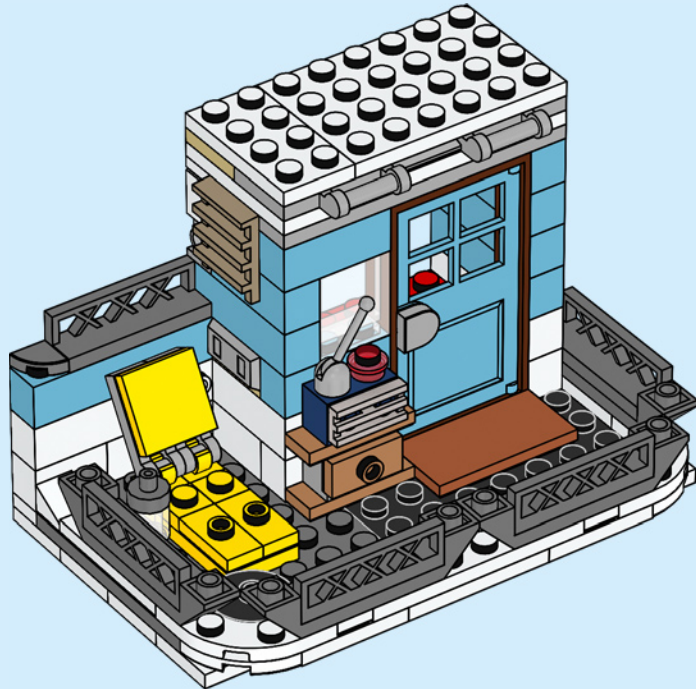





6x

34

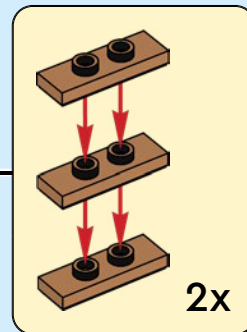
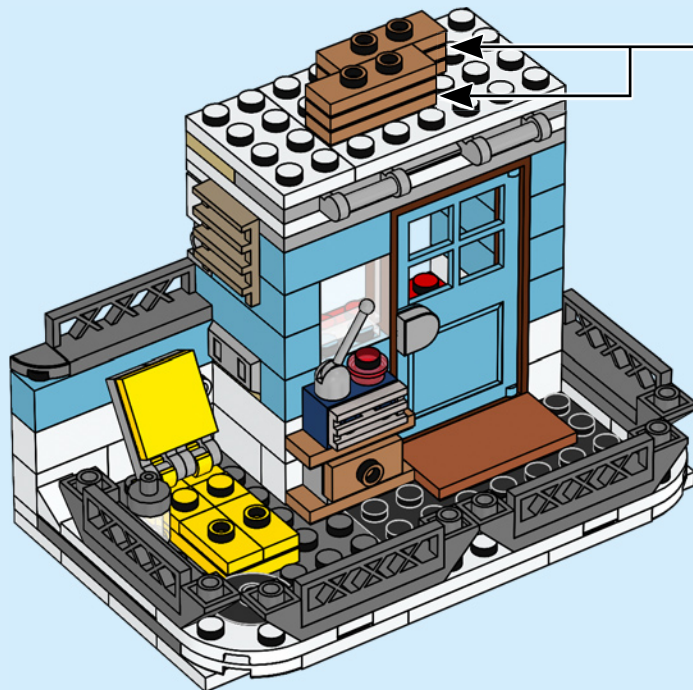



2x

35

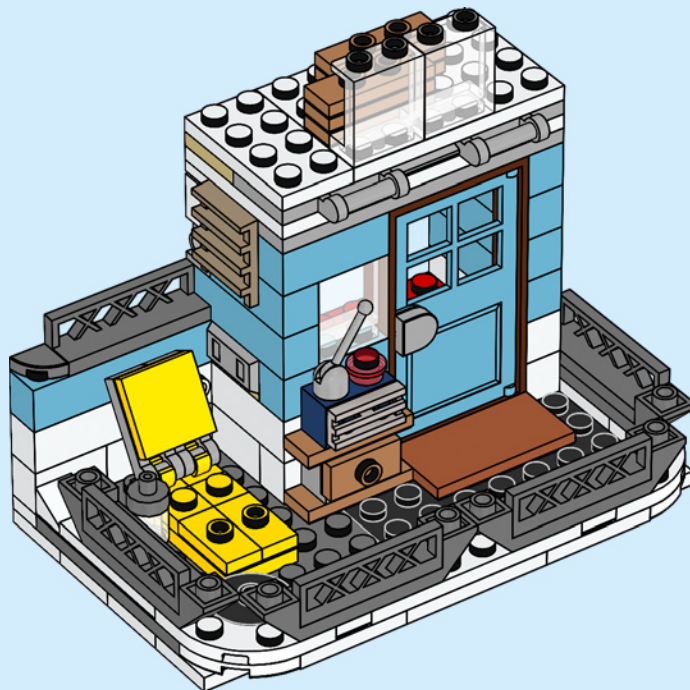

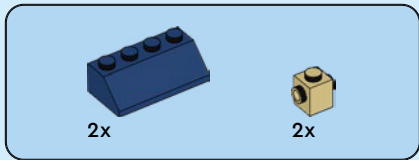

36

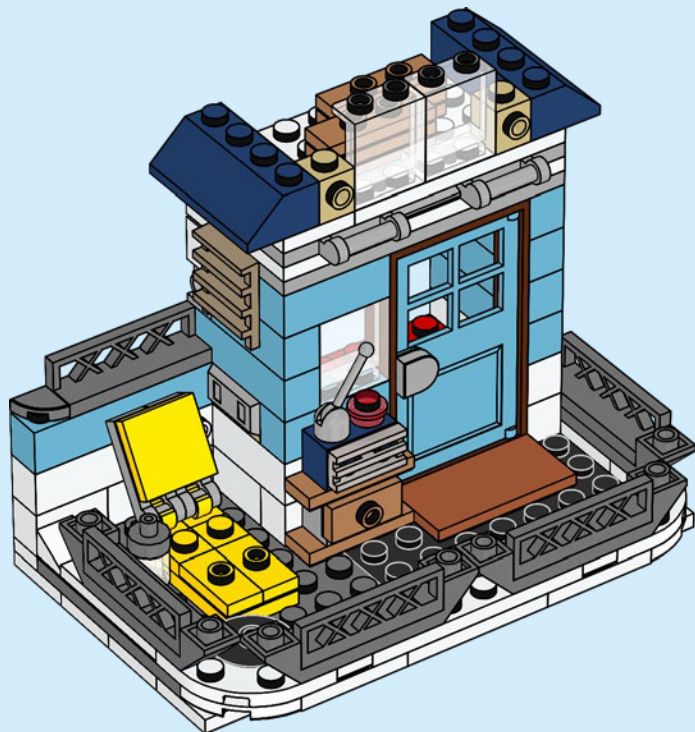



2x

37

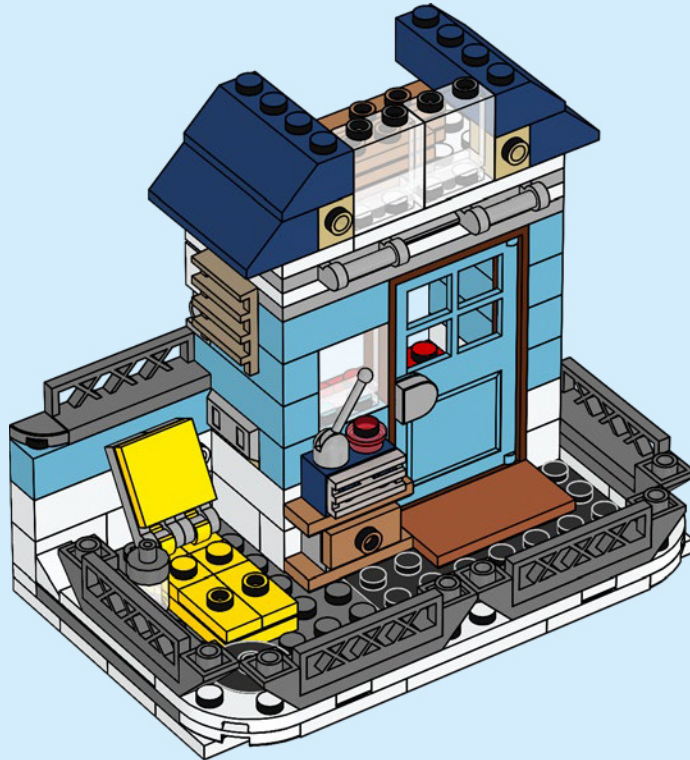

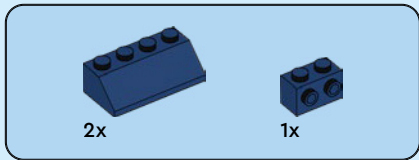

38

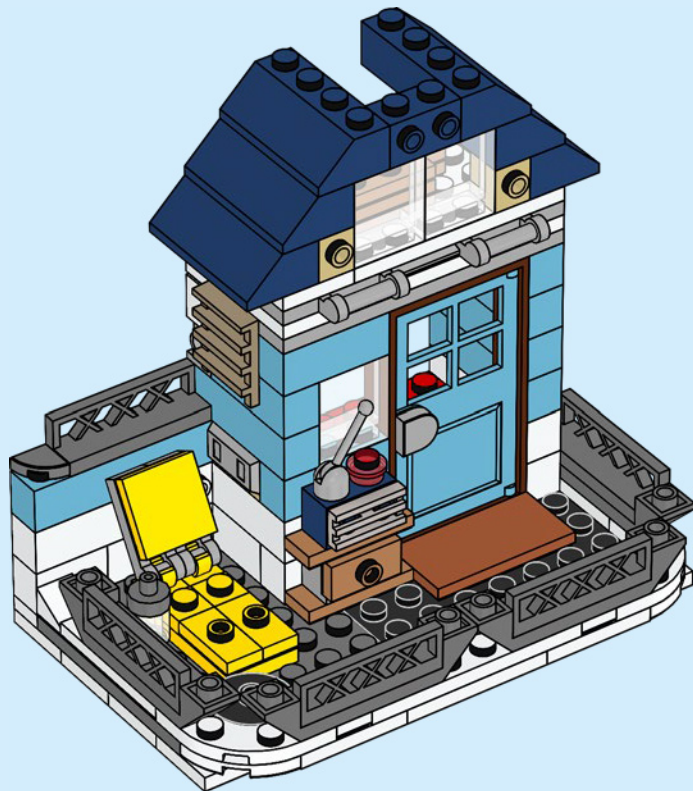



2x

39

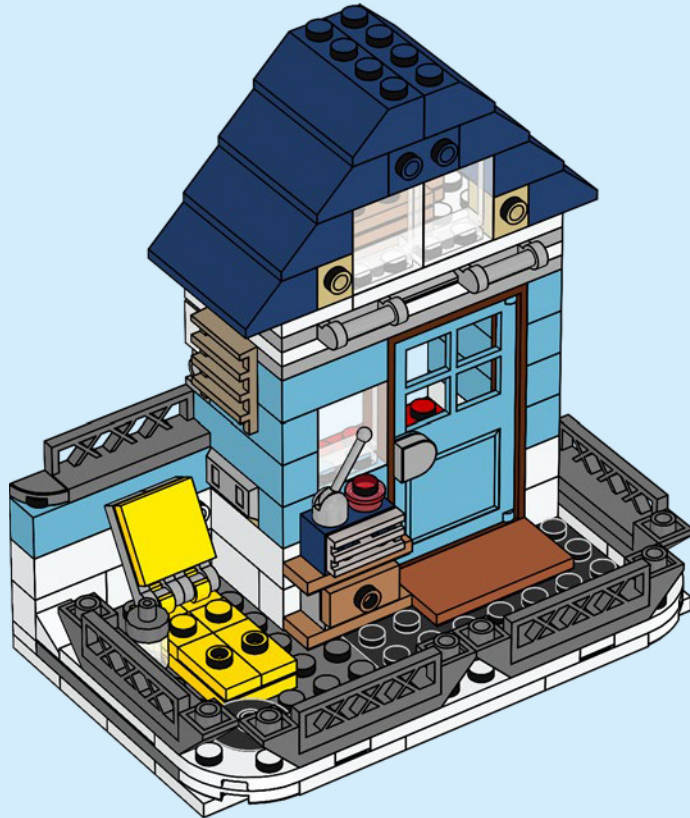





4x

40

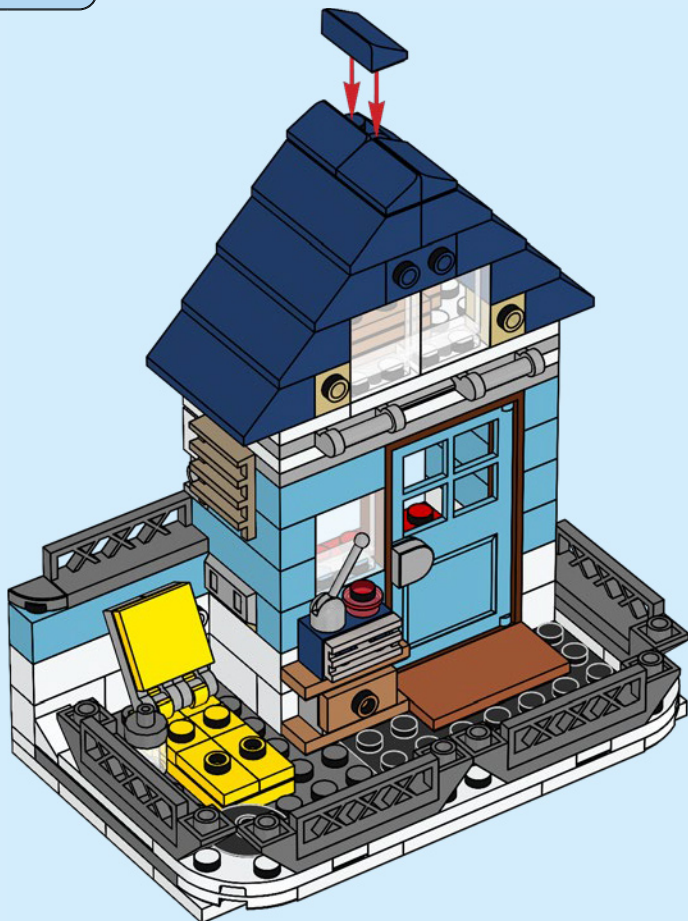



4x

41

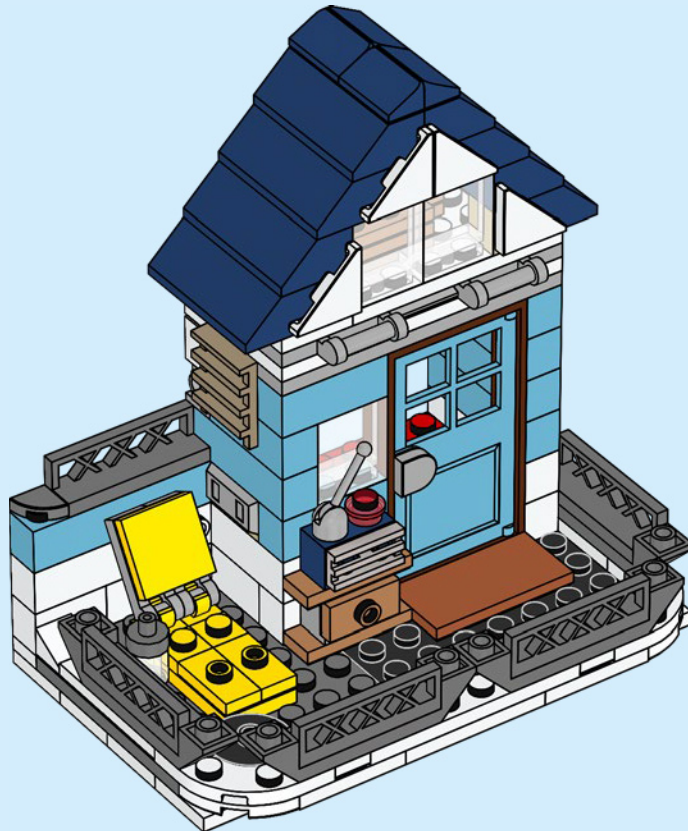

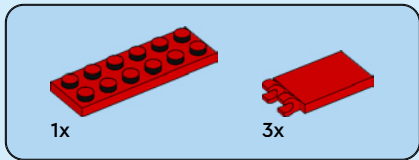

42

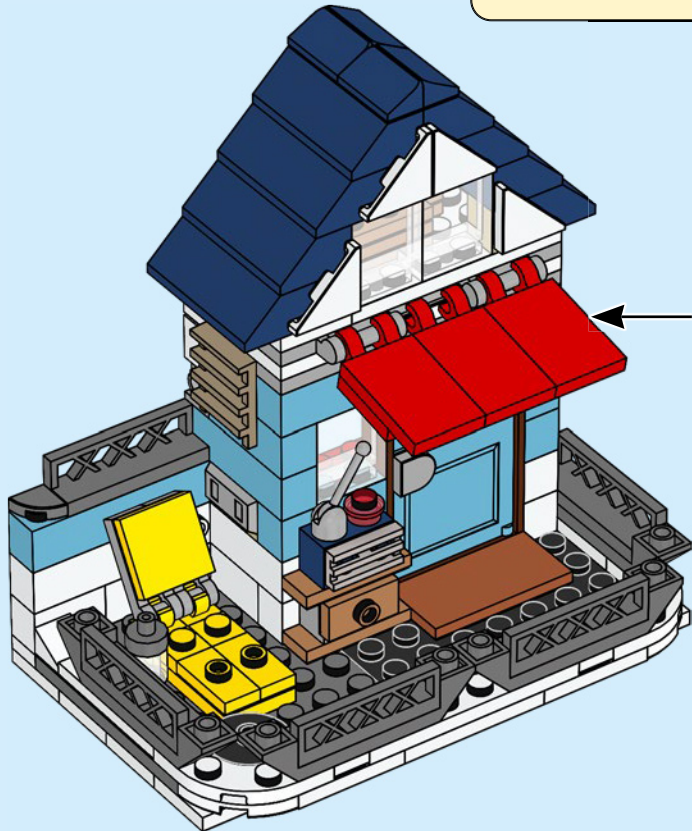
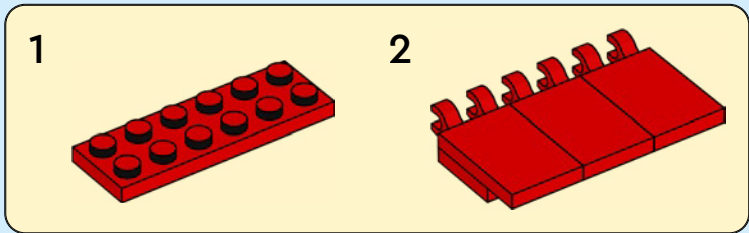



1x



1x



1x

# 43

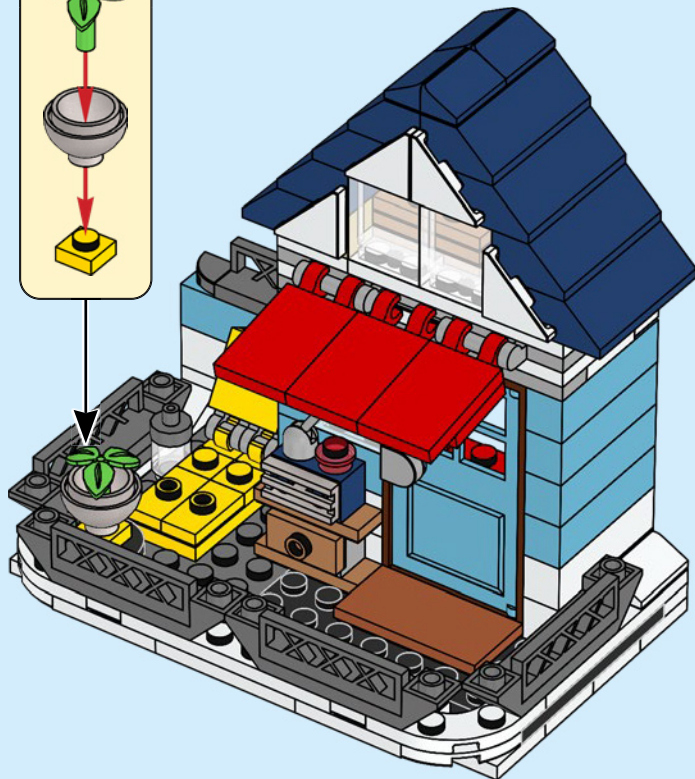
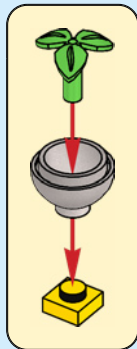

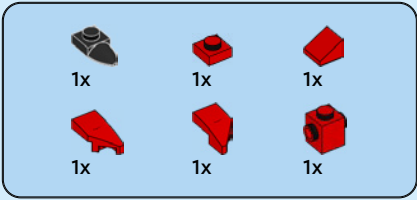

# 44

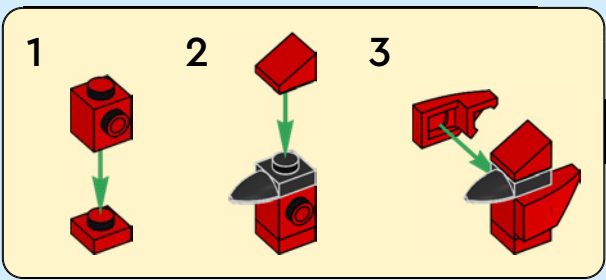



45





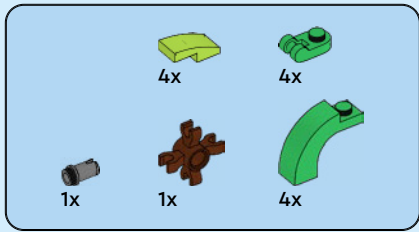

46

1



2

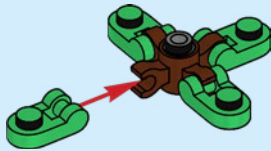

3

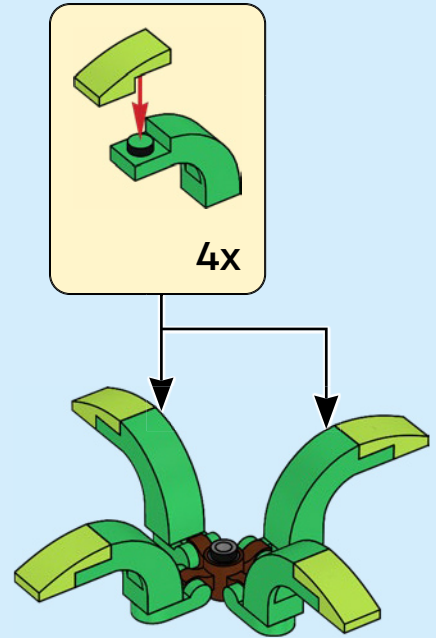

5



