

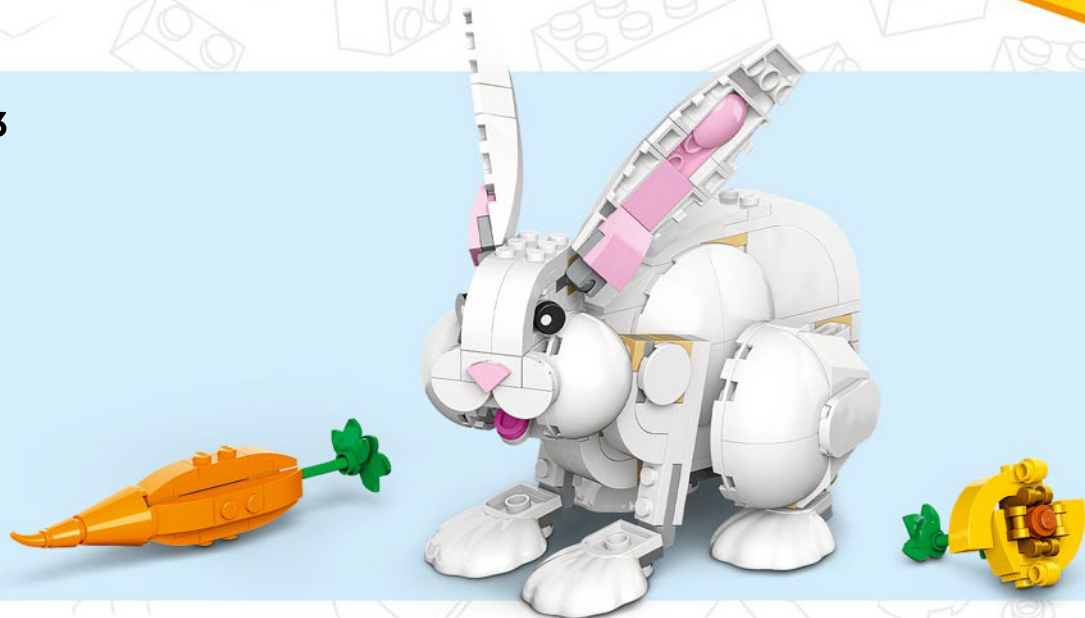

CREATOR™



31133



3 in 1	3 合 1	3 v 1	„3 в 1“
3 en 1	3 Ե 1	3 az 1-ben	Kolm ühes
3 em 1	3 w 1	3 în 1	3 viename



 **FR**
DONNEZ
OU
RECYCLEZ

 OU  OU 

ASSOCIATION MAGASIN DÉCHÈTERIE

Adresses sur quefairedemesdechets.fr



LEGO.com/sustainable-packaging



BUILDER



Apple and the Apple logo are trademarks of Apple Inc., registered in the U.S. and other countries and regions. App Store is a service mark of Apple Inc. Google Play and the Google Play logo are trademarks of Google LLC. Tencent and the Tencent logo are trademarks of Tencent Inc.

Q [LEGO.com/devicecheck](https://www.lego.com/devicecheck)

EN Ask parents' permission before going online | **DE** Eltern um Erlaubnis bitten, bevor du online gehst | **FR** Demande l'autorisation d'un parent avant d'aller en ligne | **IT** Chiedi il permesso ai tuoi genitori prima di andare online | **ES** Pídeles permiso a tus papás antes de conectarte a Internet | **PT** Pede autorização aos pais antes de acederes online | **JA** オンラインになる前に ほか者の方のきよかをもらおう | **ZH** 上网前应先征得父母的同意 | **KO** 온라인 접속 전에 보호자 동의가 필요합니다 | **RU** Спроси разрешения у родителей, прежде чем заходить в интернет | **PL** Poproś rodziców o zgodę, zanim wejdziesz do Internetu | **CS** Než půjdeš na internet, požádej rodiče o svolení | **SK** Skôr než pôjdeš na internet, vypýtaj si povolenie od rodičov | **HU** Kérj szülői engedélyt, mielőtt online csatlakoznál! | **RO** Cere permisiunea părinților înainte de a te conecta online | **BG** Поискайте разрешение от родител, преди да влезете онлайн | **LV** Pirms došanās tiešsaistē palūdz atļauju vecākiem | **ET** Enne Interneti kasutamist küsi vanematelt luba | **LT** Prieš prisijungdami prie interneto, atsklauskite tėvų



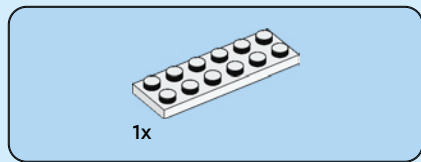

1

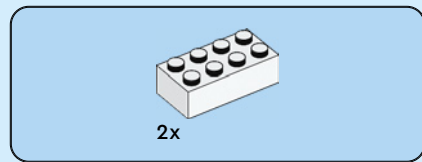
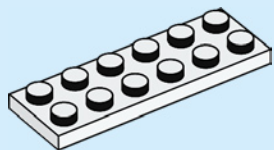

2

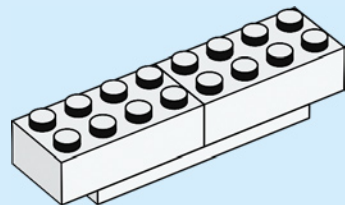



1x



1x

3

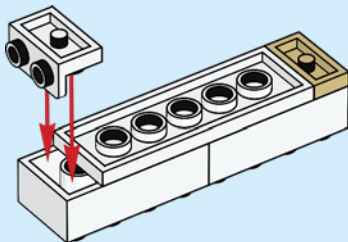
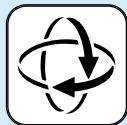

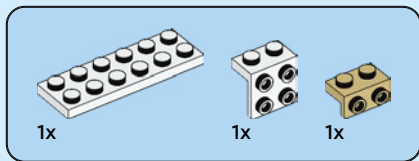

4

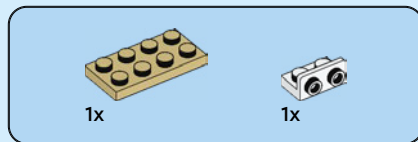
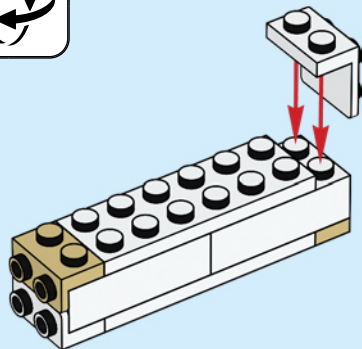
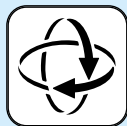

5

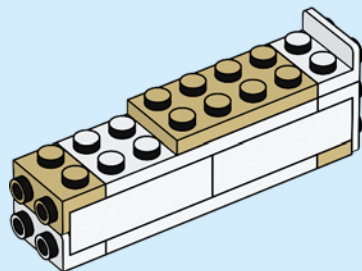



1x



1x



2x

6

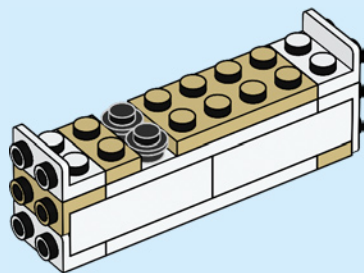

2x

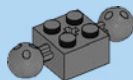

1x

7

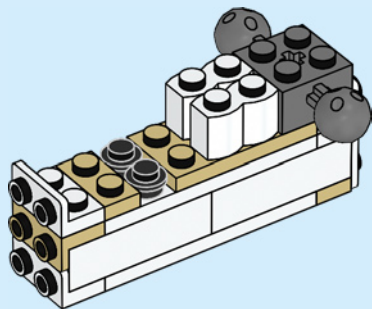



2x



1x

8

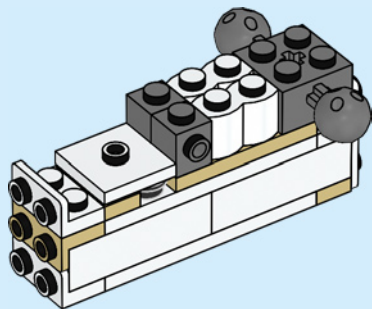

2x



1x

9

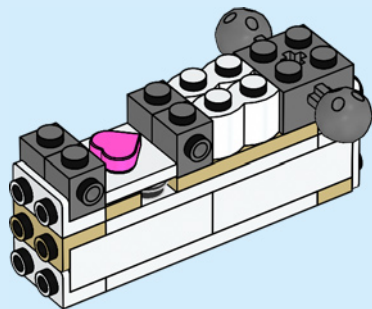

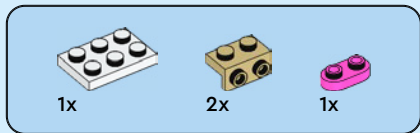

10

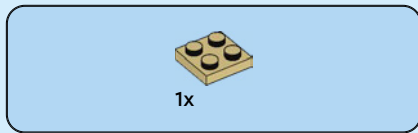
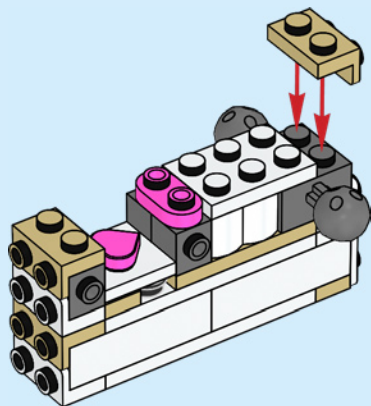

11

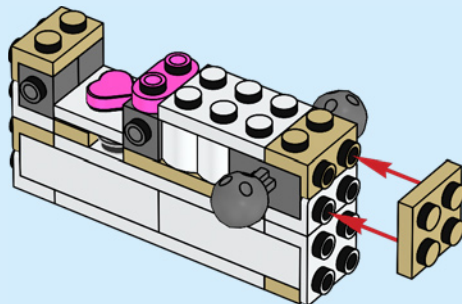



1x



1x

12

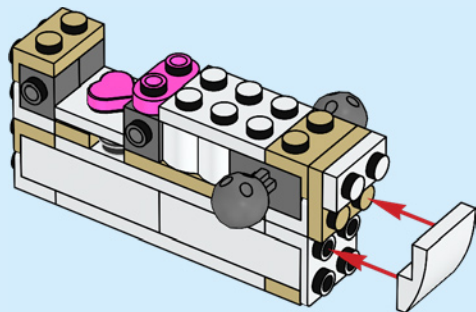

1x

13

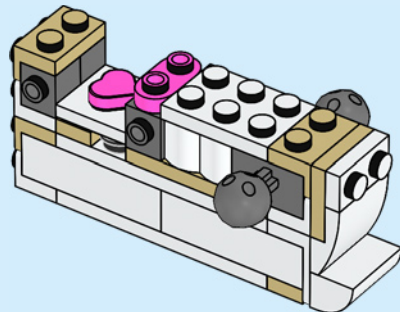

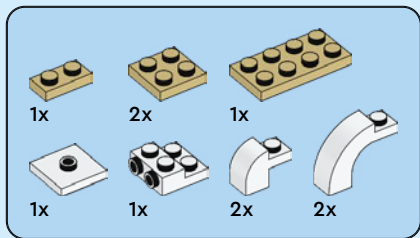

14

1

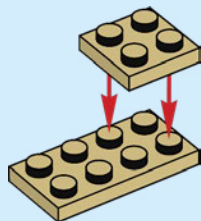

2

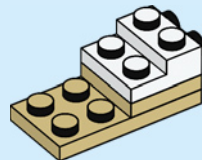

3

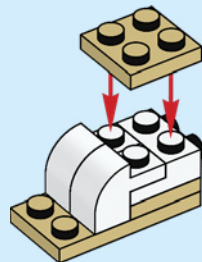

4

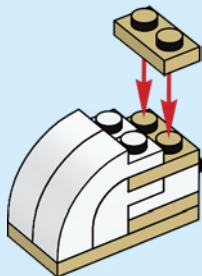

5

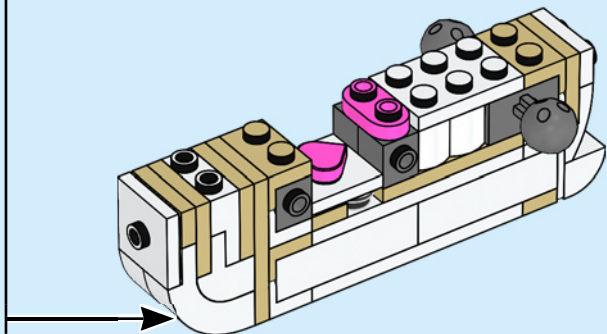
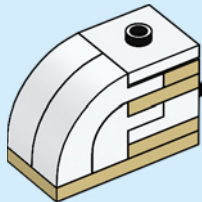

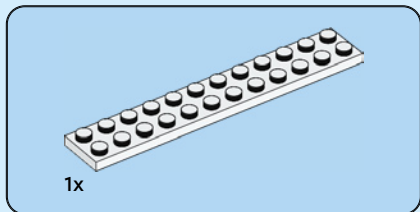
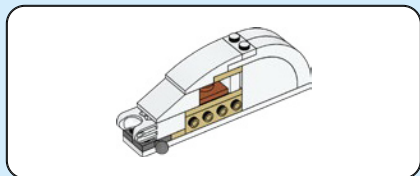

15

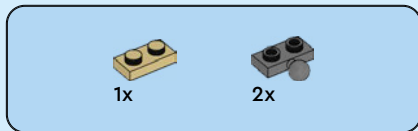
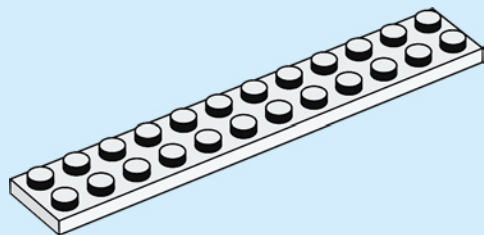

16

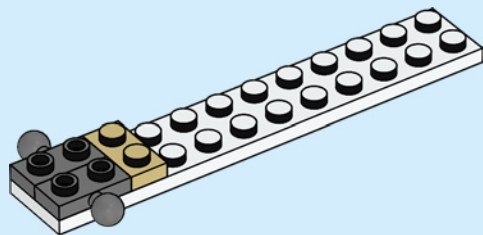

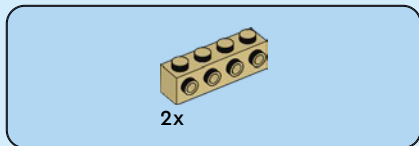

17

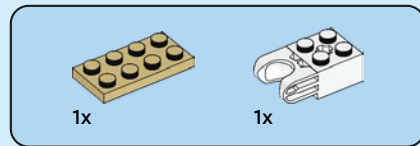
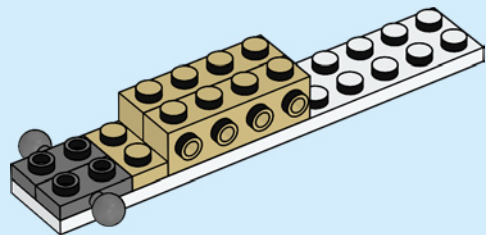

18

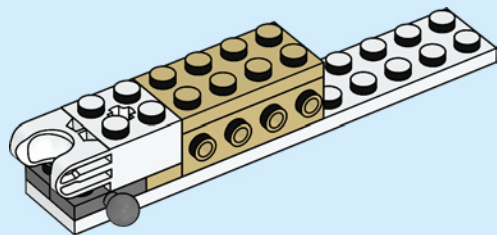

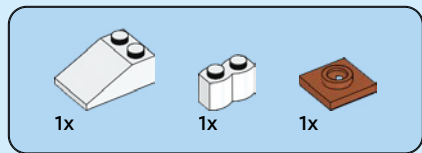

19

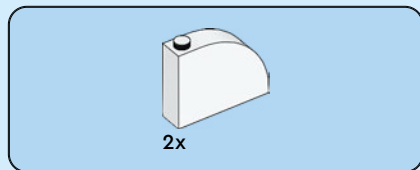
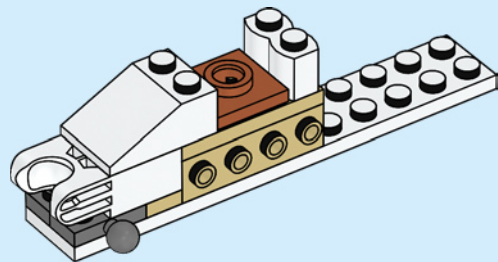

20

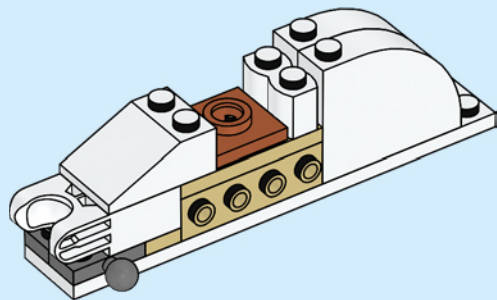



1x

21

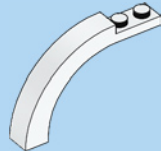
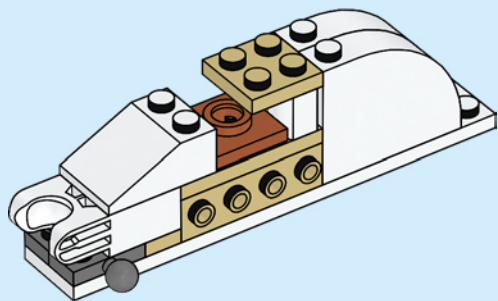

2x

22

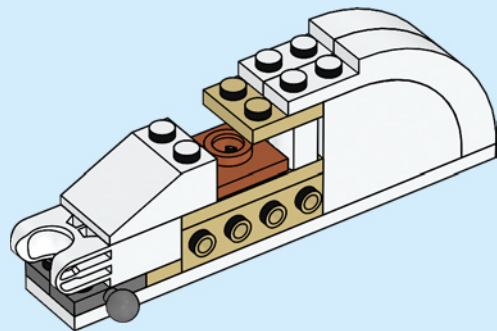

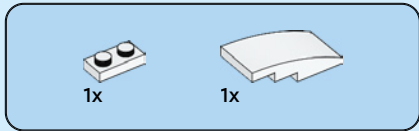

23

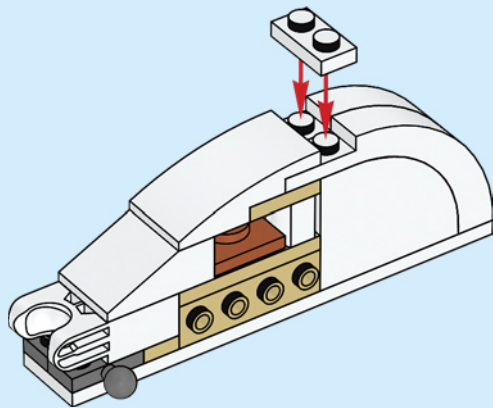

24

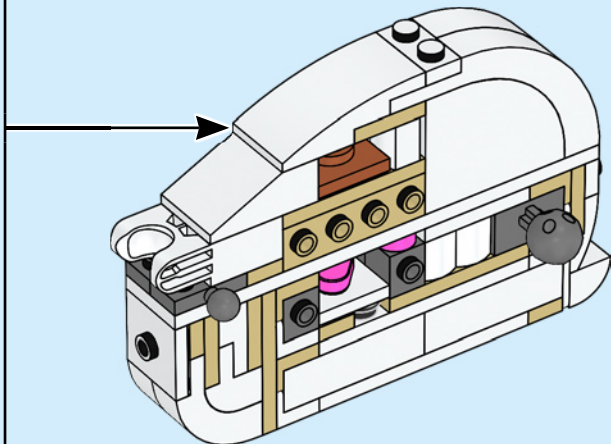



1x

25

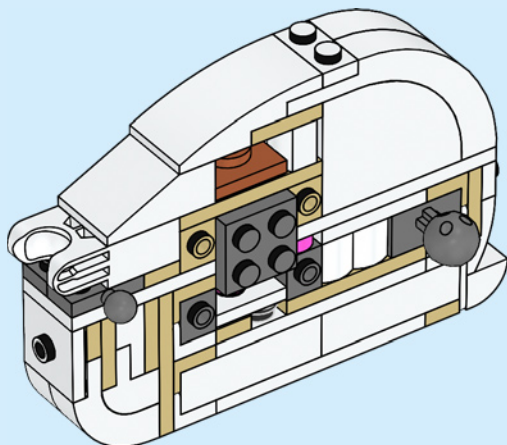

2x

26

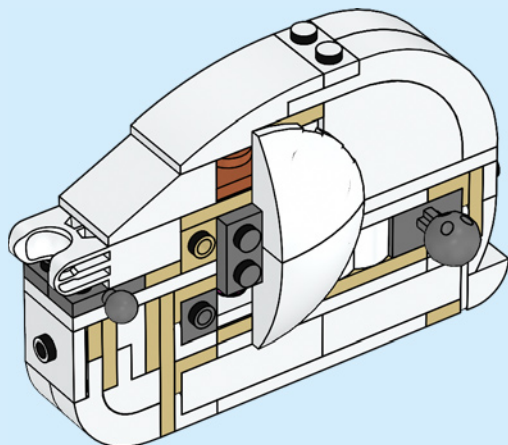



2x

27

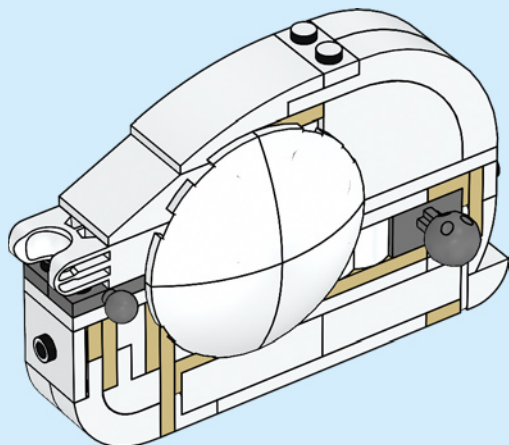

1x

28

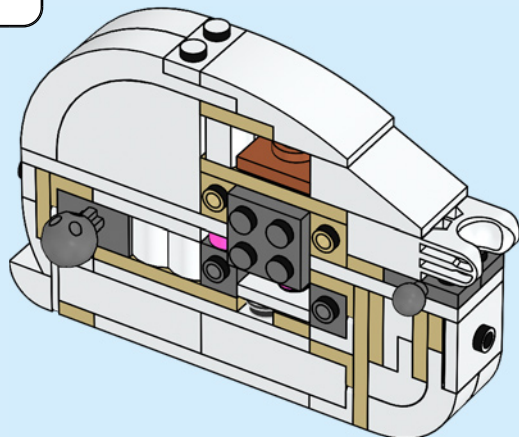



2x

29

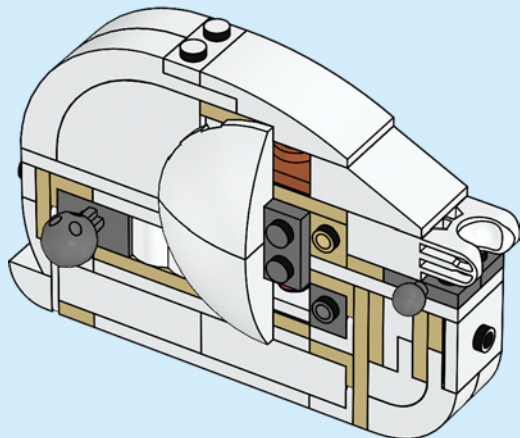

2x

30

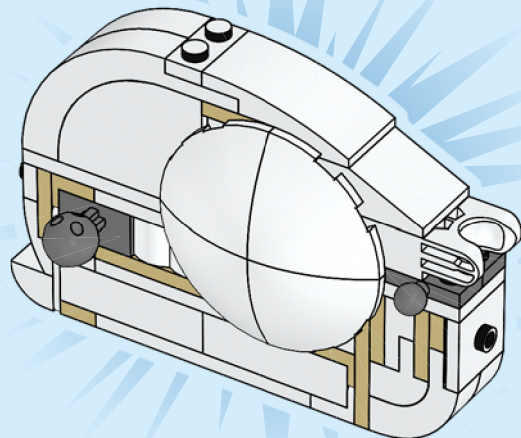

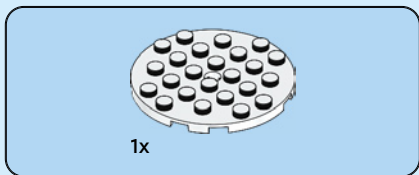
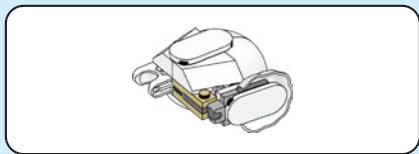

31

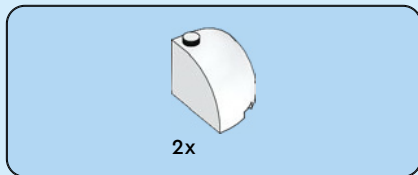
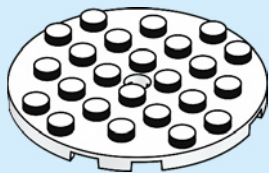

32

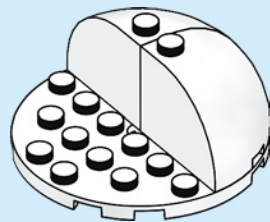



1x



1x



1x

33

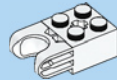
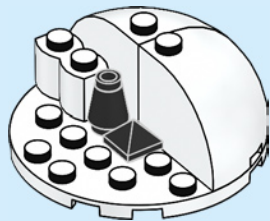

1x

34

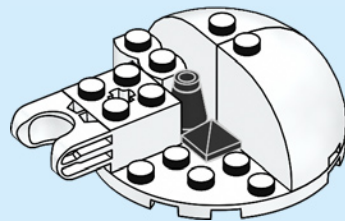



2x



1x



1x

35

1



2

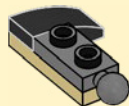

3

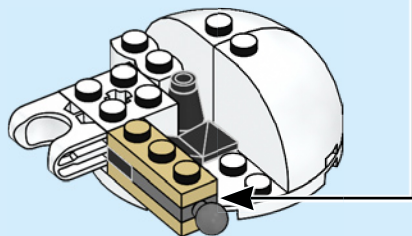
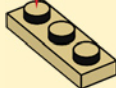
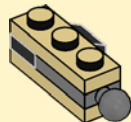

1x

36

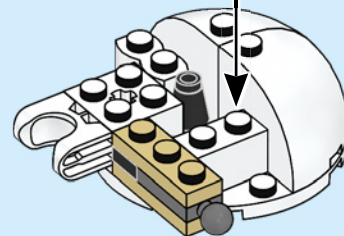
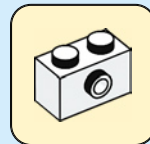



1x



1x

37

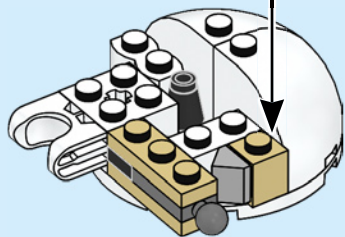
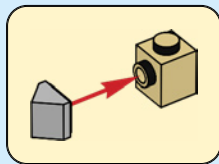

1x



1x

38

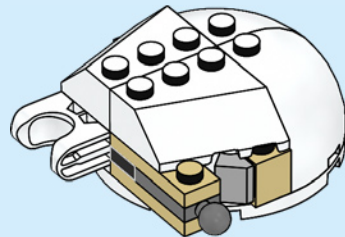



1x

39

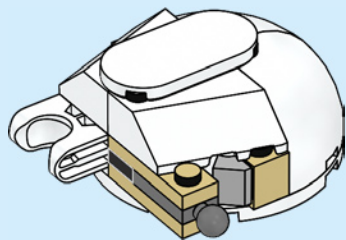

1x

40

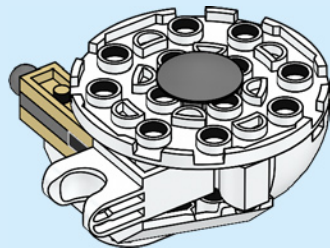

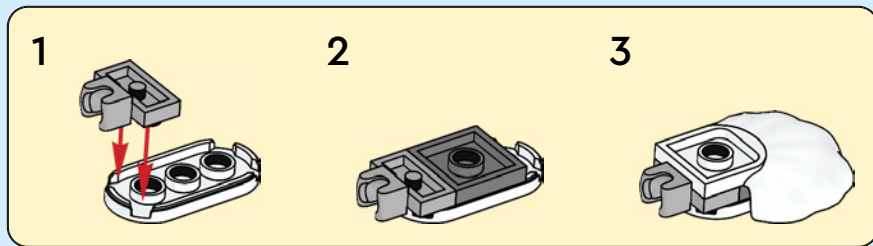
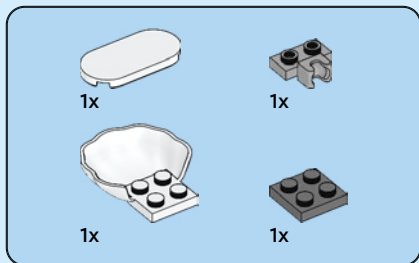

41

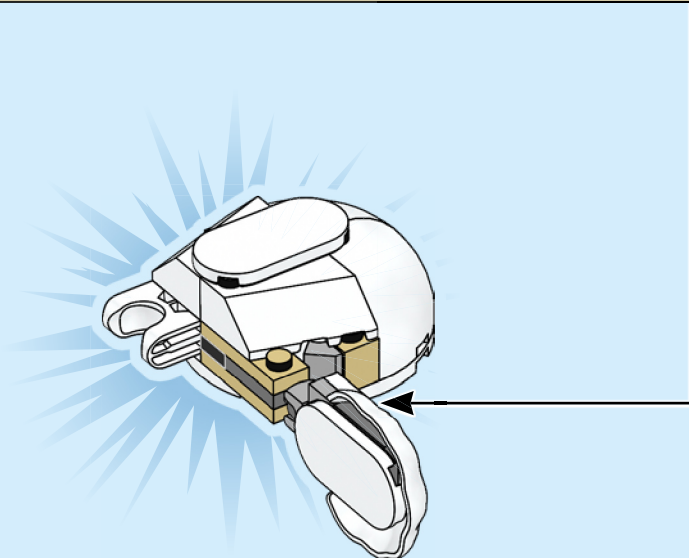
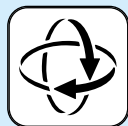

42

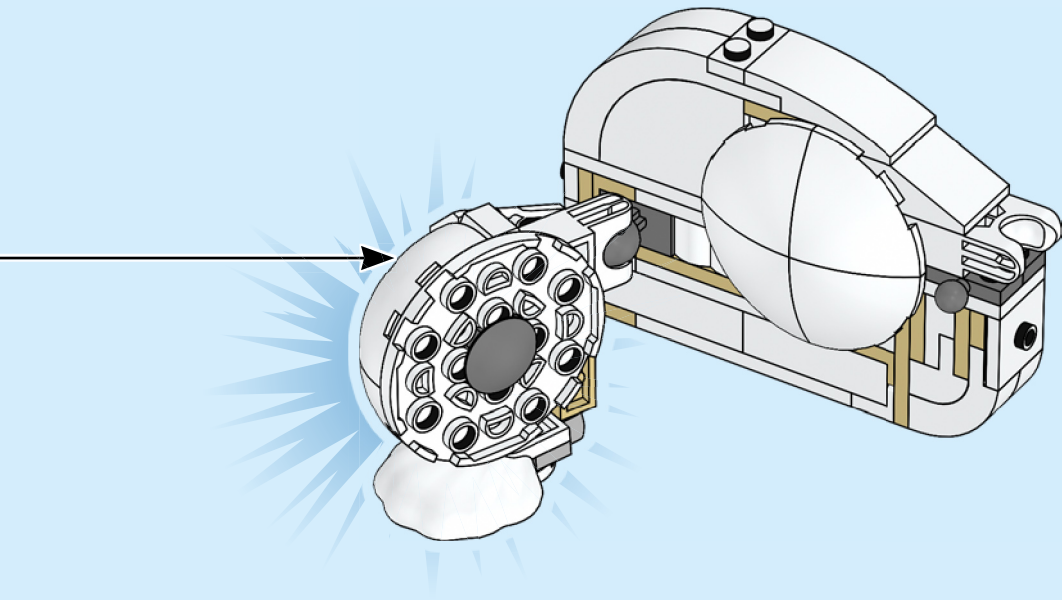

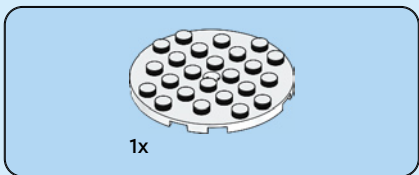
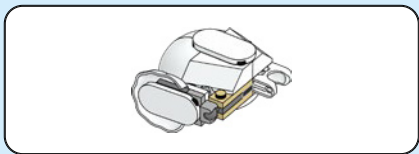

43

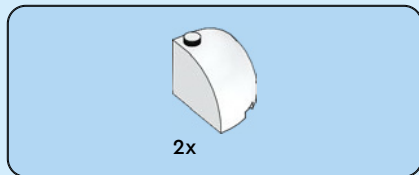
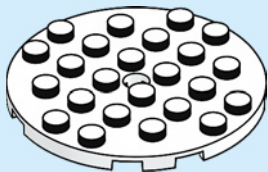

44

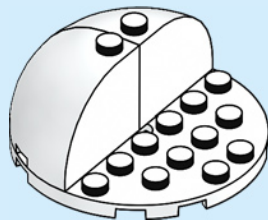



45

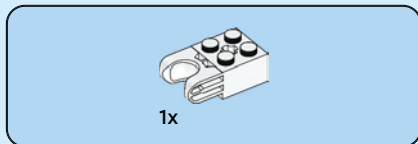
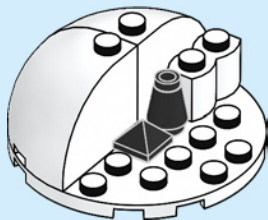

46

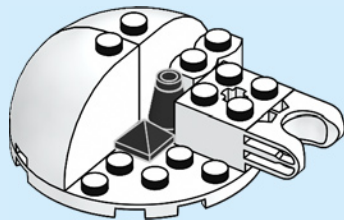

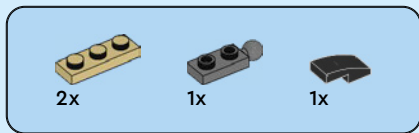

47

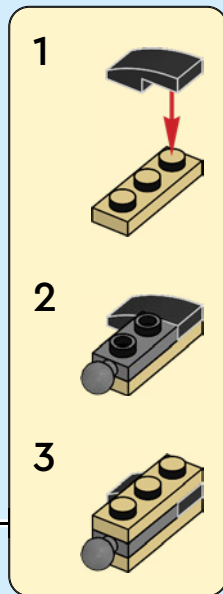
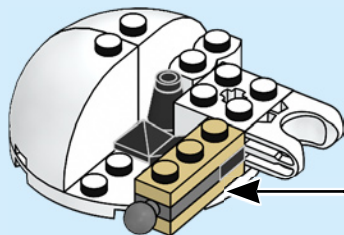



1x

48

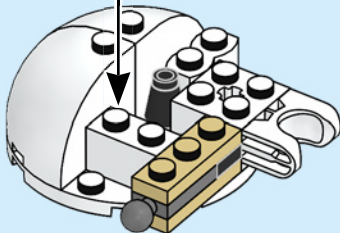
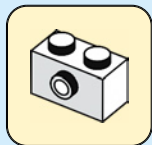

1x



1x

49

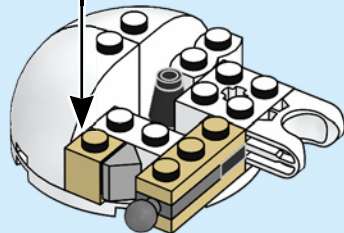
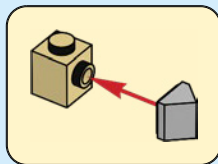

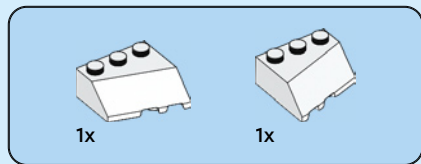

50

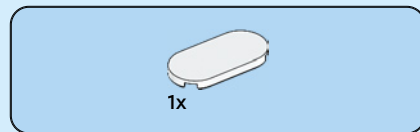
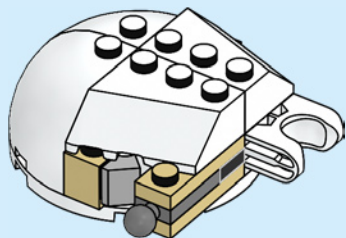

51

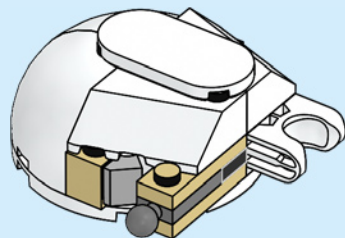



1x

52

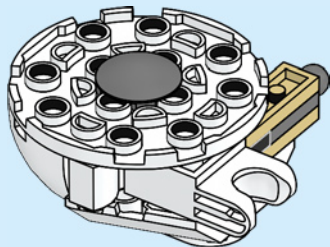

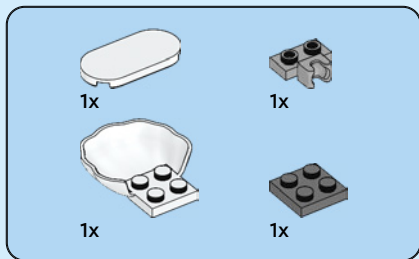

53

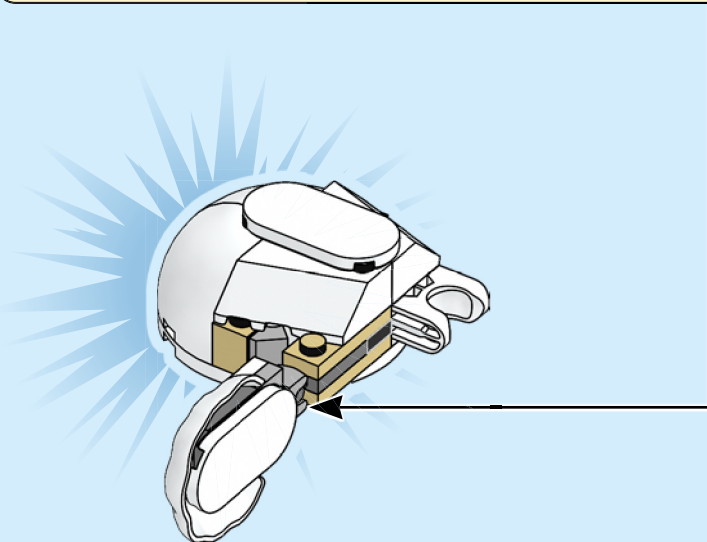
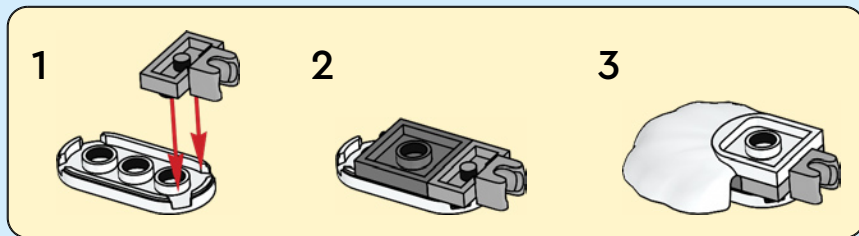

54

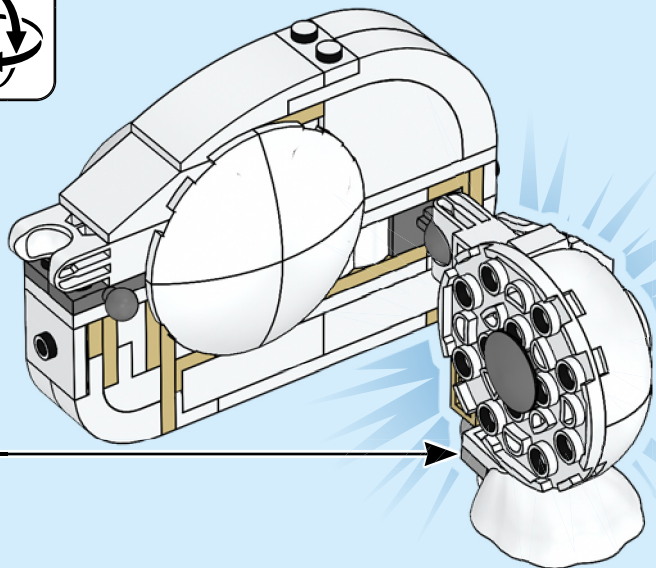

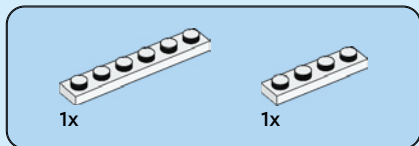
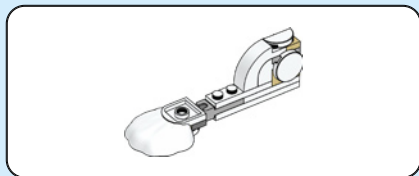

55

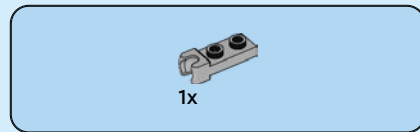
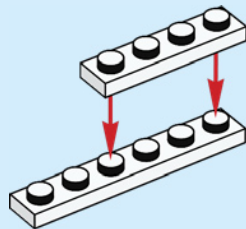

56

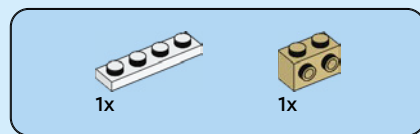
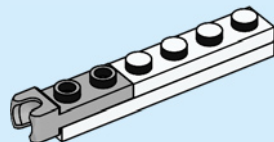

57

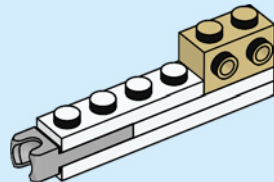



1x



1x

58

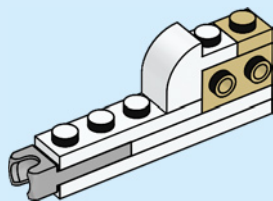

1x

59

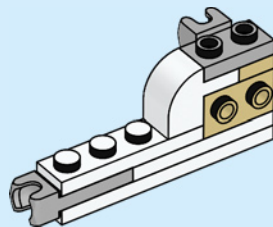

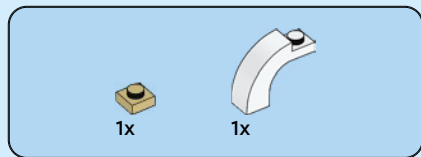

60

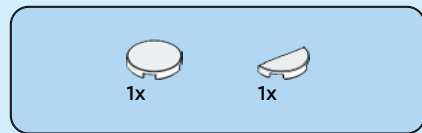
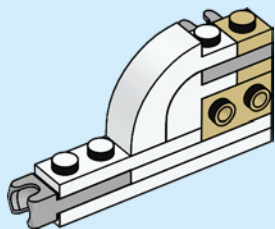

61

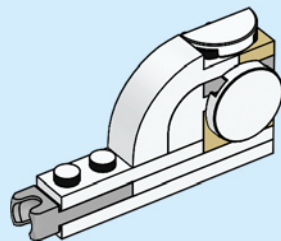

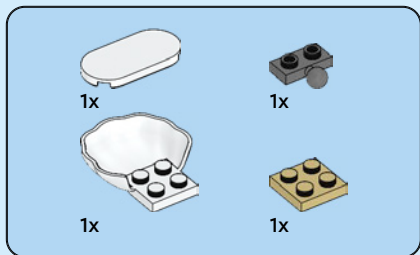

62

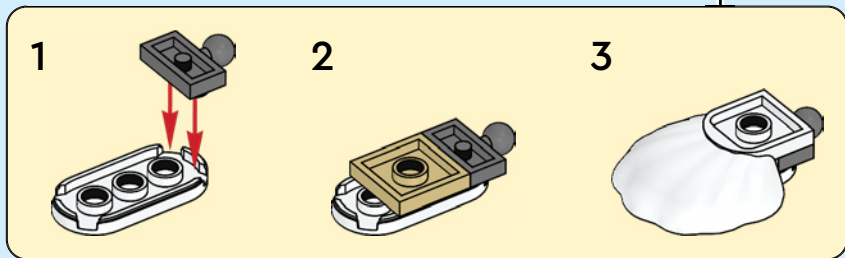
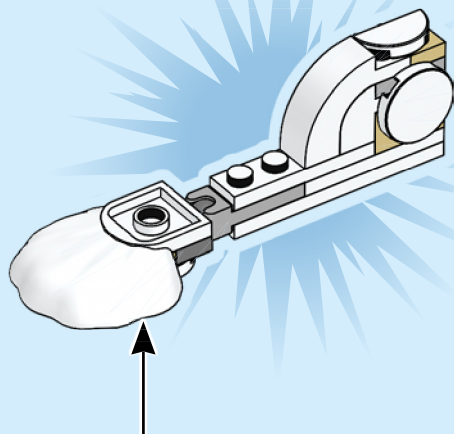

63

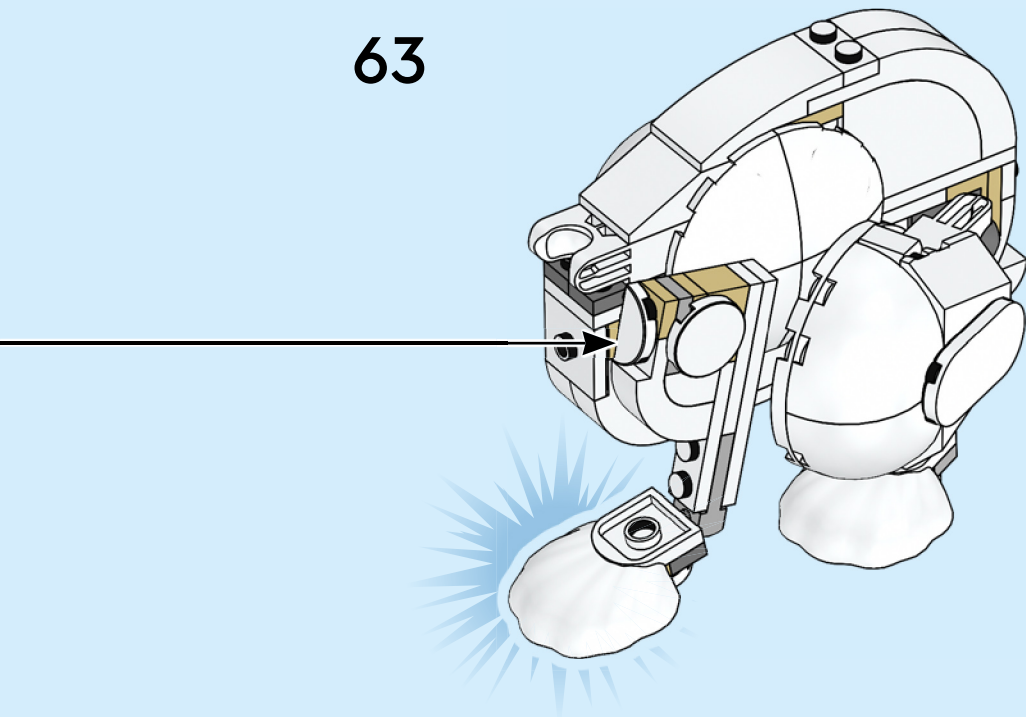

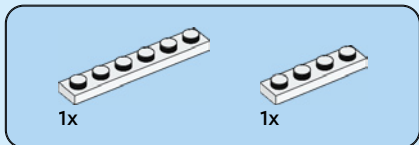
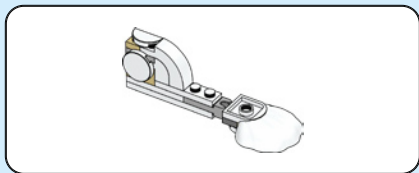

64

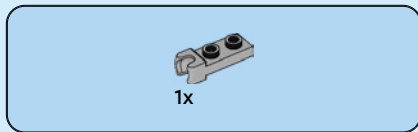
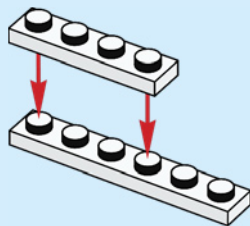

65

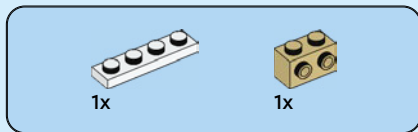
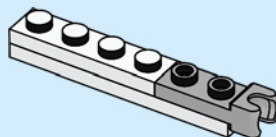

66

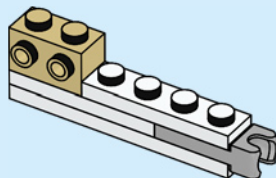



1x



1x

67

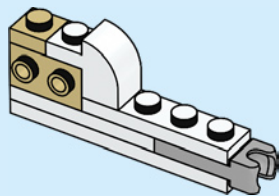

1x

68

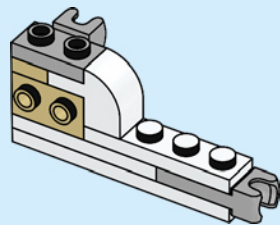

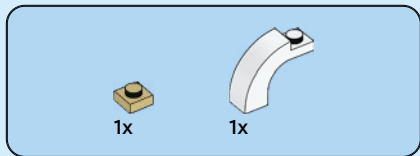

69

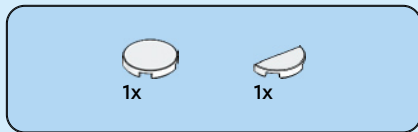
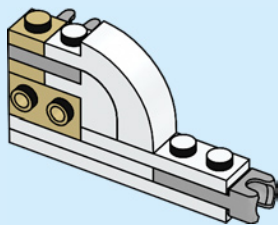

70

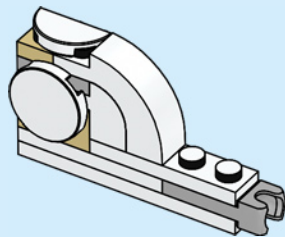

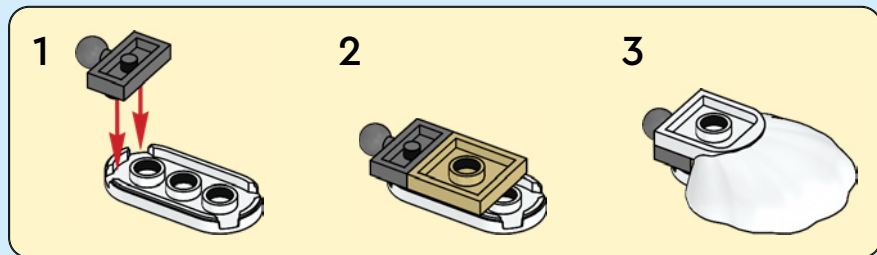
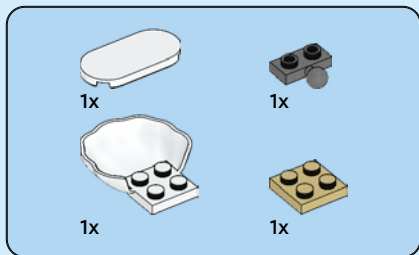

71

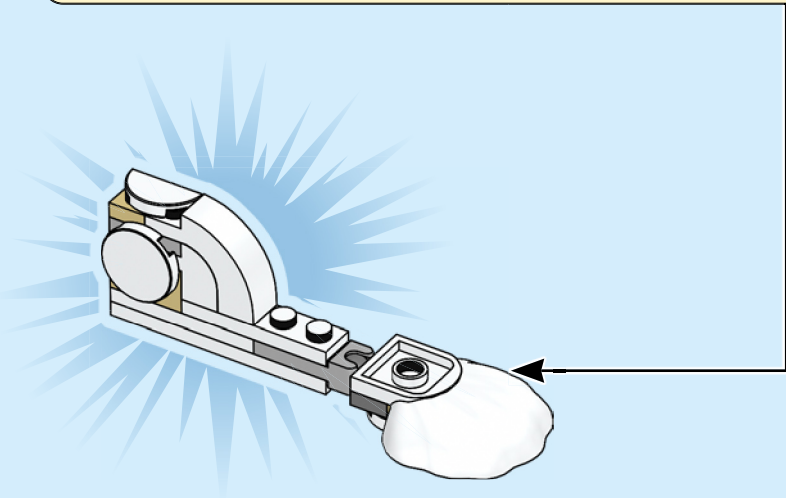

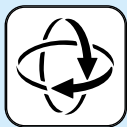

72

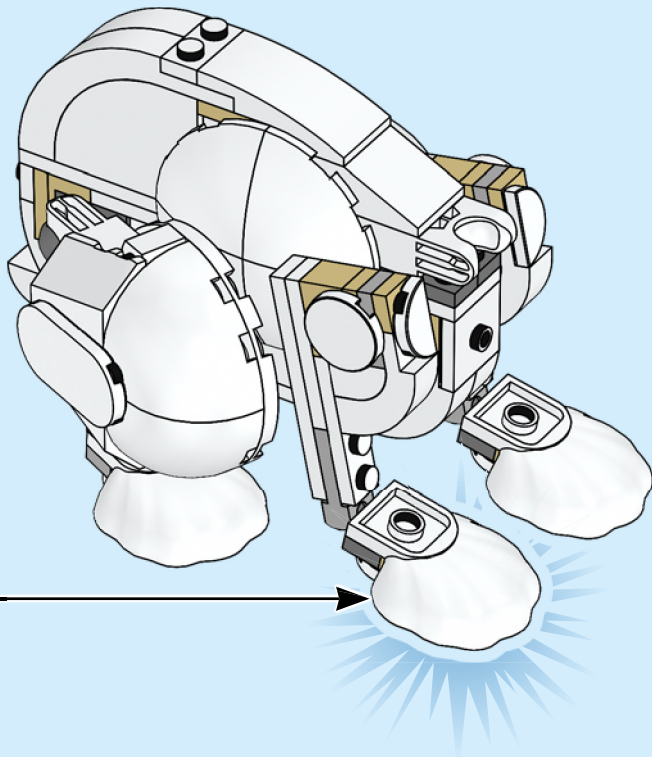

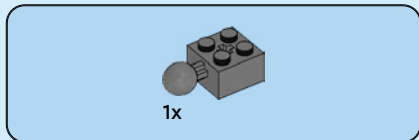
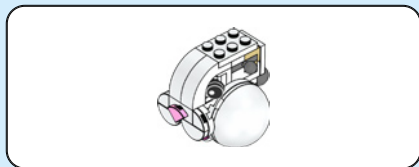

73

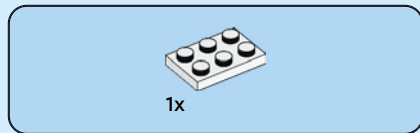
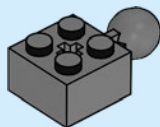

74

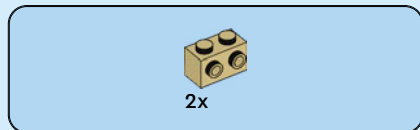
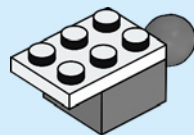

75

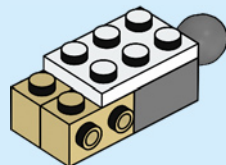



1x

76

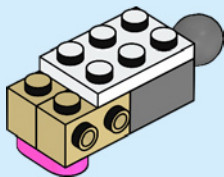

1x

77

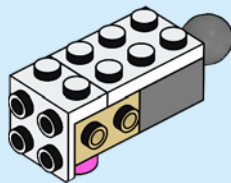

1x



1x



2x

78

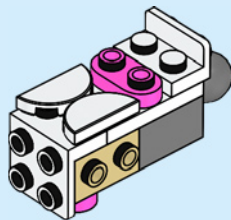



1x



1x



2x



2x



1x



1x



1x

79

1

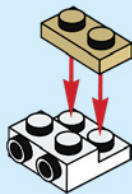

2

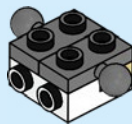

3

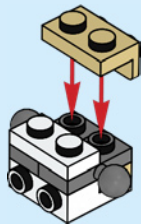

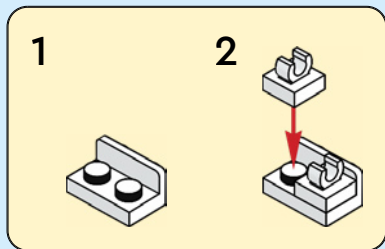

4

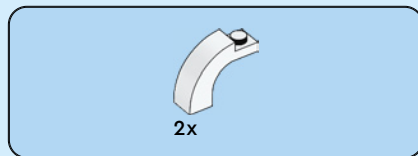
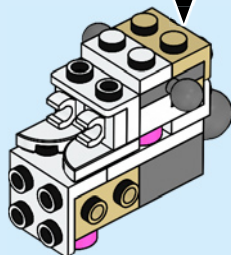
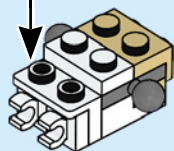

80

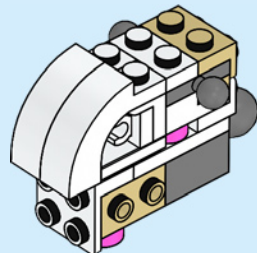

2x

2x

81

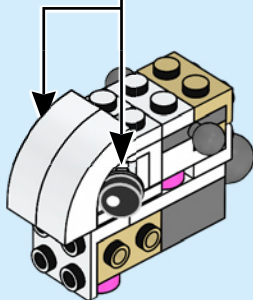
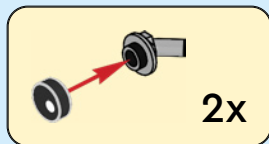

1x

1x

82

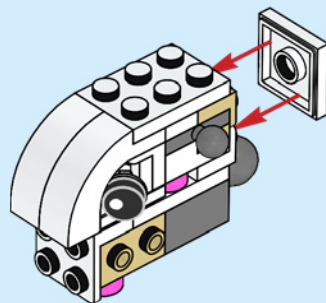

6

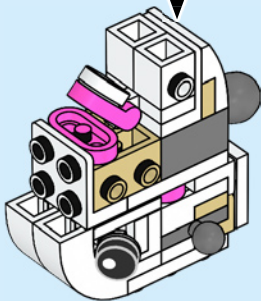
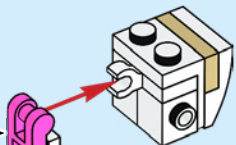
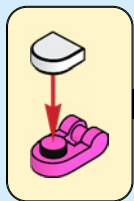

2x



2x



84

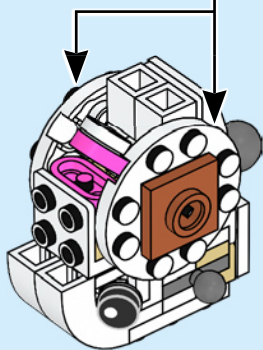
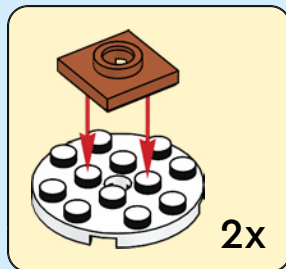

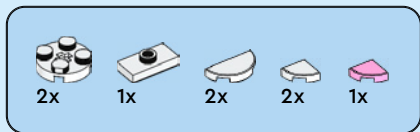

85

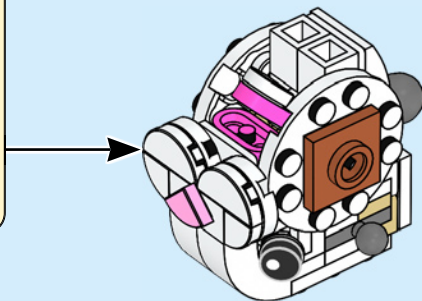
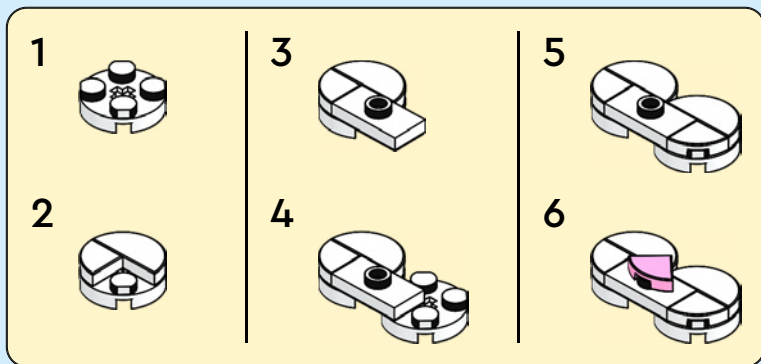



2x

86

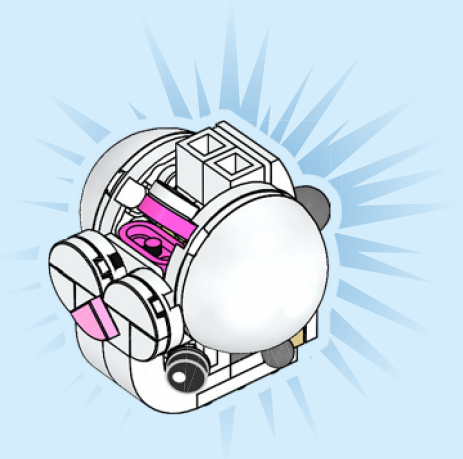

87

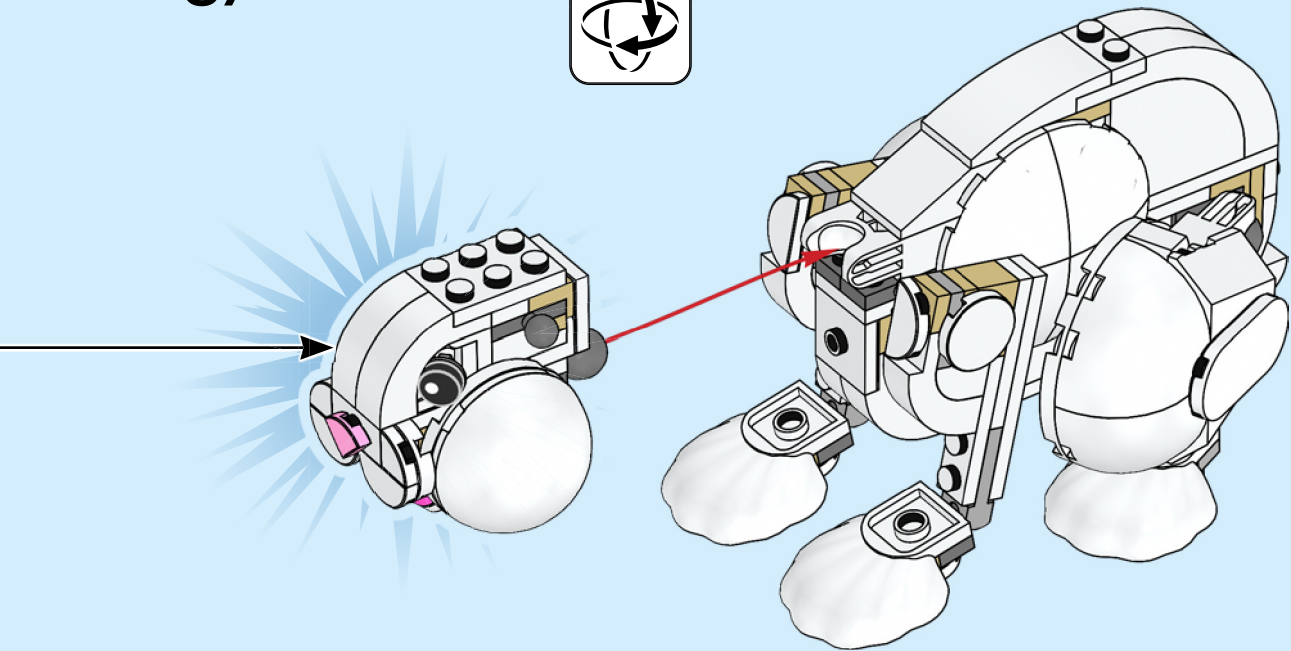



2x



4x



4x



2x



2x



2x



4x



2x

88

1

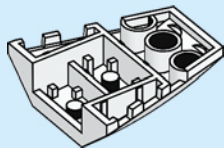

2

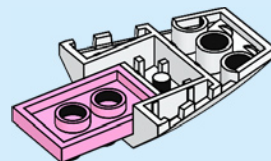

3

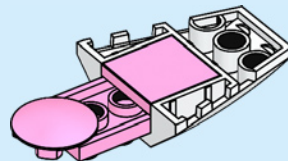

4

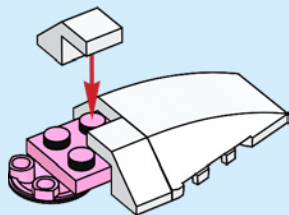

5

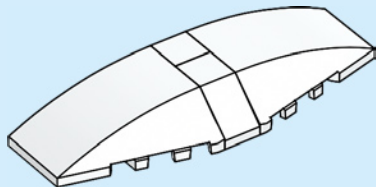

6

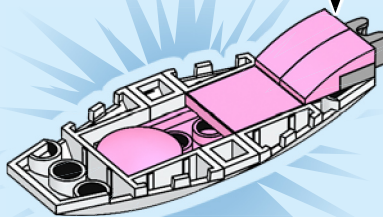
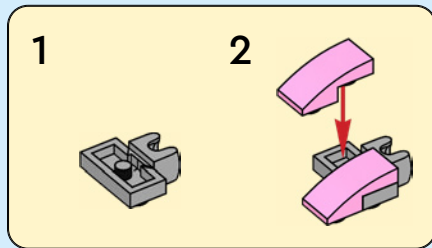

2x

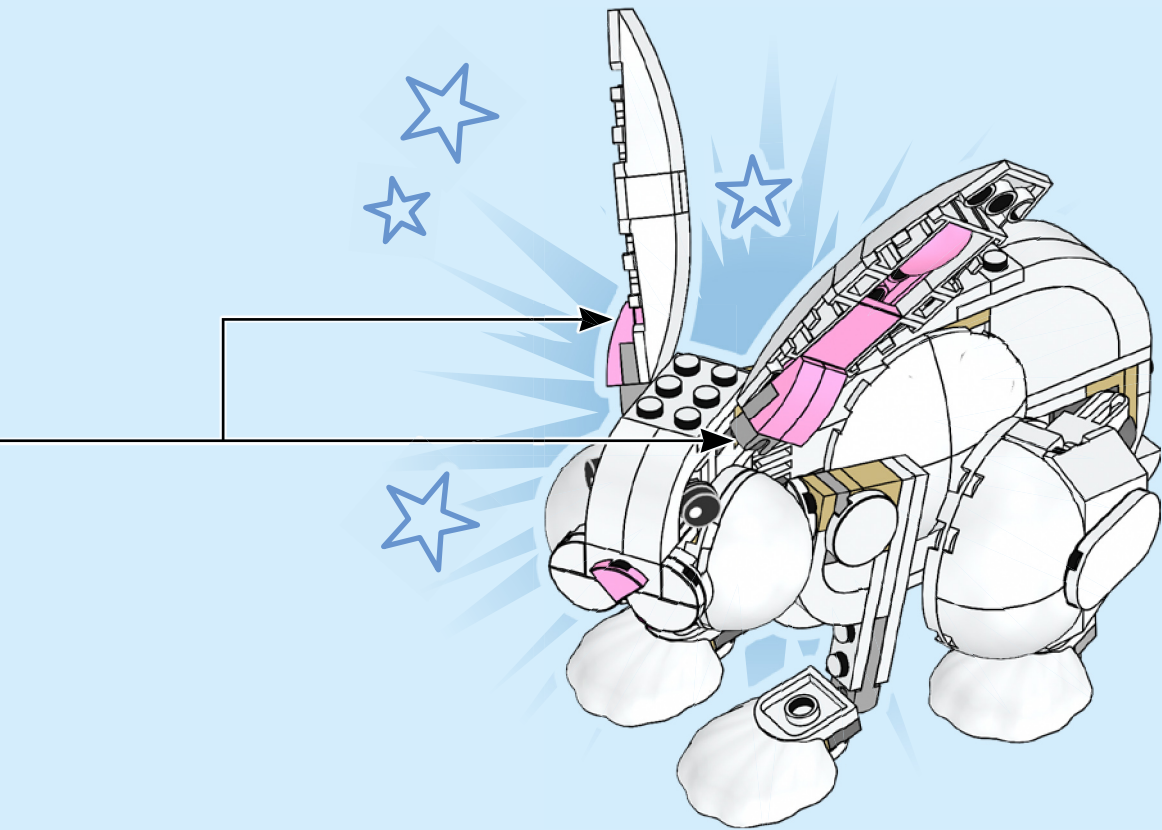

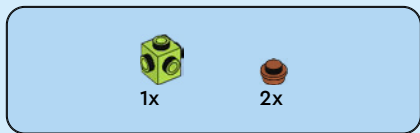

1



2

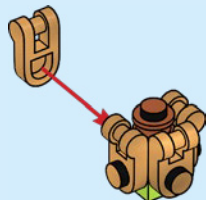

3

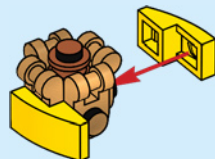



4

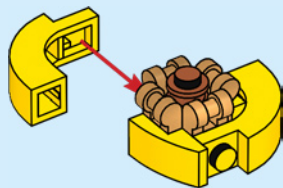

5

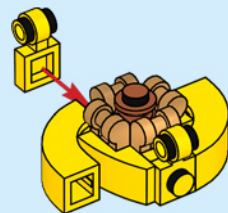



6

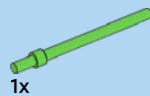
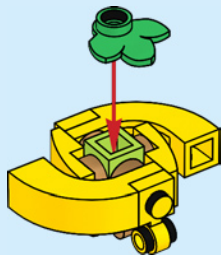
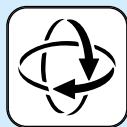

7

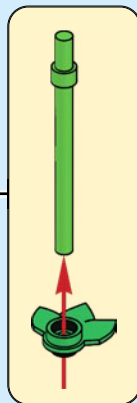
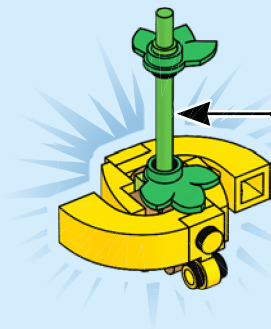

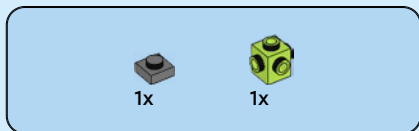
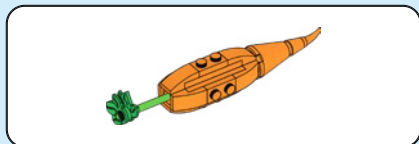

1

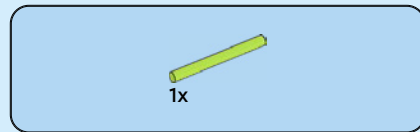

2

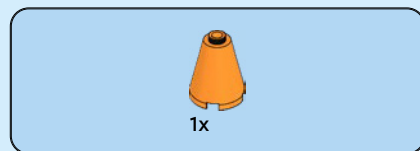

3





1x



1x

4



2x



1x

5



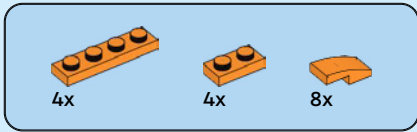

6

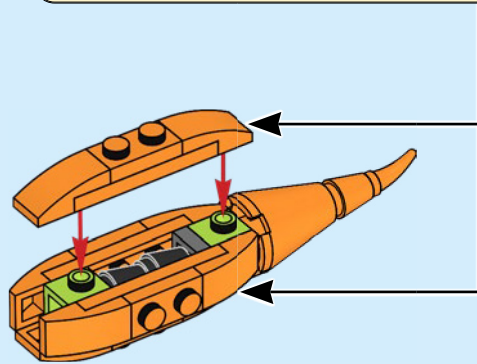
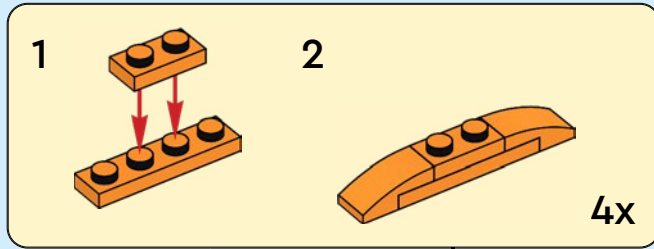

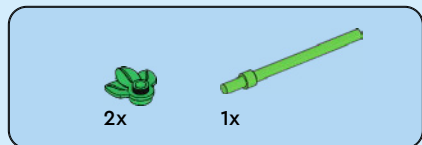

7

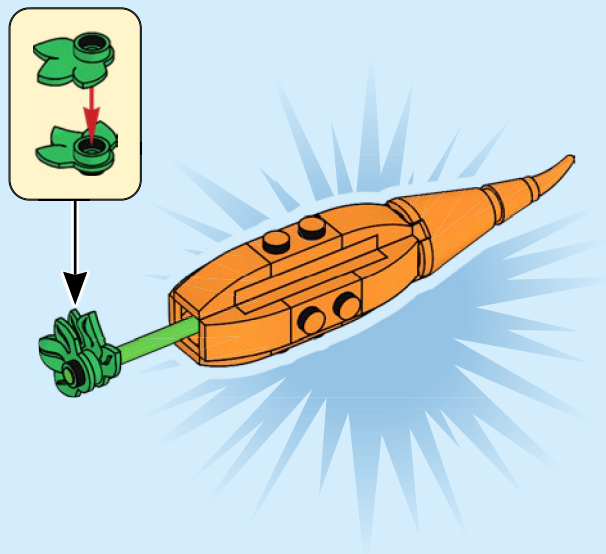

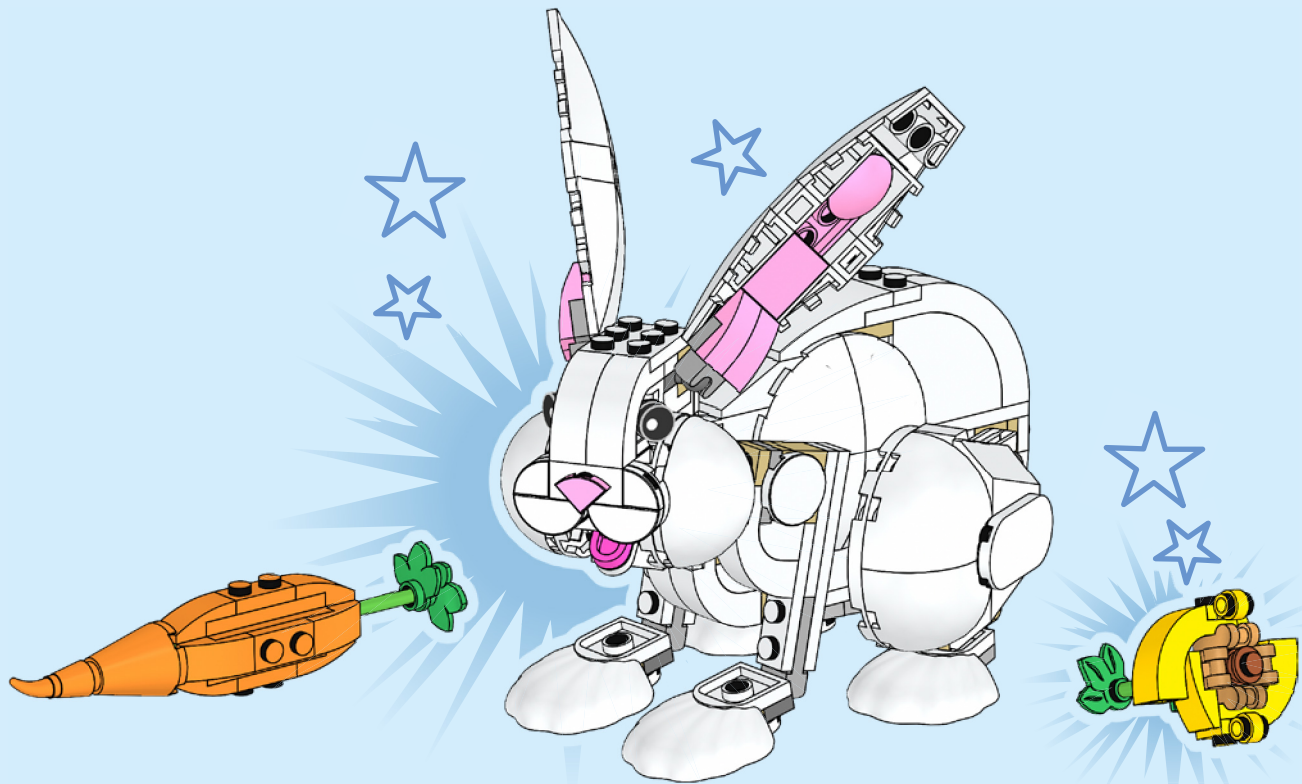

YOU COULD **WIN**



Scan this QR code or go to **LEGO.COM/PRODUCTFEEDBACK** and give us your short feedback about this LEGO® set for a chance to win a cool LEGO prize.

Terms and Conditions apply*

DE: Du könntest GEWINNEN. Es gelten die Teilnahmebedingungen* **FR: Tu pourrais GAGNER.** Des conditions s'appliquent* **IT: Potresti VINCERE tu.** Termini e condizioni sono applicabili* **ES: Puedes GANAR.** Aplican términos y condiciones* **PT: Poderá GANHAR.** Aplicam-se termos e condições* **JA: プレゼント付き! 利用規約が適用されます*** **ZH: 轻松获奖. 条款和条件适用*** **KO: 상품의 주인이 되어보세요. 소정의 약관이 적용됩니다*** **RU: Вы можете ВЫИГРАТЬ.** Действуют положения и условия* **PL: Szansa na WYGRANĄ.** Obowiązują warunki korzystania* **CS: Máte šanci VYHRÁT.** Platí všeobecné smluvní podmínky* **SK: Máte šancu VYHRAŤ.** Platia všeobecné zmluvné podmienky* **HU: TE IS NYERHETSZ.** Felhasználási feltételek érvényesek* **RO: Ai putea CÂȘTIGA.** Se aplică termenii și condițiile* **BG: Можете да СПЕЧЕЛИТЕ.** Има определени правила и условия* **LV: Tu vari LAIMĒT.** Ir spēkā noteikumi un nosacījumi.* **ET: Sul on võimalus VÕITA.** Kehtivad tingimused* **LT: Jūs galite LAIMĖTI.** Taikomos sąlygos*
*LEGO.com/productfeedback-terms