





## WE'RE MAKING OUR PACKAGING MORE SUSTAINABLE

We're transitioning from single-use plastic to paper-based packaging. As we progress, you may find a mix of paper and plastic in our boxes.

## NOUS RENDONS NOS EMBALLAGES PLUS DURABLES

Nous passons des emballages en plastique à usage unique aux emballages à base de papier. Durant la transition, vous pourriez trouver un mélange de papier et de plastique dans nos boîtes.

## QUEREMOS HACER MÁS SUSTENTABLES NUESTROS MATERIALES DE EMBALAJE

Estamos cambiando las bolsas de plástico desechables por bolsas con base de papel. Conforme avanzamos en este propósito, puedes encontrar una mezcla de papel y de plástico en nuestras cajas.

[LEGO.com/sustainable-packaging](https://www.lego.com/sustainable-packaging)



# LEGO® VIP

- 1.** SIGN UP  
INSCRIVEZ-VOUS  
REGÍSTRATE

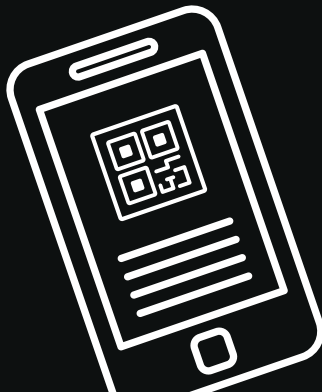

- 2.** EARN POINTS  
FOR PURCHASES  
GAGNEZ DES POINTS  
POUR VOS ACHATS  
GANA PUNTOS POR  
TUS COMPRAS

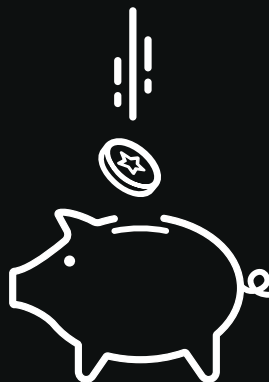

- 3.** REDEEM POINTS FOR REWARDS, EXPERIENCES,  
DISCOUNTS & MORE  
ÉCHANGEZ DES POINTS CONTRE DES RÉCOMPENSES,  
DES EXPÉRIENCES, DES RÉDUCTIONS ET PLUS ENCORE  
CANJEA PUNTOS POR RECOMPENSAS, EXPERIENCIAS,  
DESCUENTOS Y MUCHO MÁS

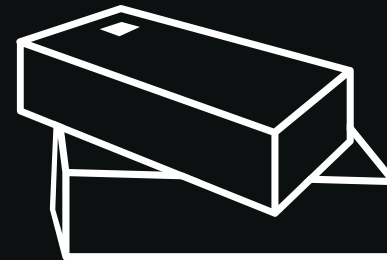
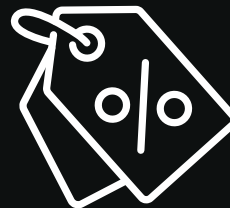



# Versatility in simplicity

**A desire to retire from the stress of urban lifestyles. A dream of an idyllic vacation retreat. An attractive remote office. A conscious choice to reduce CO<sub>2</sub> footprints. A chance to put your unique creative spin on a modern classic. These are just a few of the reasons why A-Frame cabins, and small living, are making a huge comeback.**

The origin of A-shaped living and storage spaces can be traced back centuries, with roots in Europe as well as China and the South Pacific. The modern A-Frame cabin we know today had its initial heyday in the 1950s to 1970s. In the US and Europe especially, a booming post-WWII economy allowed more families to enjoy new luxuries, big and small, and the A-Frame cabin was an attractive, inexpensive way to invest in a second home away from the cities. Architects experimented with optimizing the limited square footage and created building kits with assembly instructions to help new owners build and modify their cozy new homes to their needs, styles and environments. As international travel became more readily accessible in the late 1970s, the market for summer houses and country living faded. For the next decades, while the occasional A-Frames popped up as eye-catching local shops, the vacation home model was largely considered an outdated mid-century curiosity.

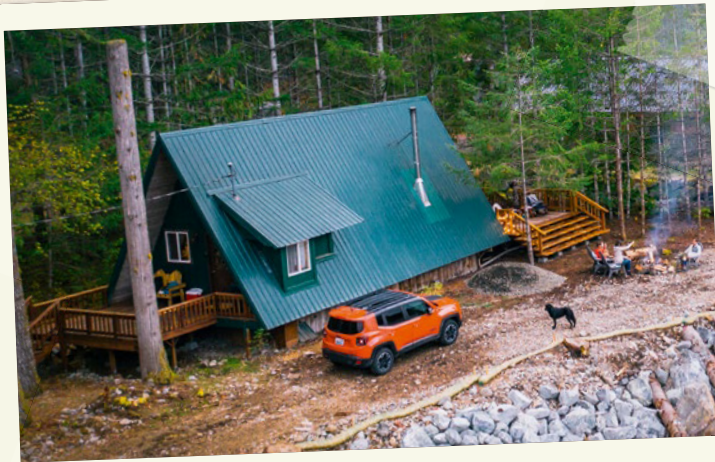

In the 2020s, the urge to return to this nostalgic way of life springs from different needs, as a natural extension of a global trend of scaling back on consumerism and embracing more individual and sustainable ways of living. The allure and benefits of the A-Frame cabin make it an obvious candidate for a triumphant revival for our age, with room for creativity and versatility in all its simplicity.





## La polyvalence en toute simplicité

Un désir de s'éloigner des contraintes de la vie urbaine. Le rêve d'un lieu de vacances idyllique. Un bureau à distance attrayant. Un choix conscient pour réduire l'empreinte du CO<sub>2</sub>. L'occasion d'apporter votre touche créative unique à un classique moderne. Ce ne sont là que quelques-unes des raisons pour lesquelles les chalets en A et les petites habitations font un retour en force.

L'origine des espaces de vie et de rangement en forme de A remonte à plusieurs siècles, avec des racines en Europe, en Chine et dans le Pacifique Sud. Le chalet en A moderne que nous connaissons aujourd'hui a connu son apogée dans les années 1950 à 1970. Aux États-Unis et en Europe en particulier, l'économie florissante de l'après-guerre a permis à un plus grand nombre de familles de profiter de nouveaux luxes, grands et petits, et le chalet en A était un moyen attrayant et peu coûteux d'investir dans une résidence secondaire loin des villes. Les architectes tentent d'optimiser les surfaces limitées et créent des ensembles de construction avec des instructions de montage pour aider les nouveaux propriétaires à construire et à modifier leur nouvelle maison douillette en fonction de leurs besoins, de leur style et de leur environnement. Lorsque les voyages internationaux sont devenus plus accessibles à la fin des années 1970, le marché des maisons d'été et de la vie à la campagne s'est estompé. Pendant les décennies suivantes, bien que des chalets en A apparaissent occasionnellement comme des boutiques locales accrocheuses, le modèle de la maison de vacances est largement considéré comme une curiosité dépassée du milieu du siècle dernier.

Dans les années 2020, l'envie de revenir à ce mode de vie nostalgique naît de besoins différents, comme une extension naturelle d'une tendance mondiale à réduire la consommation de masse et à adopter des modes de vie plus individuels et durables. Les attrait et les avantages du chalet en A en font un candidat évident pour une renaissance triomphante de notre époque, avec une place pour la créativité et la polyvalence dans toute sa simplicité.



## La versatilité de la simplicité

Una oportunidad de tomar distancia del característico estrés del estilo de vida urbano. Un refugio idílico para tomar unas vacaciones. Una atractiva oficina remota. Una elección consciente para reducir tu huella de CO<sub>2</sub>. La posibilidad de imprimir tu singular giro creativo en un clásico de nuestros días. El hecho de representar cada una de estas cosas es una razón por la que las cabañas con estructura en A y los espacios para vivir reducidos están regresando con fuerza.

El origen de los espacios habitables con forma de A se remonta a hace siglos, con raíces en Europa y China, así como en el Pacífico sur. La cabaña con estructura en A como la conocemos hoy en día tuvo su primera época de oro entre las décadas de 1950 y 1970. Especialmente en los EE. UU. y Europa, el auge económico que vino después de la Segunda Guerra Mundial permitió a más familias disfrutar de nuevos lujos, tanto grandes como pequeños, y la cabaña con estructura en A se convirtió en una forma atractiva de tener una casa fuera de las ciudades sin invertir demasiado dinero. Los arquitectos experimentaron con la optimización de la superficie limitada y crearon kits de construcción con instrucciones para ayudar a los nuevos propietarios a edificar y modificar sus nuevos y acogedores hogares de acuerdo con sus necesidades, estilos y entornos. Los viajes internacionales se volvieron mucho más accesibles hacia finales de la década de 1970 y, como consecuencia de este hecho, el mercado de las casas de campo y para vacacionar se contrajo notablemente. Durante las décadas siguientes,

si bien en las ciudades aparecieron algunos establecimientos edificados con estructura en A para hacerlos más atractivos y cercanos con el público, las verdaderas casas para vacacionar se convirtieron en curiosidades de mediados del siglo XX bastante pasadas de moda.

La década de 2020 vio surgir una premura por regresar a ese nostálgico modo de vivir con origen en diversas necesidades como una extensión natural de la tendencia global por reducir el consumismo y adoptar modos de vida más individuales y sostenibles.

El encanto y las ventajas que ofrece una cabaña con estructura en A la convierten en una candidata indiscutible para un regreso triunfante en nuestros días, con el espacio para la creatividad y la versatilidad que solo son posibles mediante la simplicidad.





## Meet the fan designer

Andrea Lattanzio (LEGO® Ideas name Norton74) lives in Milan, Italy. He started playing with his older brother's LEGO Technic™ and LEGO Classic Space sets as a child and, as an adult, he rediscovered his passion for building: "To me, LEGO bricks are a medium to express my creativity and ideas. It's like playing music or painting a picture; building is an art form. Over the past decade, it has definitively become a big part of my life."



A few years ago, Andrea started creating a series of rural houses, and he considers his A-Frame Cabin the pinnacle of this series:

"If you live a hectic life full of commitments and deadlines in a big city, it can feel quite alienating at times. Over the years, I've felt a growing need to live in a more natural and peaceful way without worrying about what 'I have to do today'. To me, the A-Frame Cabin represents a lifestyle truer and closer to nature. Not only because they're often built in the woods, but the

**"If I can't live in a real A-Frame cabin for now, then I'm building one with LEGO bricks."**

main feature of this peculiar house is also its practicality. Two roofs as walls, a small terrace, and a multifunctional interior space. That's it. It's largely utilitarian, an easy way to enclose space with materials at hand as a form of shelter, for either human or animal occupation or for storage. It requires fewer materials and less labor to build than a full-size home. Its double-height living space makes it feel spacious and stylish, and it invites closeness. It's all about rediscovering the essence of simple things and true values by eliminating excess."

## Rencontre avec le concepteur amateur

Andrea Lattanzio (pseudo LEGO® Ideas : Norton74) vit à Milan, en Italie. Il a commencé à jouer avec les ensembles LEGO Technic™ et LEGO Classic de l'espace de son frère aîné lorsqu'il était enfant et, à l'âge adulte, il a redécouvert sa passion pour la construction :

« Pour moi, les briques LEGO sont un moyen d'exprimer ma créativité et mes idées. C'est comme jouer de la musique ou peindre un tableau; la construction est une forme d'art. Au cours de la dernière décennie, c'est définitivement devenu une grande partie de ma vie. »

Il y a quelques années, Andrea a commencé à créer une série de maisons rurales, et il considère son chalet en A comme l'apogée de cette série :

« Si vous vivez une vie trépidante, pleine d'engagements et de délais, dans une grande ville, cela peut parfois sembler assez aliénant. Au fil des ans, j'ai ressenti un

**« Si je ne peux pas vivre dans un vrai chalet en A pour le moment, alors j'en construirai un avec des briques LEGO. »**

besoin croissant de vivre de manière plus naturelle et plus paisible, sans me soucier de ce que je dois faire aujourd'hui. Pour moi, le chalet en A représente un mode de vie plus vrai et plus proche de la nature, non seulement parce qu'il est souvent construit dans les bois, mais aussi parce que la principale caractéristique

de cette maison singulière est sa fonctionnalité. Deux toits en guise de murs, une petite terrasse et un espace intérieur multifonctionnel. C'est tout. Il s'agit d'une construction largement utilitaire, un moyen facile de délimiter un espace avec des matériaux à portée de main pour faire un abri pour l'occupation humaine ou animale ou pour le stockage. Sa construction nécessite moins de matériaux et de main-d'œuvre qu'une maison de taille normale. Grâce à sa double hauteur, l'espace de vie est spacieux et élégant, et il invite à la proximité. Il s'agit de redécouvrir l'essence des choses simples et des vraies valeurs en éliminant les excès. »







## Conoce al fan diseñador

Andrea Lattanzio (apodado Norton74 en LEGO® Ideas) vive en Milán (Italia). Siendo un niño, comenzó a construir con los sets LEGO Technic™ y LEGO Classic Space de su hermano mayor. Años más tarde, en su vida adulta, redescubrió su pasión por construir: "Para mí, los bricks LEGO representan un medio para expresar mi creatividad e ideas. Es como tocar un instrumento musical o pintar un cuadro: construir es una forma de hacer arte. Es innegable que se han convertido en una parte muy importante de mi vida a lo largo de la última década".

Hace unos pocos años, Andrea comenzó a crear casas rurales, y no titubea al decir que la Cabaña en A es, en su opinión, el pináculo de la serie que estas componen: "Vivir una vida acelerada y llena de compromisos y plazos por cumplir en una gran ciudad puede hacerte sentir aislado a veces. Con el paso de los años, he sentido una creciente necesidad de vivir de un modo más natural y pacífico sin preocuparme de lo que tengo que lograr hoy. Para mí, la Cabaña en A representó un estilo de vida más auténtico y cercano a la naturaleza. No solo porque las edificaciones de este tipo se construyen

**"Si no puedo vivir en una cabaña con estructura en A por ahora, entonces construiré una con bricks LEGO".**

frecuentemente en los bosques, sino porque su principal característica es la practicidad. Un techo de dos aguas que también hace la función de paredes, una pequeña terraza y un espacio interior multifuncional. Y eso es todo. Útil a más no poder, es una manera de delimitar el espacio creando, con los materiales que hay a la mano, un refugio para ser utilizado por personas o animales, o con fines de almacenamiento. Su construcción requiere menos materiales y mano de obra que la de una casa de tamaño completo. Su doble altura la hace sentir espaciosa y le da estilo, además de propiciar la cercanía entre sus habitantes. Se trata de redescubrir la esencia de las cosas simples y los valores auténticos eliminando los excesos".



Andrea Lattanzio and his original submission  
Andrea Lattanzio et son modèle original  
Andrea Lattanzio y su propuesta original

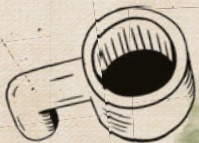





## Rencontre avec les concepteurs LEGO®

« Le modèle original d'Andrea comprenait un intérieur complet fourmillant de détails qui constituent d'excellentes amorces d'histoires et offrent au constructeur une expérience de jeu complète à 360 degrés à l'intérieur et à l'extérieur du chalet en A. Un de mes détails préférés est un micromodèle de la Cabane dans l'arbre LEGO® Ideas (21318), l'une des inspirations LEGO d'Andrea pour son modèle original. Quelle meilleure façon de se détendre dans son chalet que de jouer avec un ensemble LEGO ? »

*Justin Ramsden, concepteur de modèles LEGO Ideas*

« J'adore la vie de chalet et j'étais impatiente de maximiser tout le confort du chalet d'Andrea dans les moindres détails, des insectes et animaux mignons à la penderie chaleureuse. C'est l'une des premières fois que nous utilisons un élément de papillon décoré pour créer un petit paon de nuit, et vous pouvez trouver une autre des créations d'Andrea, le chalet bleu, dans le tableau au-dessus du lit. Vous pouvez raconter votre propre histoire : S'agit-il d'un voyage entre frères et sœurs, d'une escapade romantique ou d'une aventure entre amis ? C'est à vous de décider ! »

*Kenza Faten Statoua, graphiste LEGO Ideas*

## Meet the LEGO® designers

"Andrea's original fan submission included a complete interior crammed full of details that make for great story starters and give the builder a full 360-degree play experience both inside and around the A-Frame cabin. One of my favorite details is a micro-build of the LEGO® Ideas Tree House (21318), one of Andrea's LEGO inspirations for his original submission. What better way to relax in your cabin than to play with a LEGO set!"

*Justin Ramsden, LEGO Ideas Model Designer*

"I love cabin life and I was excited to maximize all the coziness of Andrea's cabin in every detail, from cute bugs and animals to the warm wardrobe. This is one of the first times we have used a decorated butterfly element to create an Emperor Moth, and you can find another one of Andrea's creations, Blue Cottage, in the painting above the bed. You can tell your own story: Is it a sibling trip, a romantic getaway or friends going on adventures? All up to you!"

*Kenza Faten Statoua, LEGO Ideas Graphic Designer*

« Nous avons travaillé dur pour représenter l'harmonie entre les humains et la nature que les chalets en A peuvent apporter à leur environnement; tout le monde a un chez-soi ici. Prenez le temps d'affiner vos talents de photographe, de faire du cahot, d'écrire le roman que vous avez toujours voulu publier, de vous réunir avec vos amis autour du feu ou d'observer les oiseaux. Nous voulons vraiment que vous fassiez de ce lieu votre destination idéale ! »

*Ollie Gregory, concepteur de modèles LEGO Ideas*

"We worked hard to represent the harmony between humans and nature A-Frame cabins can bring to their environment, everyone has a home here. Take time to hone your photography skills, go canoeing, write that novel you've always wanted to publish, jam with friends around the fire or go bird-spotting. We really want you to make this your perfect getaway!"

*Ollie Gregory, LEGO Ideas Model Designer*

"With my architectural background, I really got to put my understanding of structure, form, space and function to use! An advantage of an A-Frame cabin is that it provides structural support, eliminating the need for internal columns. We split the build into smaller sections and combined them to complete the wall. Lining up all the angles to allow the roof to close with minimal gaps was very satisfying."

*Woon Tze Chee, LEGO Ideas Model Designer*

« Grâce à ma formation d'architecte, j'ai vraiment pu mettre à profit ma compréhension de la structure, de la forme, de l'espace et de la fonction ! L'avantage du chalet en A est qu'il présente un support structurel, ce qui élimine le besoin de colonnes internes. Nous avons divisé la construction en petites sections et les avons combinées pour terminer le mur. L'alignement de tous les angles pour permettre au toit de se fermer avec un minimum d'espace était très satisfaisant. »

*Woon Tze Chee, concepteur de modèles LEGO Ideas*

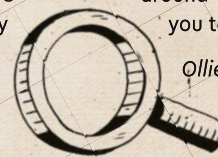





## Conoce a los diseñadores de LEGO®

"La propuesta original de Andrea incluía un completo interior repleto de detalles ideales para dar lugar a la narración de historias que ofrecían al constructor una experiencia de juego envolvente tanto adentro como afuera de la cabaña. Uno de mis detalles favoritos es un micromodelo del set LEGO® Ideas Casa del Árbol (21318), una de las fuentes LEGO en las que se inspiró Andrea para crear su diseño original. ¿Qué podría ser mejor para relajarte en tu cabaña que jugar con un set LEGO?"

*Justin Ramsden, modelista de LEGO Ideas*

"Me encanta la vida en las cabañas y me emocionaba tener la oportunidad de maximizar el confort de la propuesta de Andrea con todos los detalles, desde simpáticos bichos y animales hasta un acogedor guardarropa. Esta es una de las primeras veces que usamos un elemento decorado de una mariposa para representar un pequeño pavón. Además, encontrarán una referencia a la creación Blue Cottage, también de Andrea, en la pintura que está arriba de la cama. Esta creación te permite contar tu propia historia: ¿será sobre un viaje de hermanos o hermanas, una escapada romántica o una aventura con tu grupo de amigos? ¡Eso lo decides tú!"

*Kenza Faten Statoua, diseñadora gráfica de LEGO Ideas*



*Woon Tze, Kenza, Justin, Ollie — LEGO Ideas Designers / Concepteurs LEGO Ideas / diseñadores de LEGO Ideas*

"Trabajamos muy duro para representar la armonía entre los humanos y la naturaleza que las cabañas en A pueden aportar al entorno, porque aquí todos son bienvenidos. Dedicamos tiempo a pulir tus habilidades para la fotografía, navega en canoa, escribe la novela que siempre quisiste publicar, canta a todo pulmón con tus amigos alrededor del fuego o ve a mirar aves. ¡De verdad queremos ofrecerte la escapada perfecta!"

*Ollie Gregory, modelista de LEGO Ideas*

"Conozco de arquitectura, y este proyecto me dio la oportunidad de poner en práctica todo lo que sé sobre la estructura, la forma, el espacio y la función! Una de las ventajas de una cabaña en A es que su peculiar forma proporciona apoyo estructural sin requerir columnas interiores. Dividimos el modelo en secciones más pequeñas y las combinamos para completar el muro. Alinear todos los ángulos para hacer posible que el techo se cerrara con la mínima separación fue algo muy satisfactorio!"

*Woon Tze Chee, modelista de LEGO Ideas*



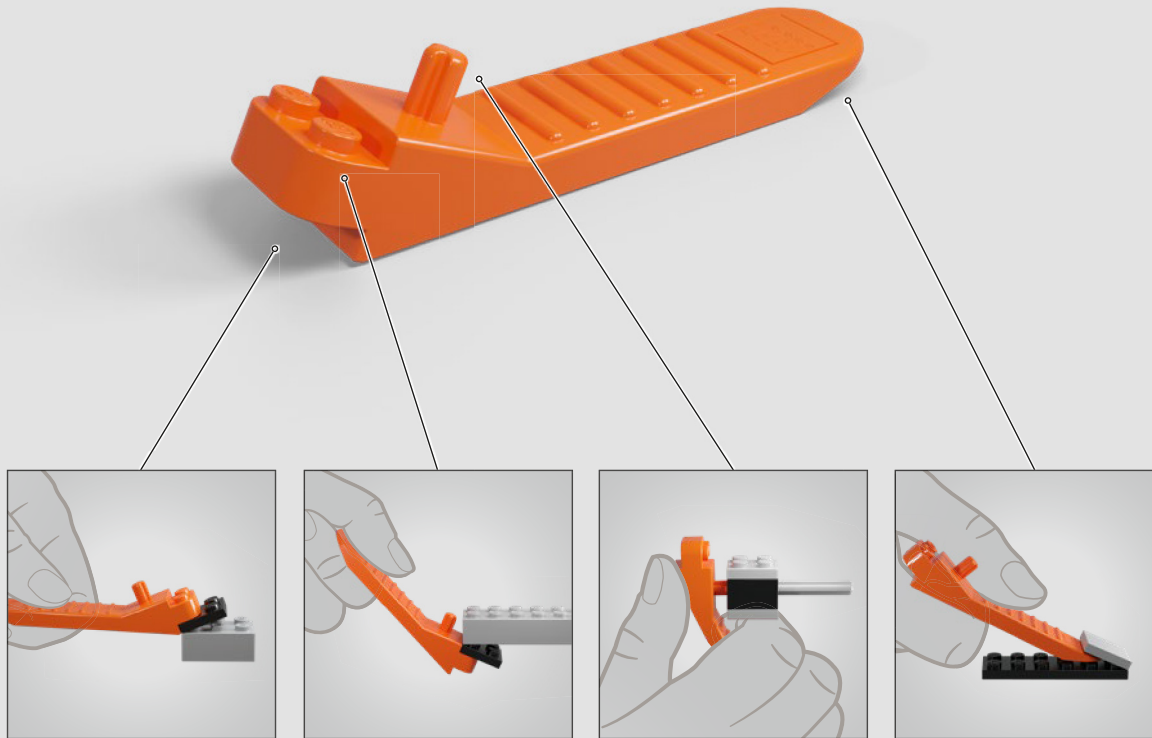



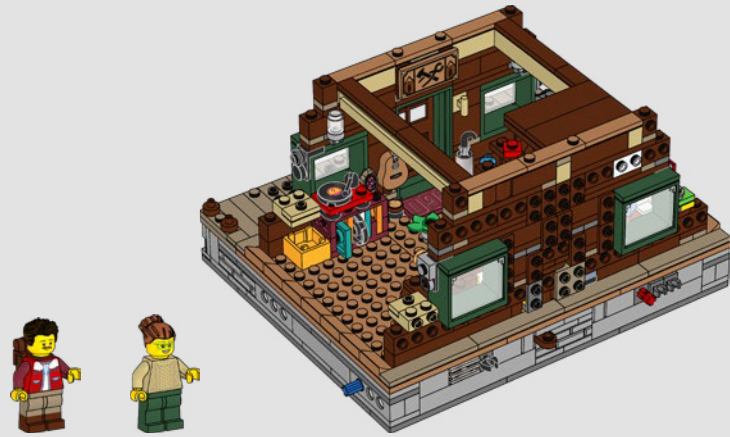







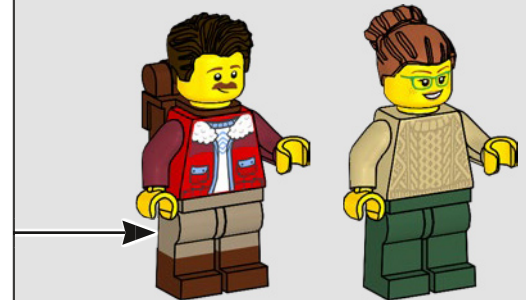
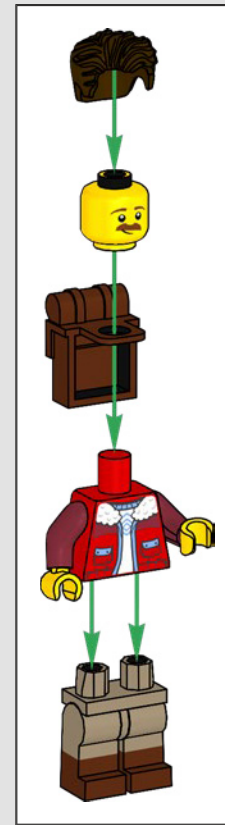
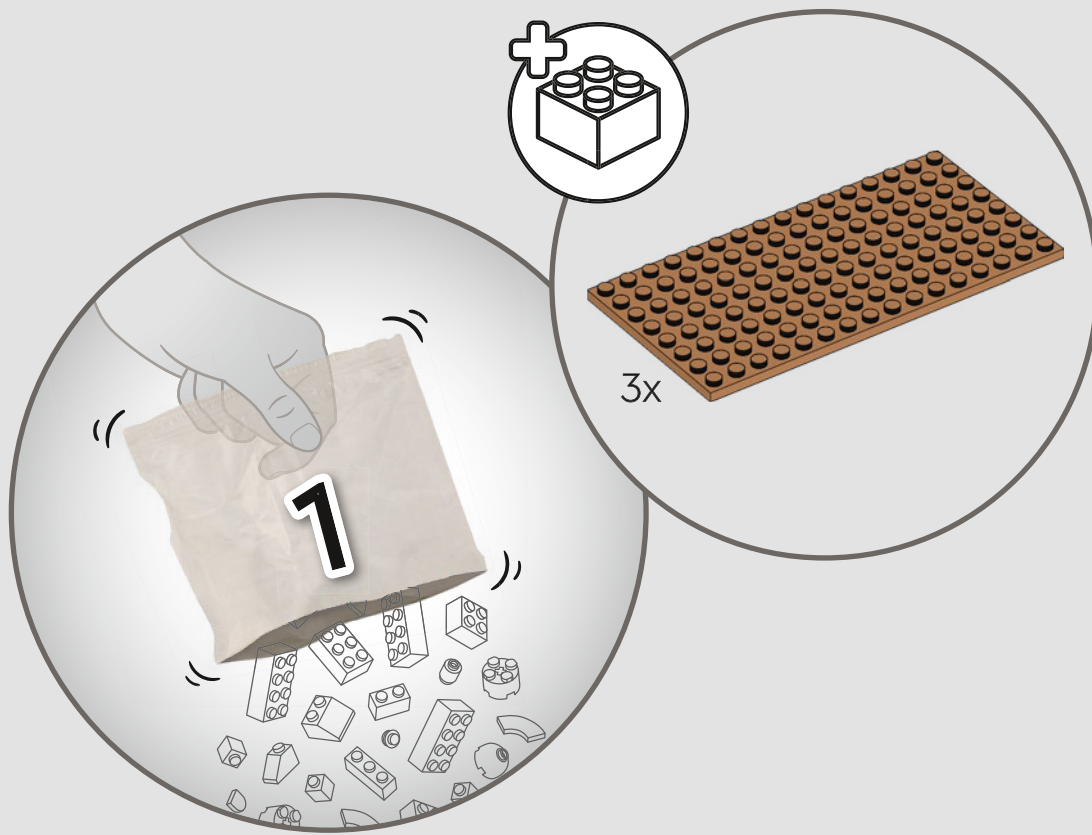



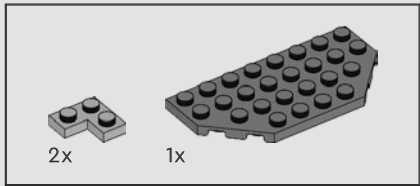
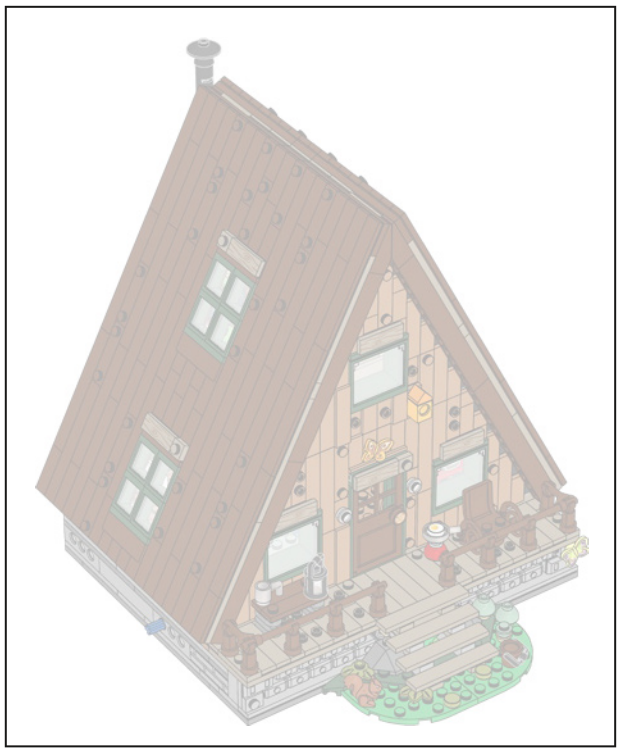

1

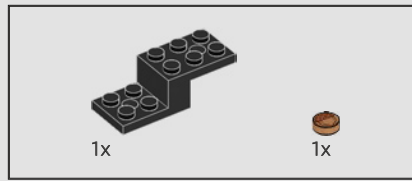
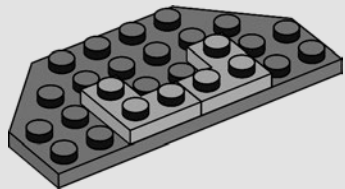

2

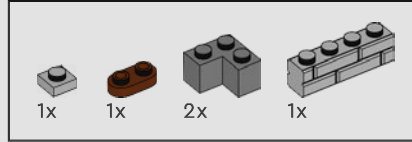
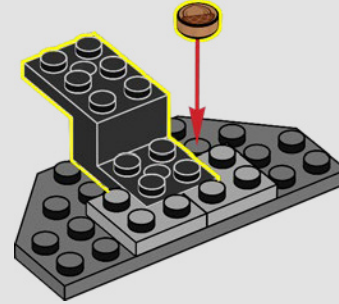

3

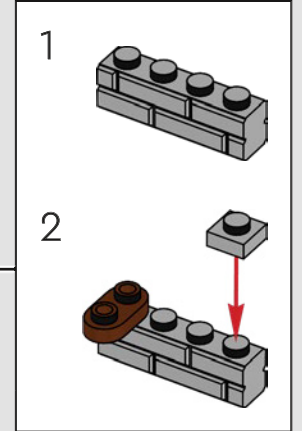
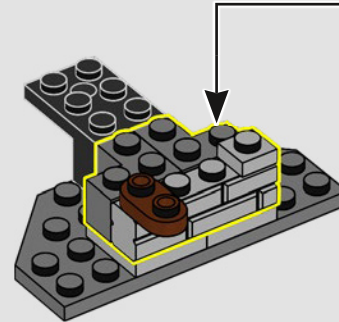



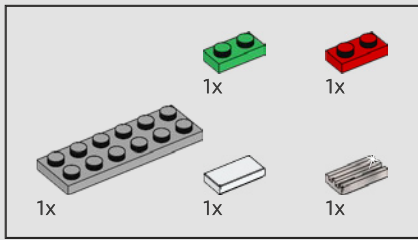

4

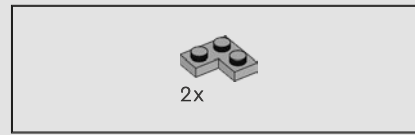
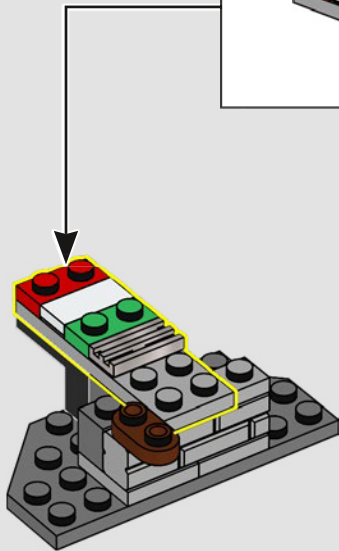
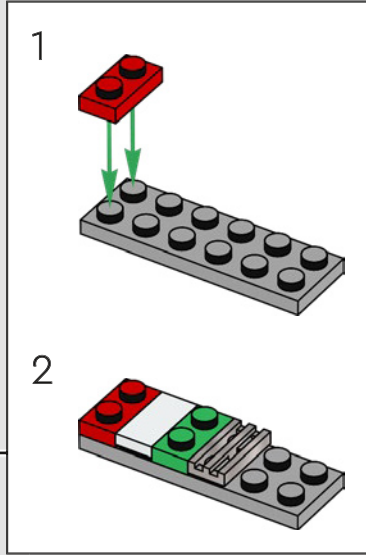

5

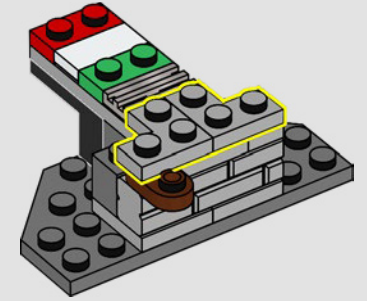

6

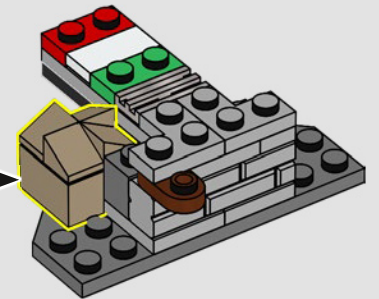
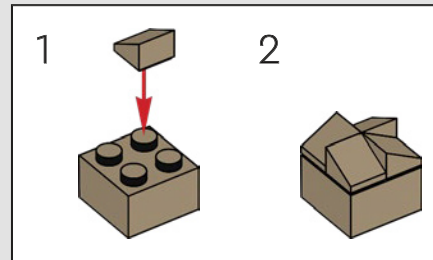



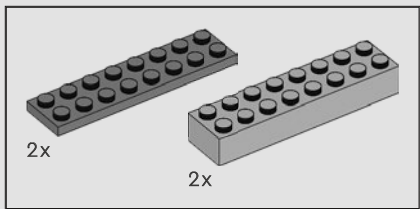

7

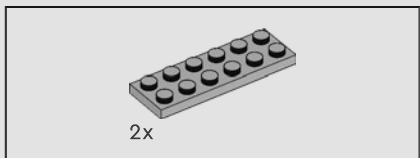
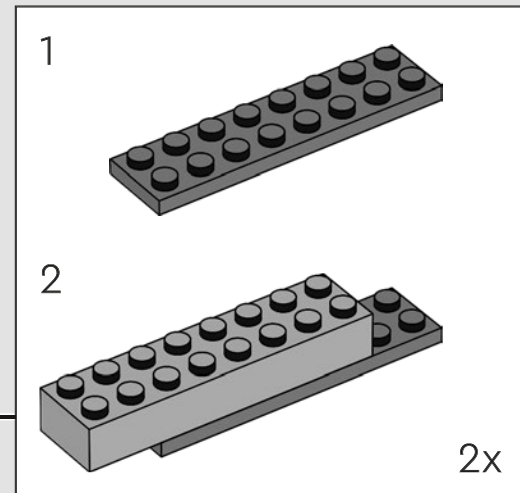
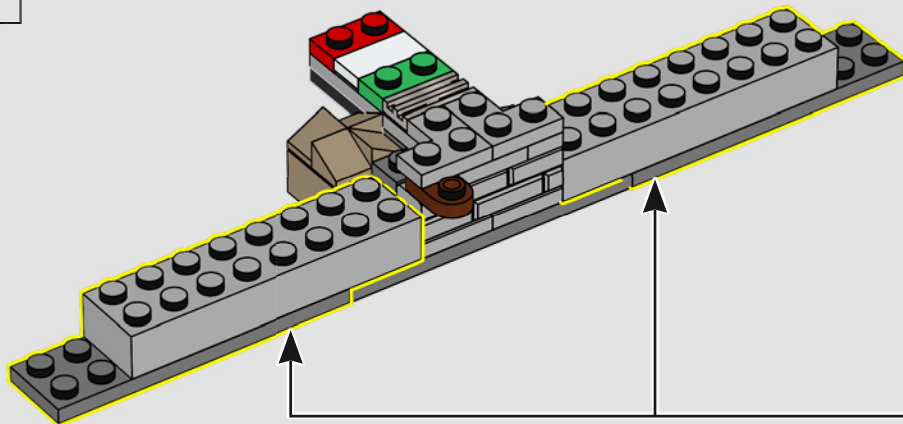

8

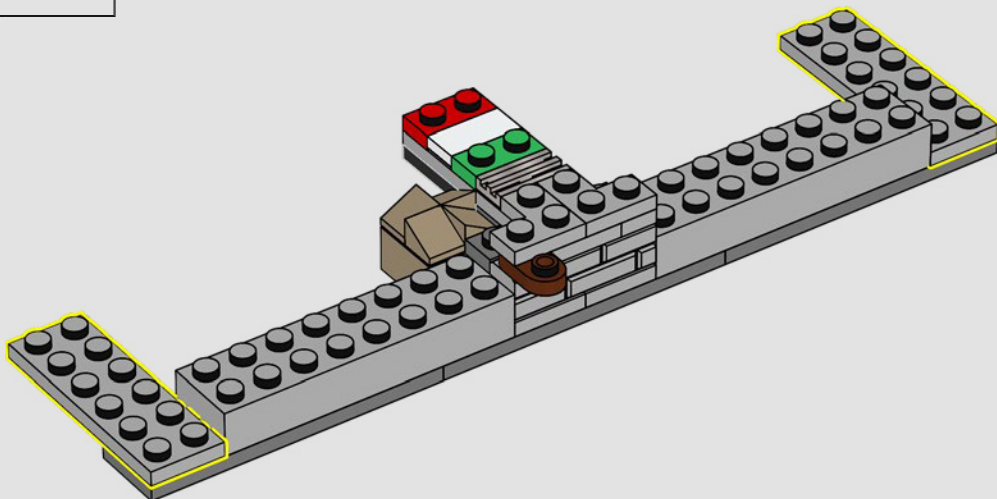



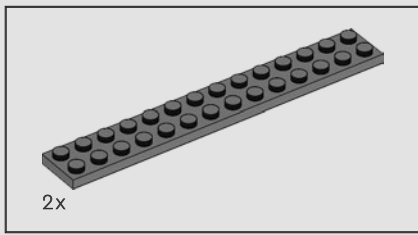

9

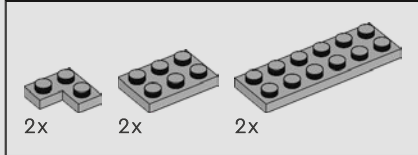
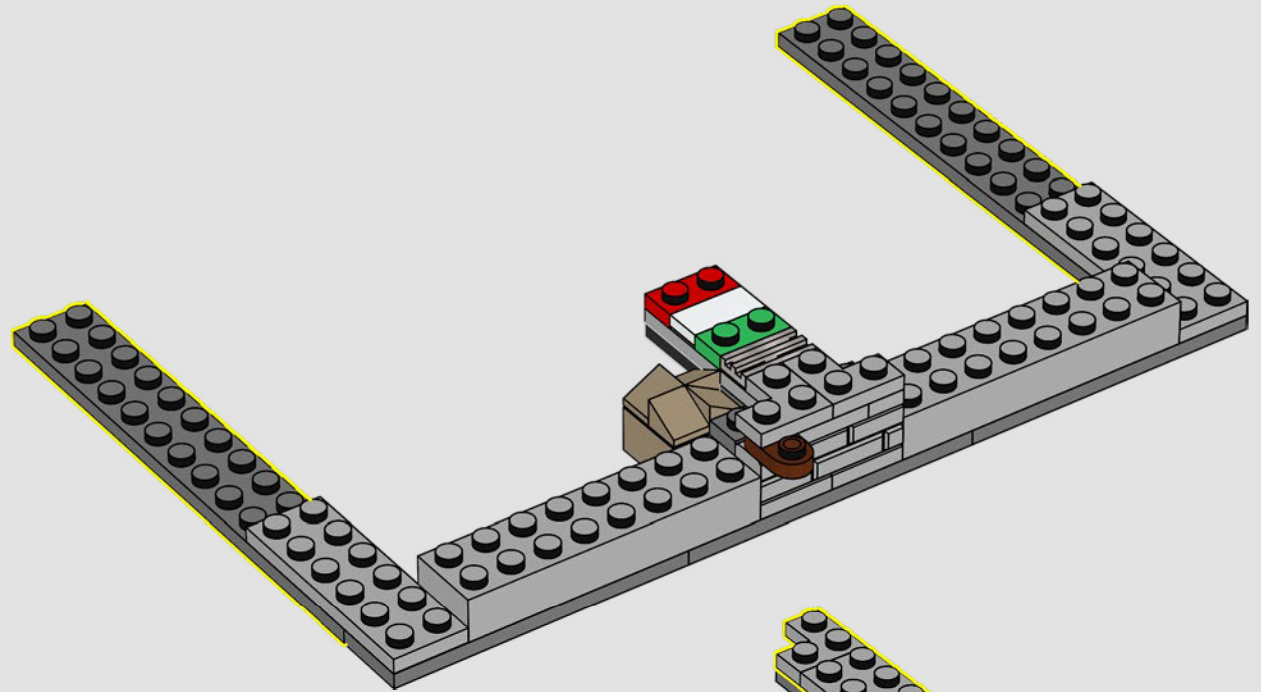

10

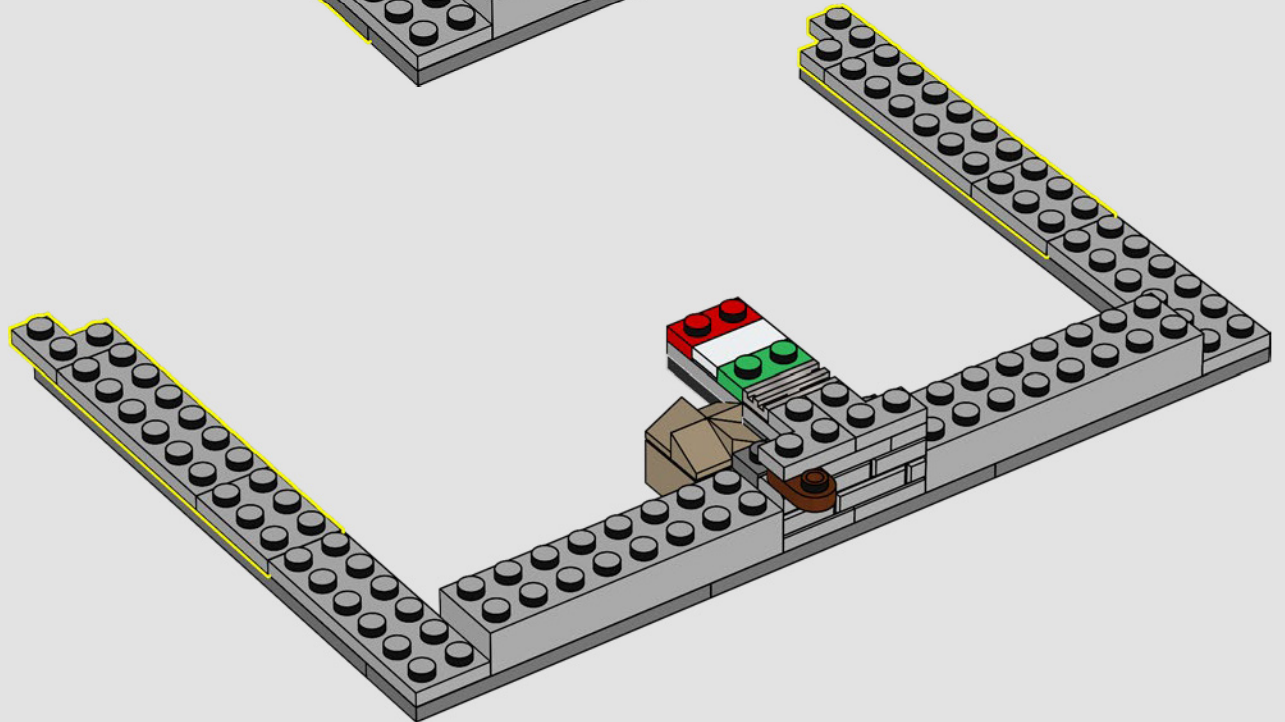



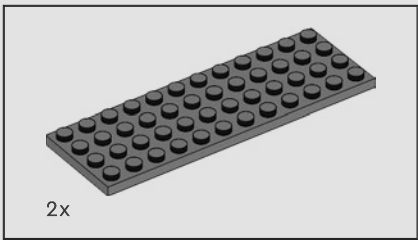

11

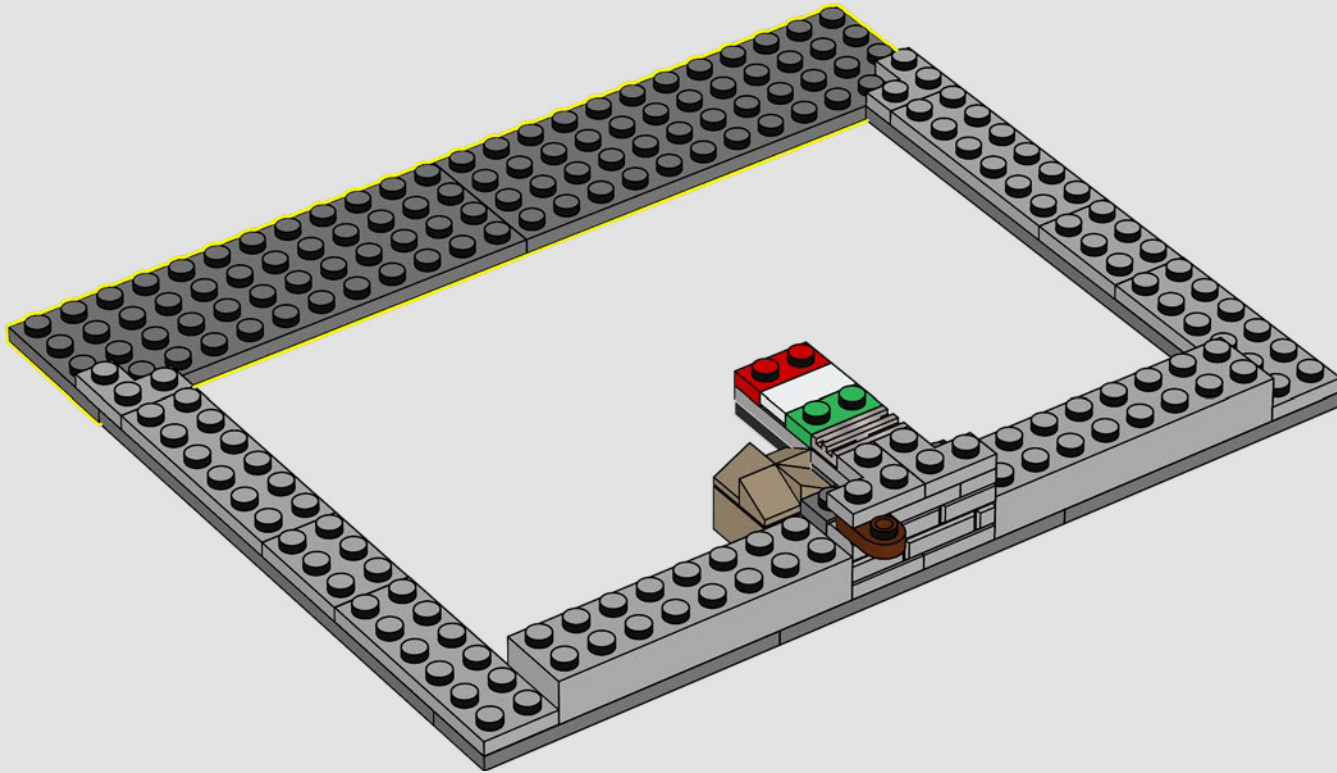



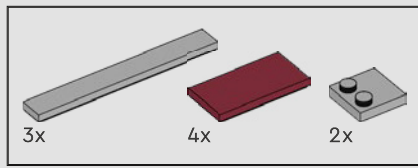

12

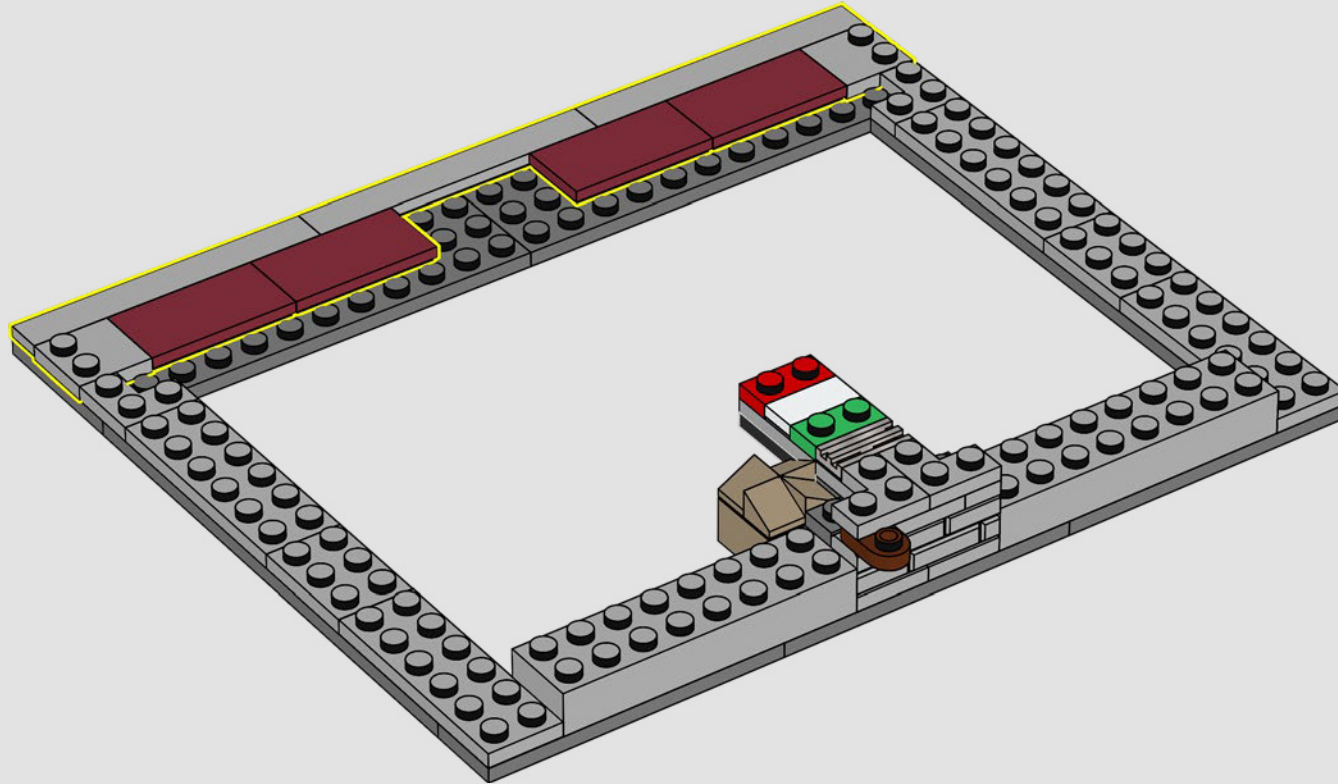



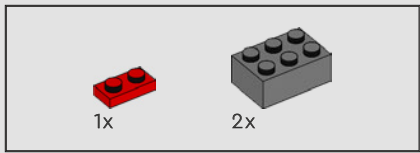

13

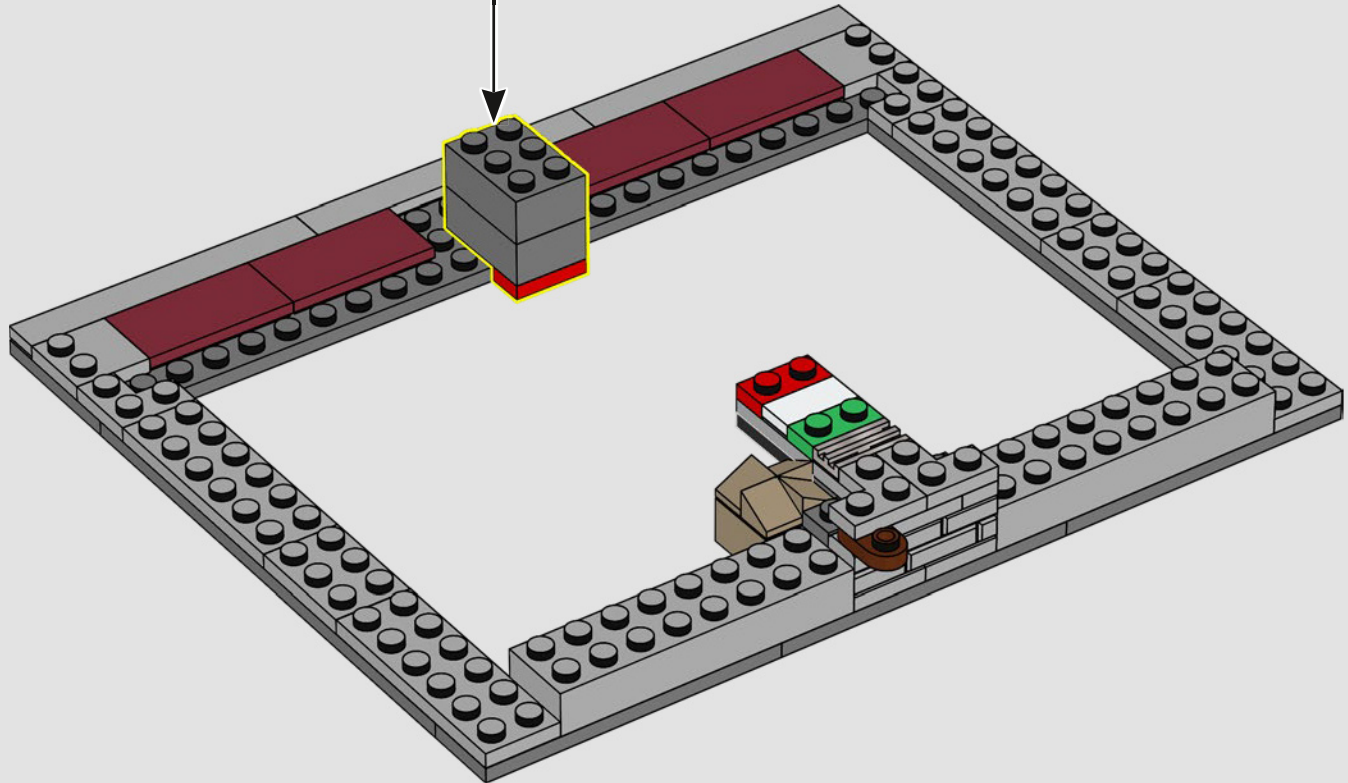
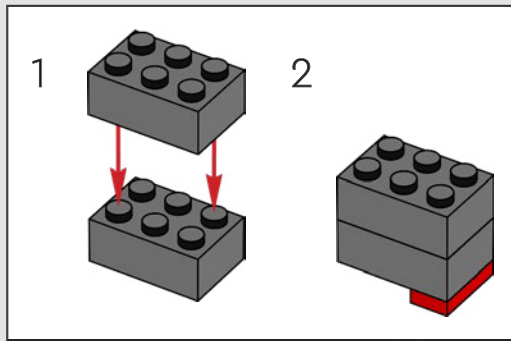



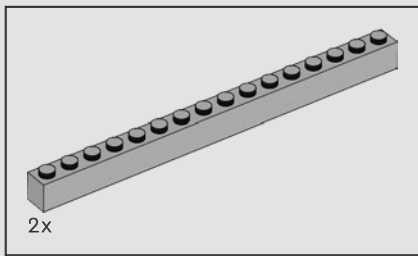

14

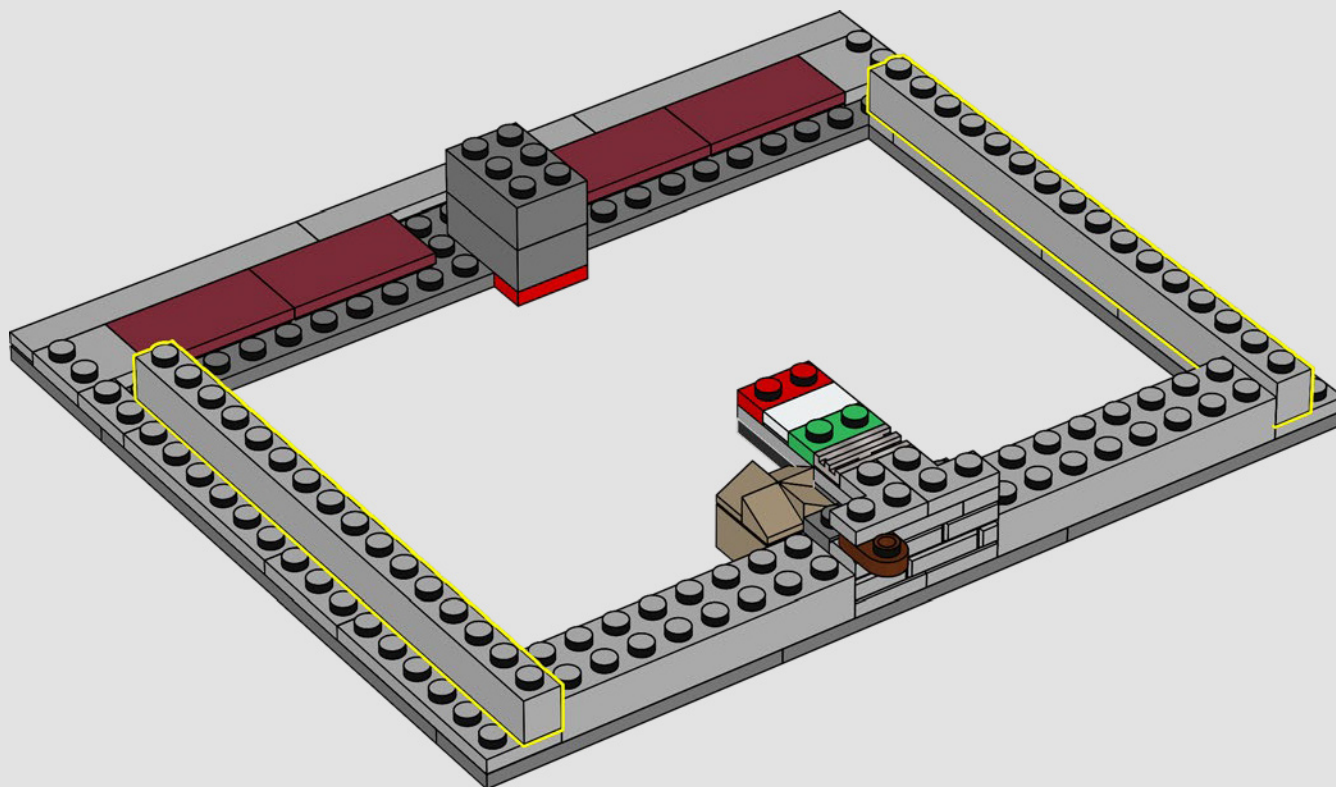

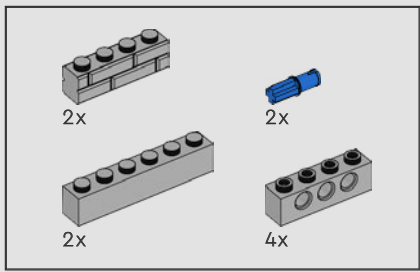

15

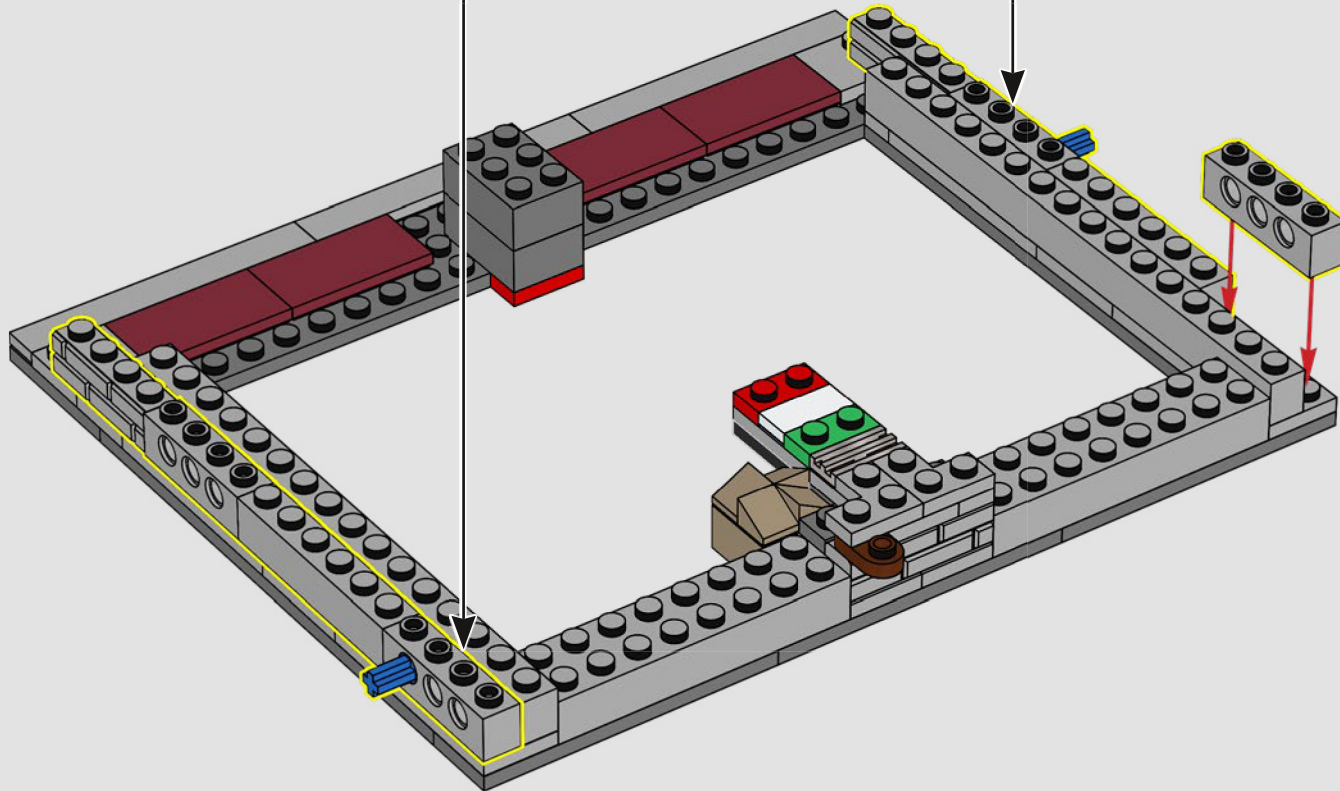
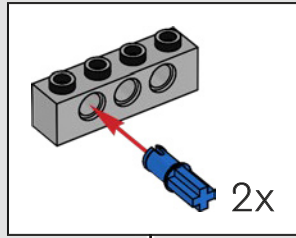



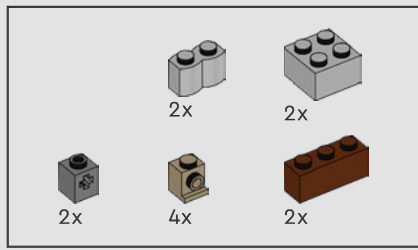

16

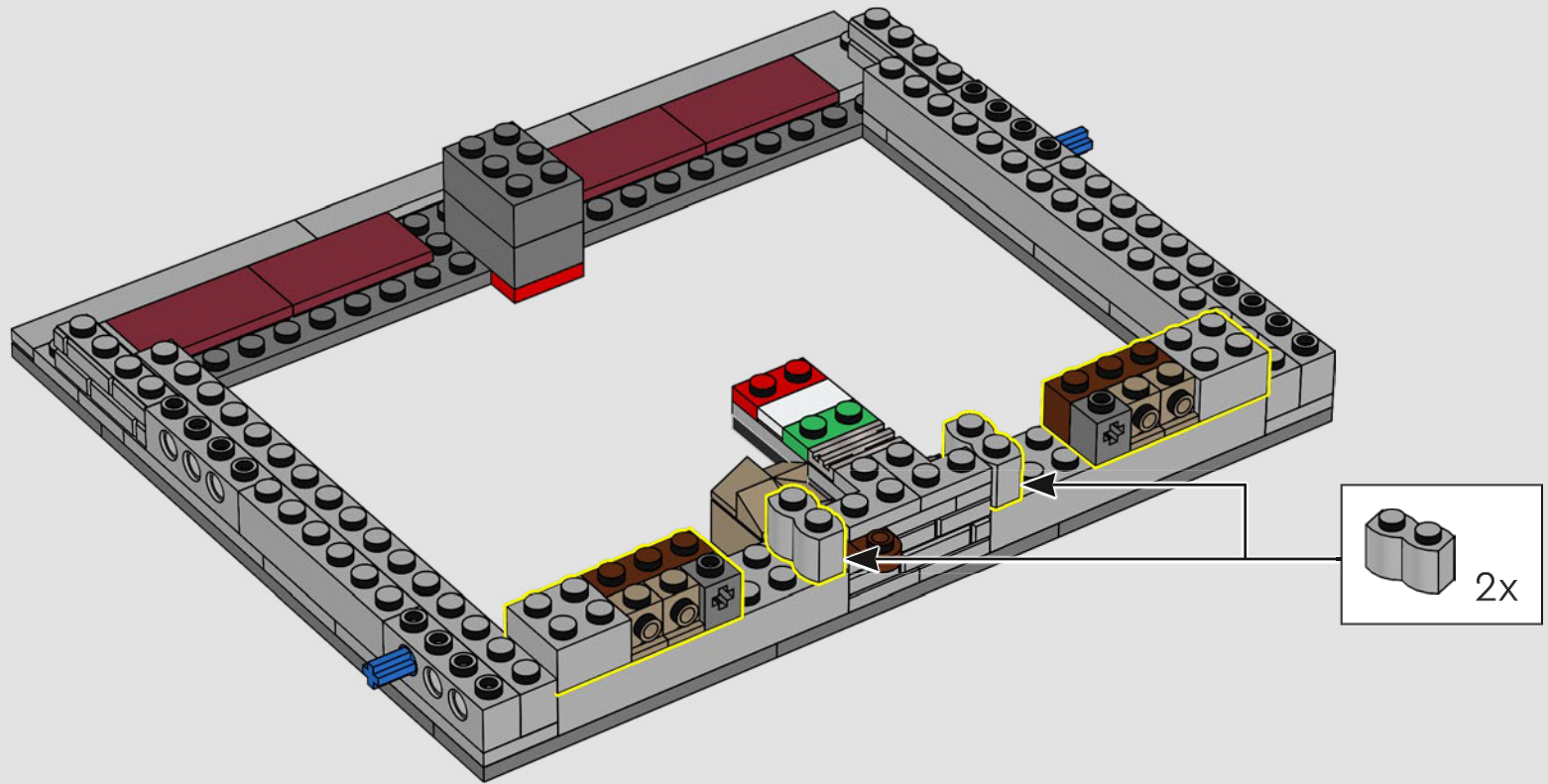

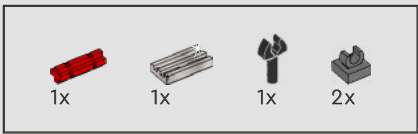

17

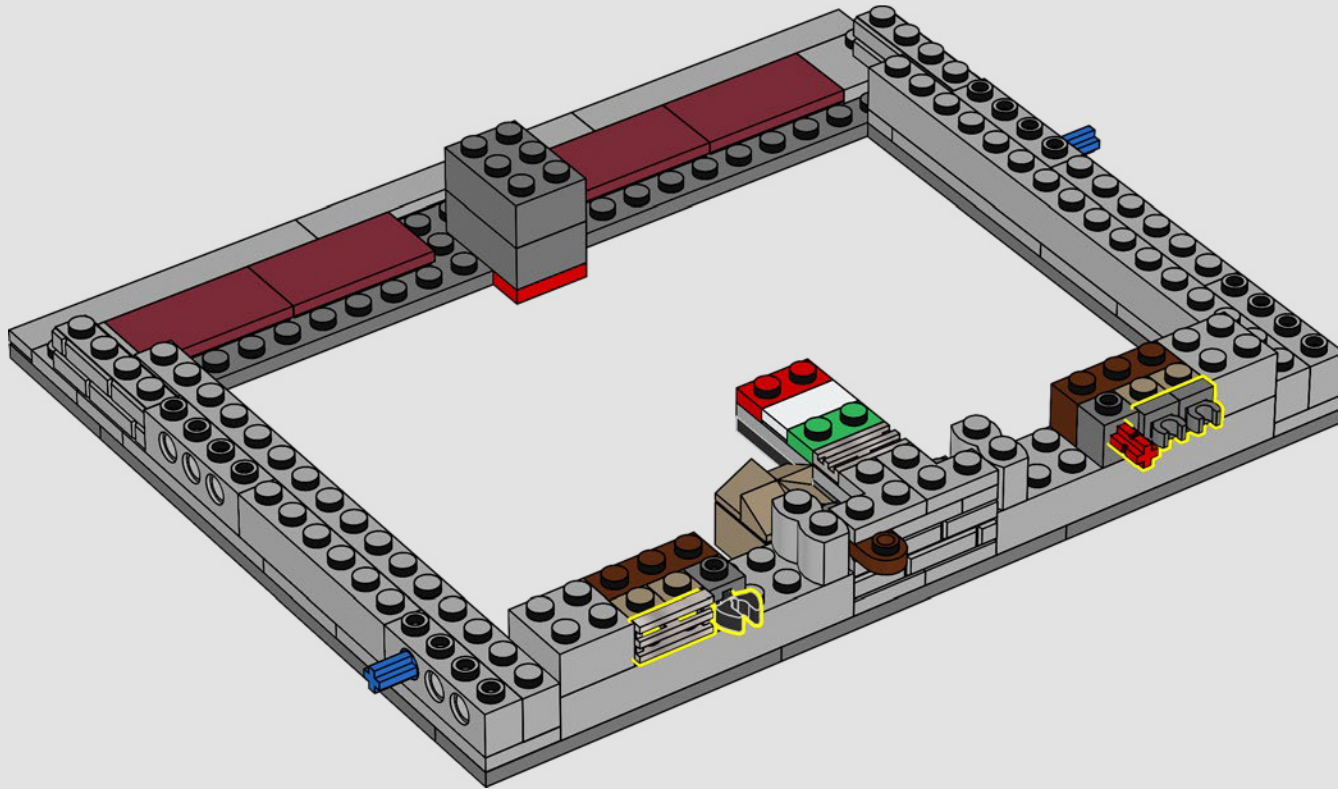



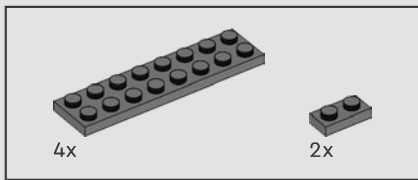

18

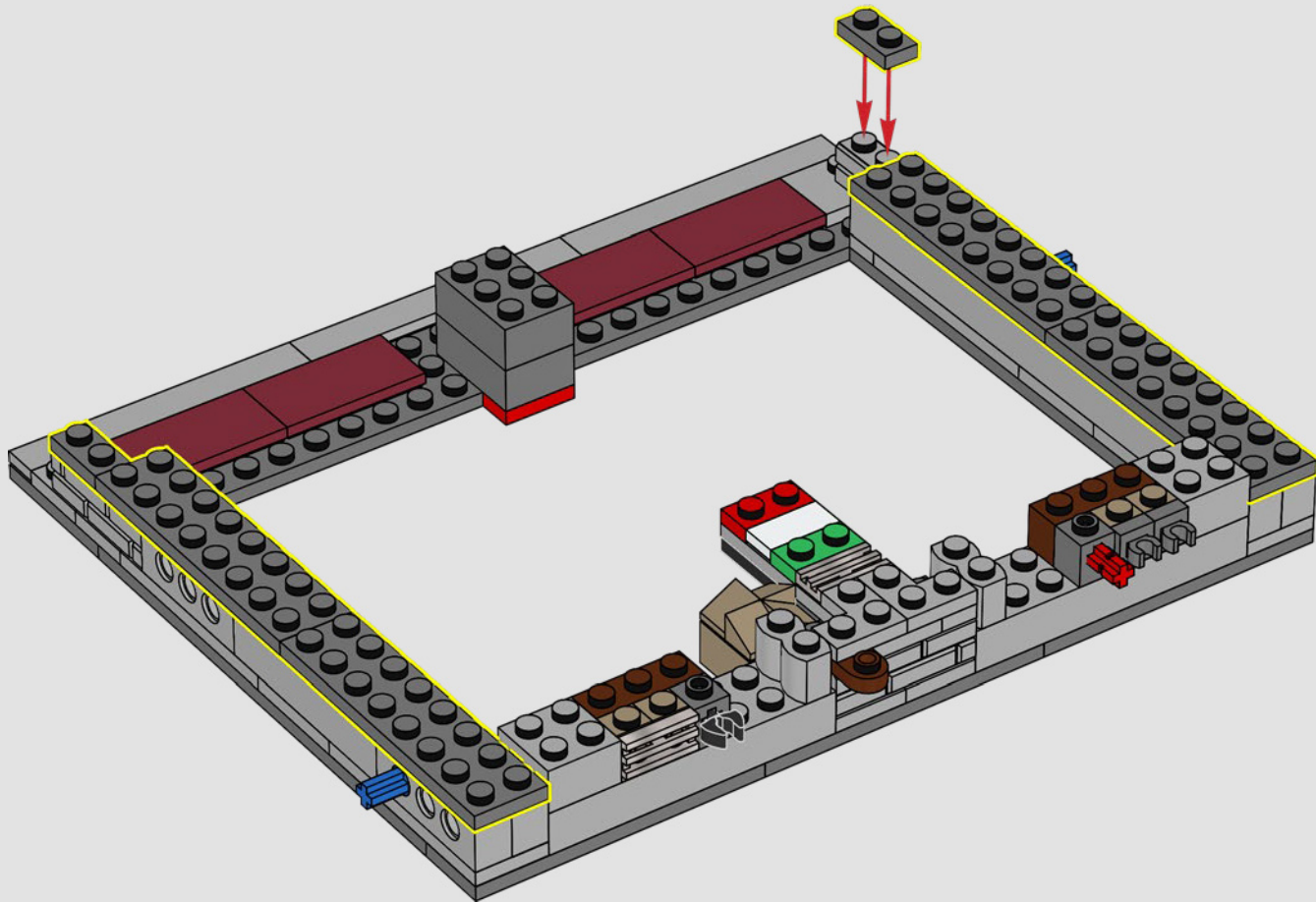

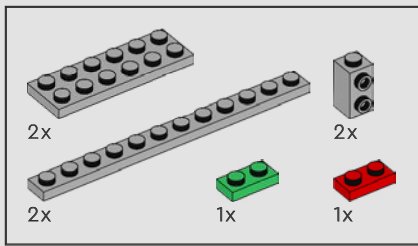

19

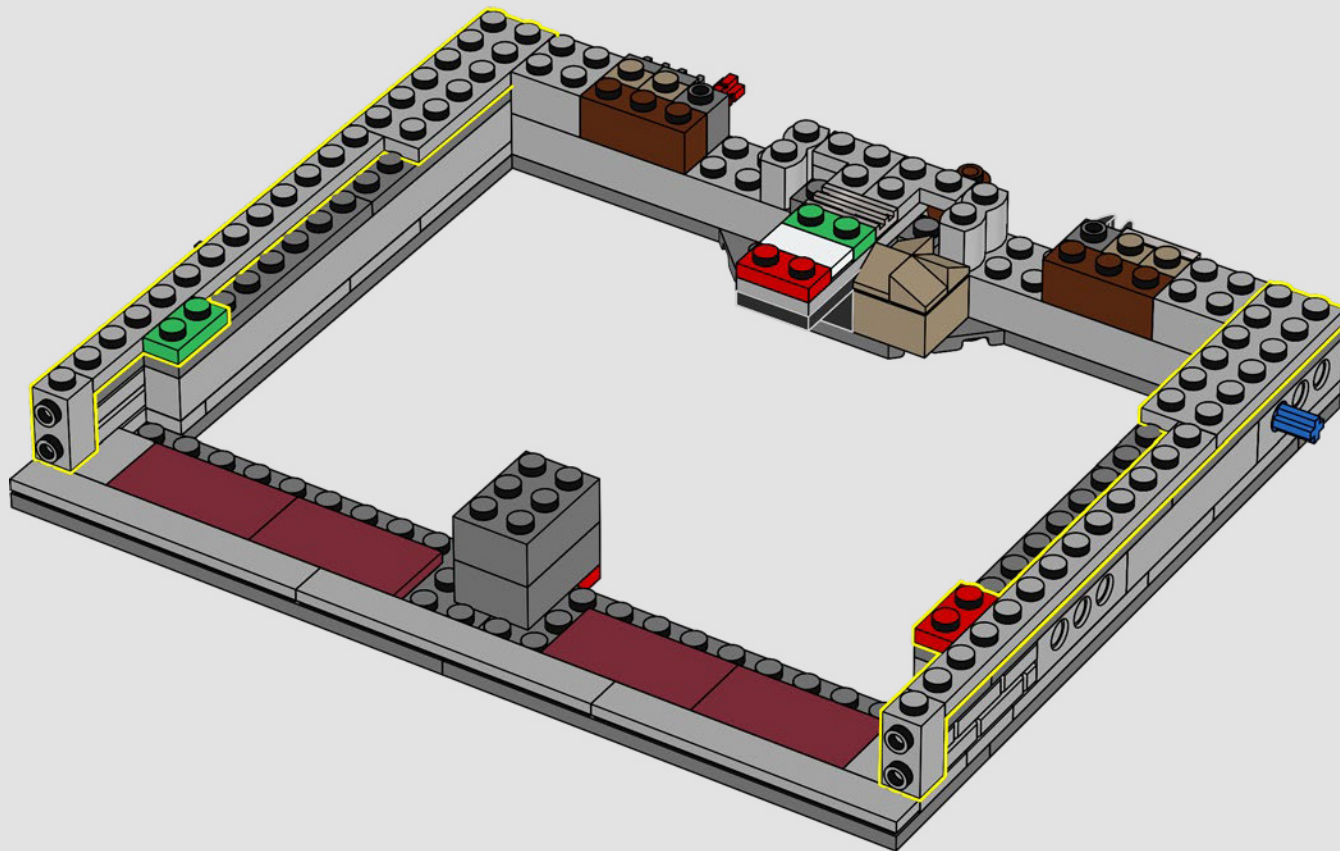



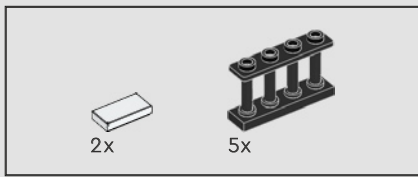

20

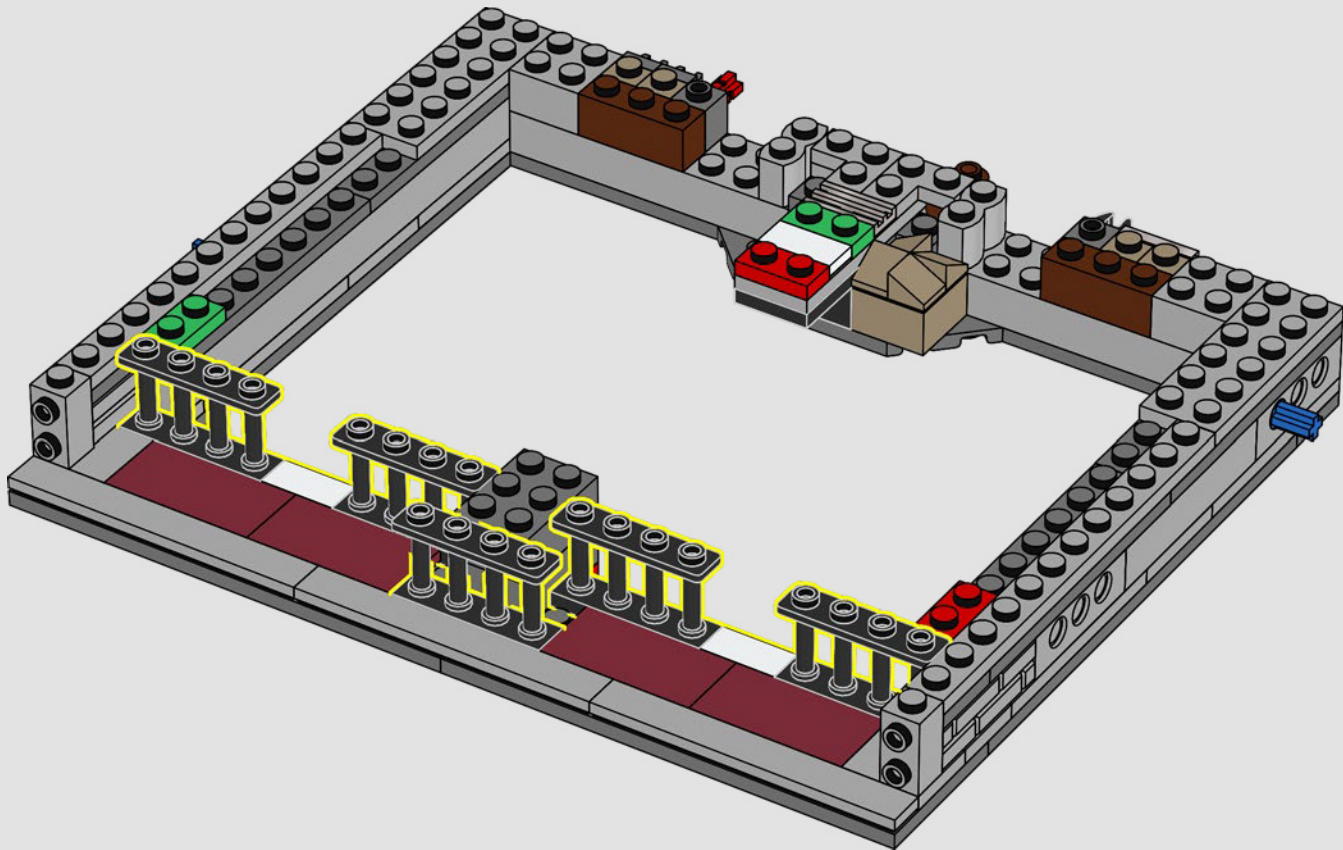

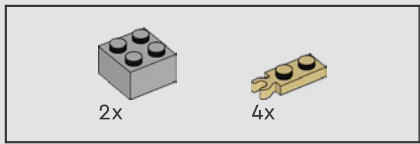

21

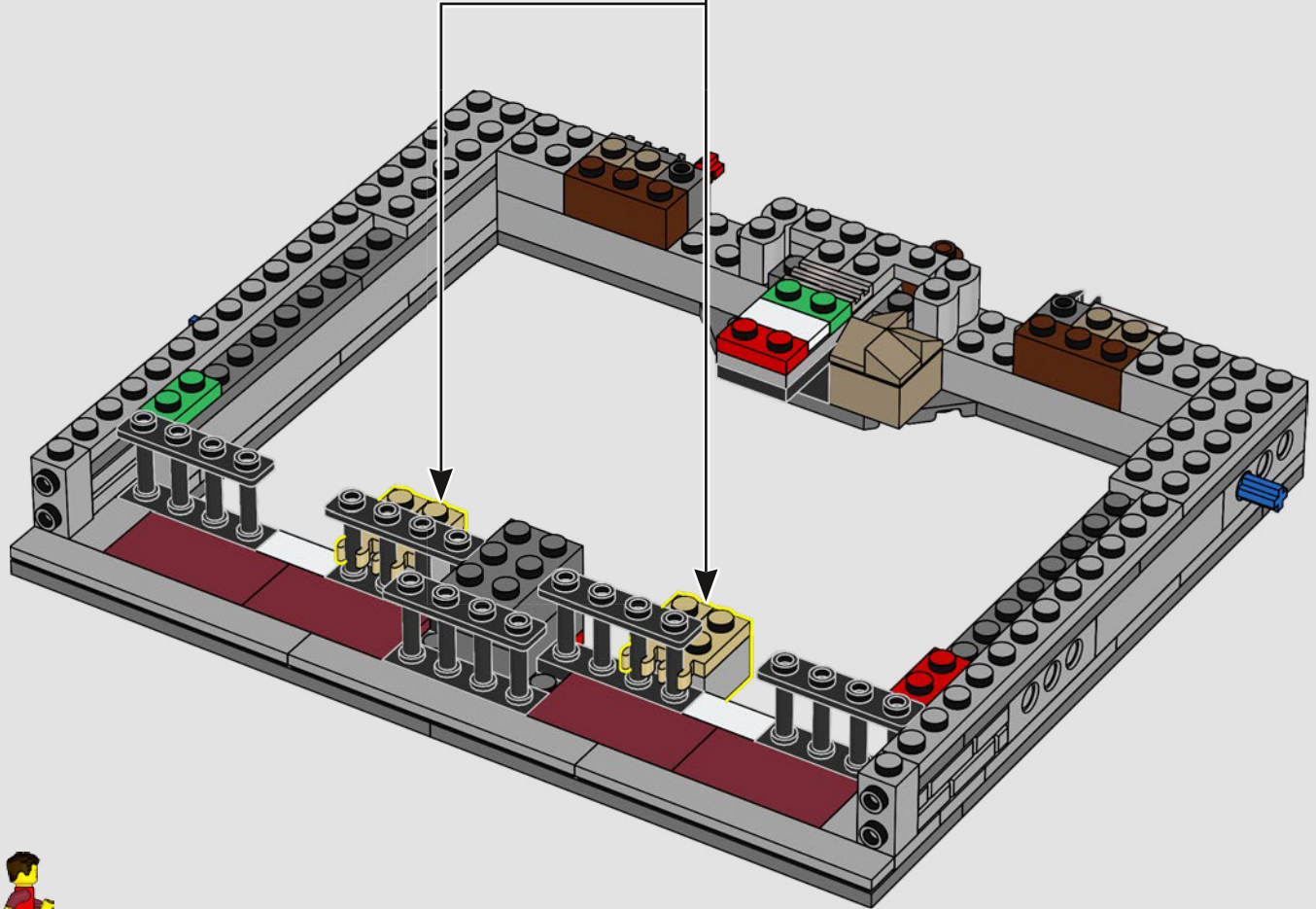
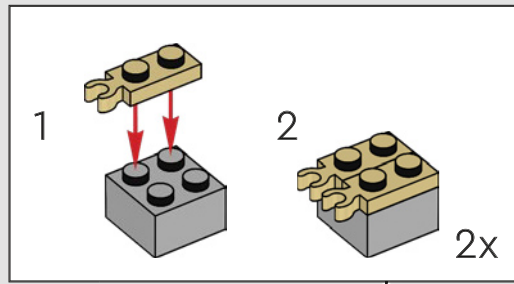



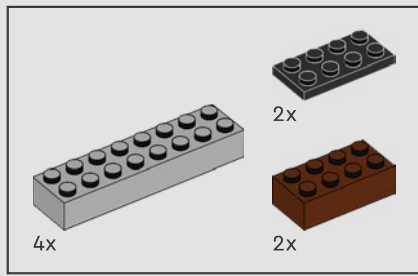

22

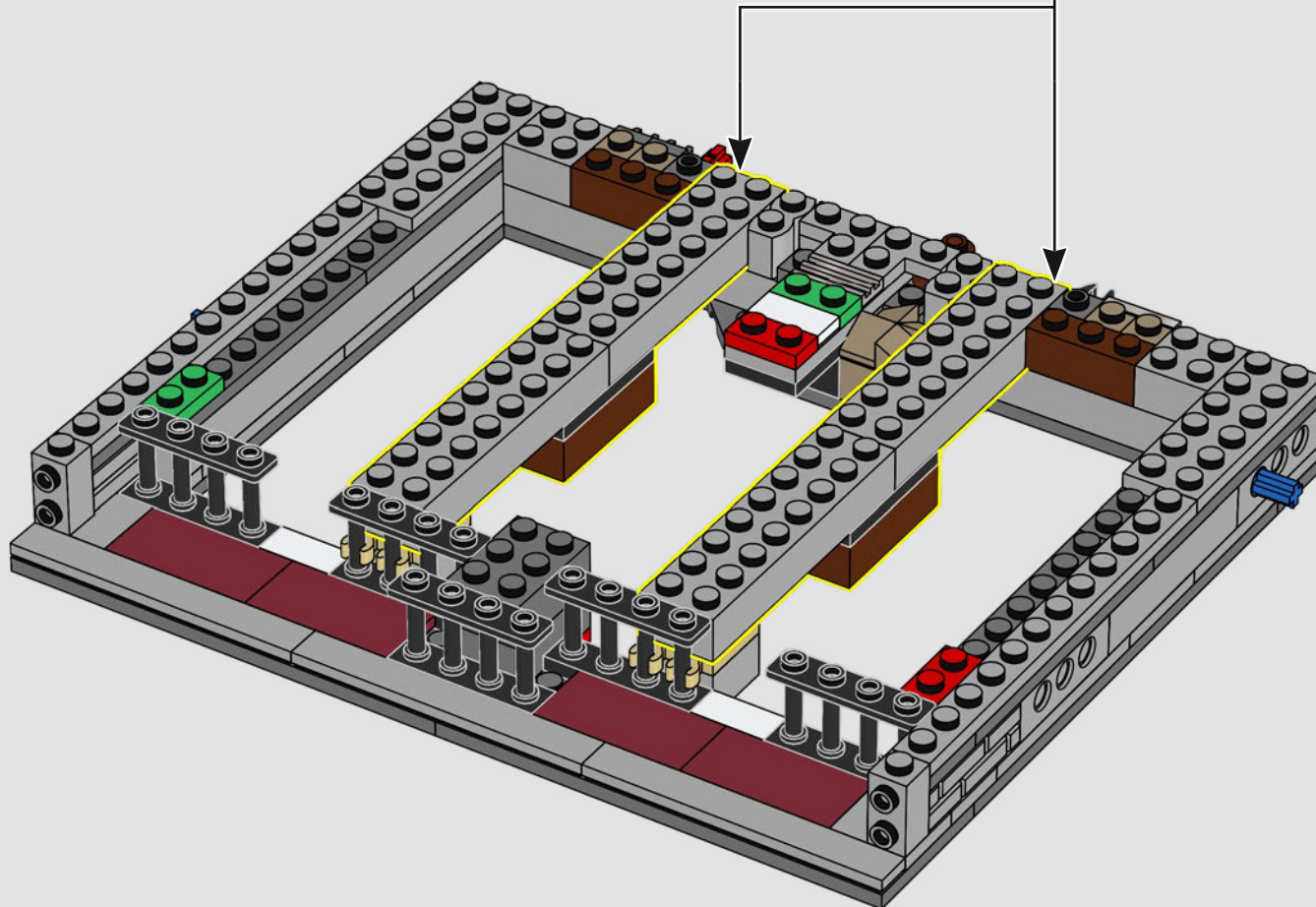
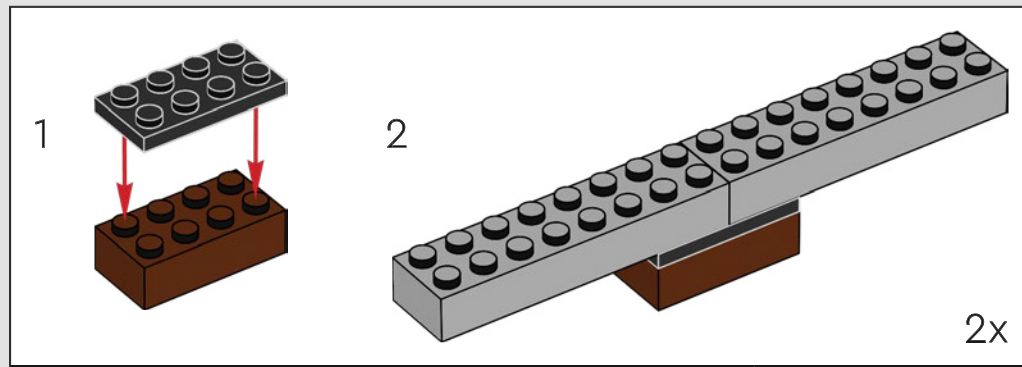

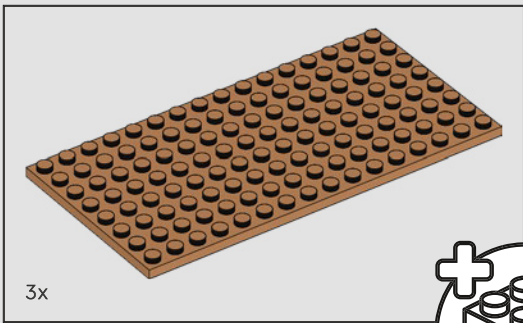

3x

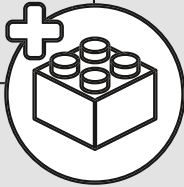

23

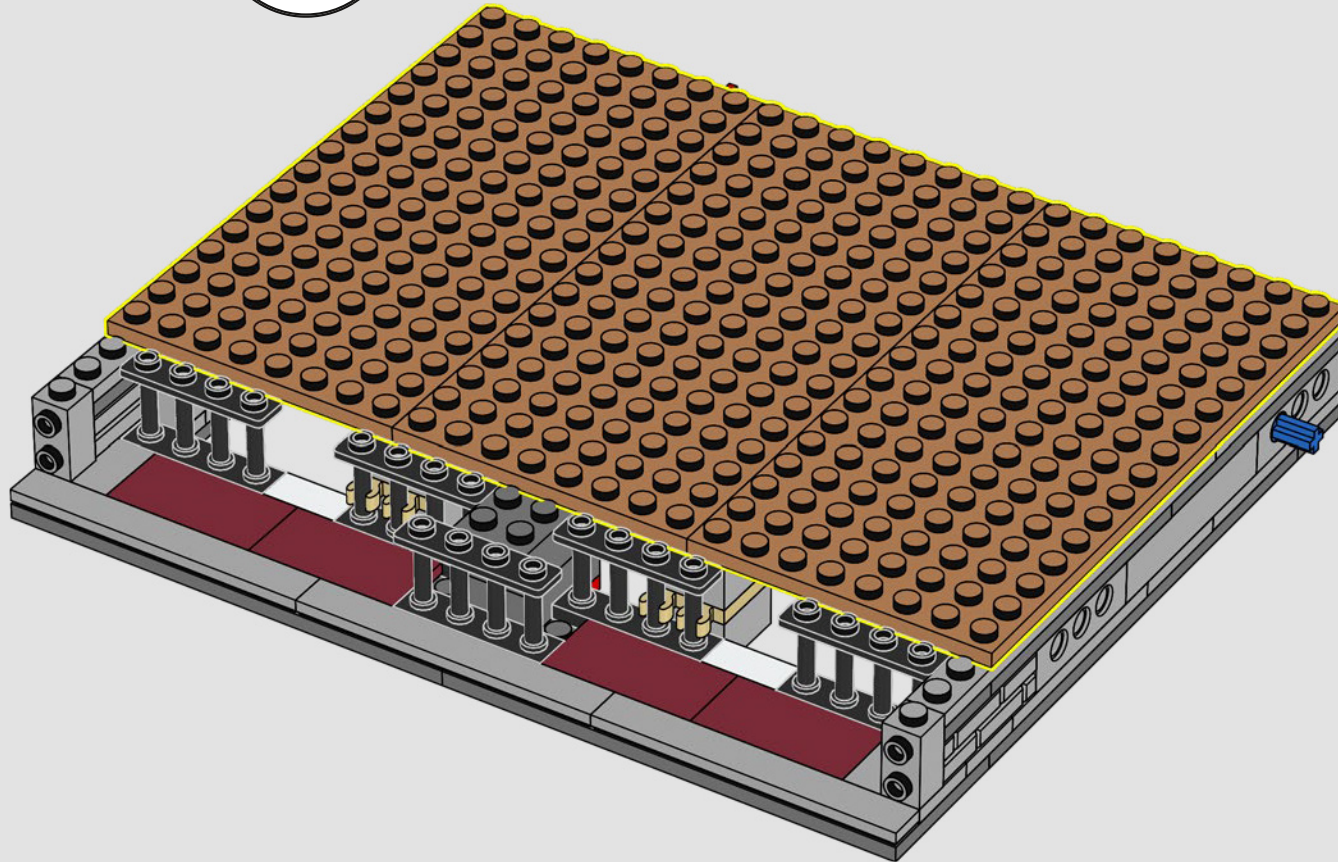



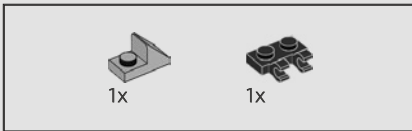
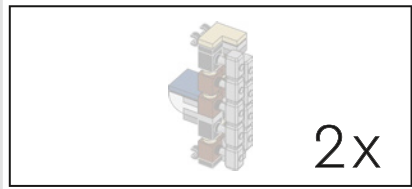

24

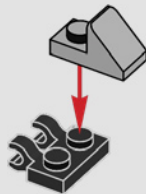

25

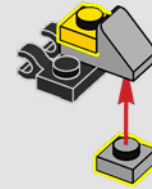

26

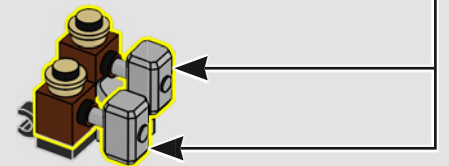
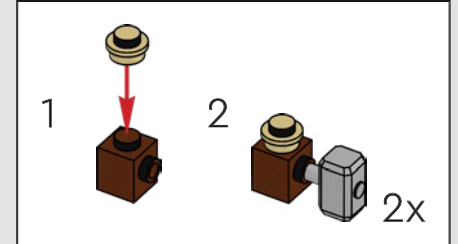

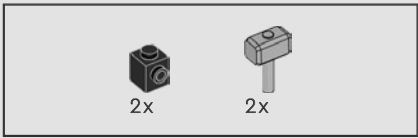

27

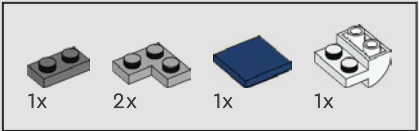
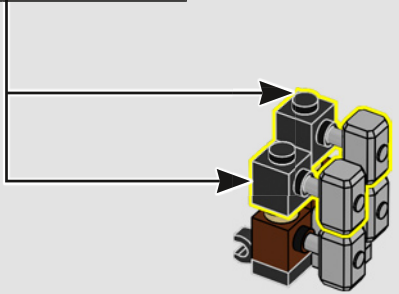
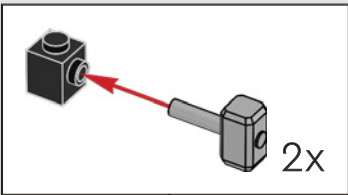

28

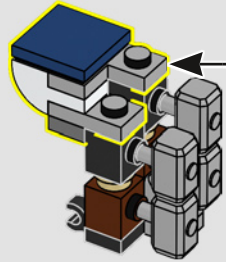
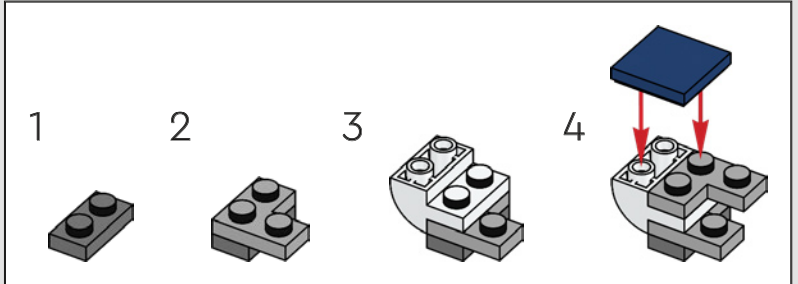



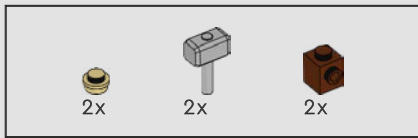

29

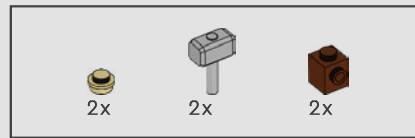
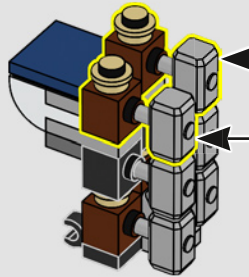
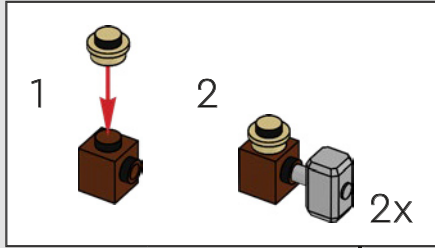

30

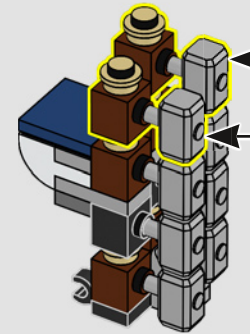
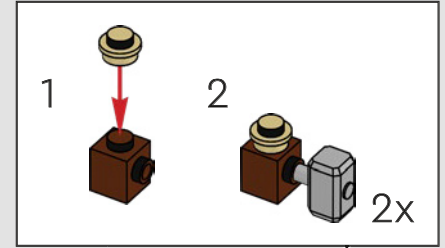

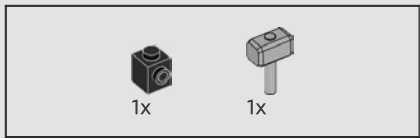

31

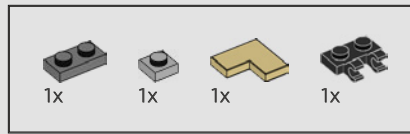
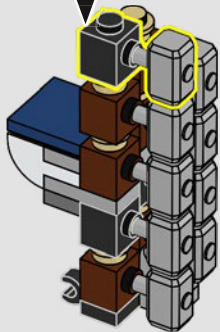
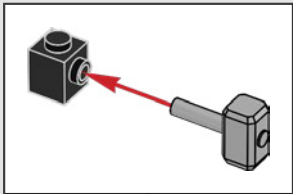

32

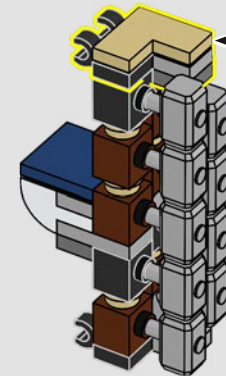
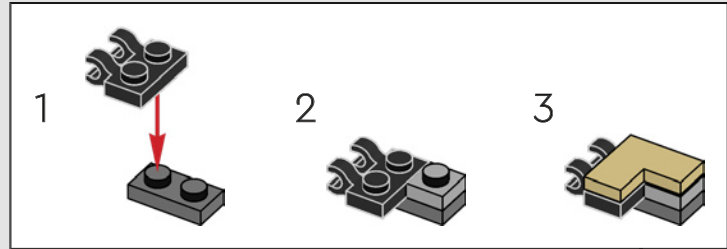

2x





33

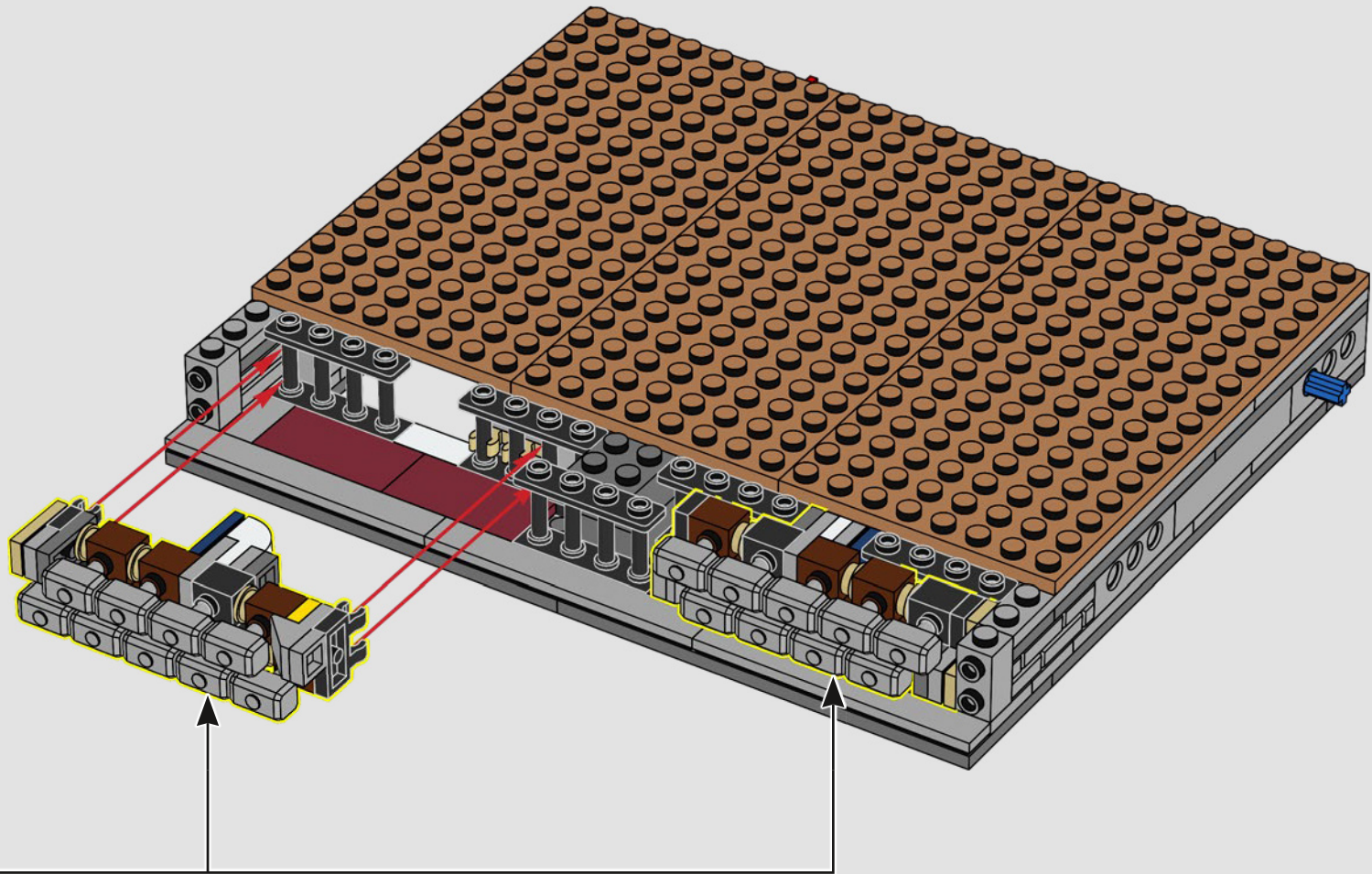



34

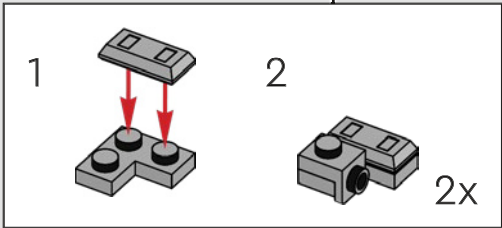
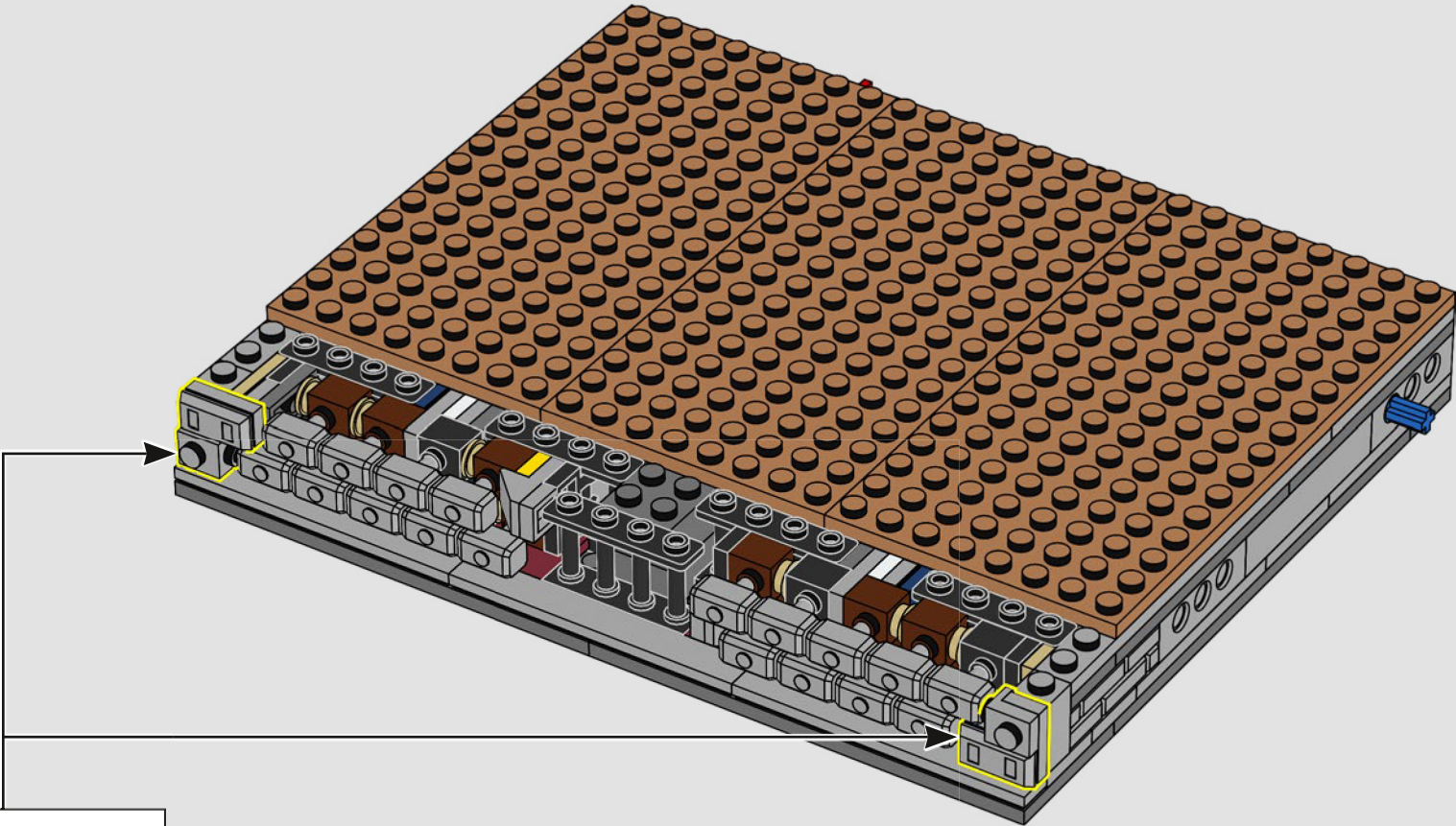



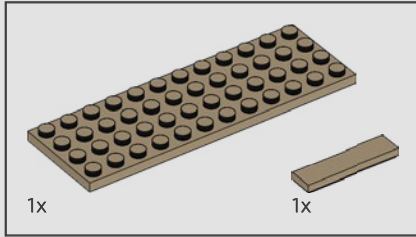
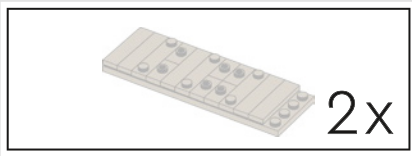

35

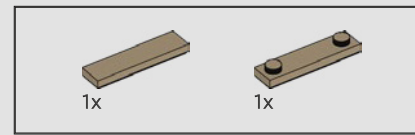
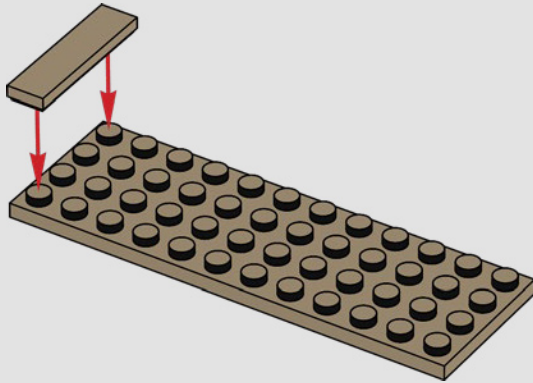

36

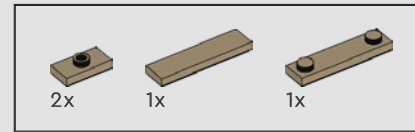
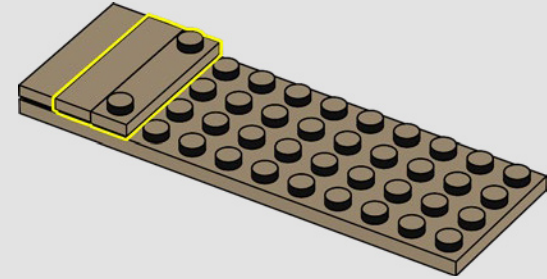

37

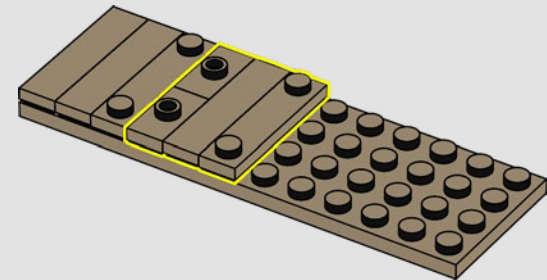



4x

38

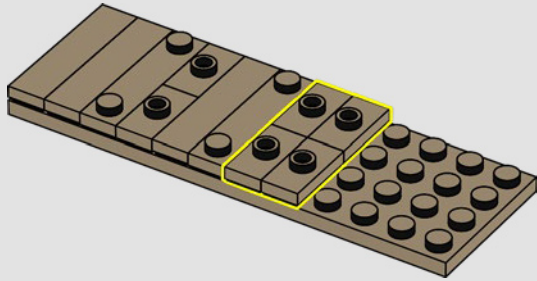

2x



1x

39

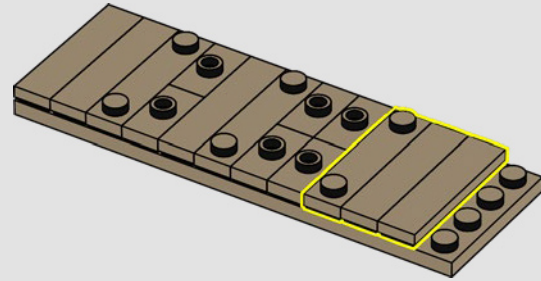

2x





40

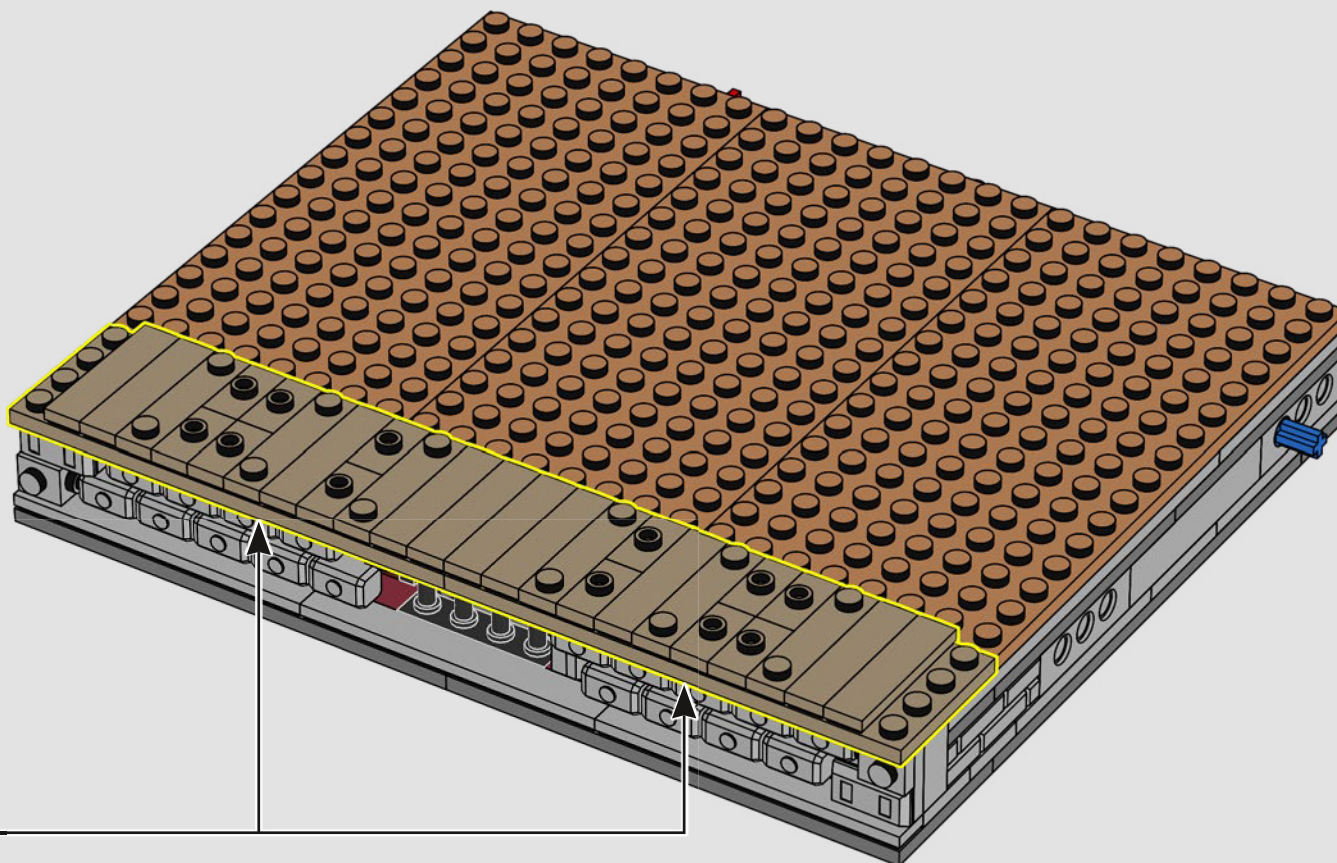

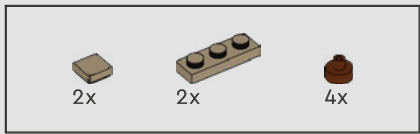

41

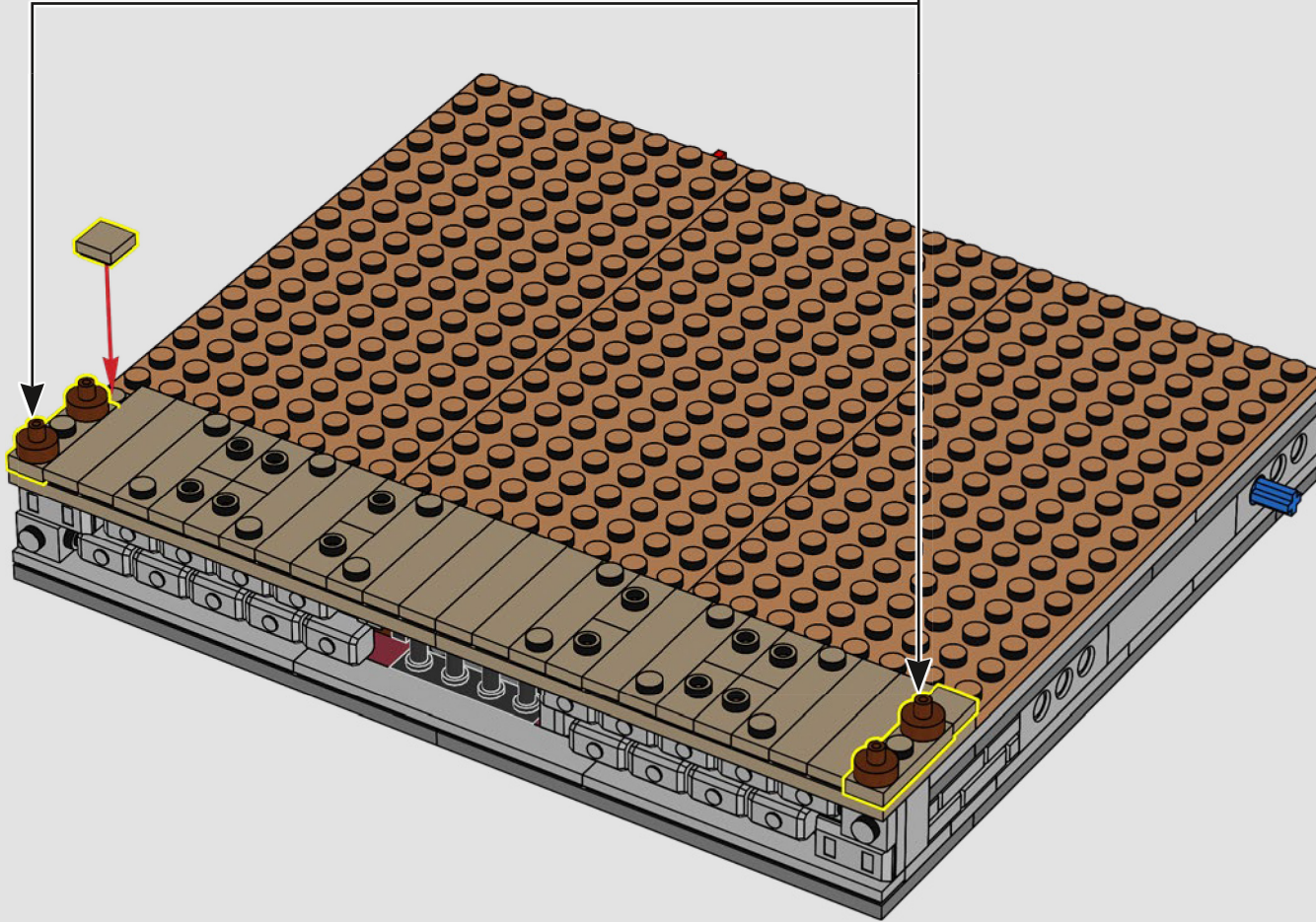
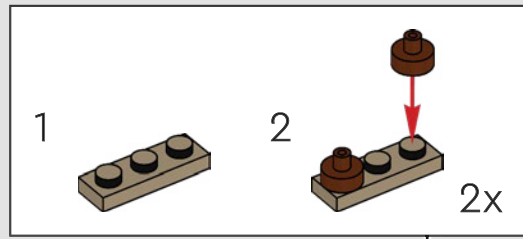







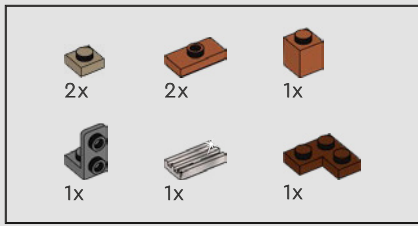

43

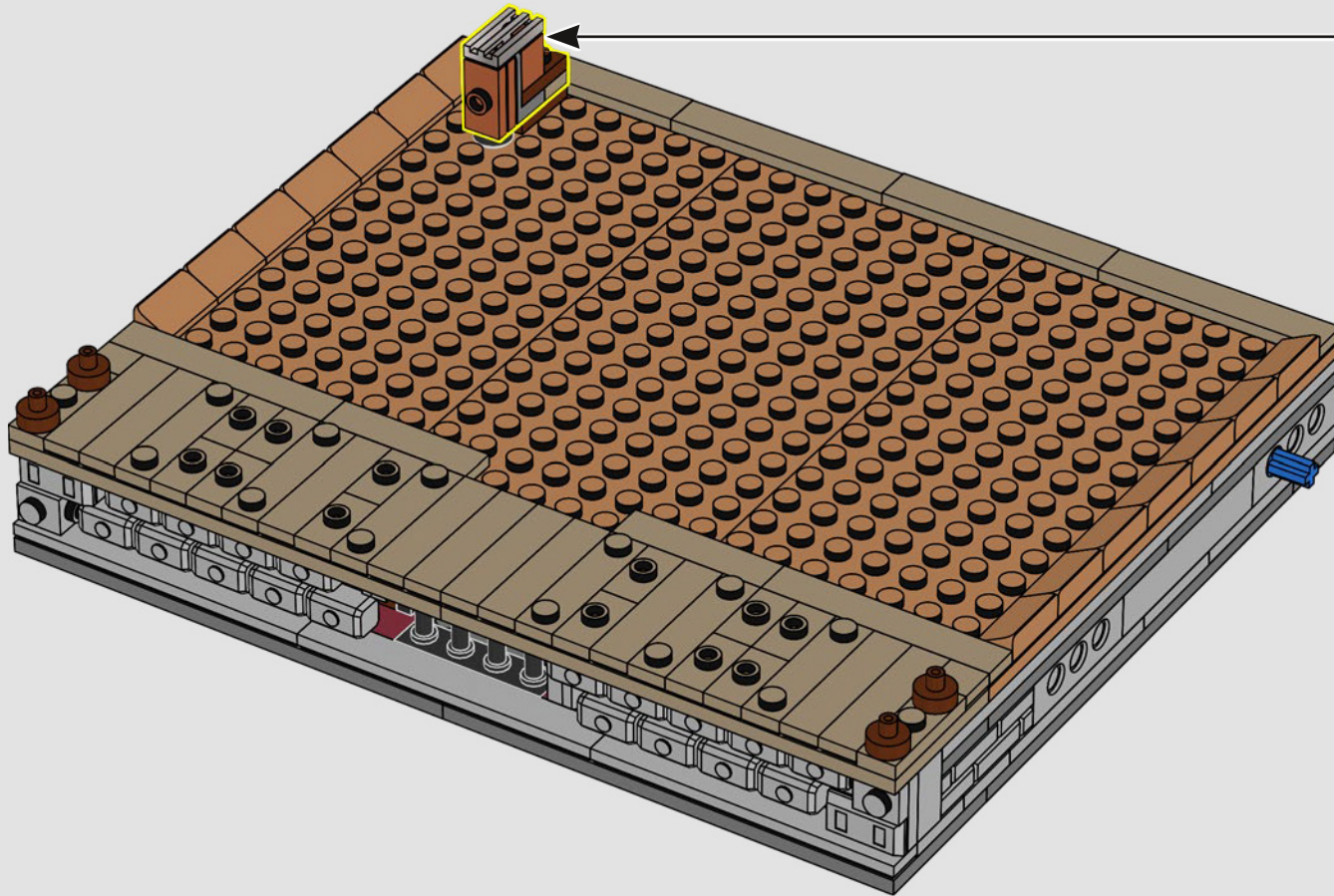
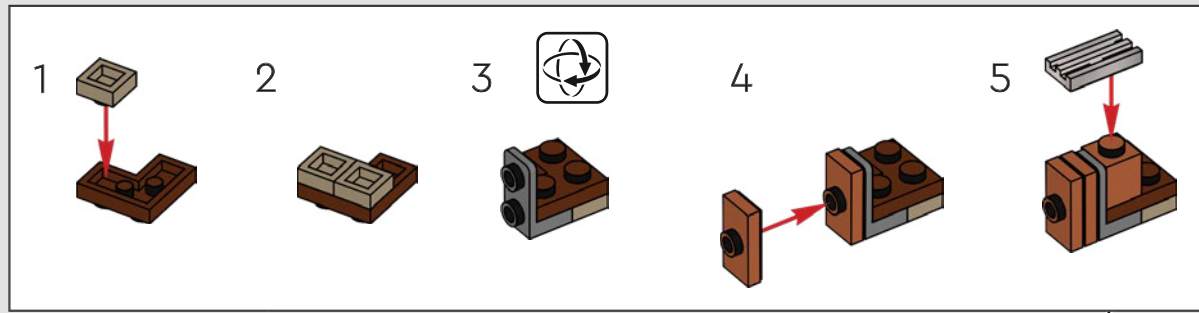

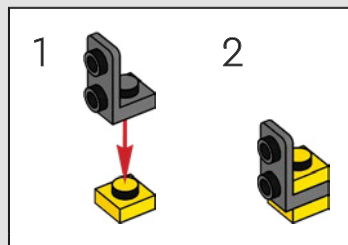
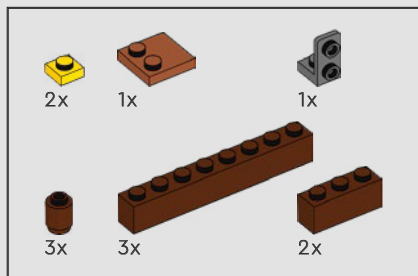

44

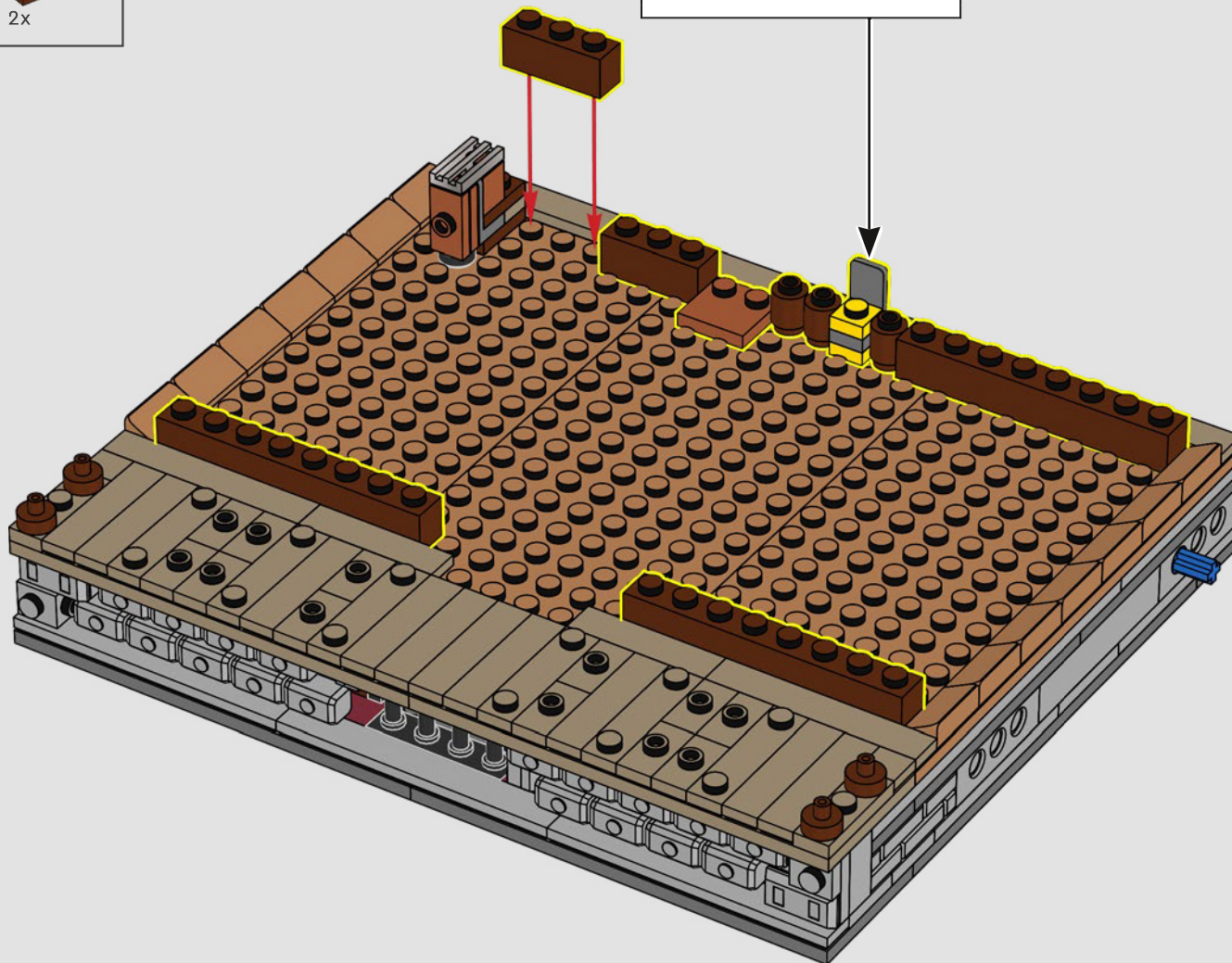



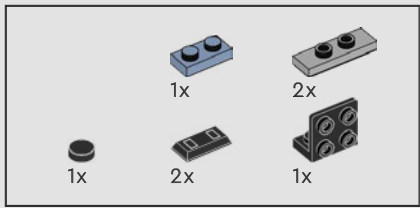

45

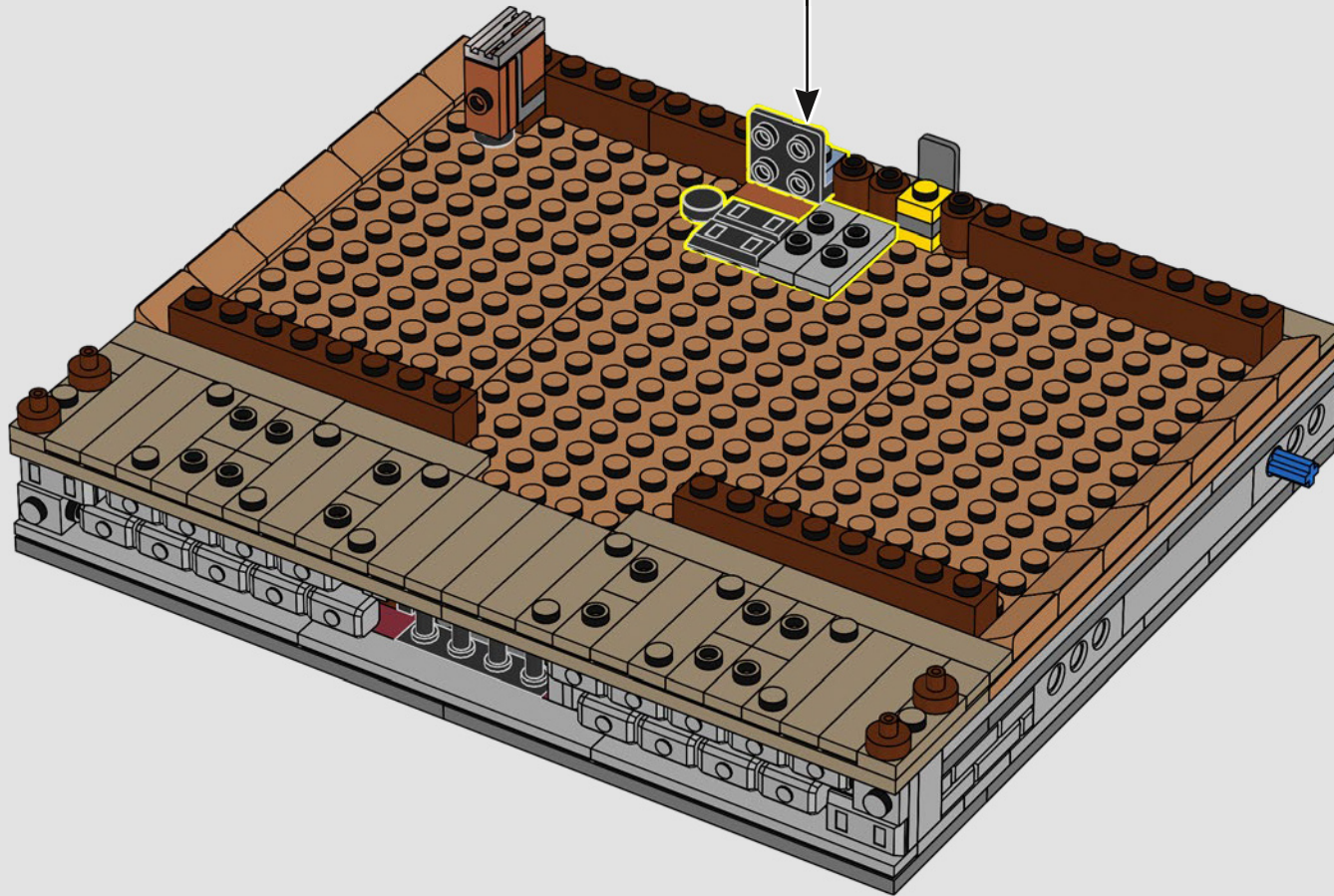
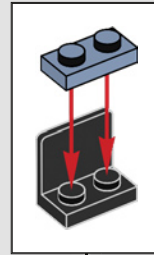

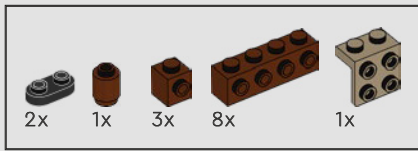

46

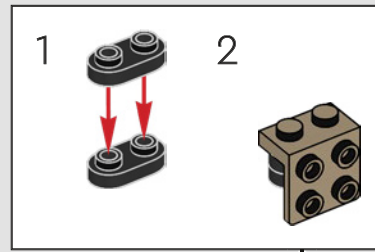

2

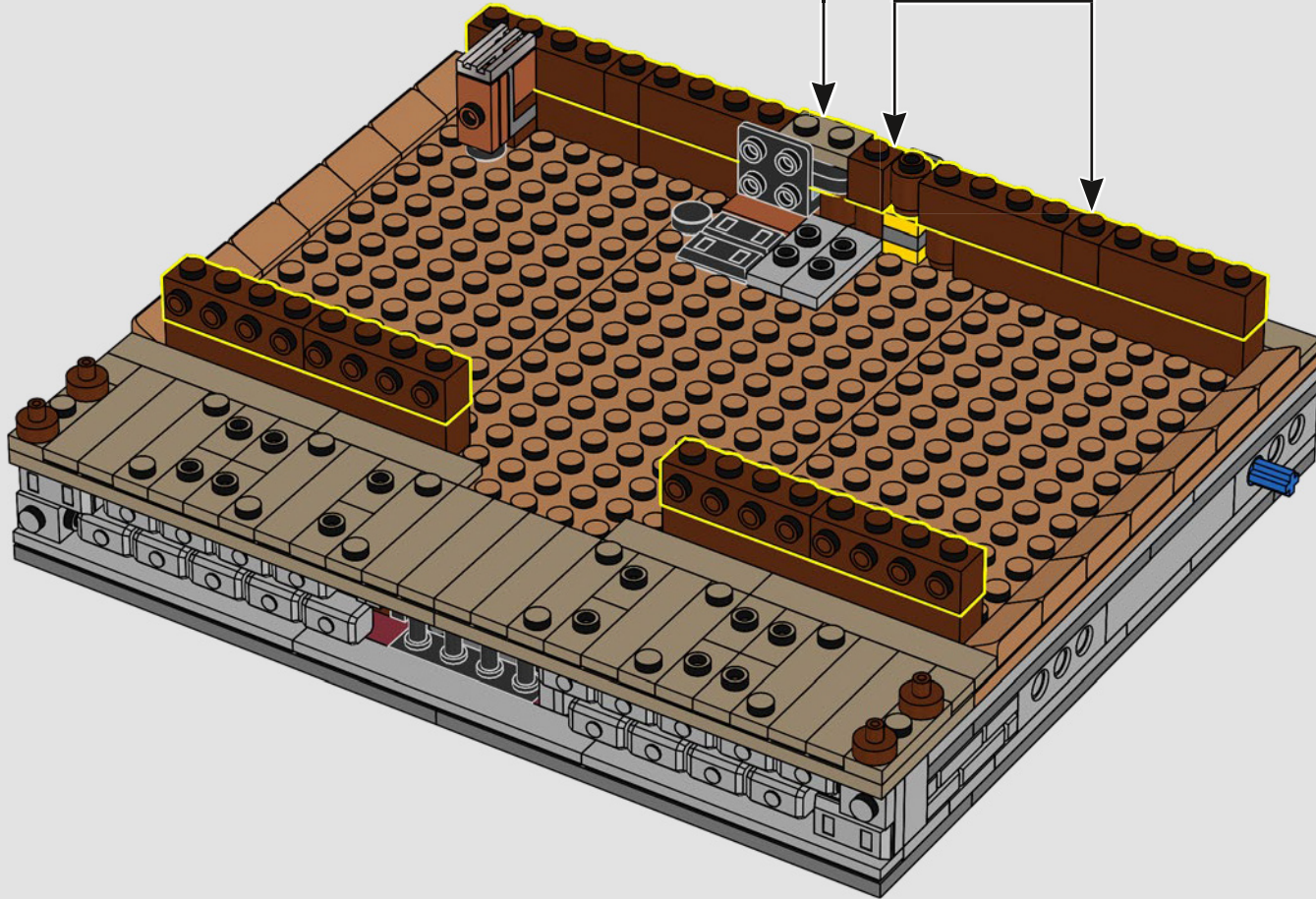
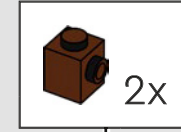



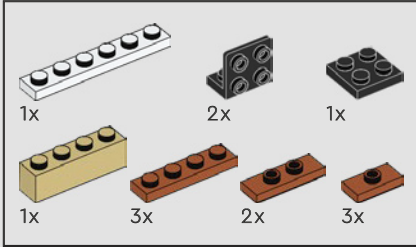
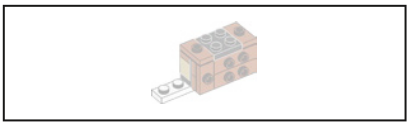

47

1

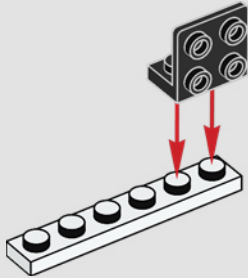

2

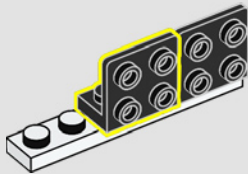

3

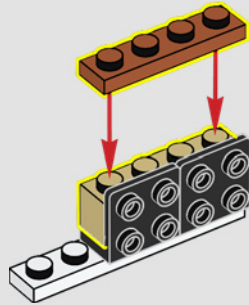

4

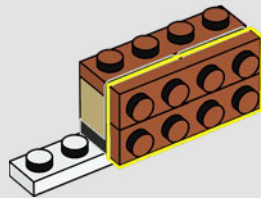

5

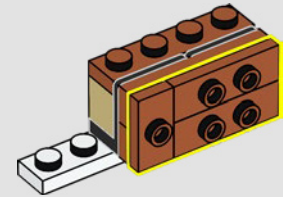

6

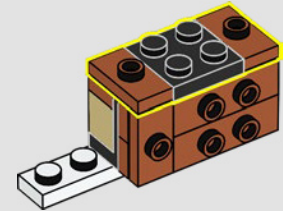

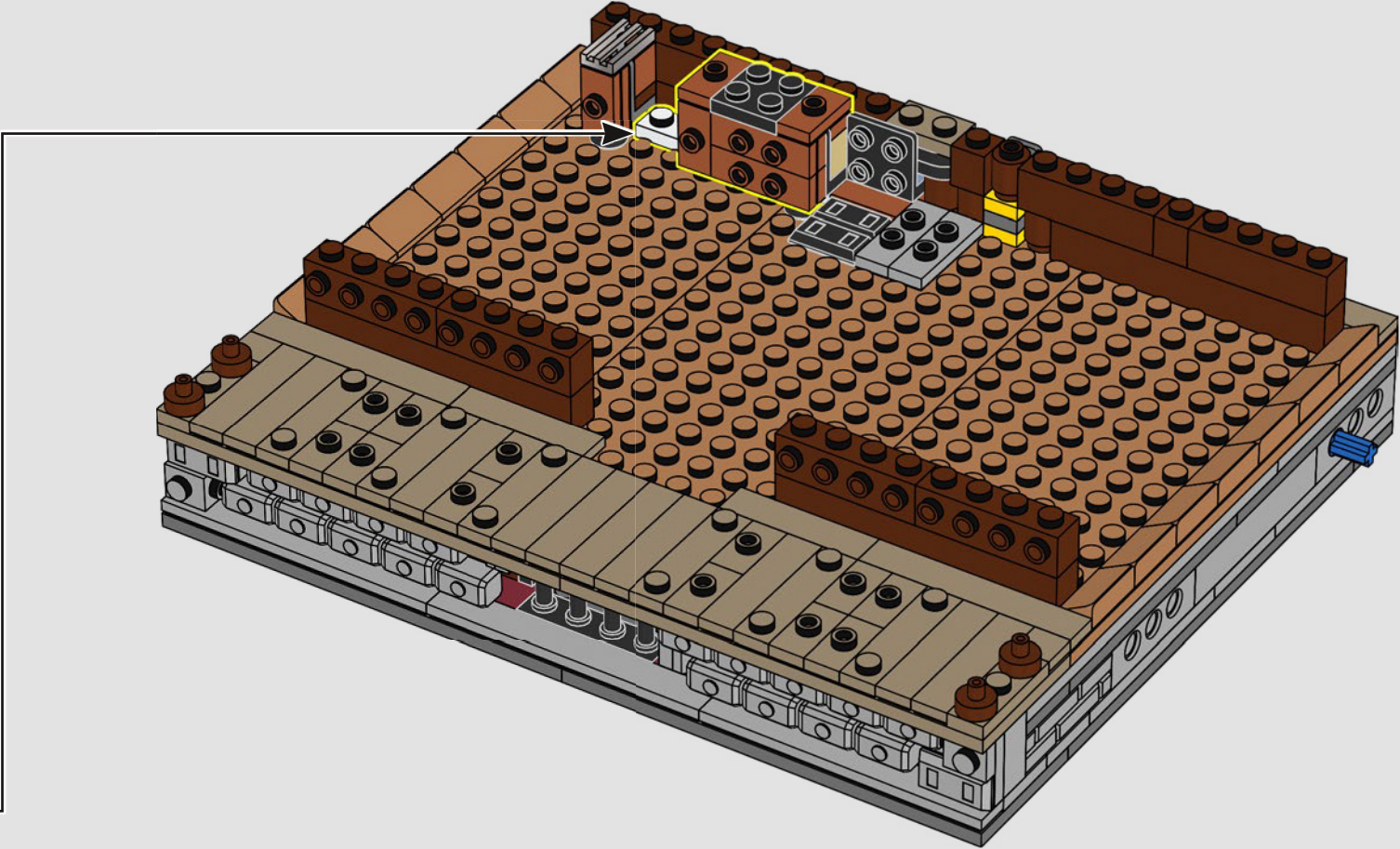



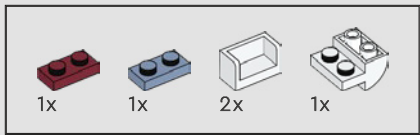

48

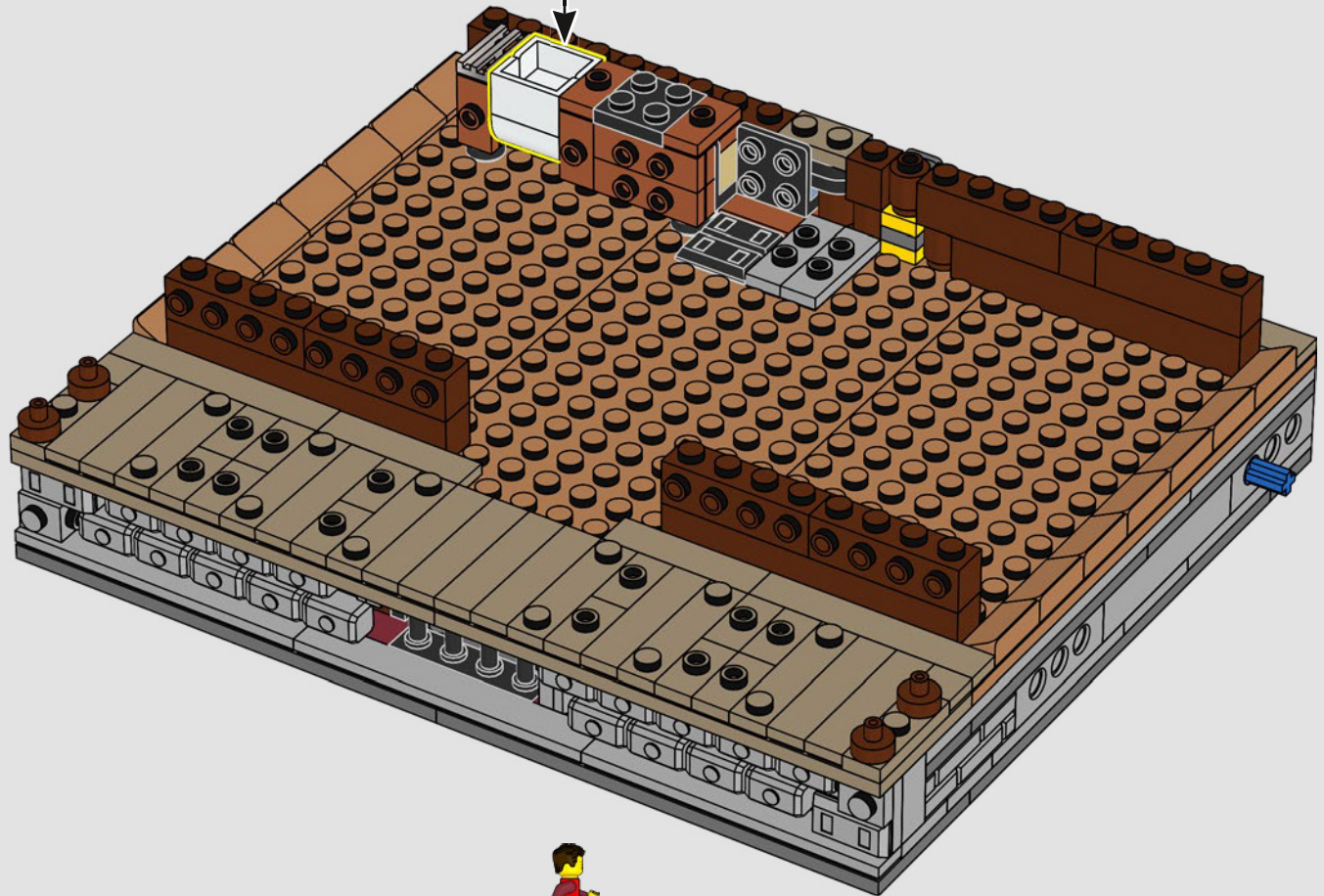
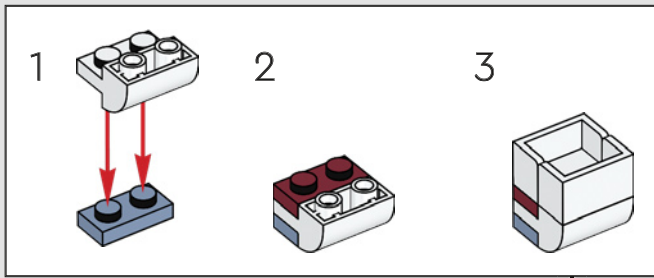

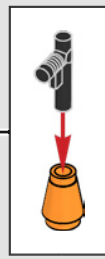
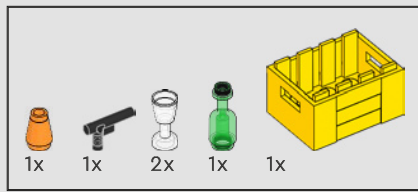

49

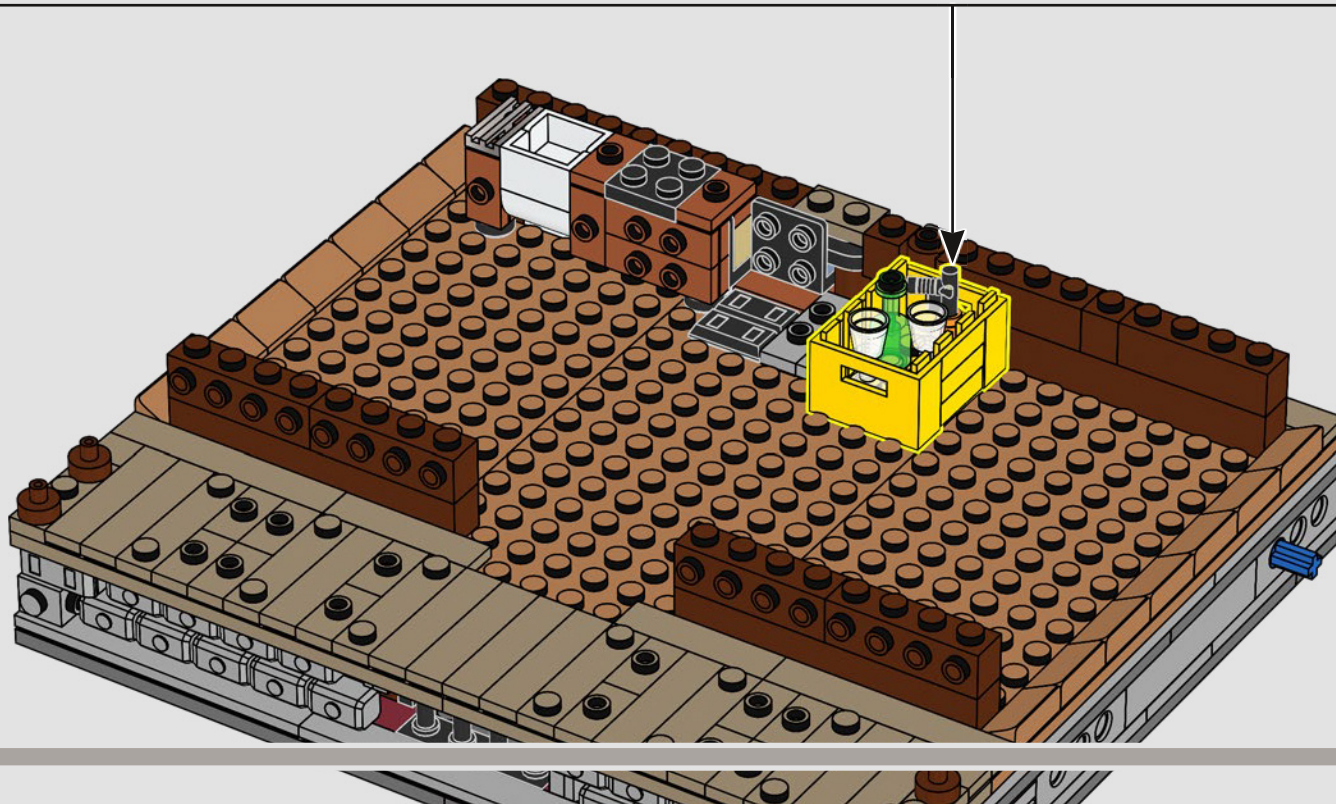
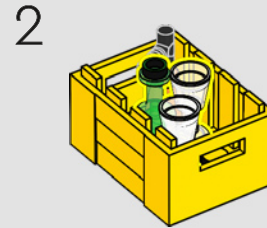
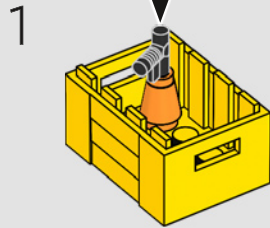



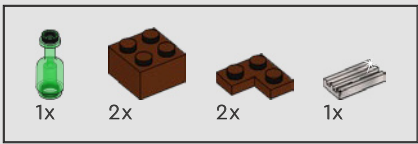

50

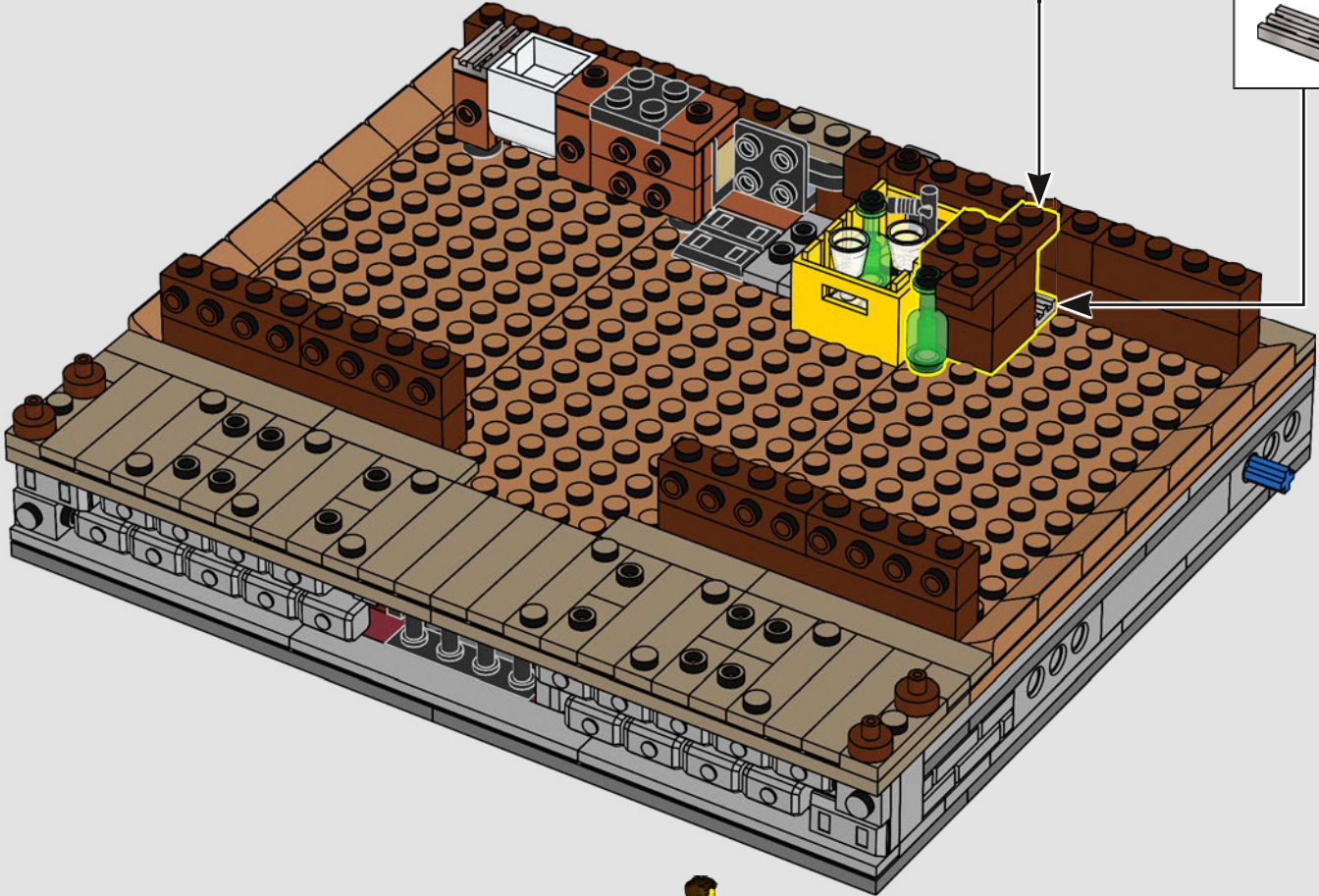
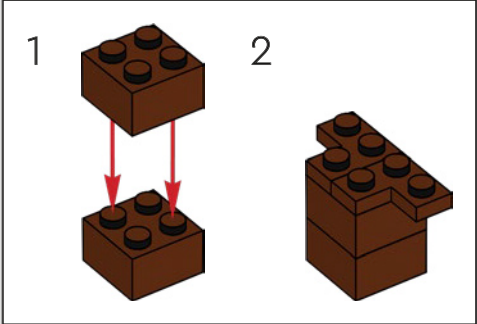



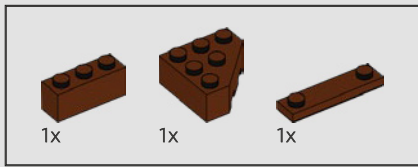

51

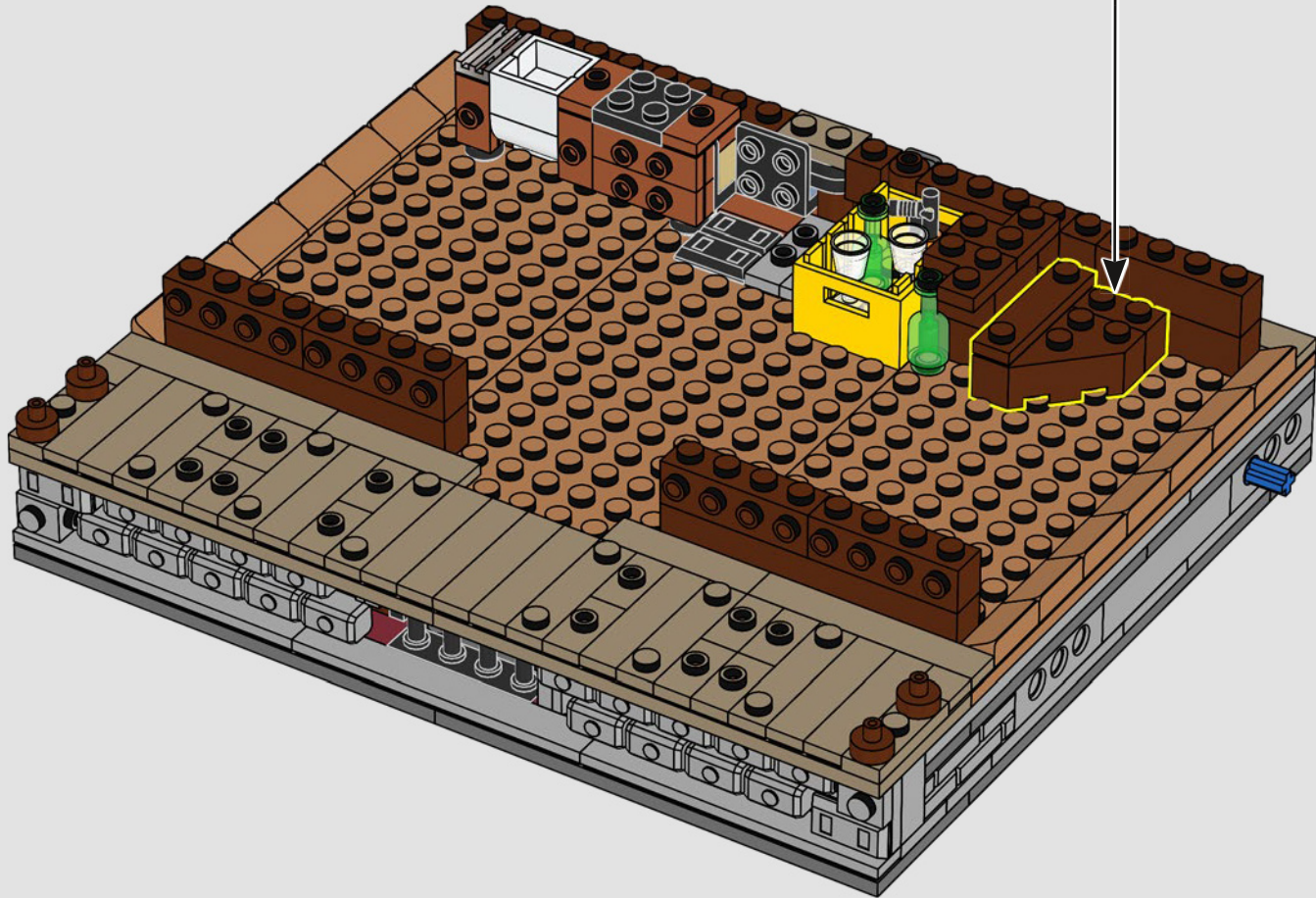
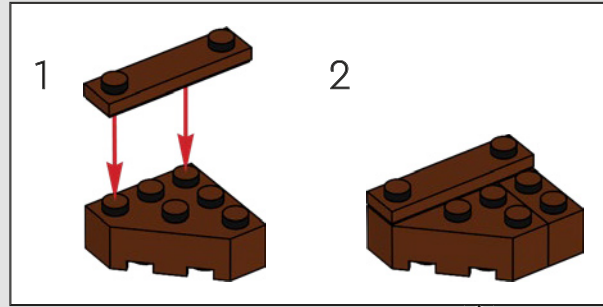

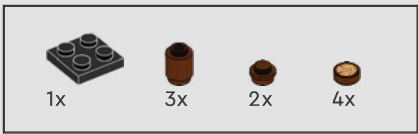

52

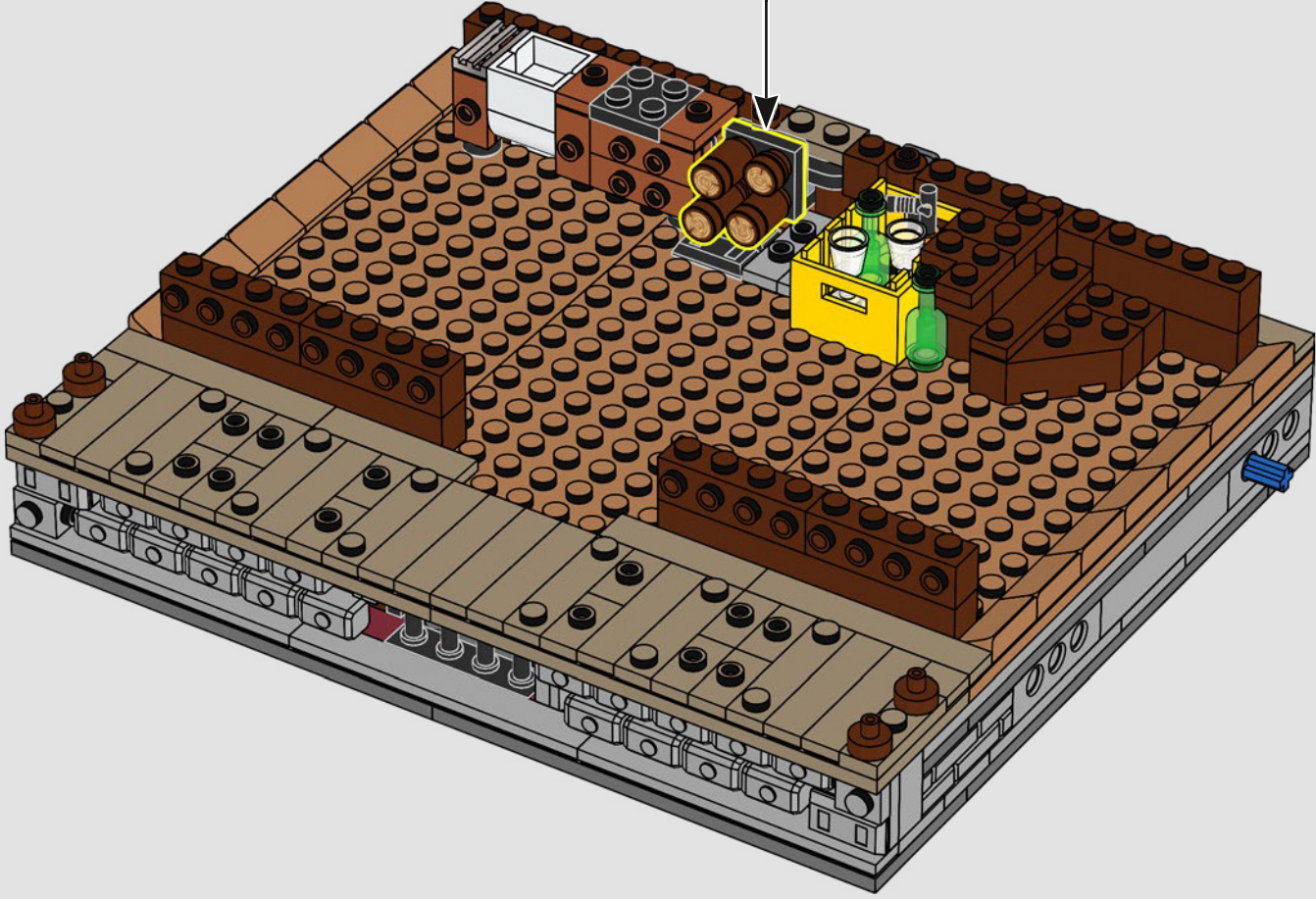
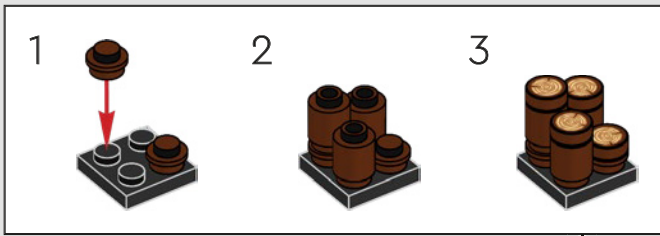





53

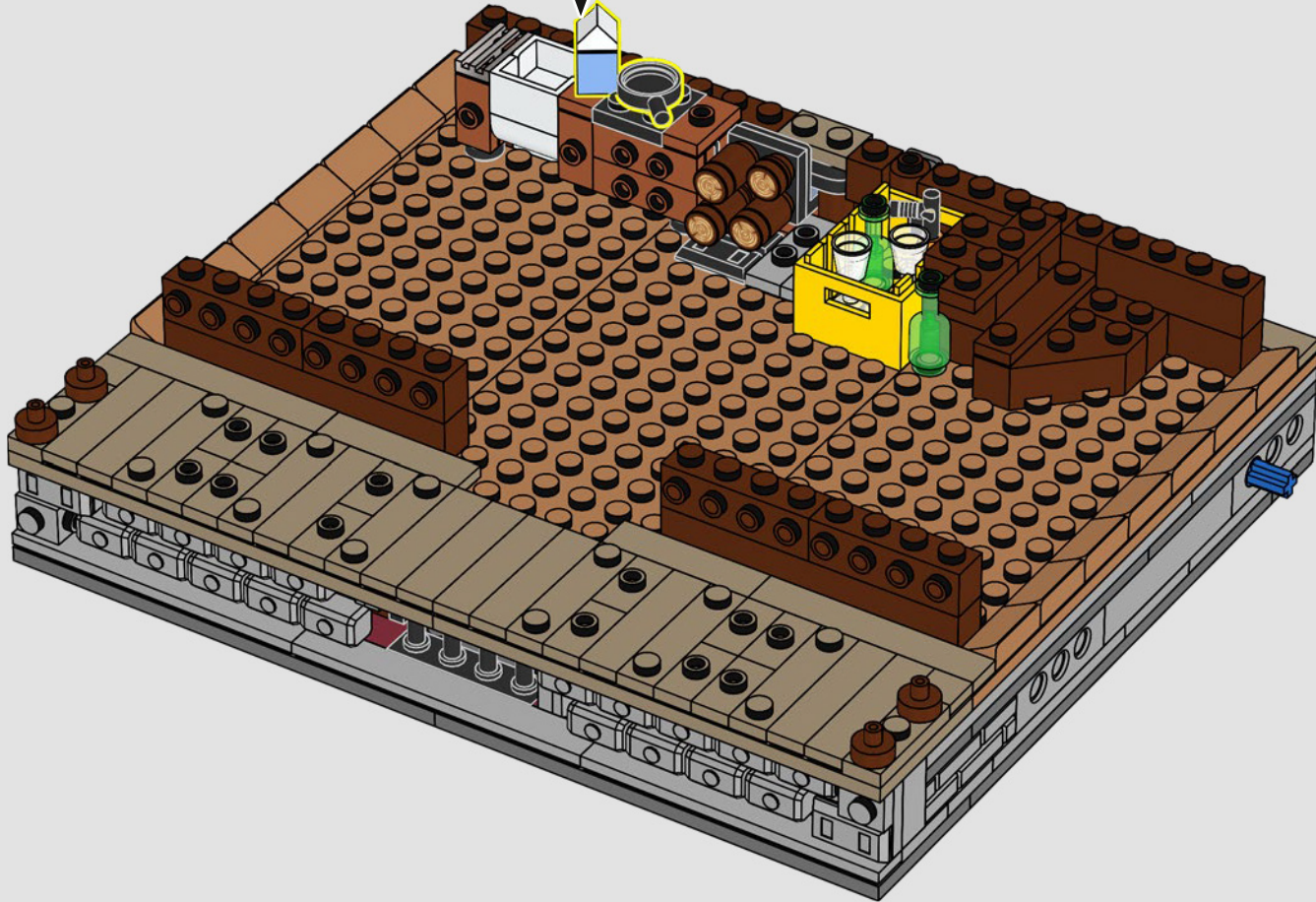
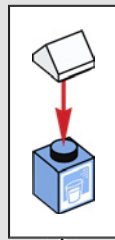

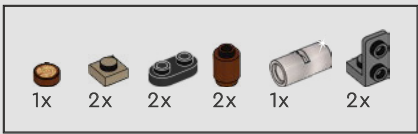

54

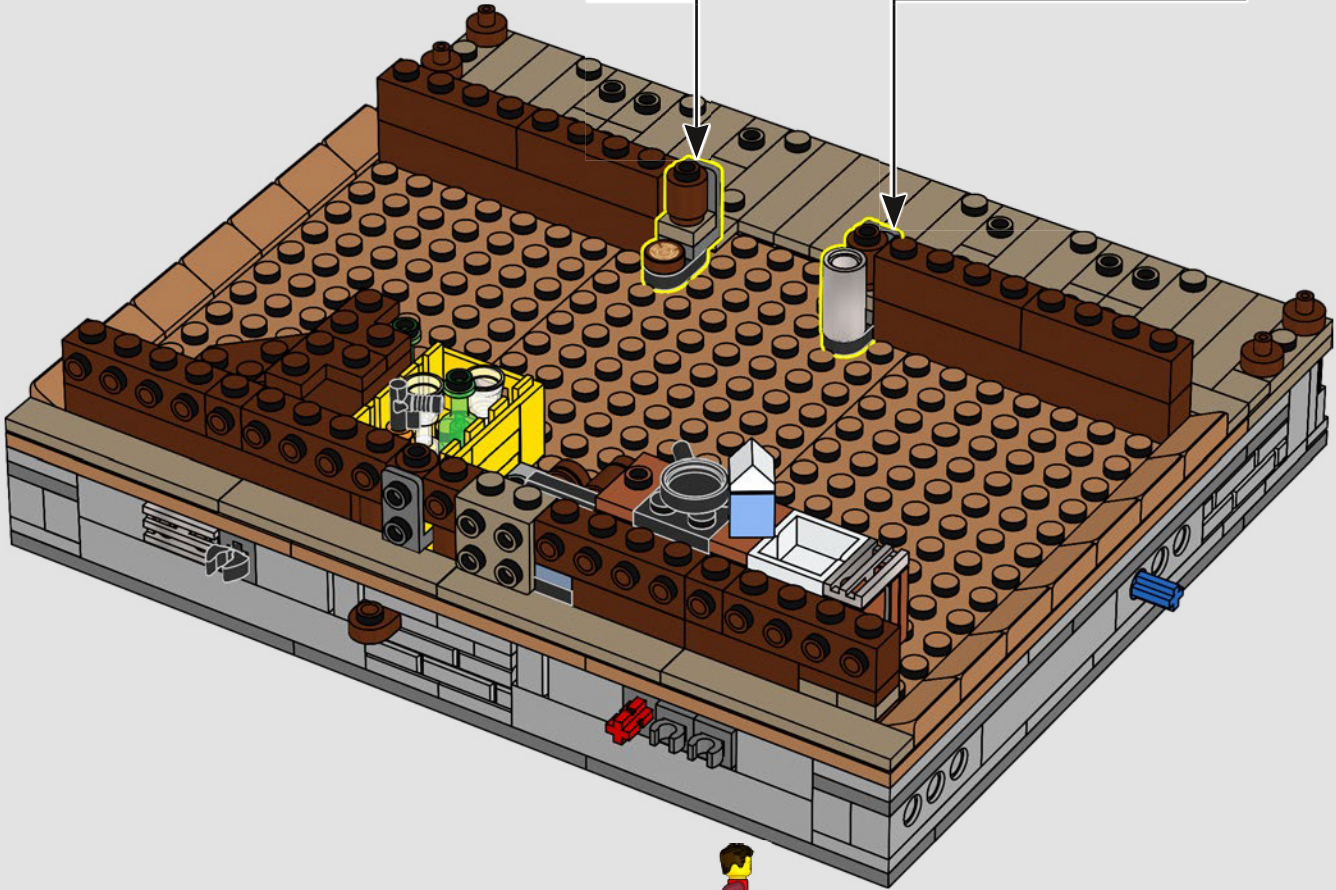
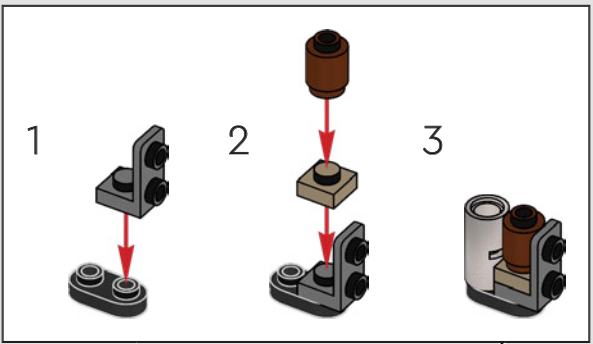
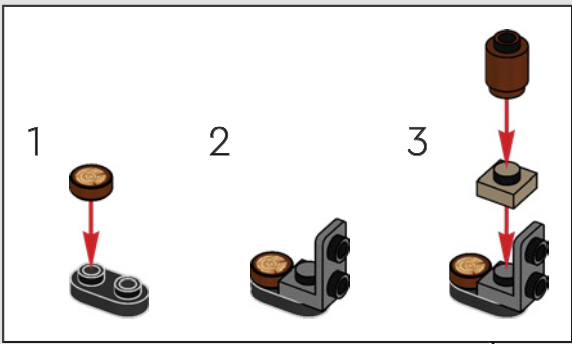



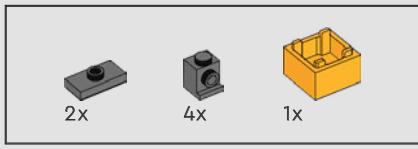

55

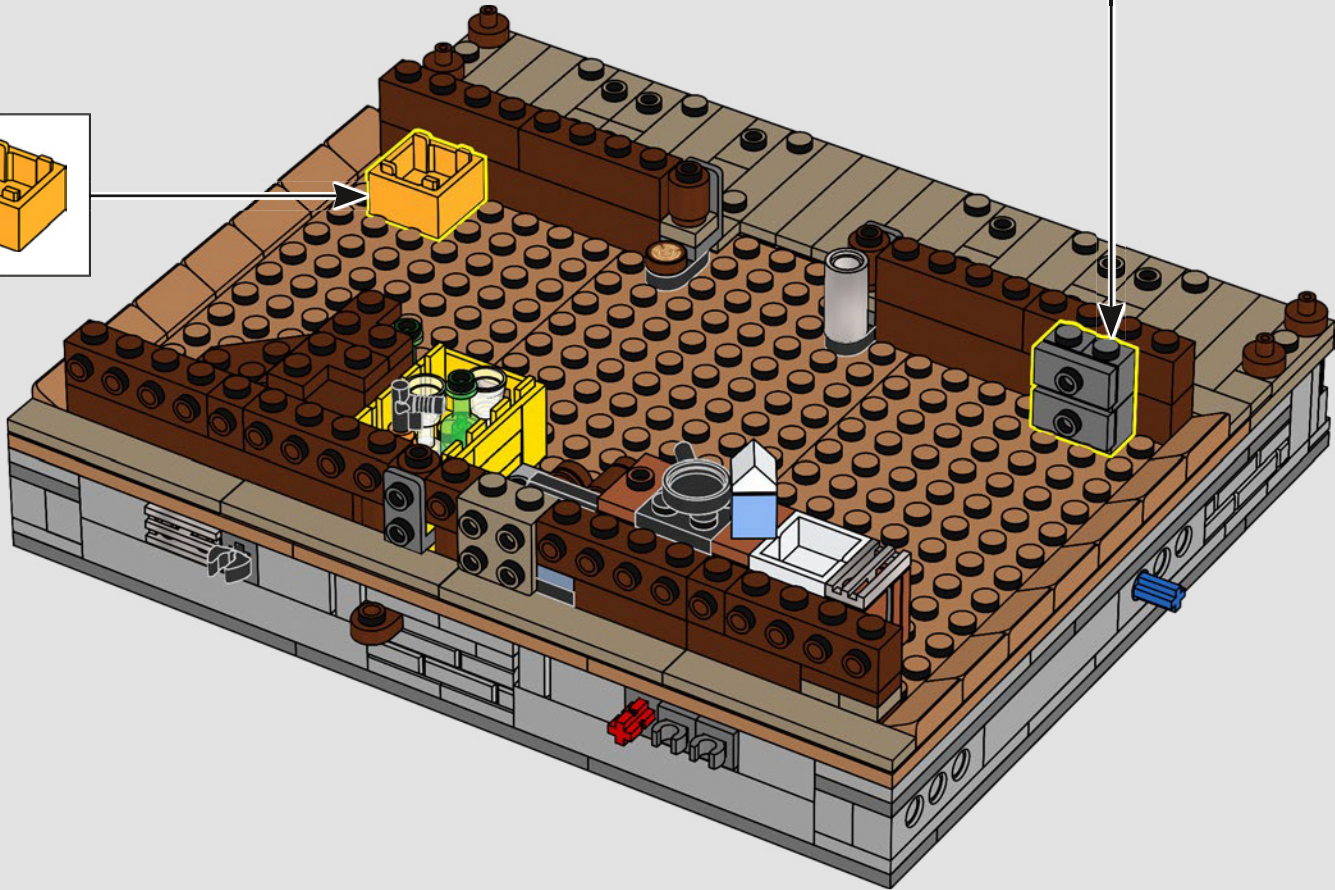
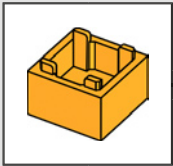
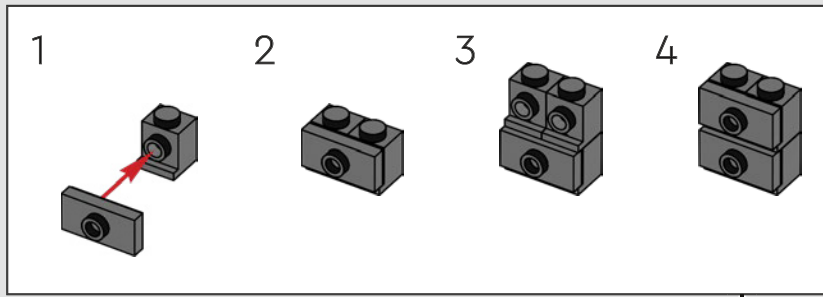

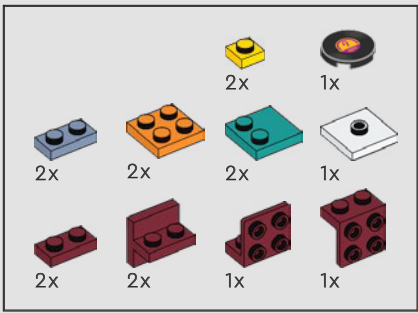

56

1

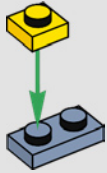

2

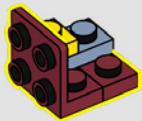

3

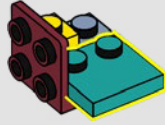

4

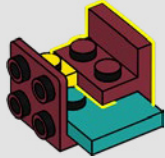

5

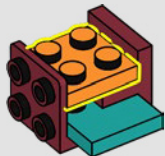

6



7

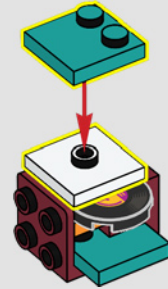

8

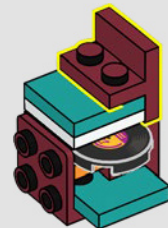



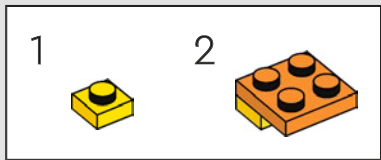

9



10

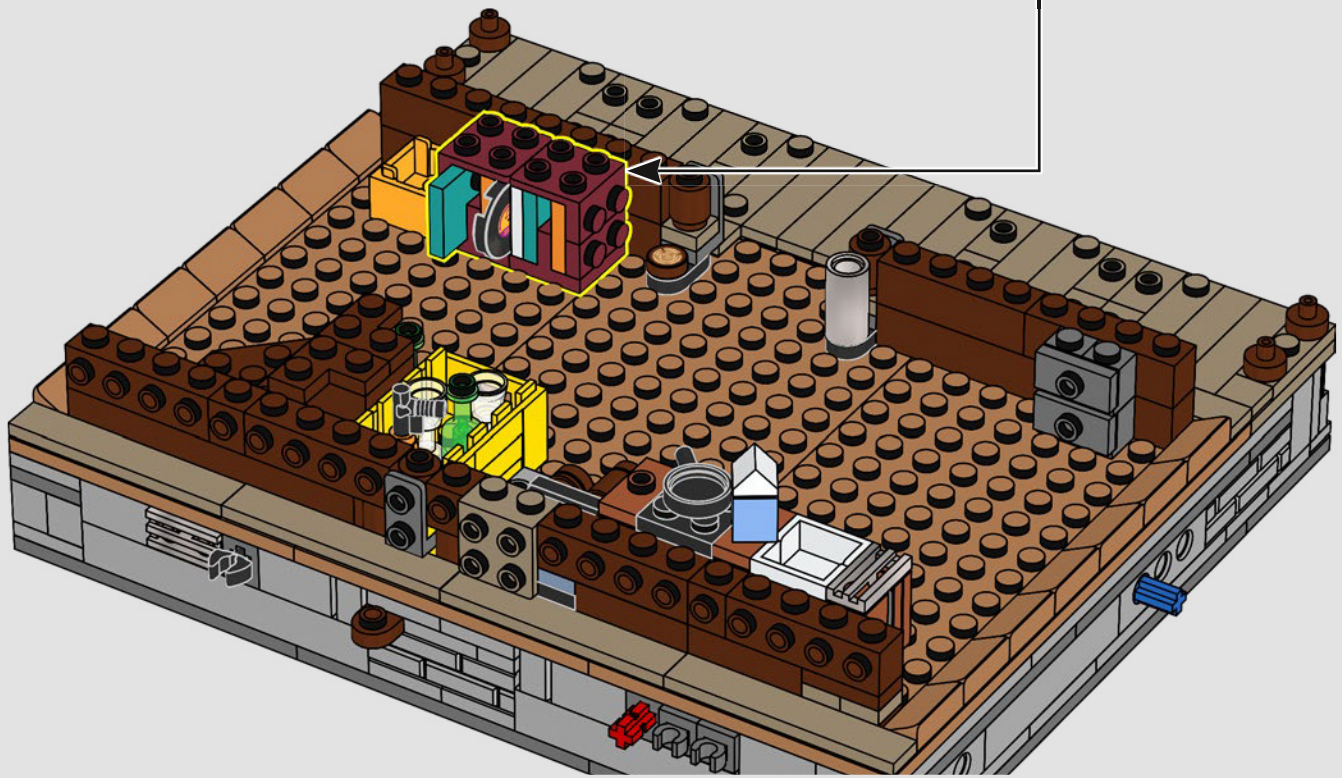

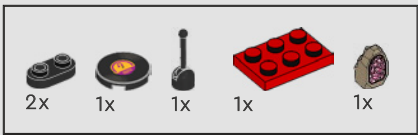

57

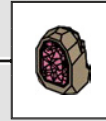
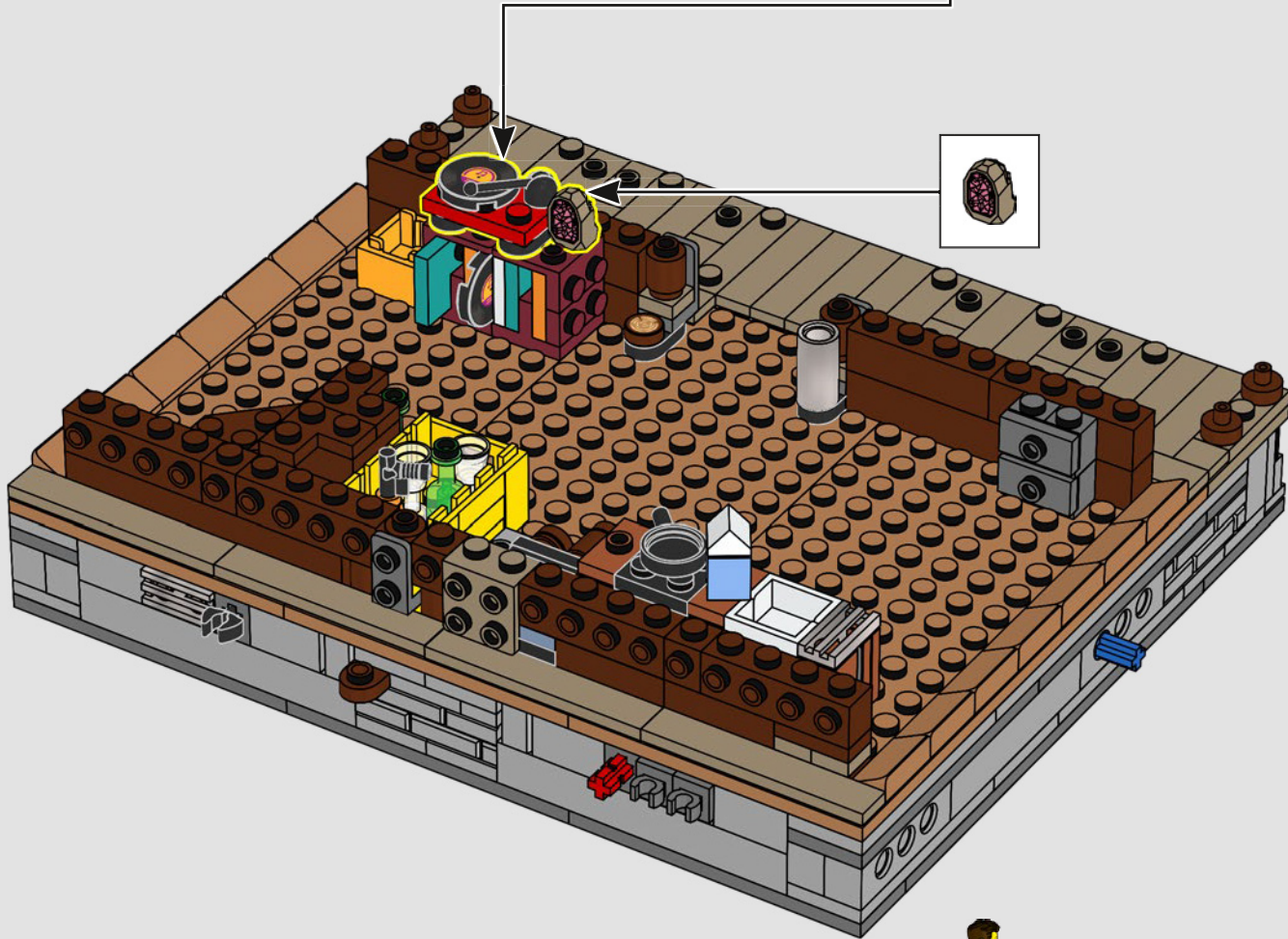
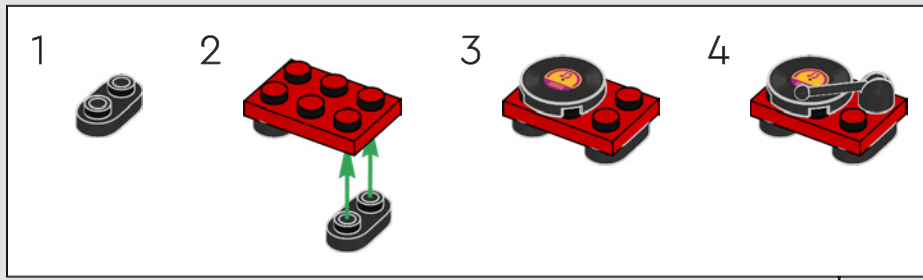



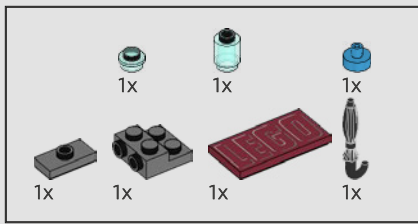

58

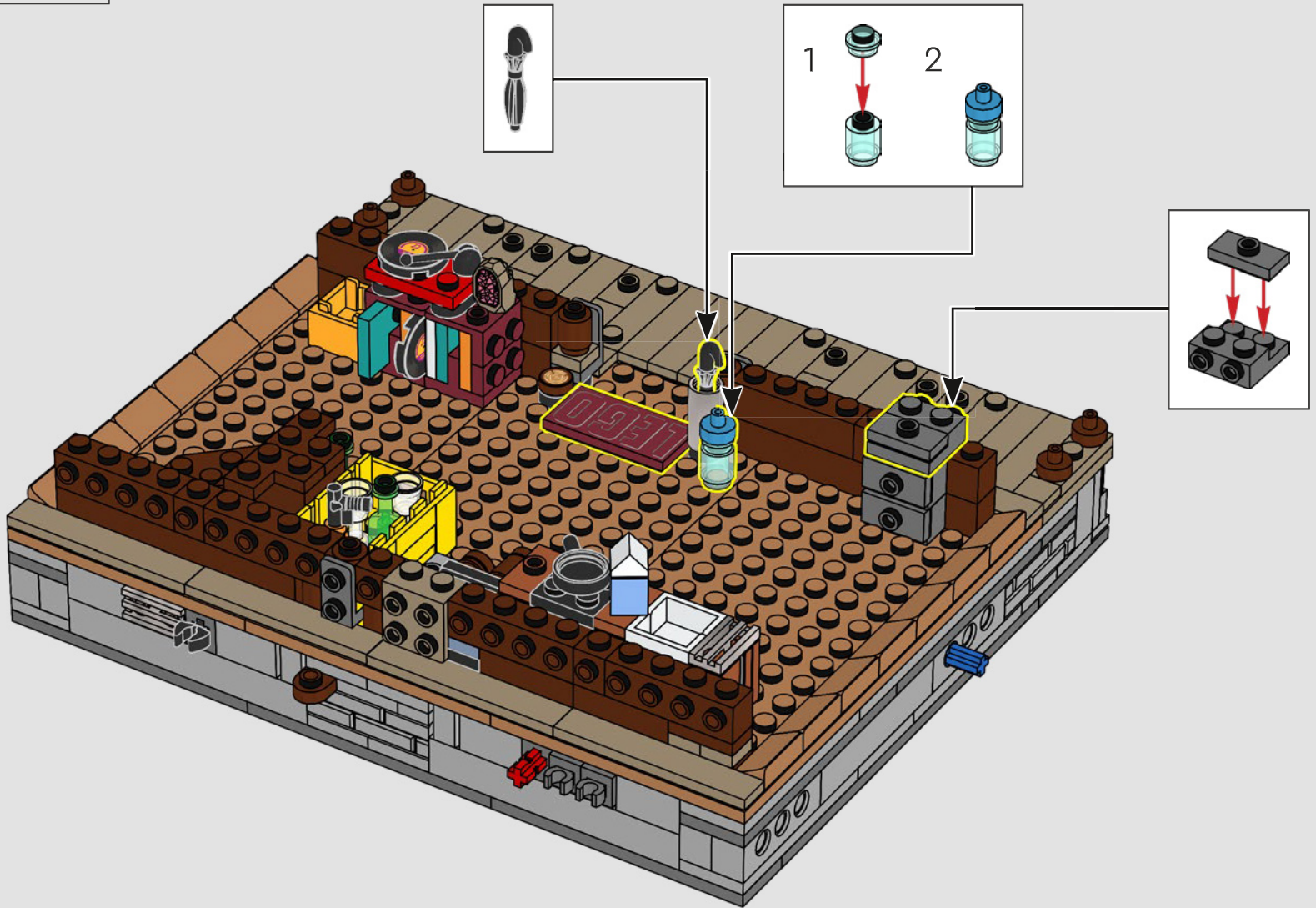

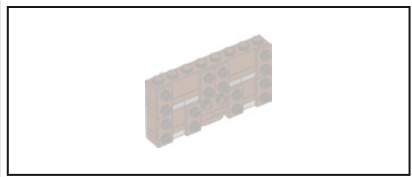

59

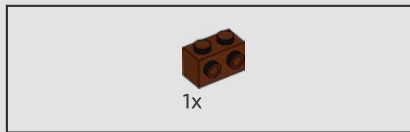
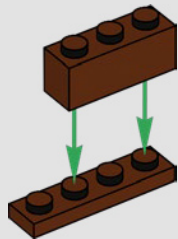

60

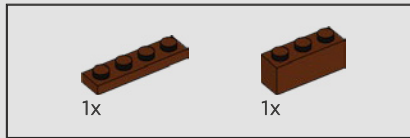
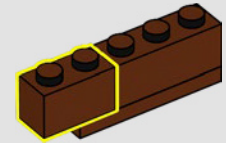

61

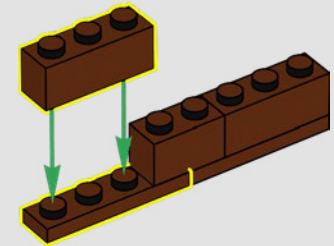

62

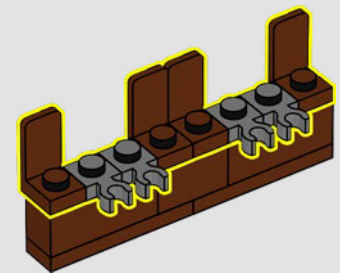





63

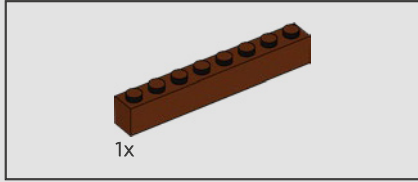
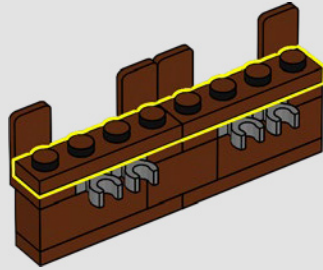

64

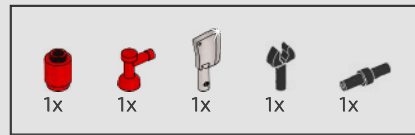
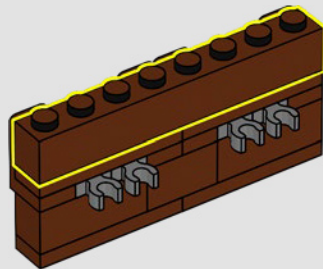

65

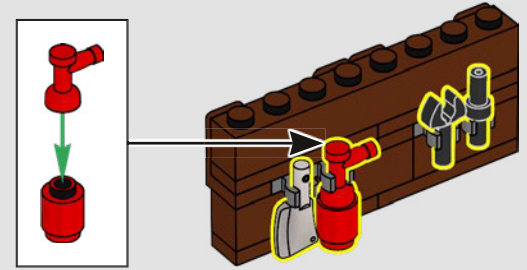

66

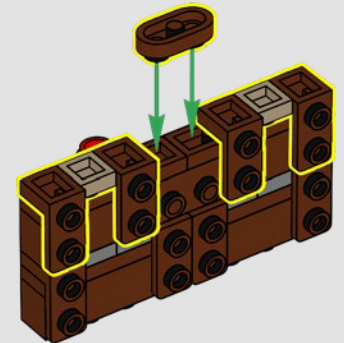

67

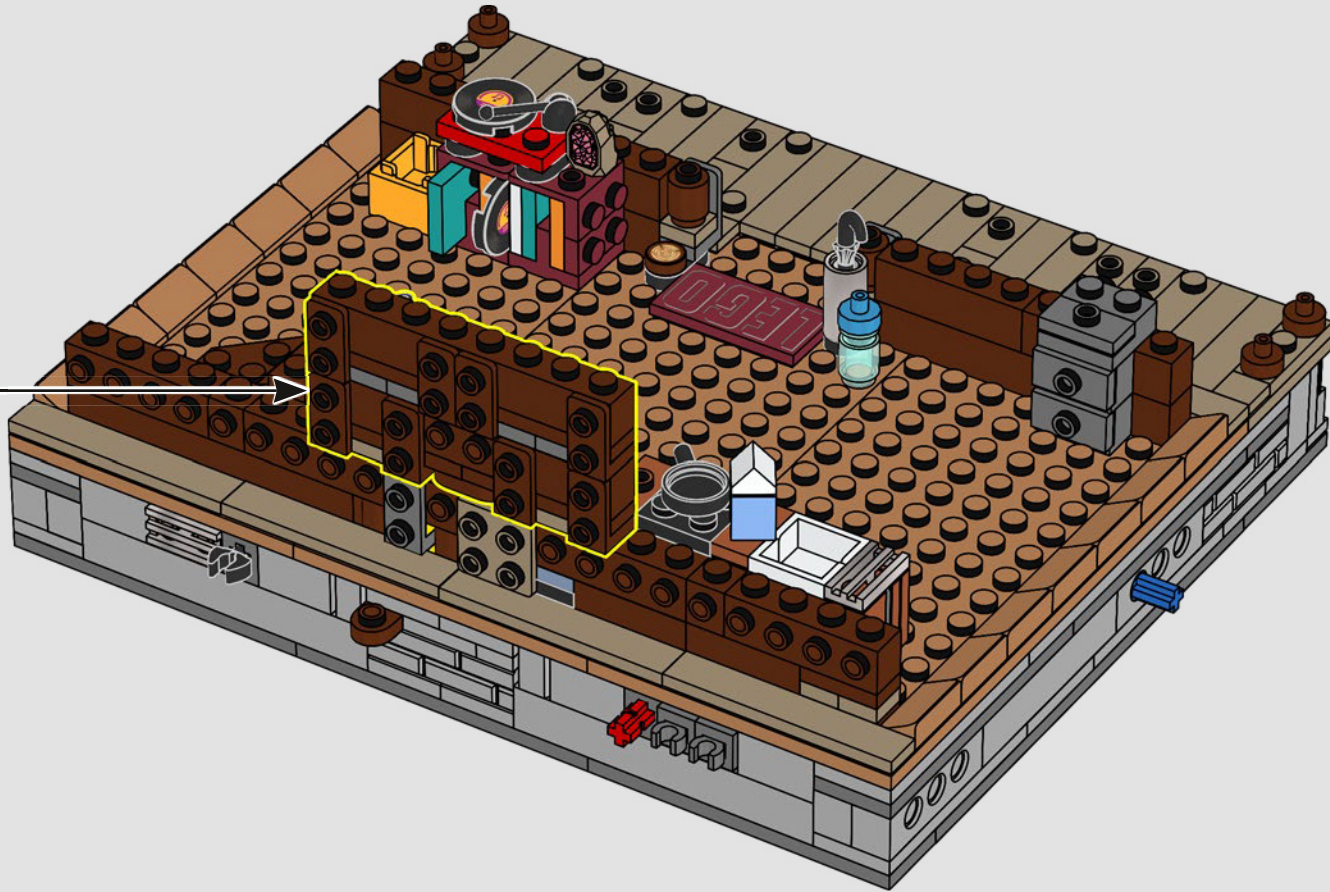

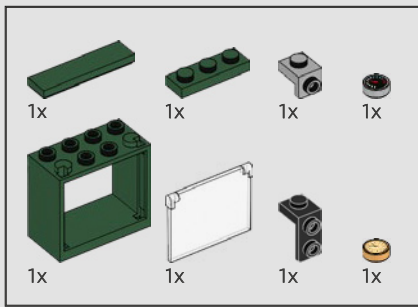

68

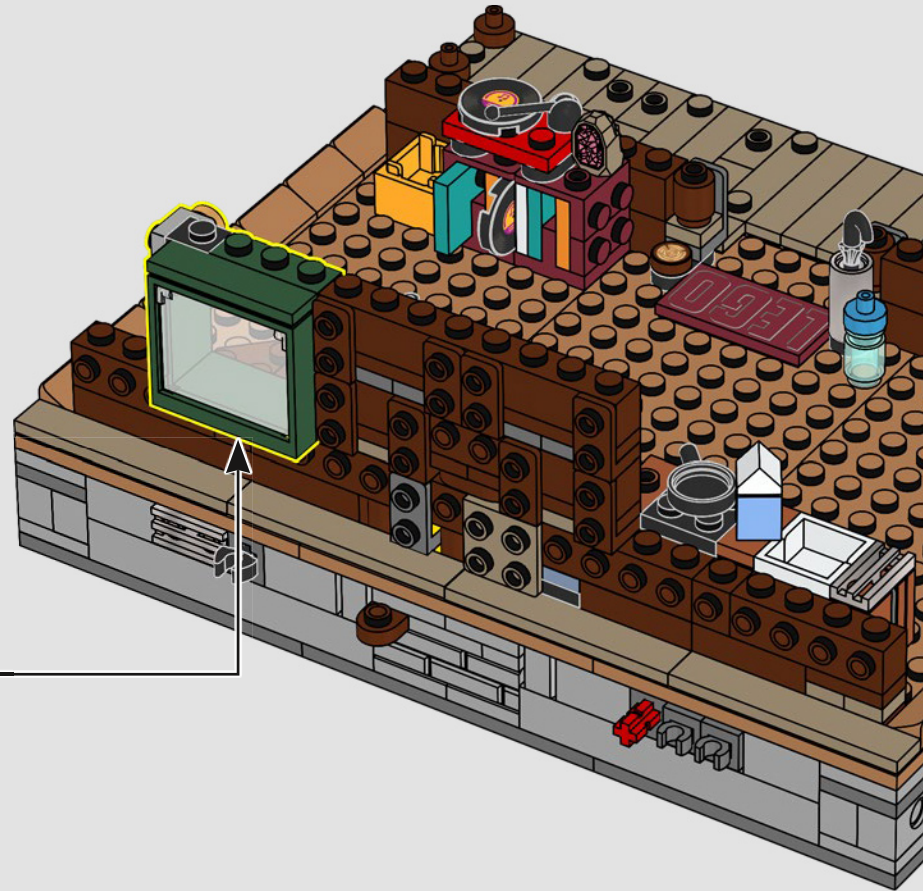
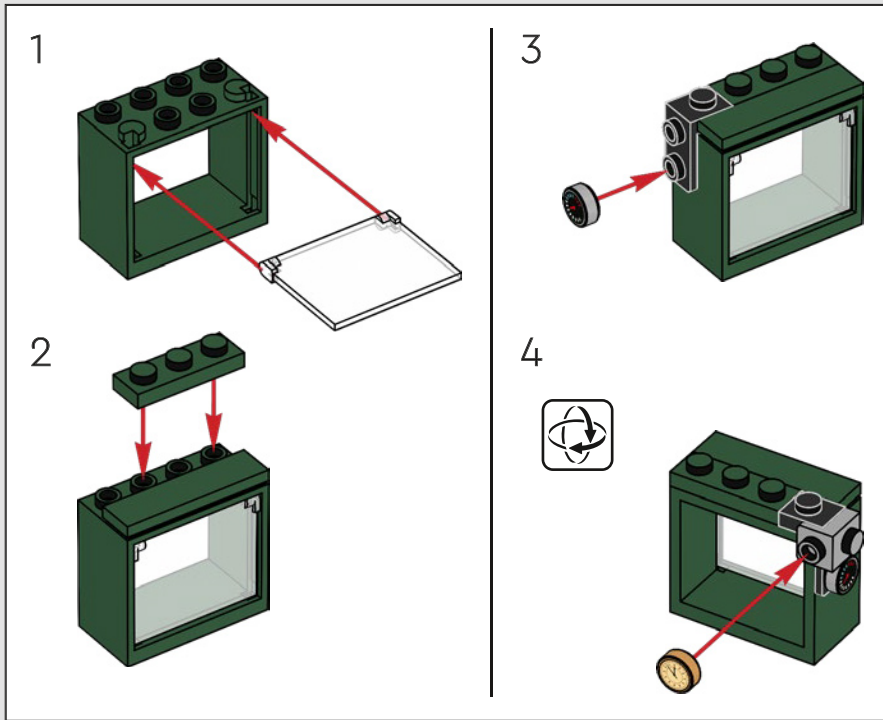



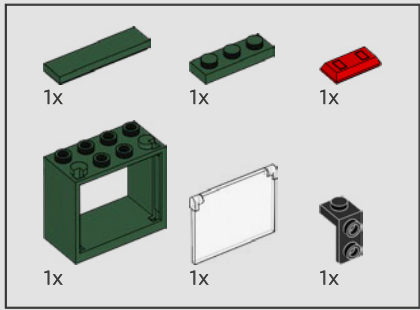

69

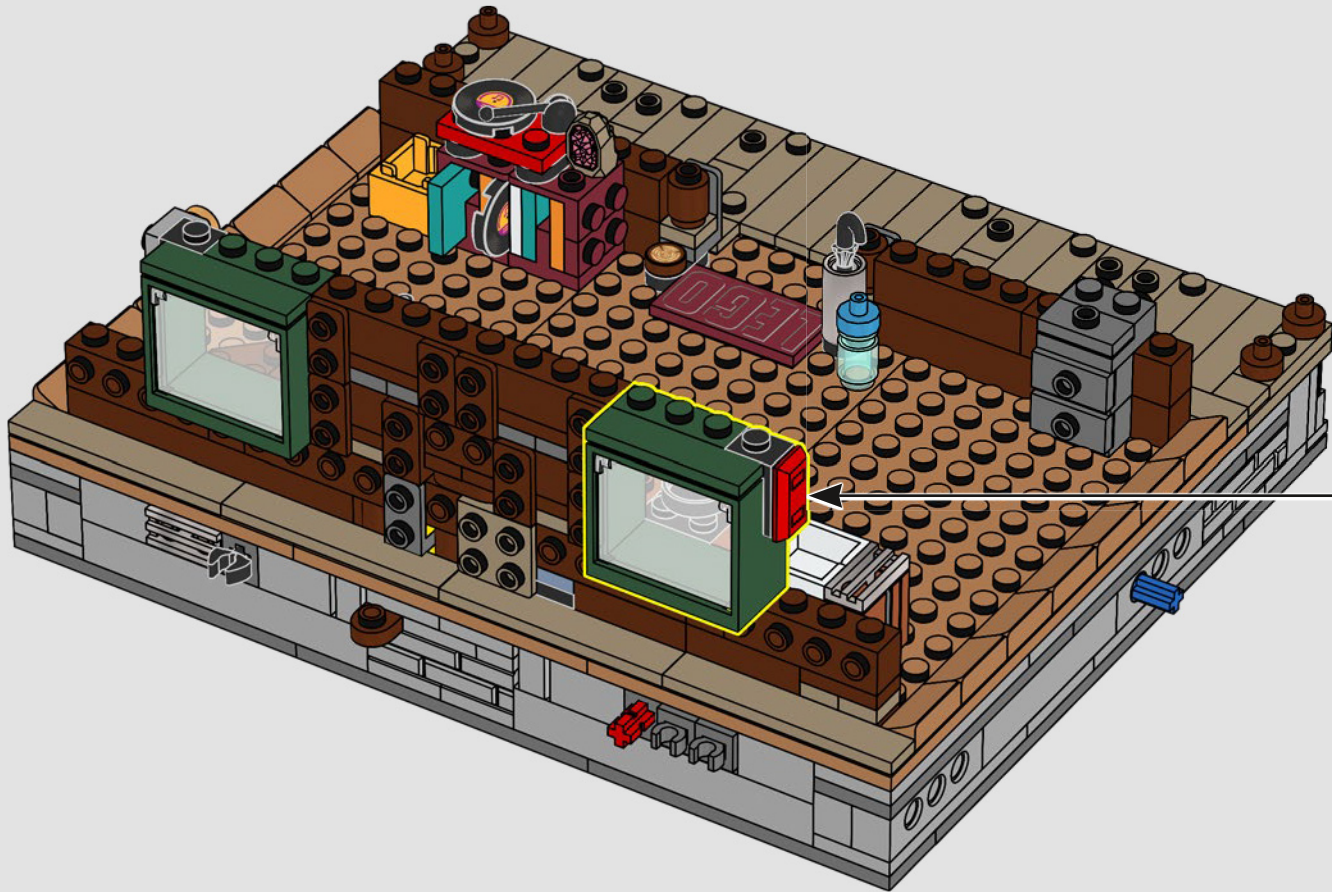
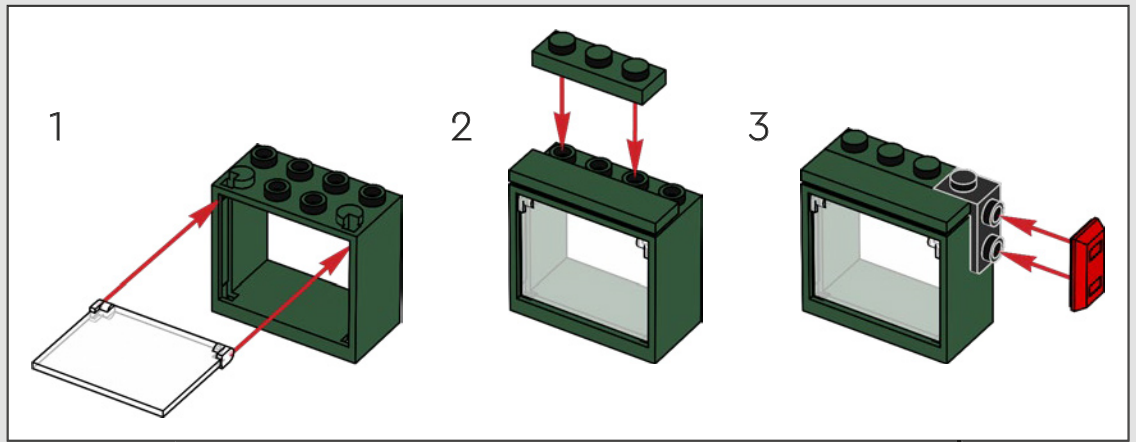

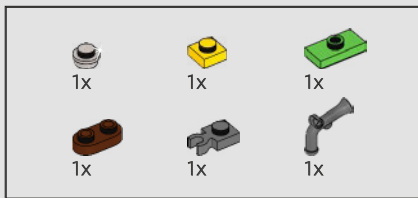

70

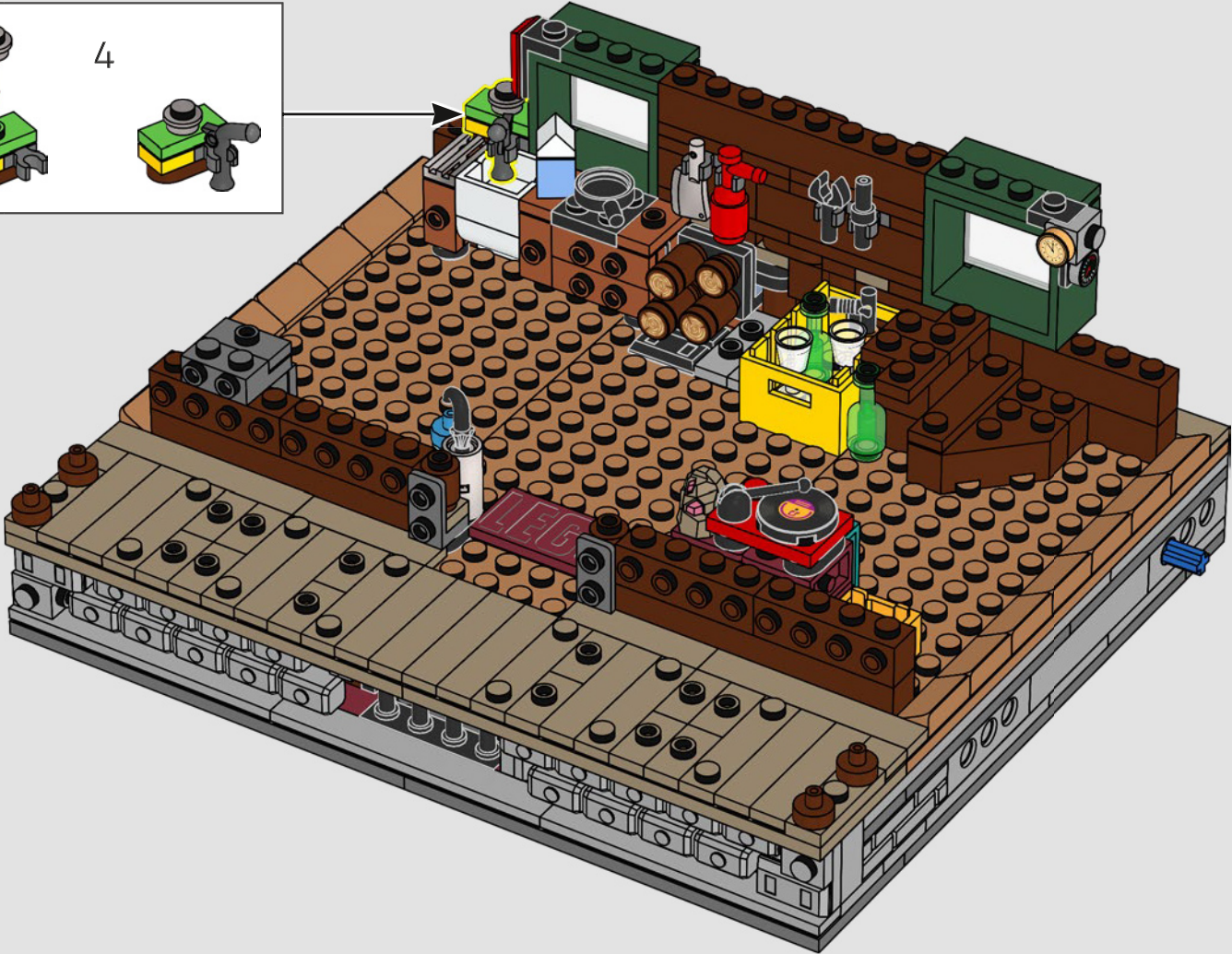
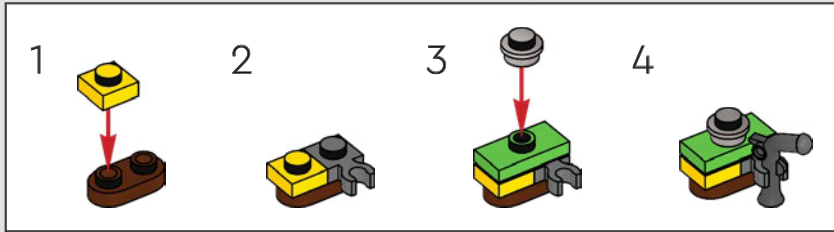





71

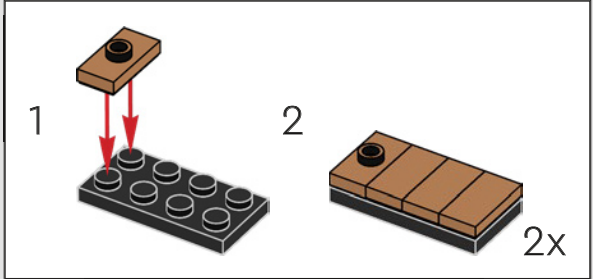
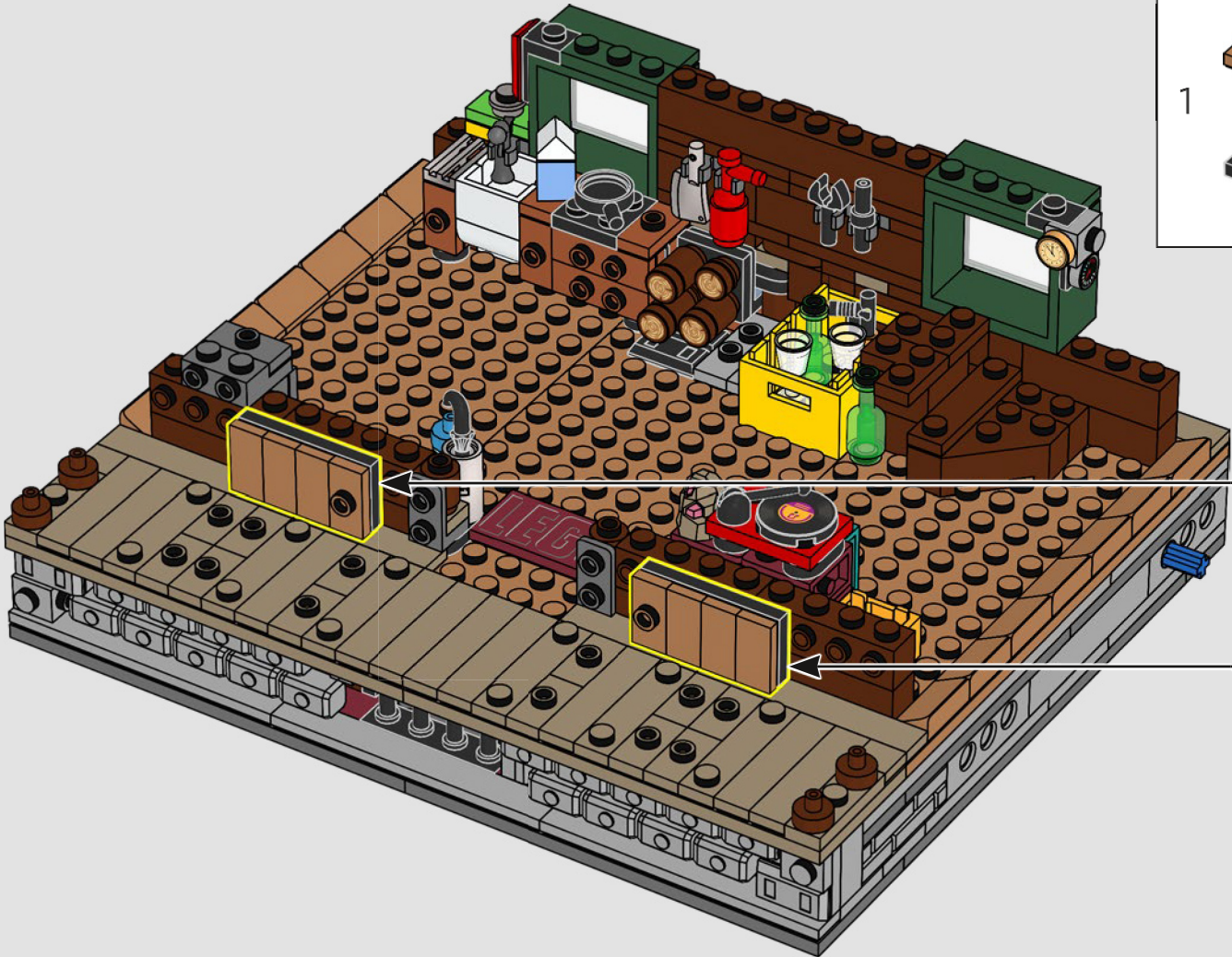



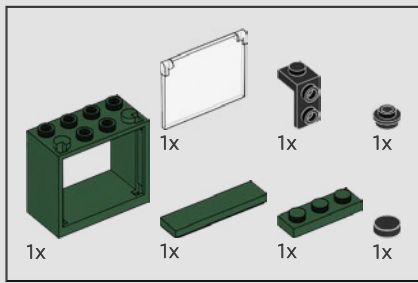

72

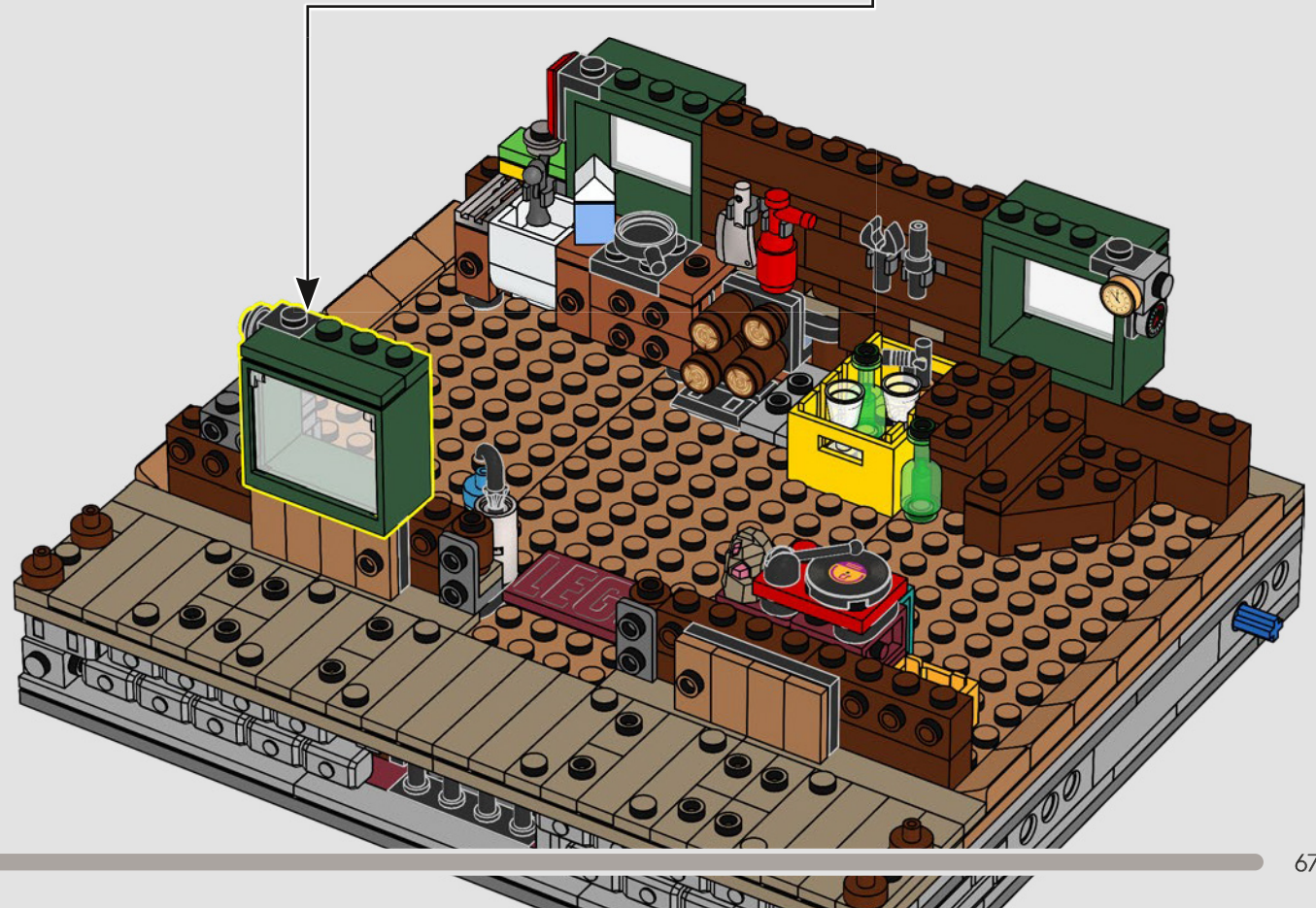
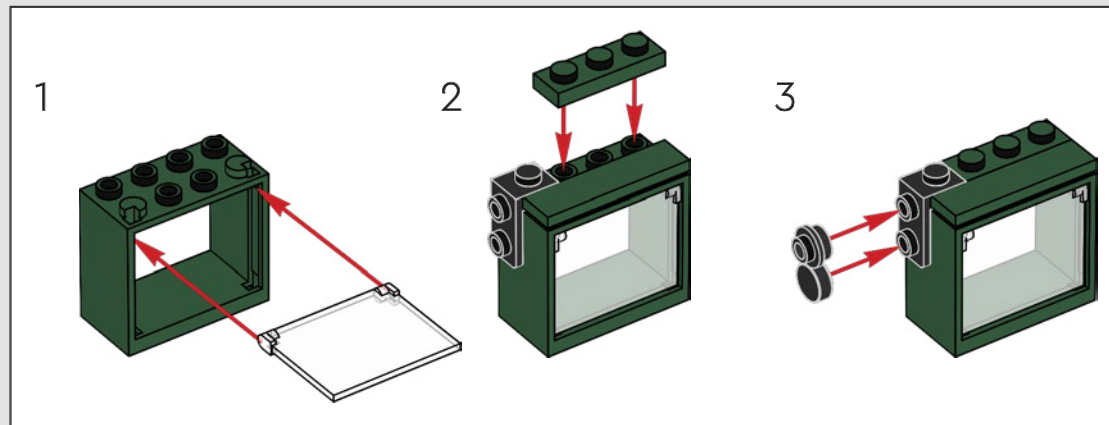

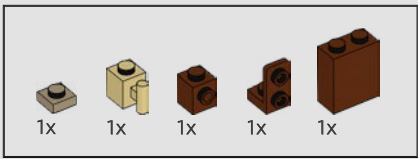

73

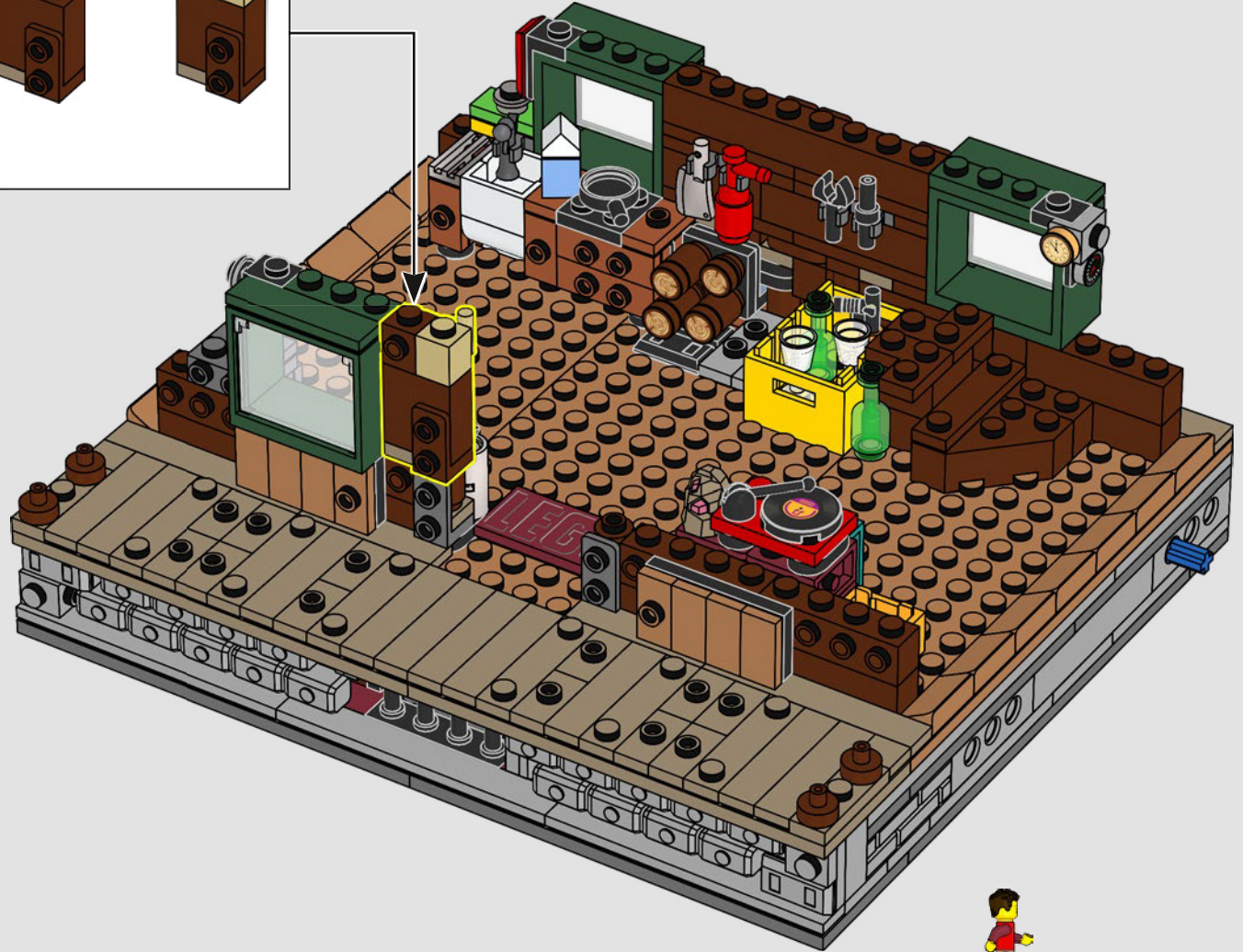
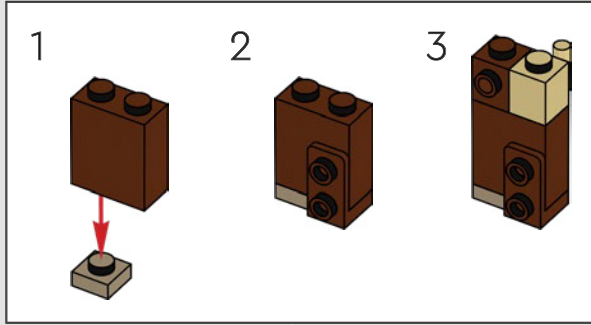



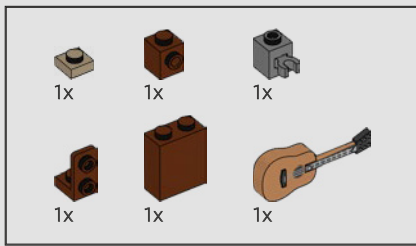

74

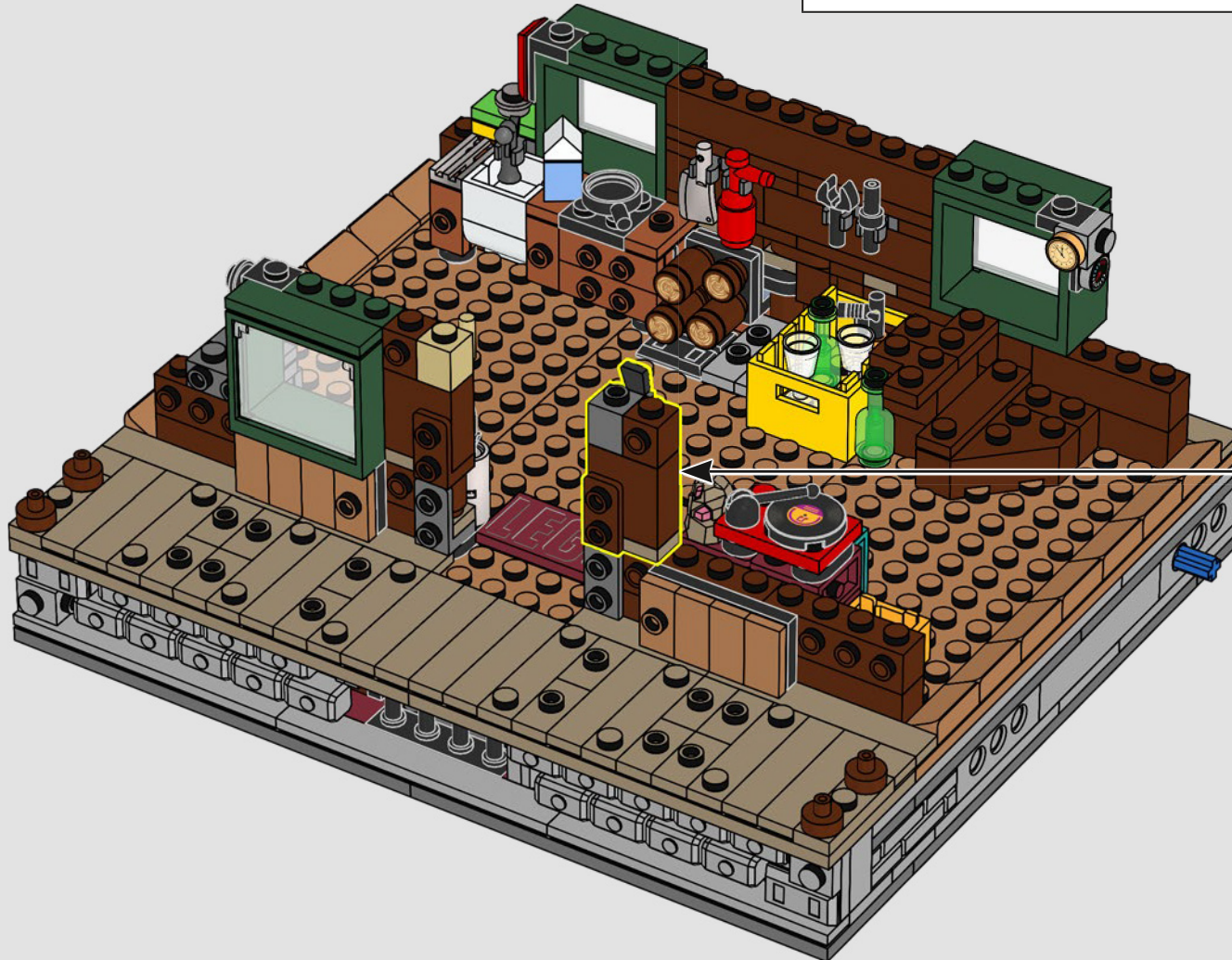
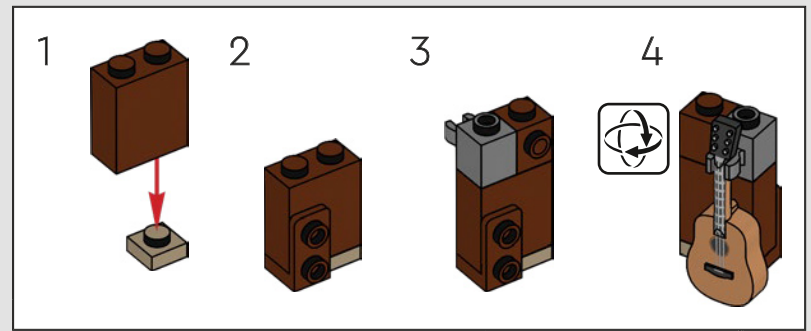



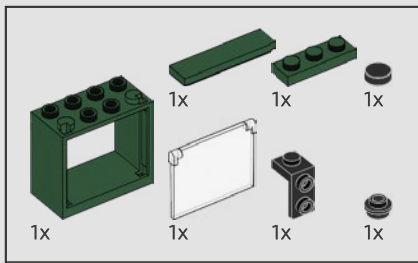

75

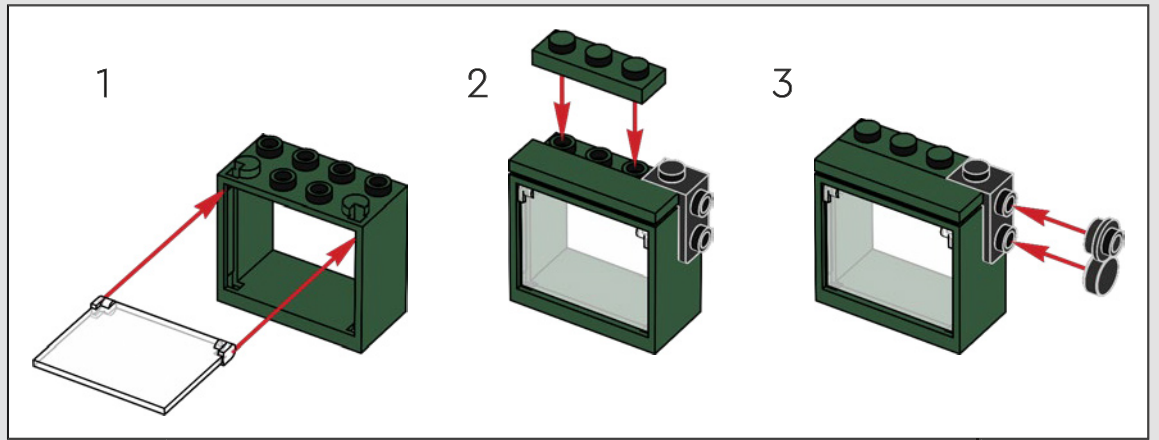

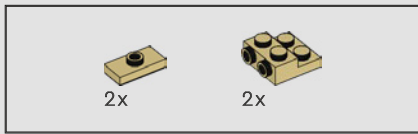

76

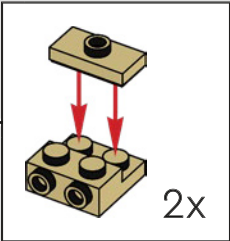
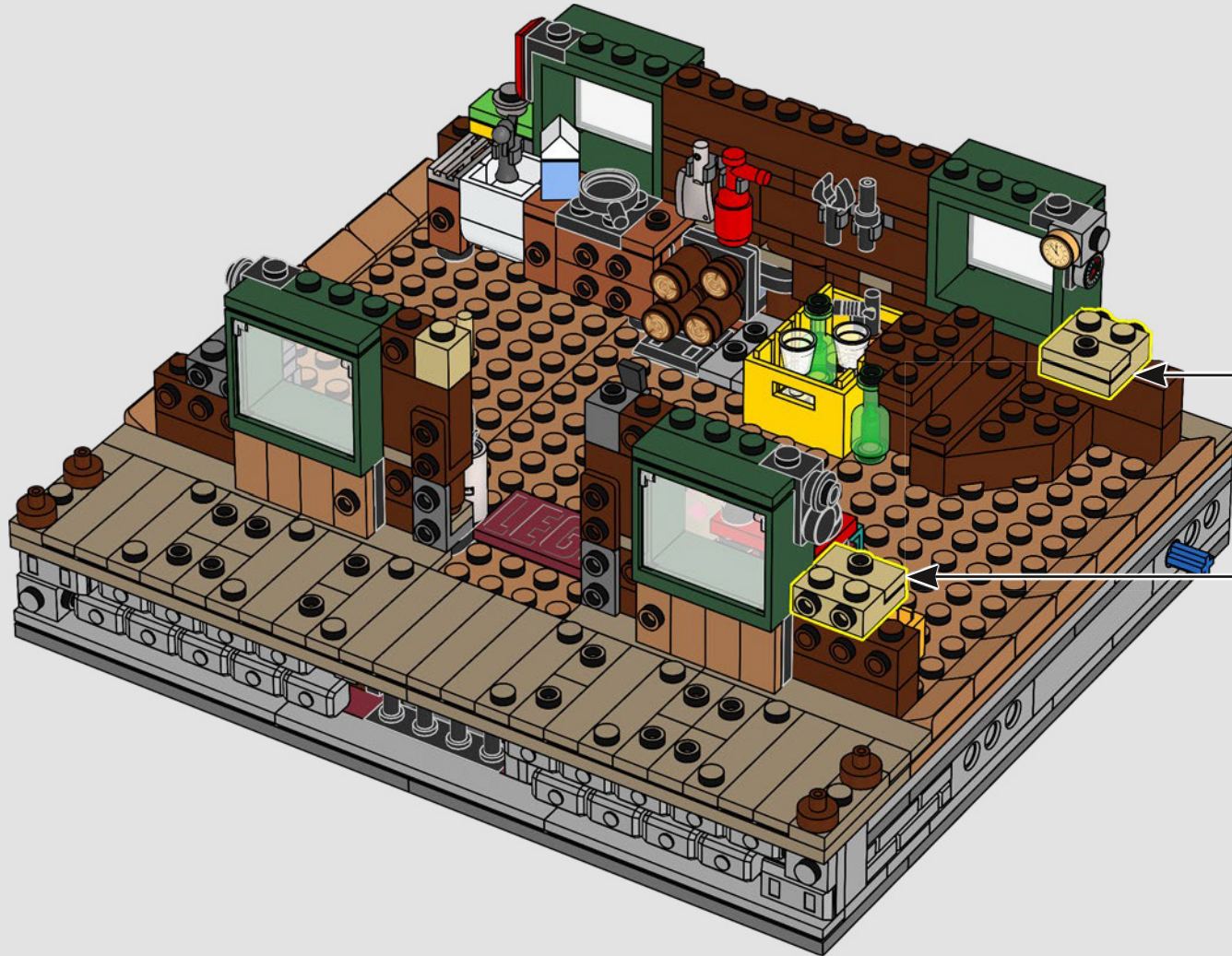



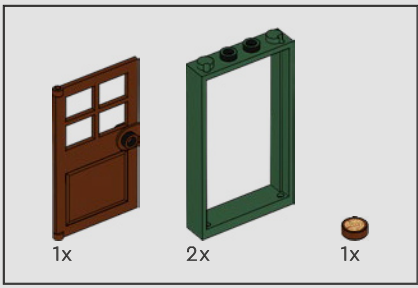

77

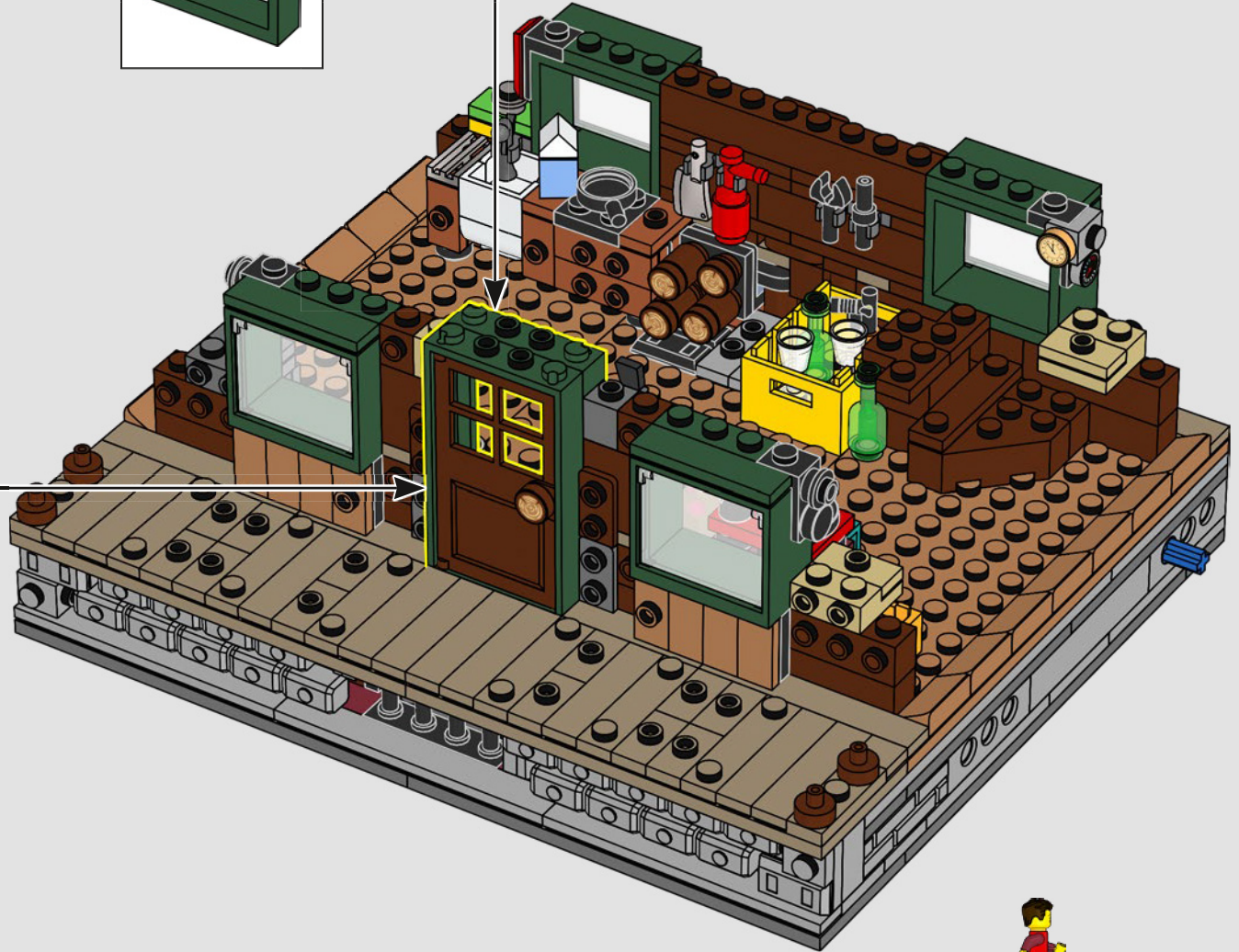
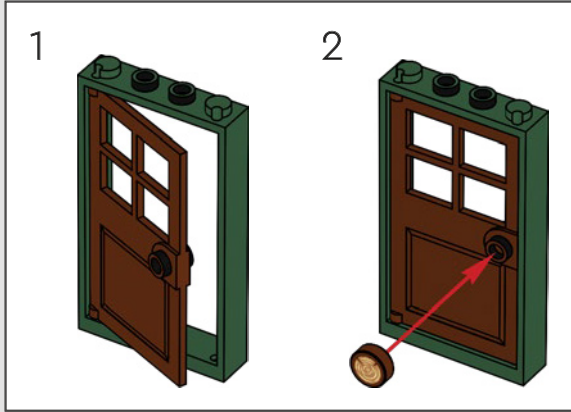
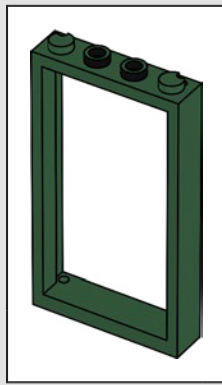

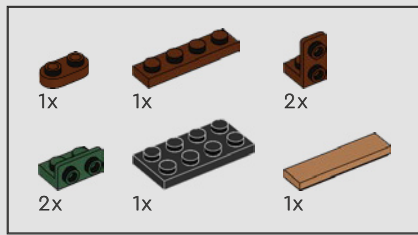

78

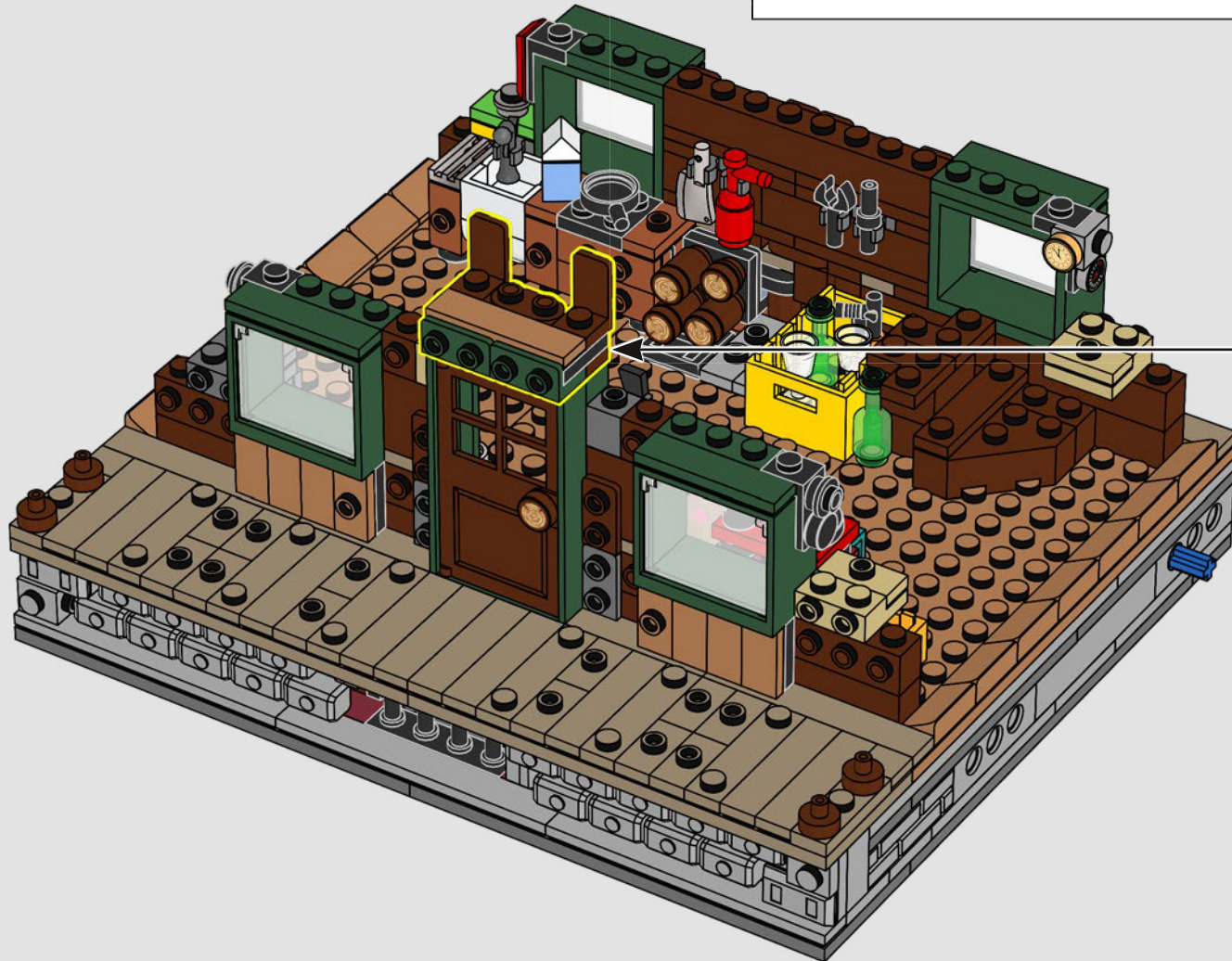
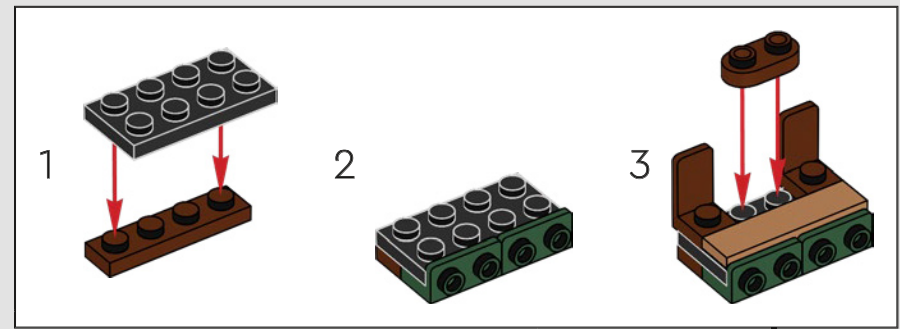



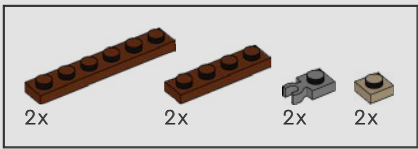

79

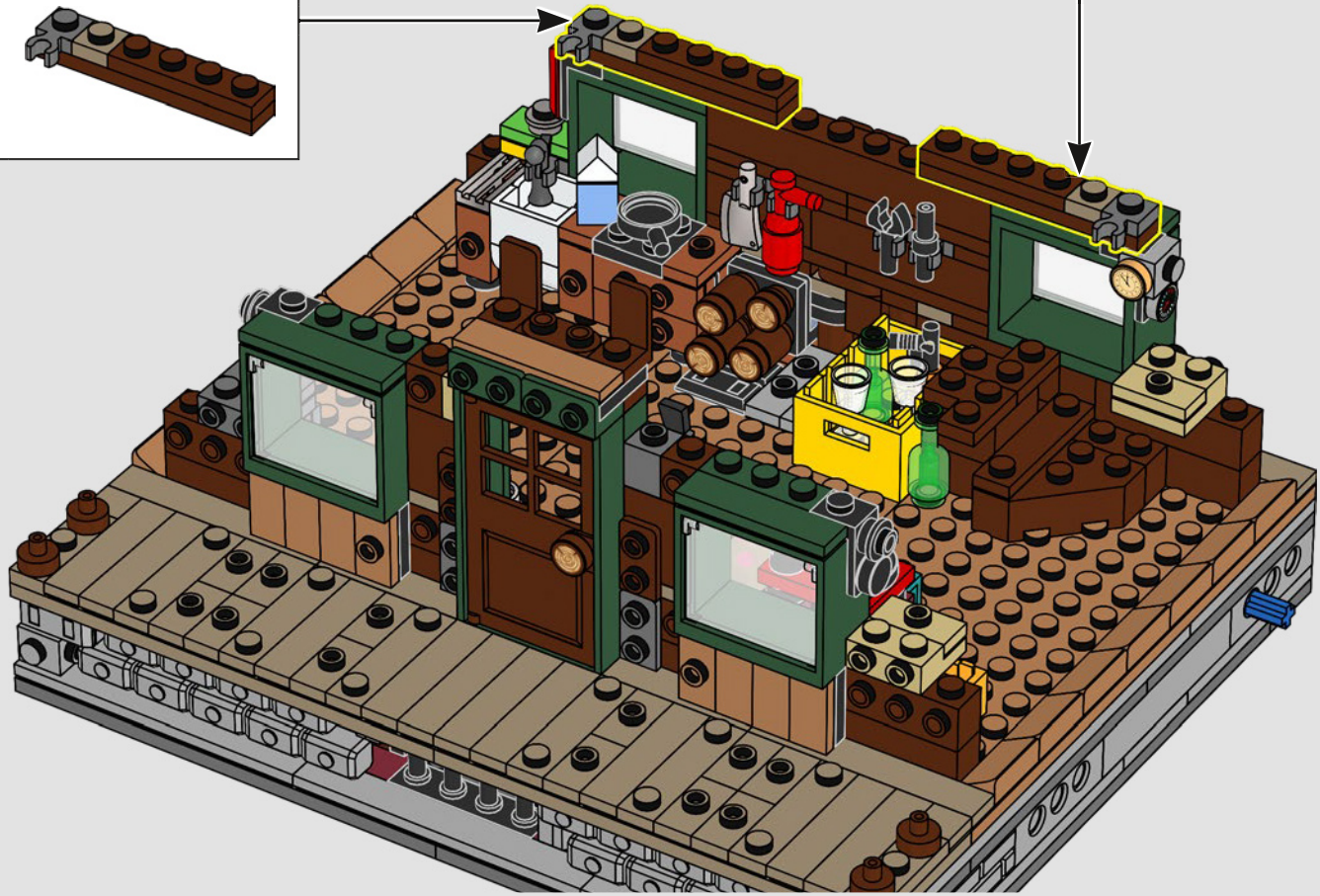
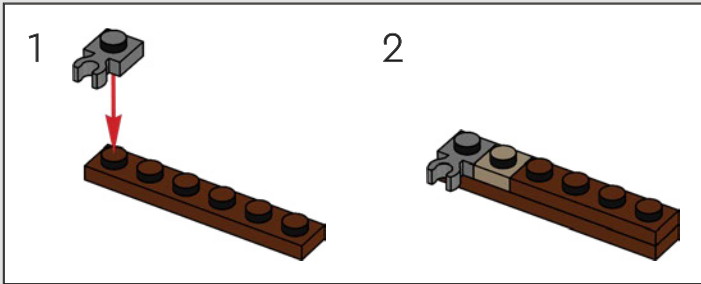
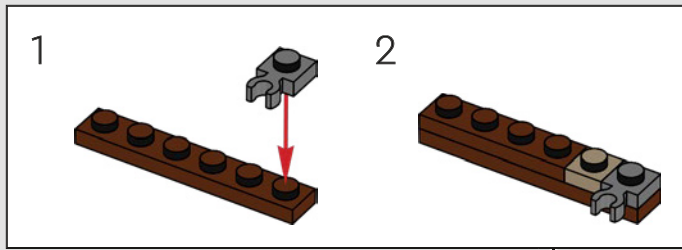

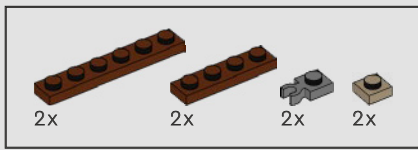

80

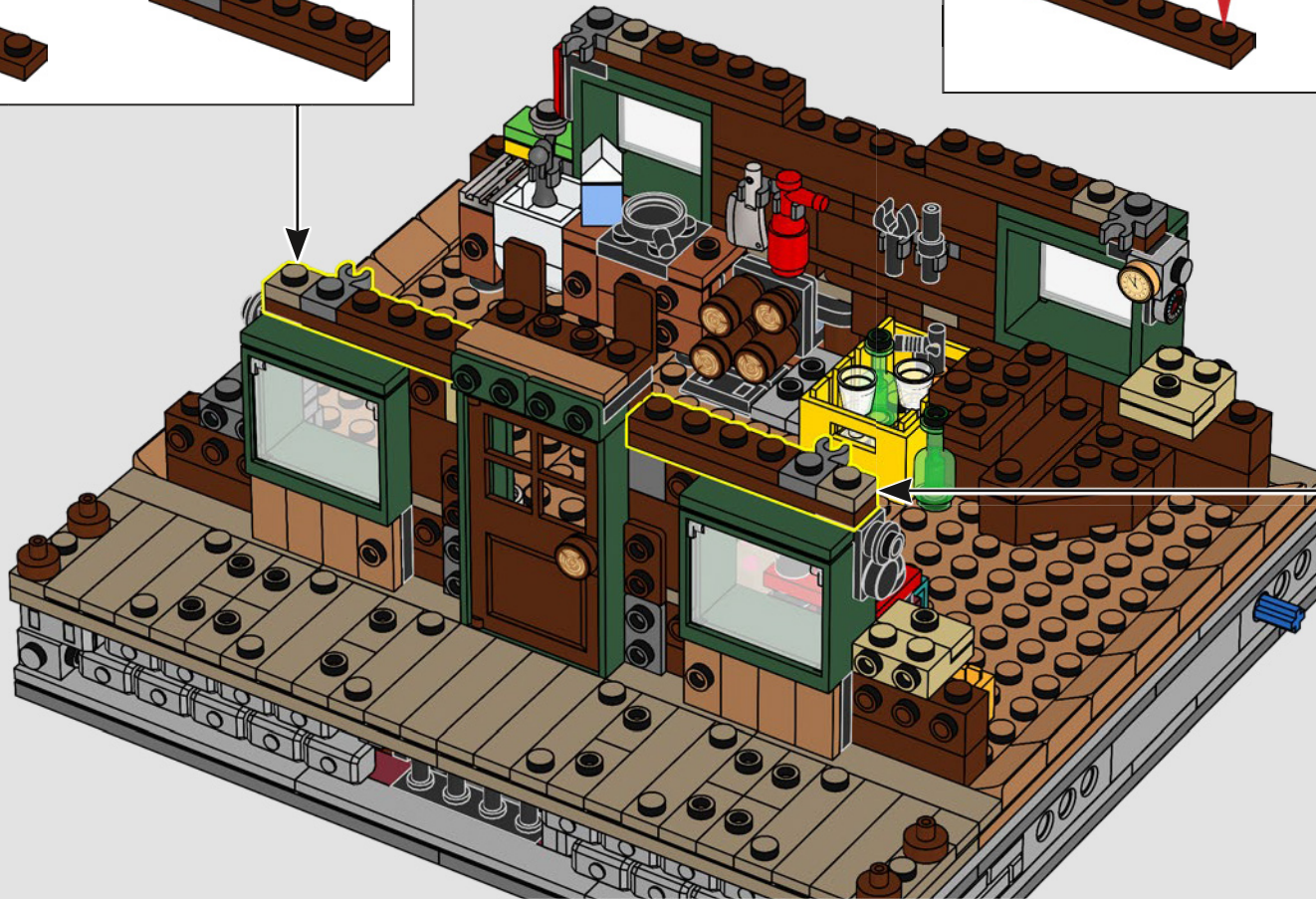
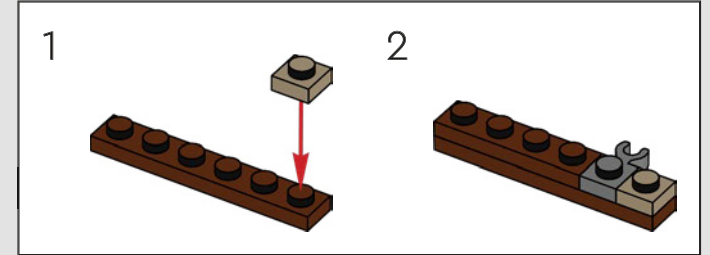
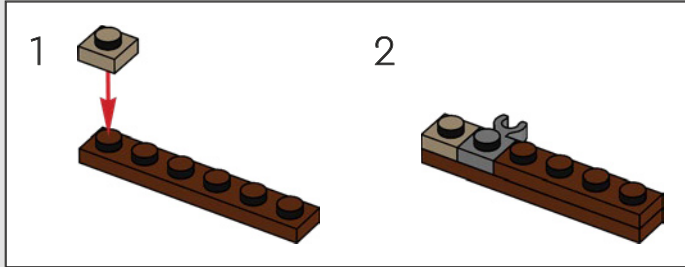



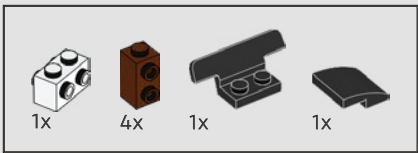

81

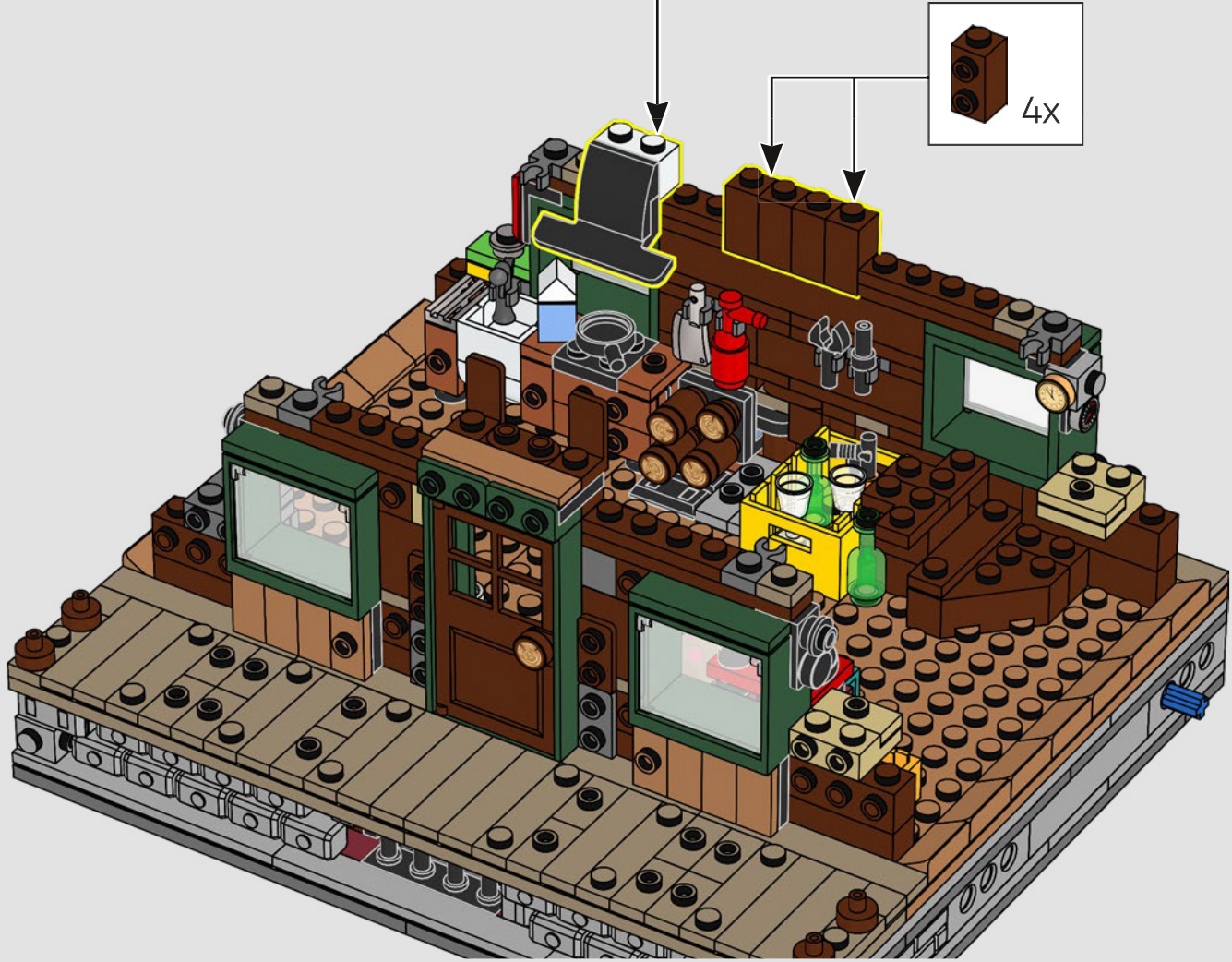
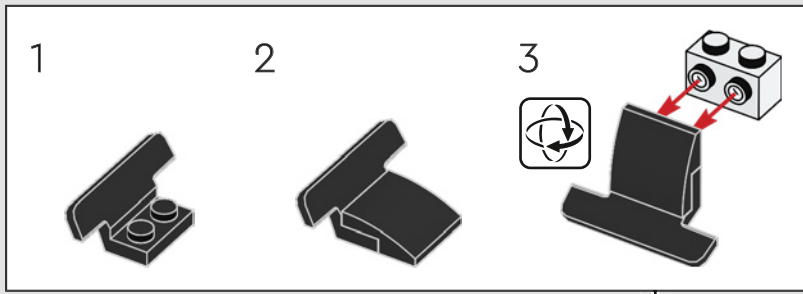



82

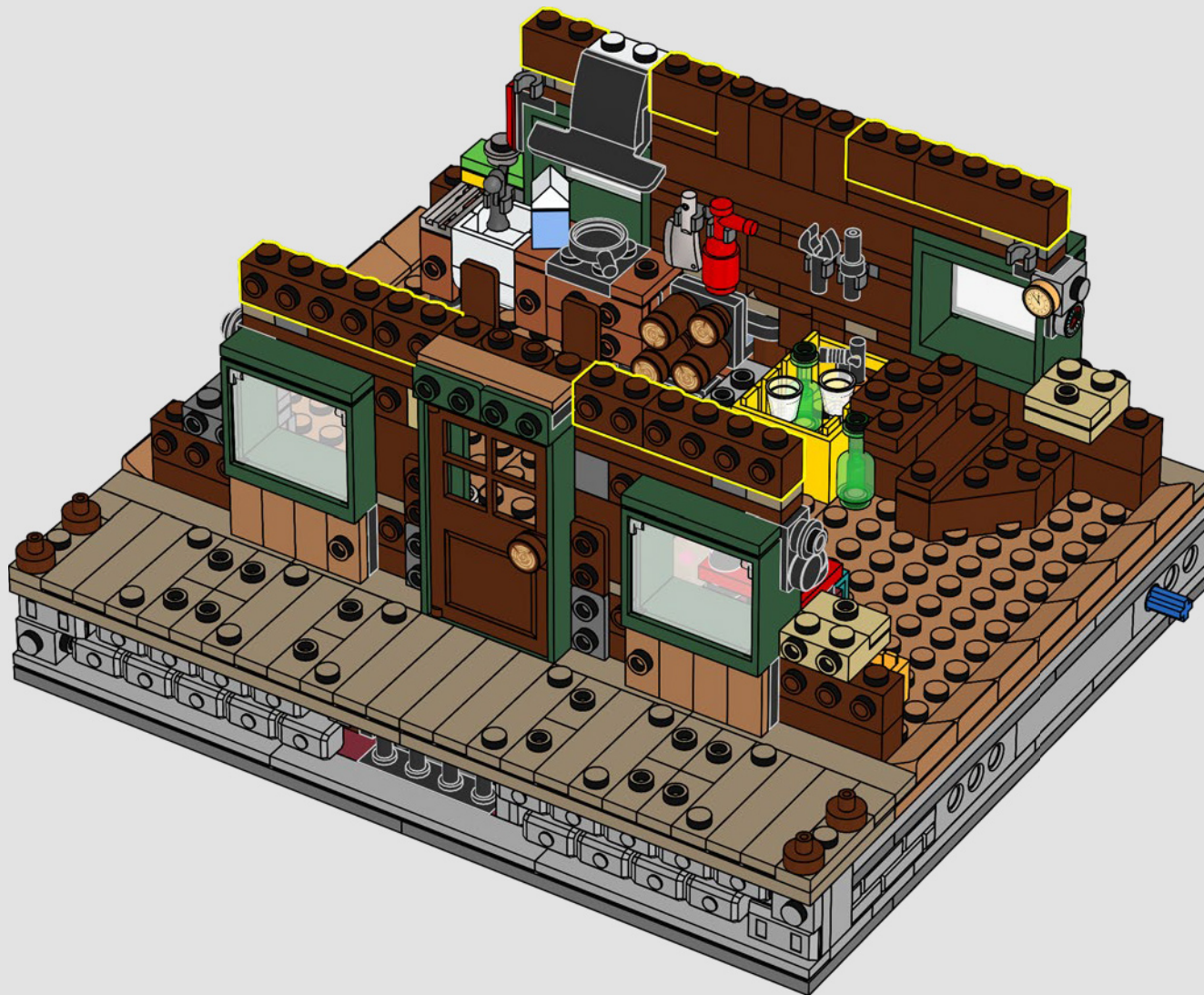



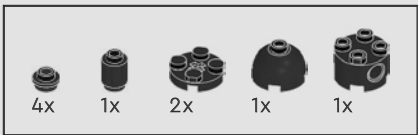

83

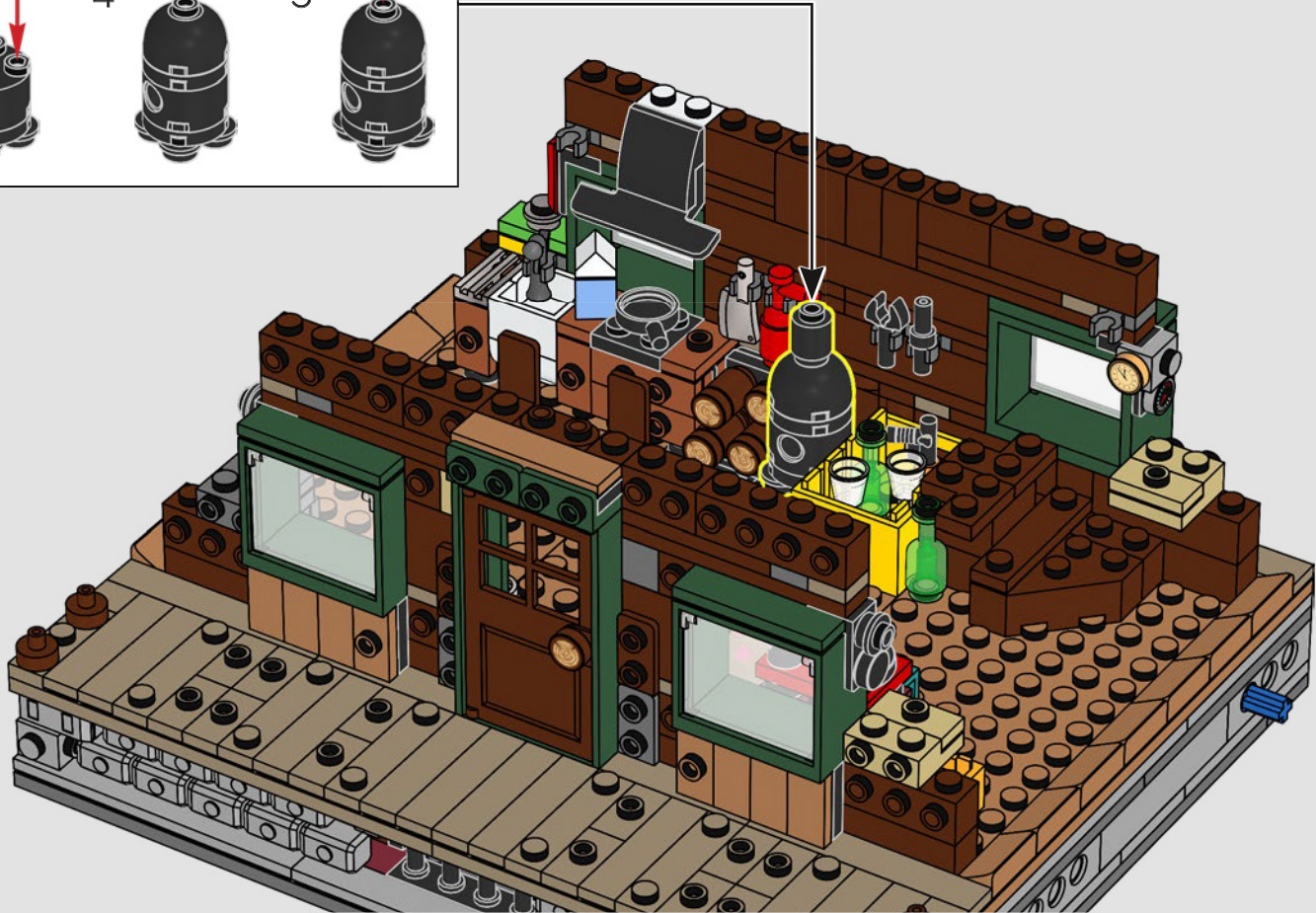
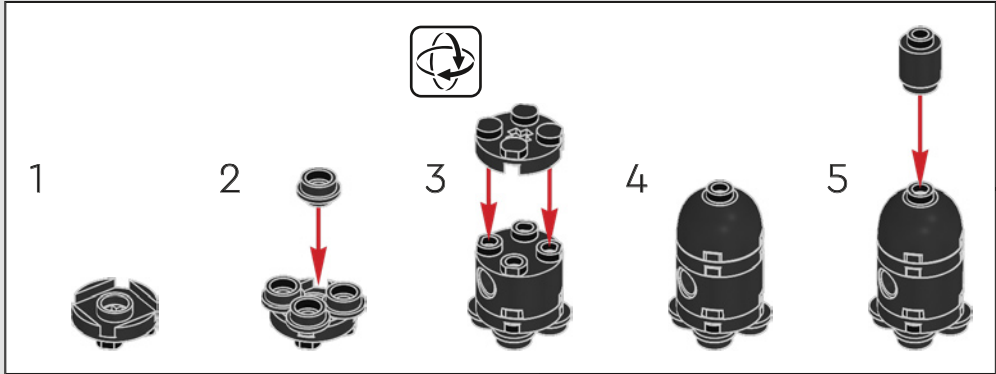

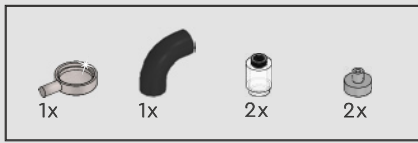

84

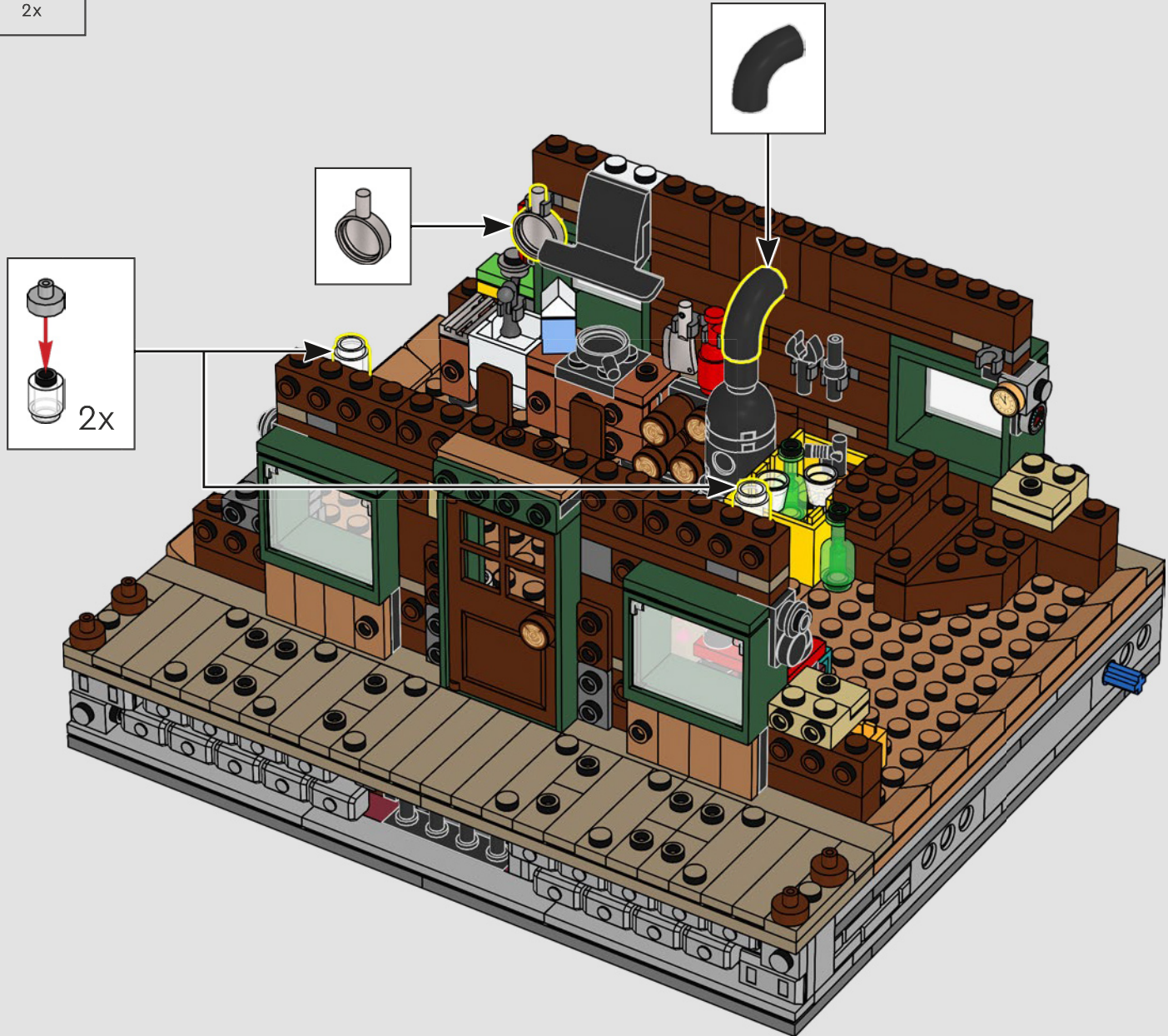



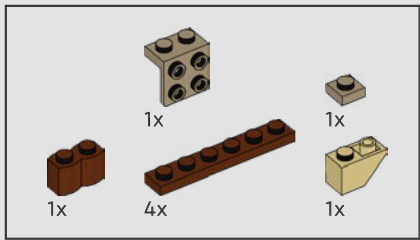

85

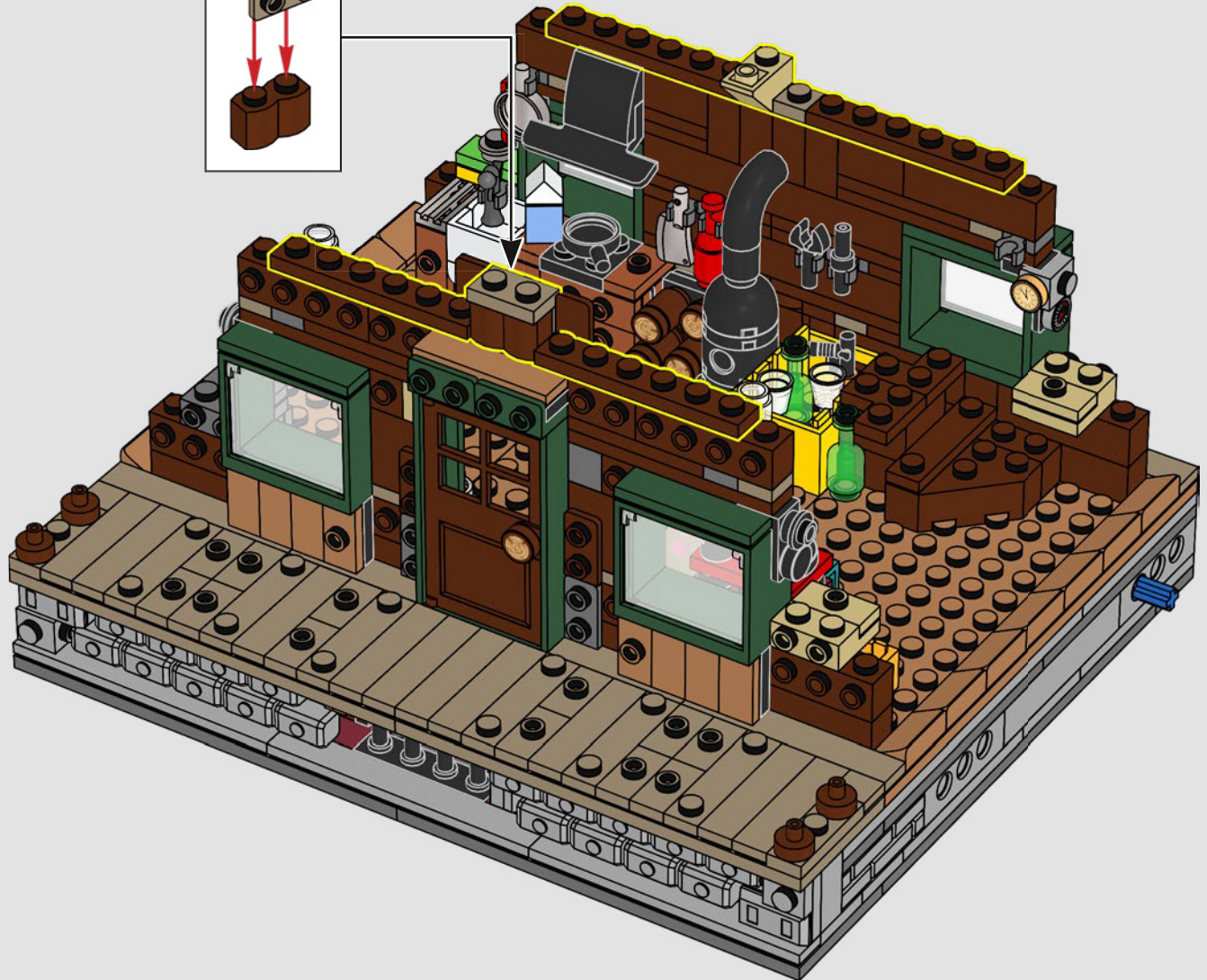
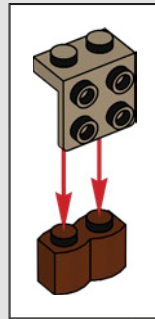

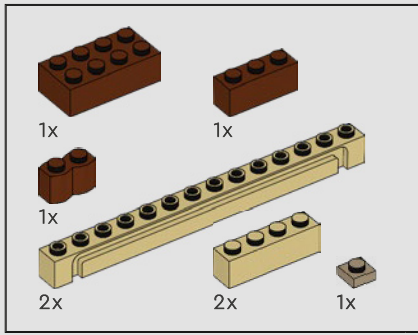

86

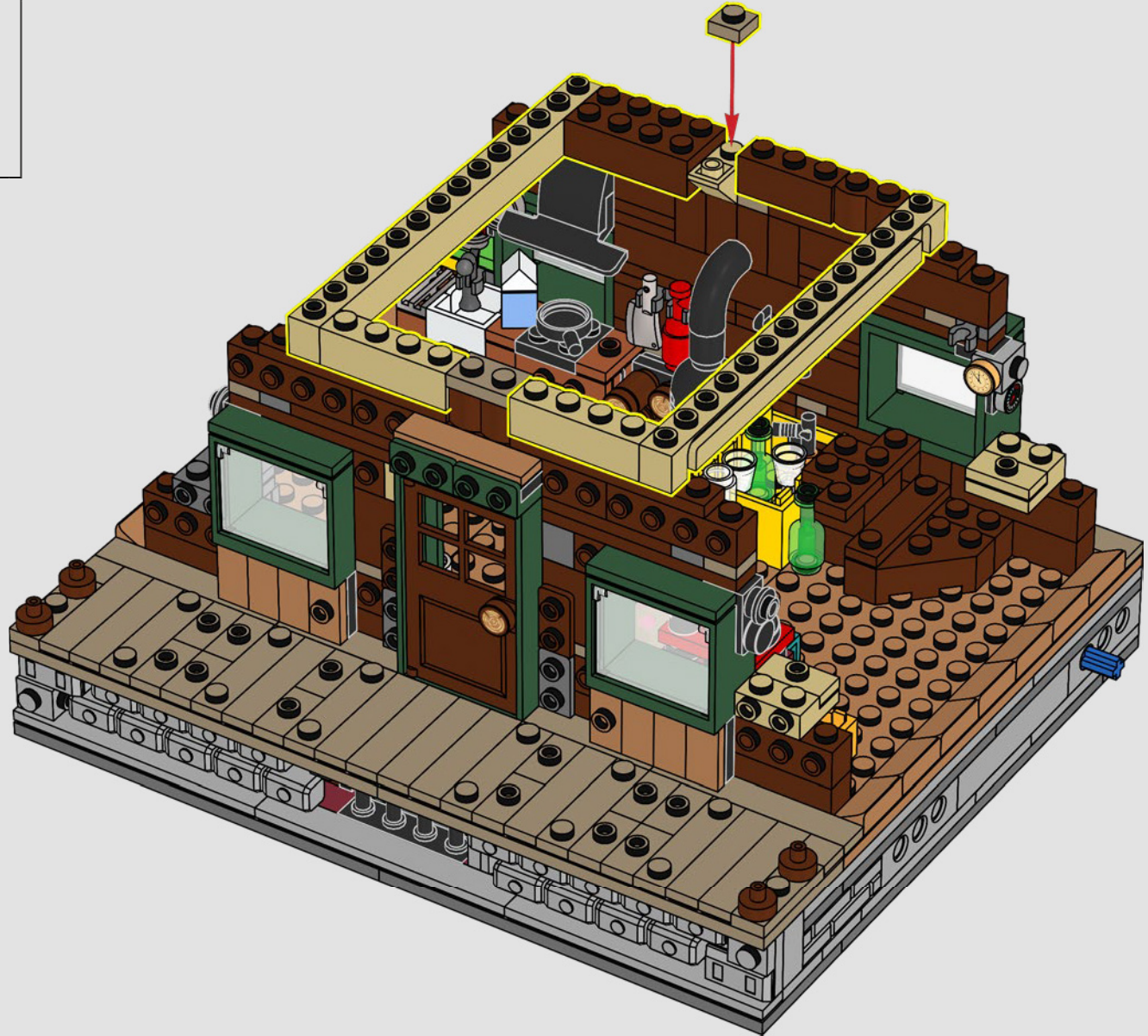



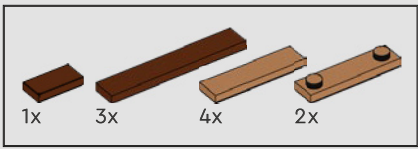

87

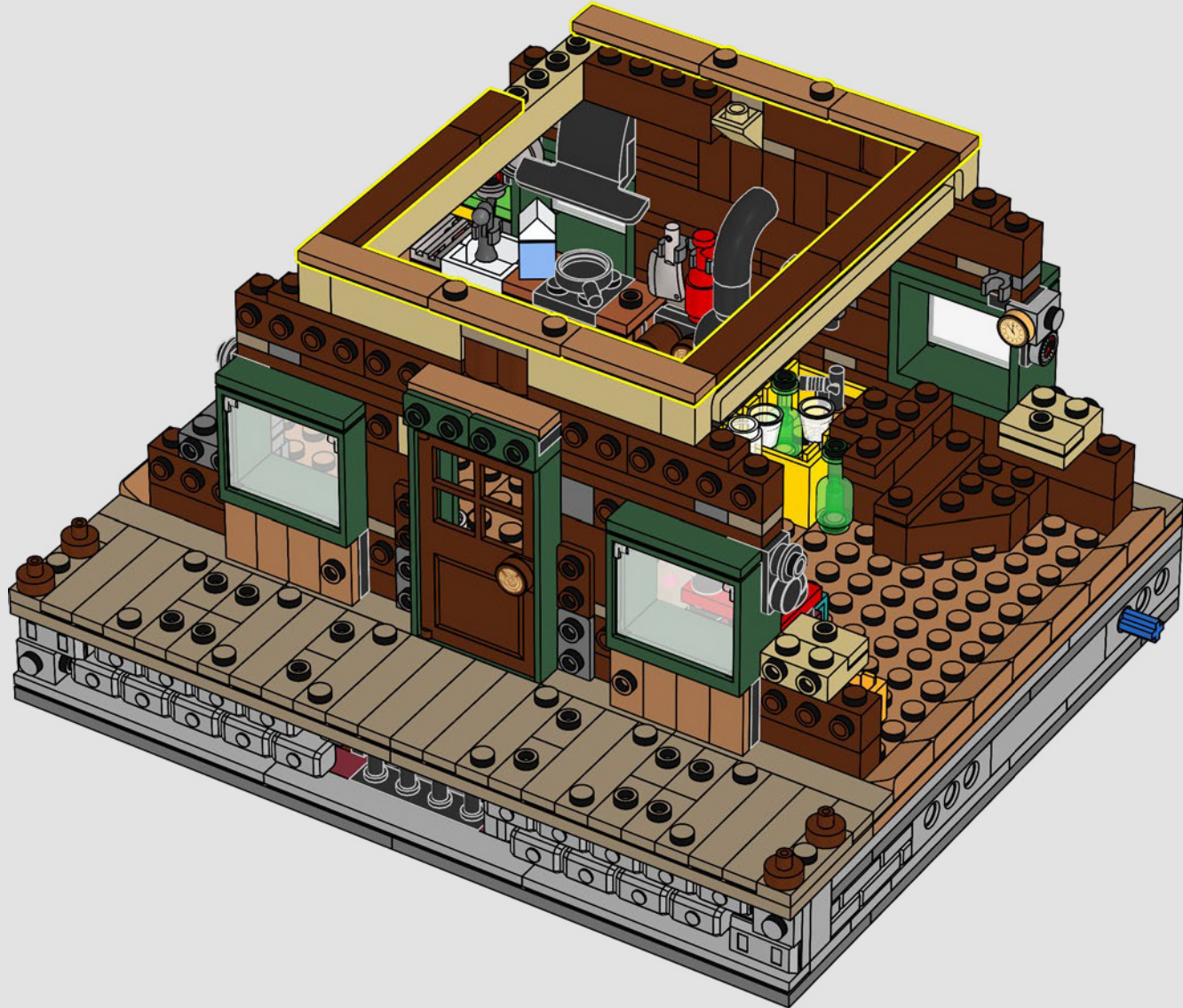

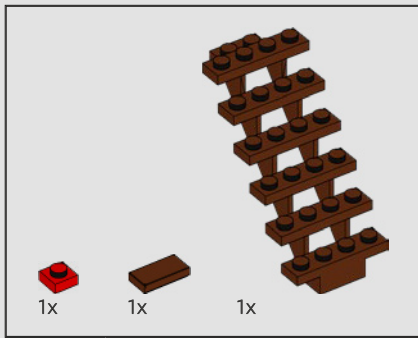



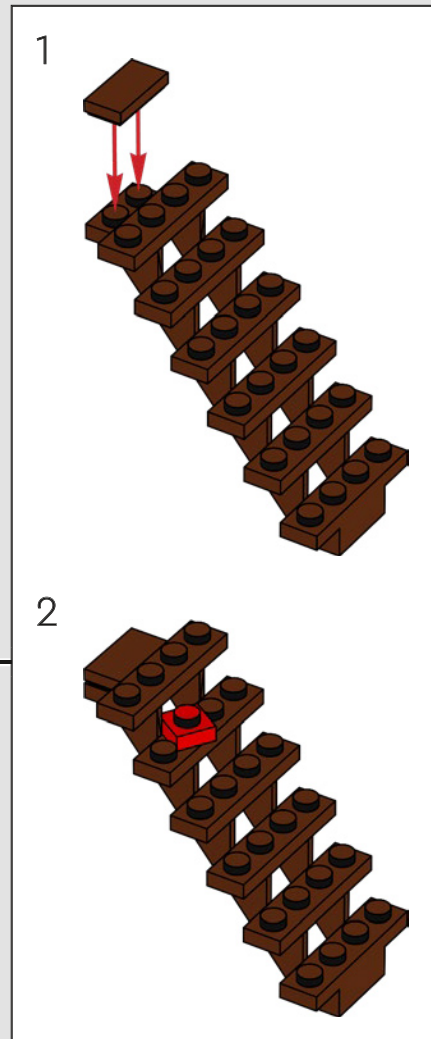
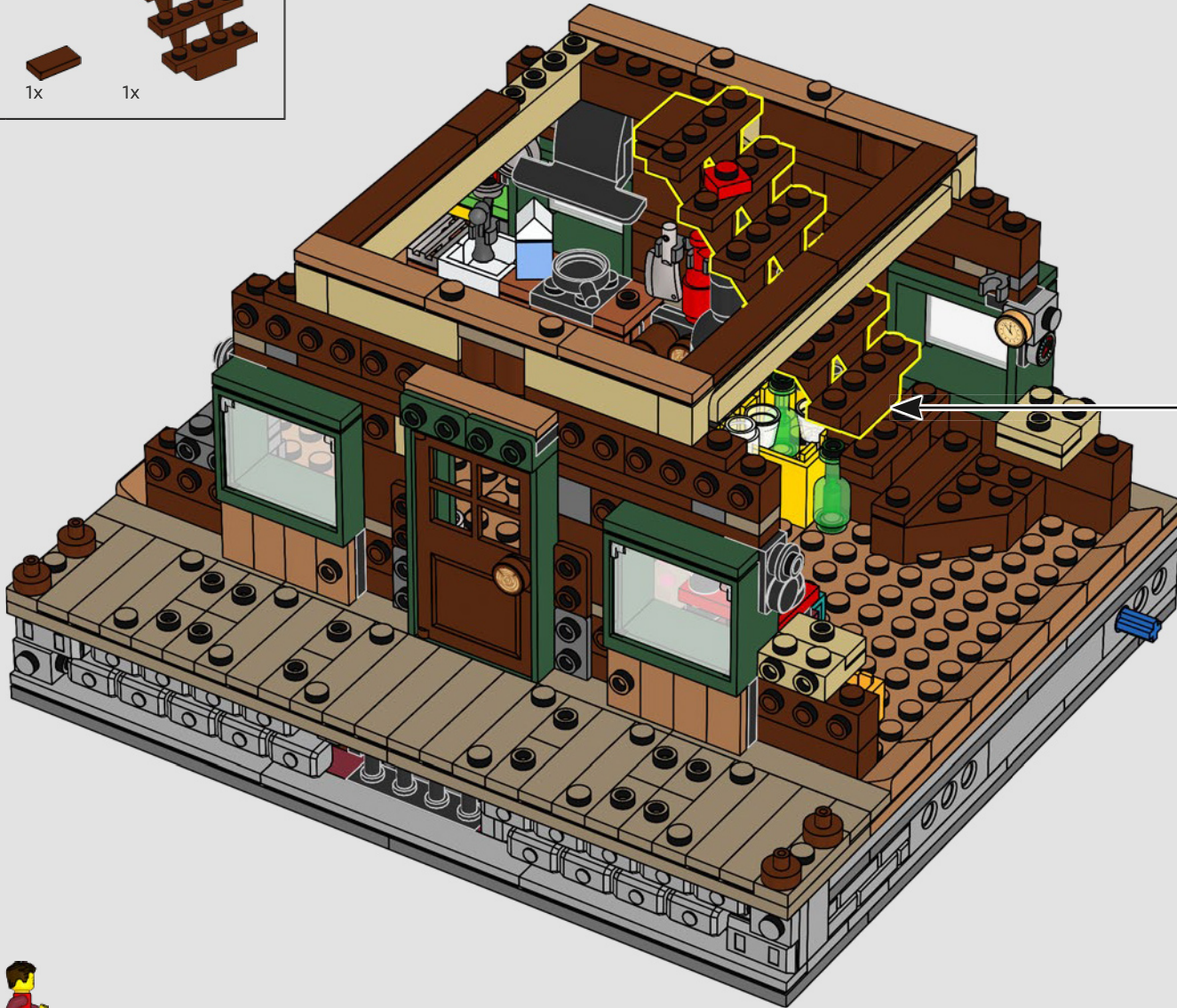

88





- 4x 
- 4x 
- 1x 
- 1x 

89

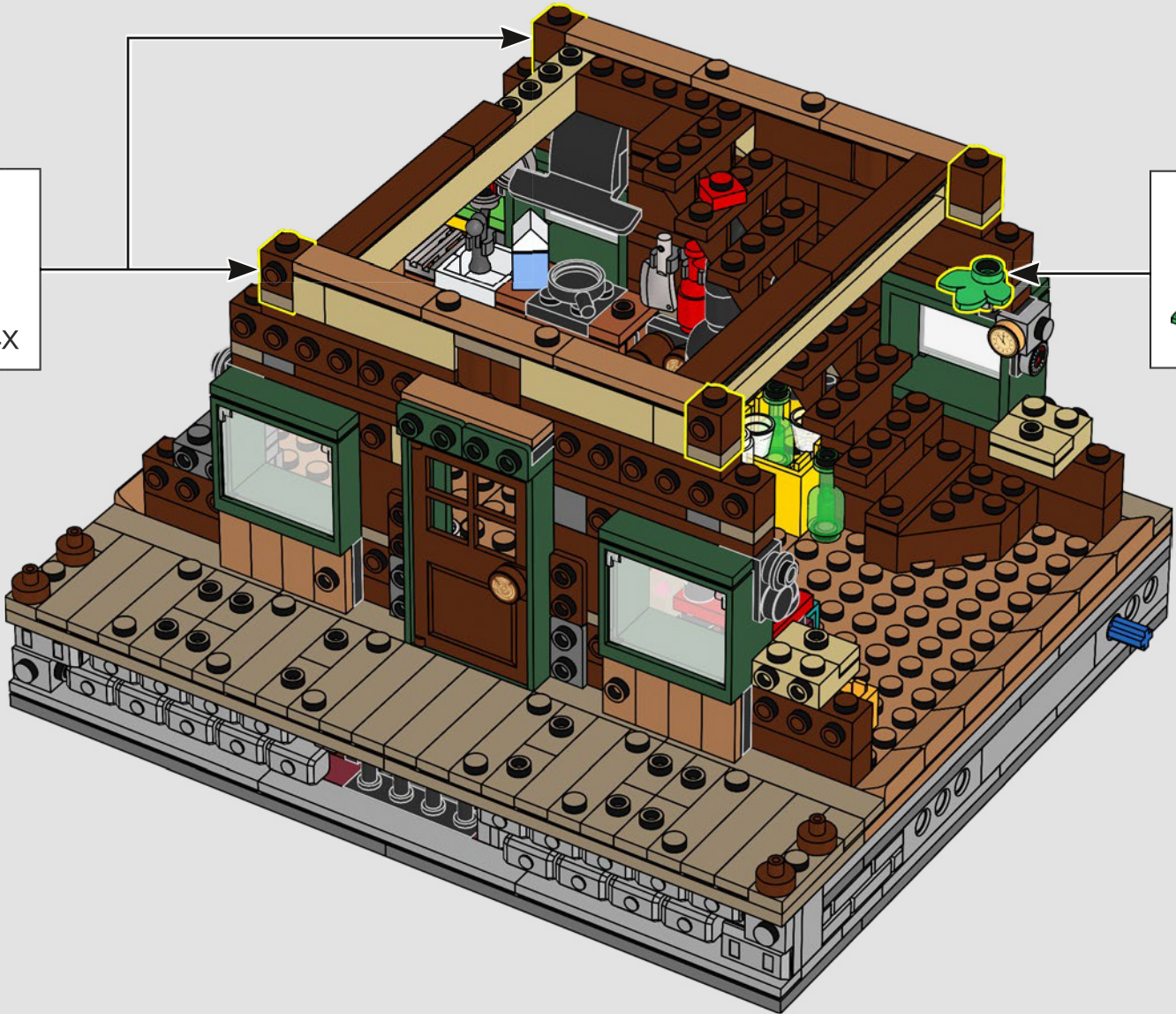
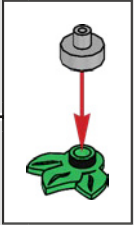
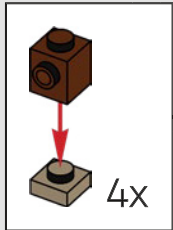

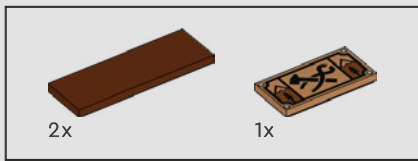

90

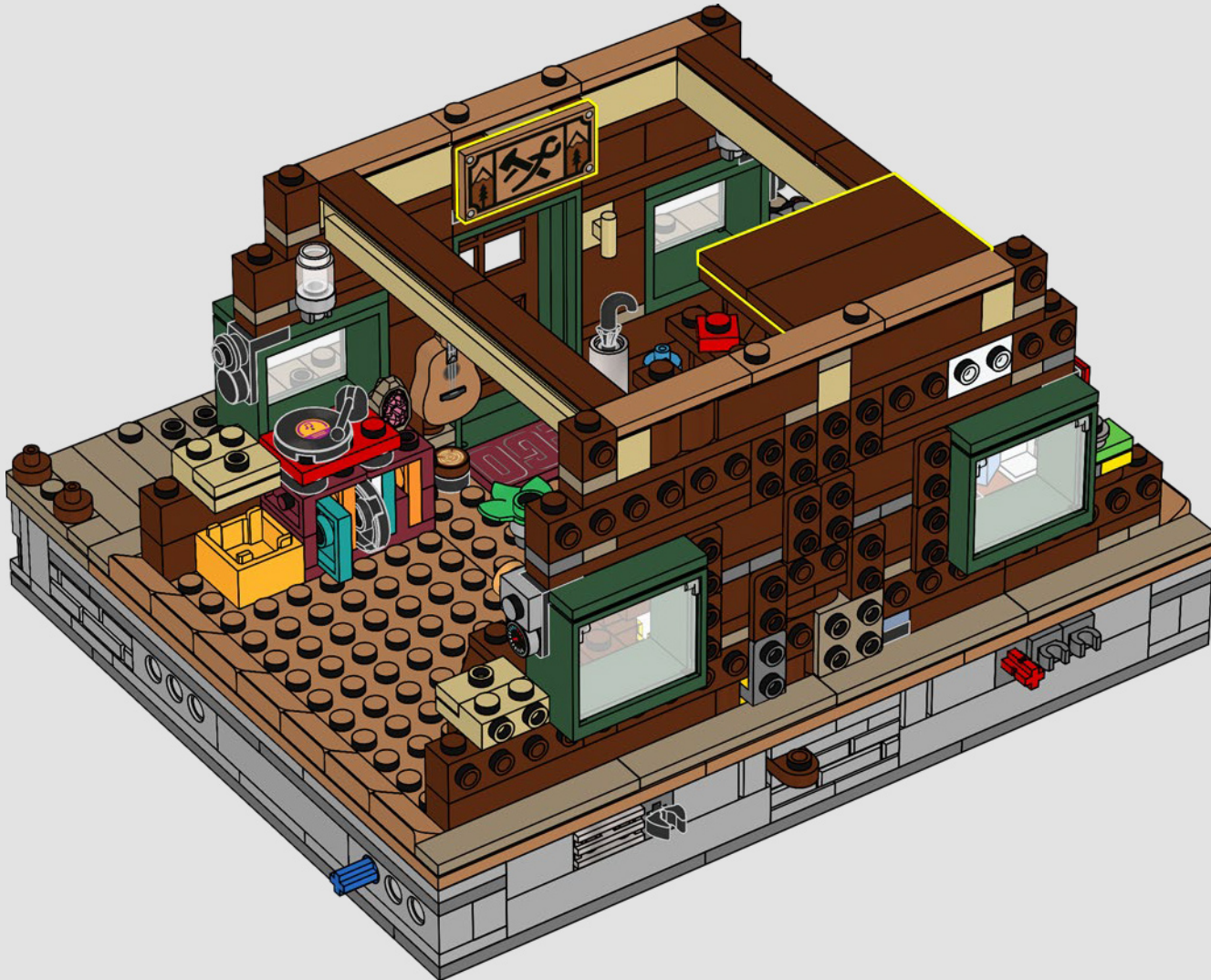





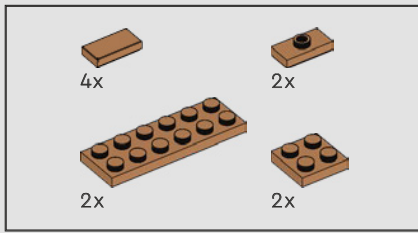

91

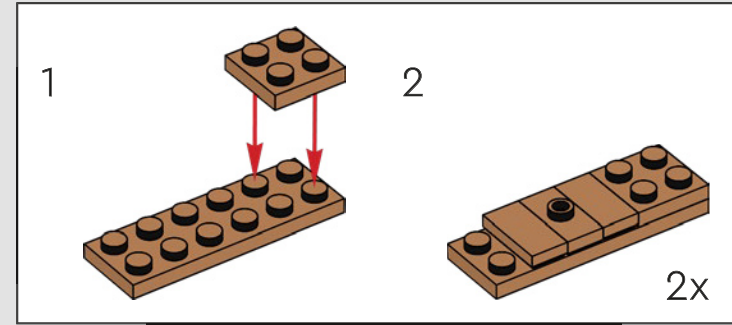
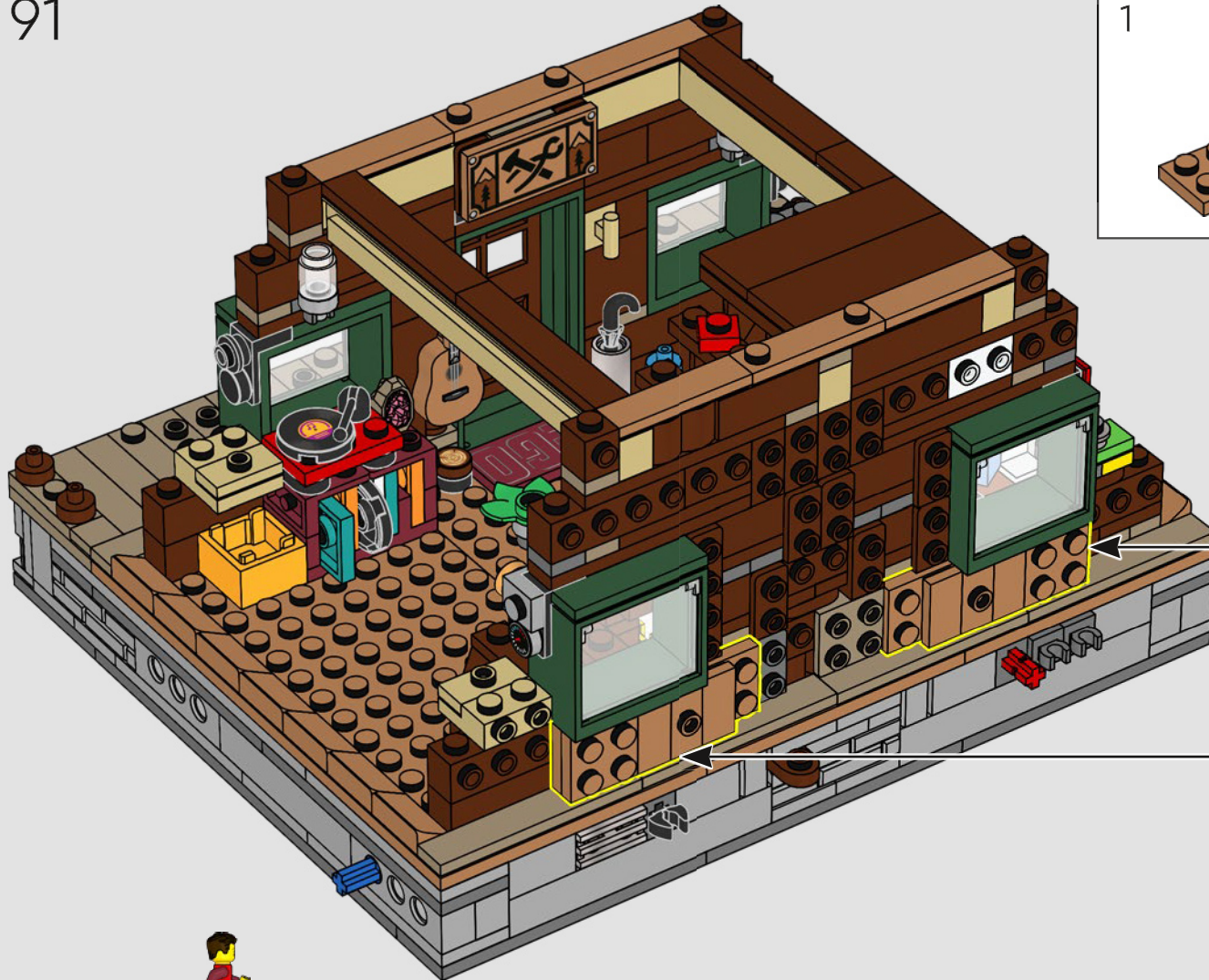



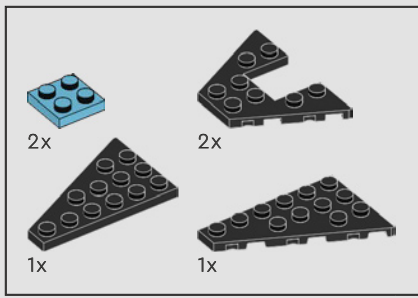

92

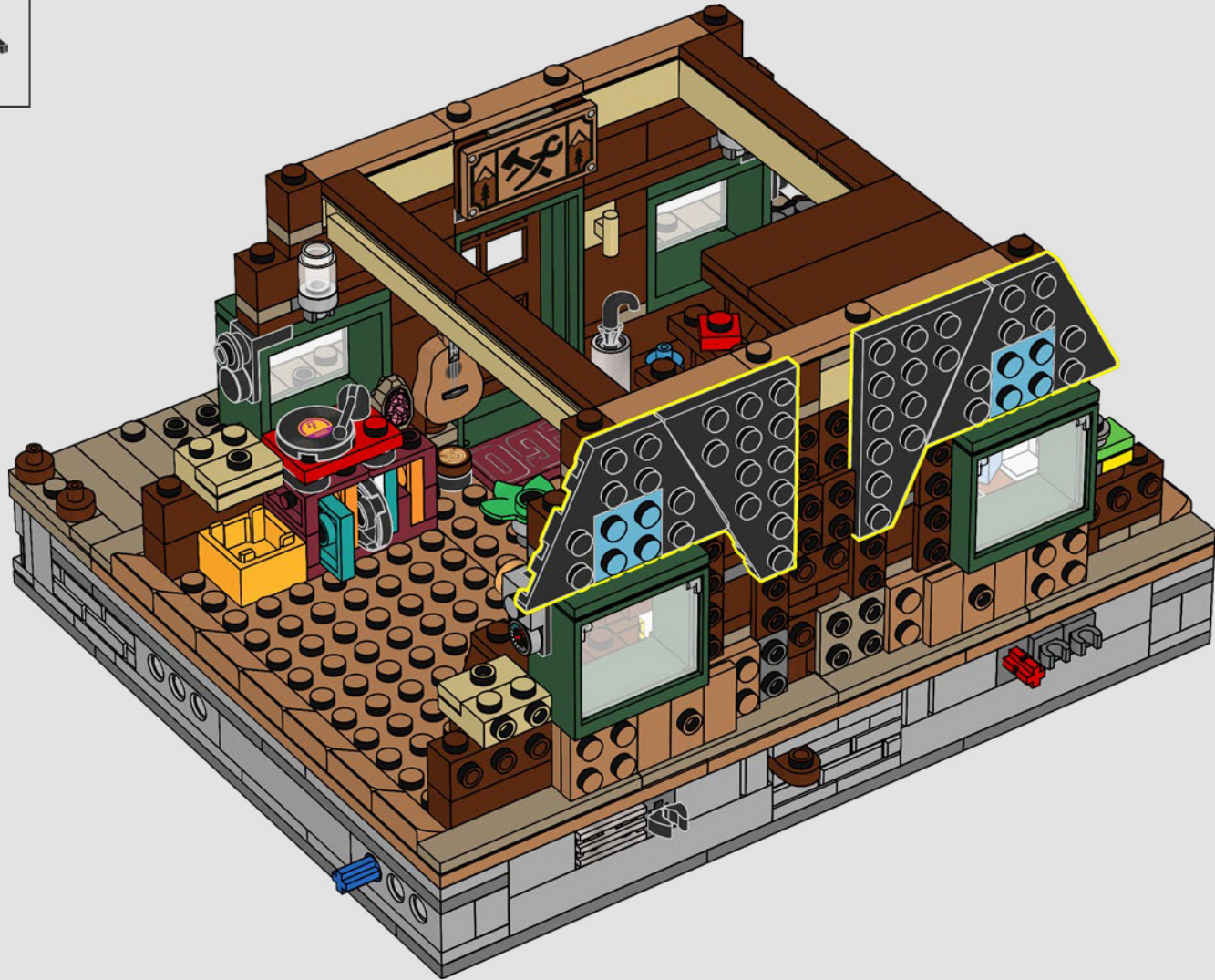

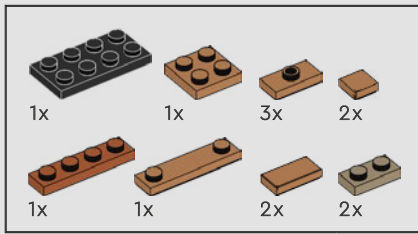

93

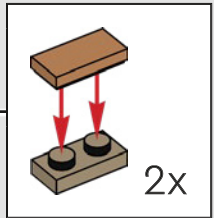
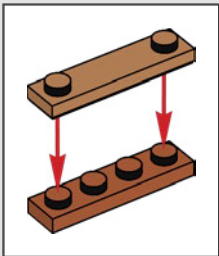
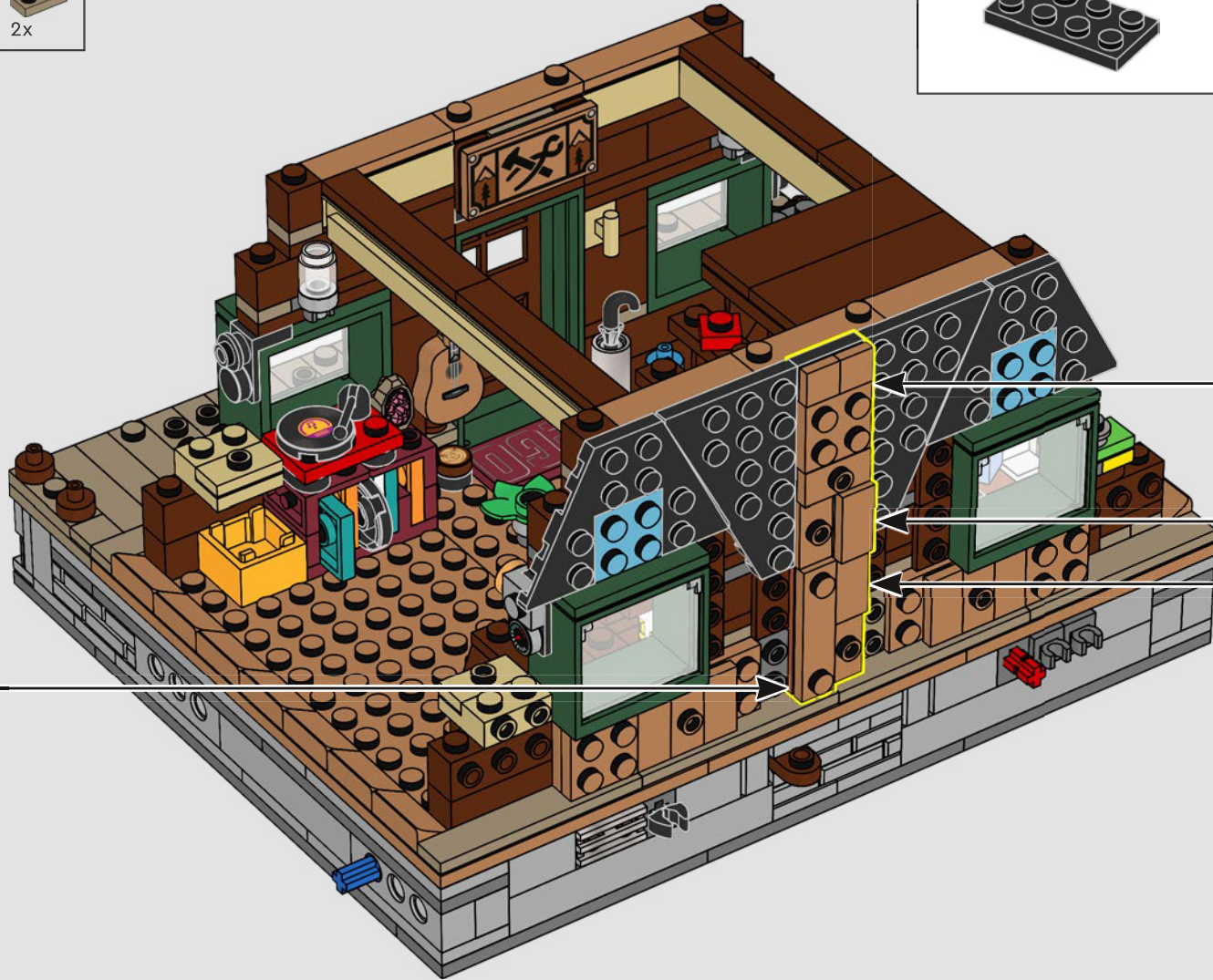
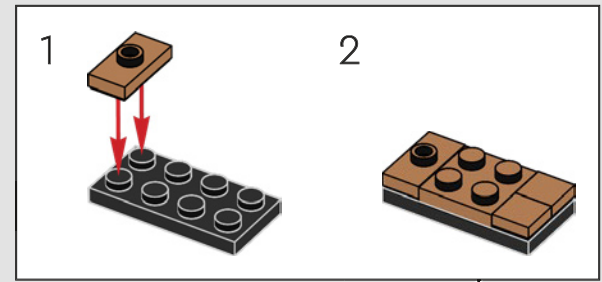



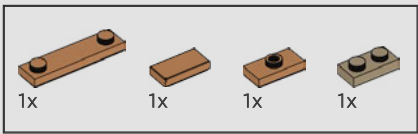

94

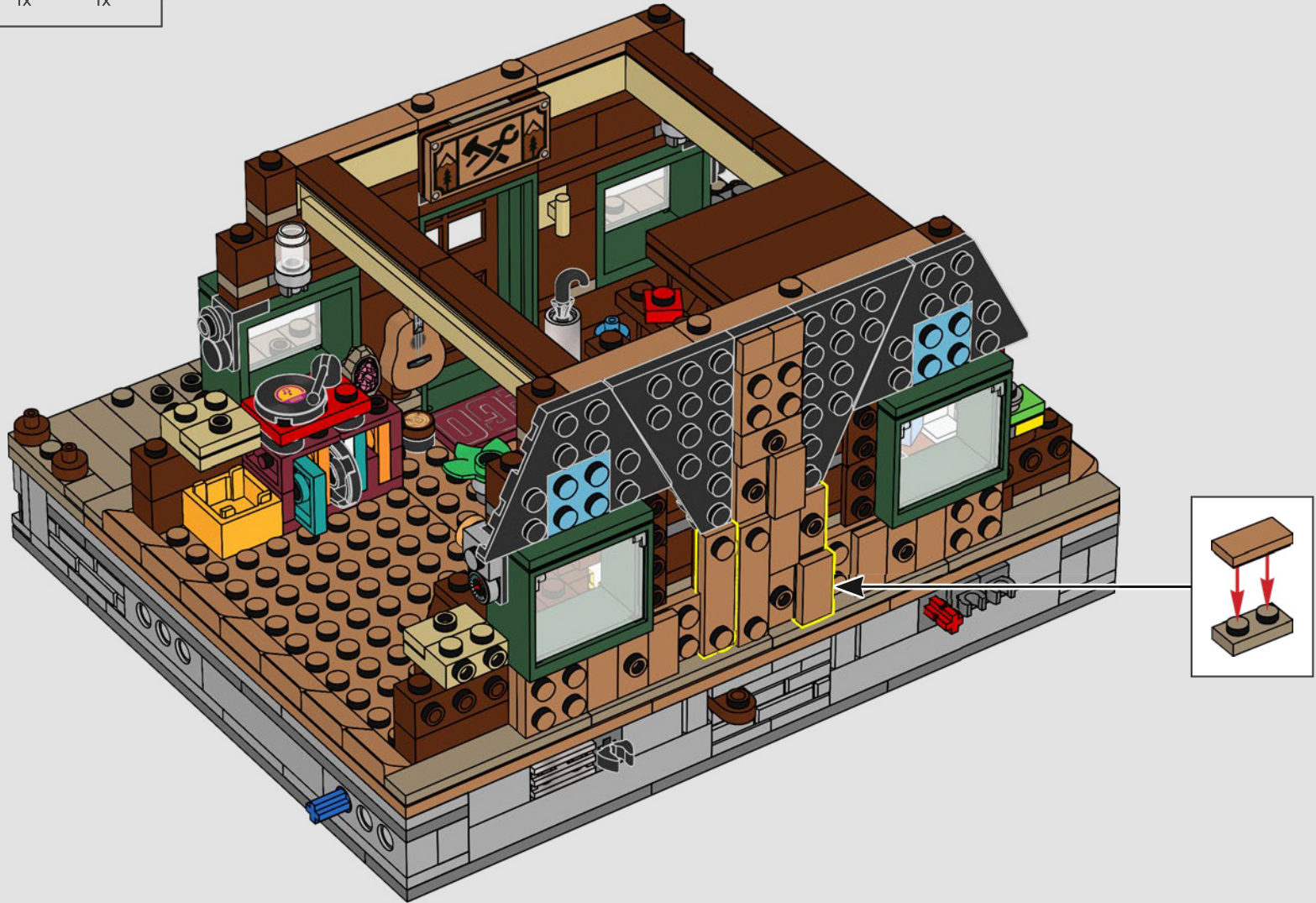

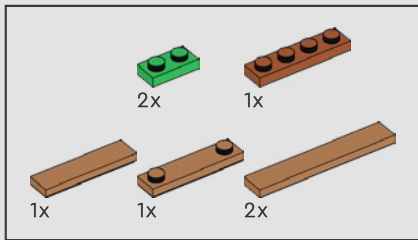

95

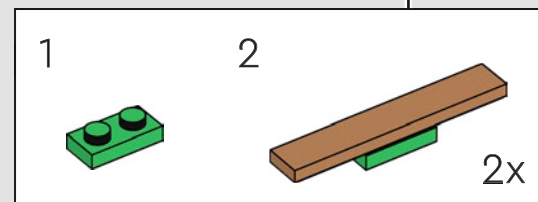
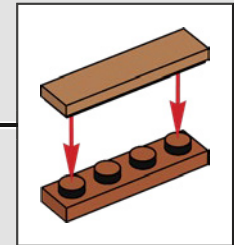
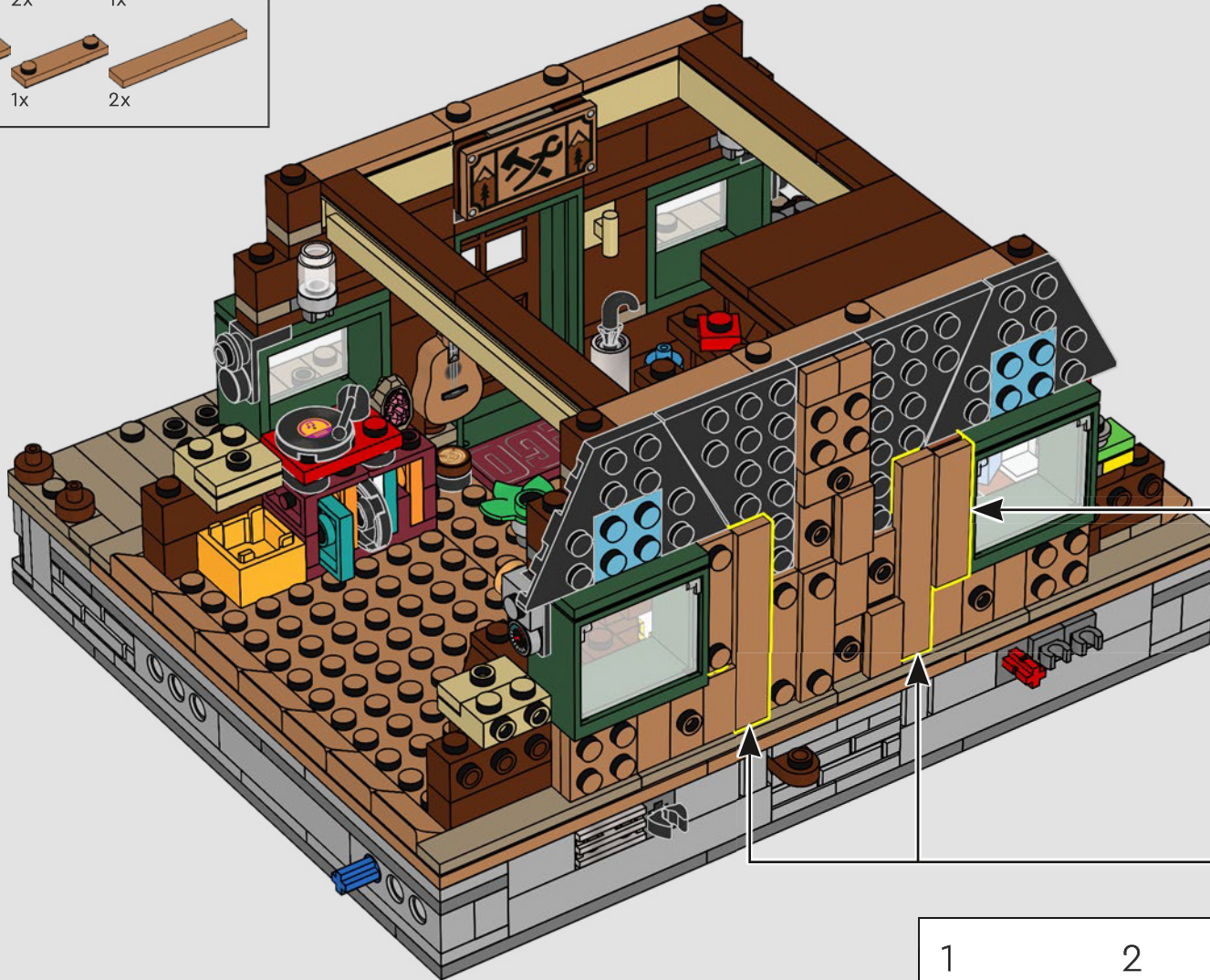



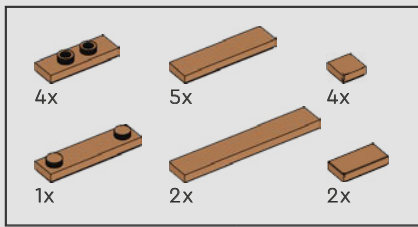

96

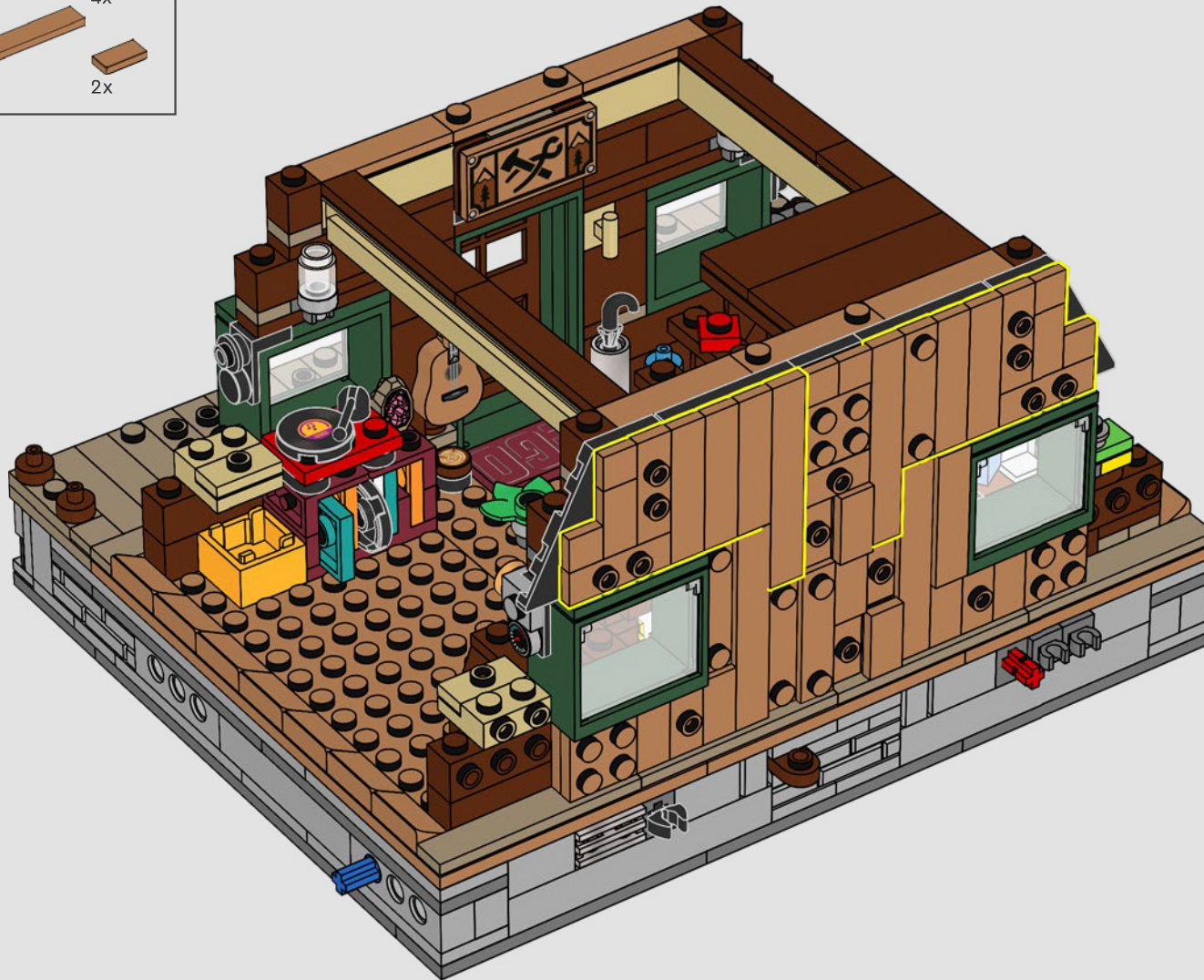

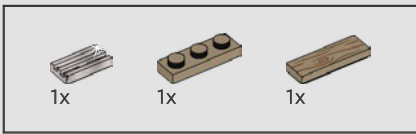

97

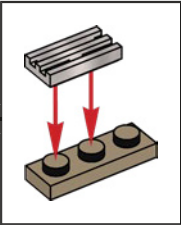
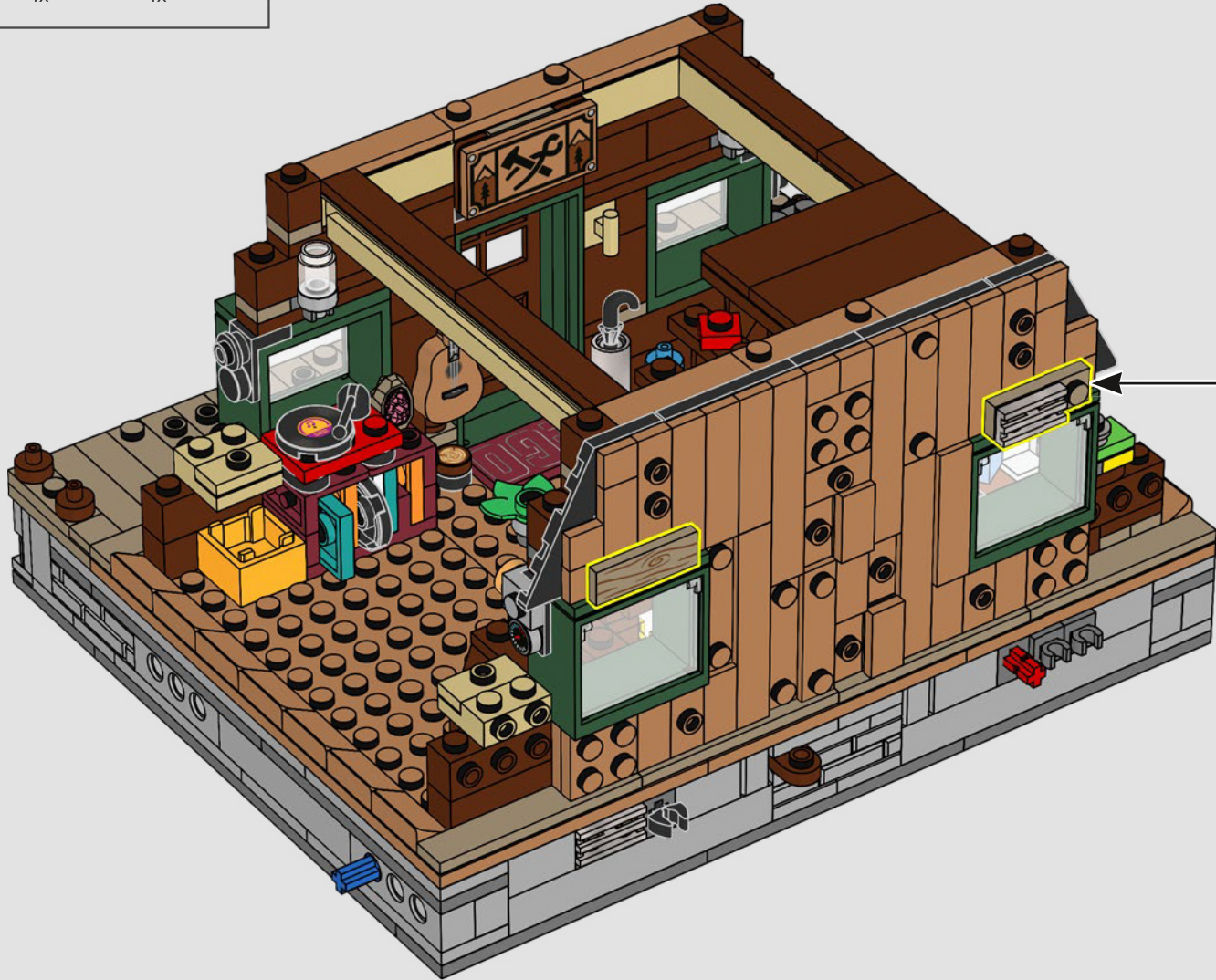



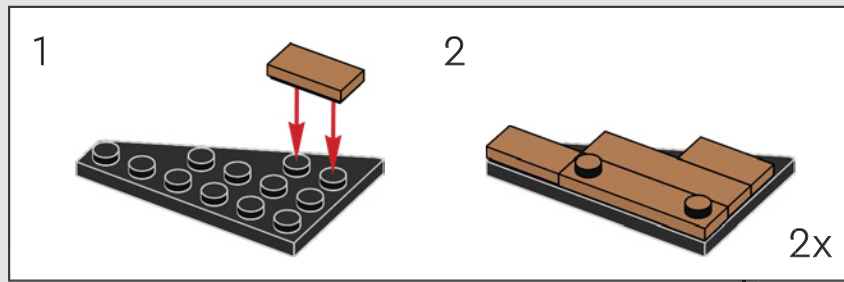
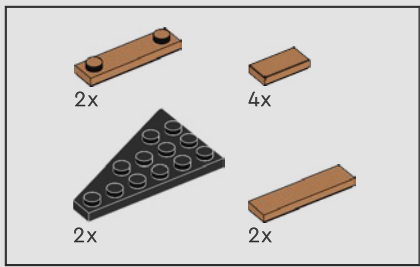

98

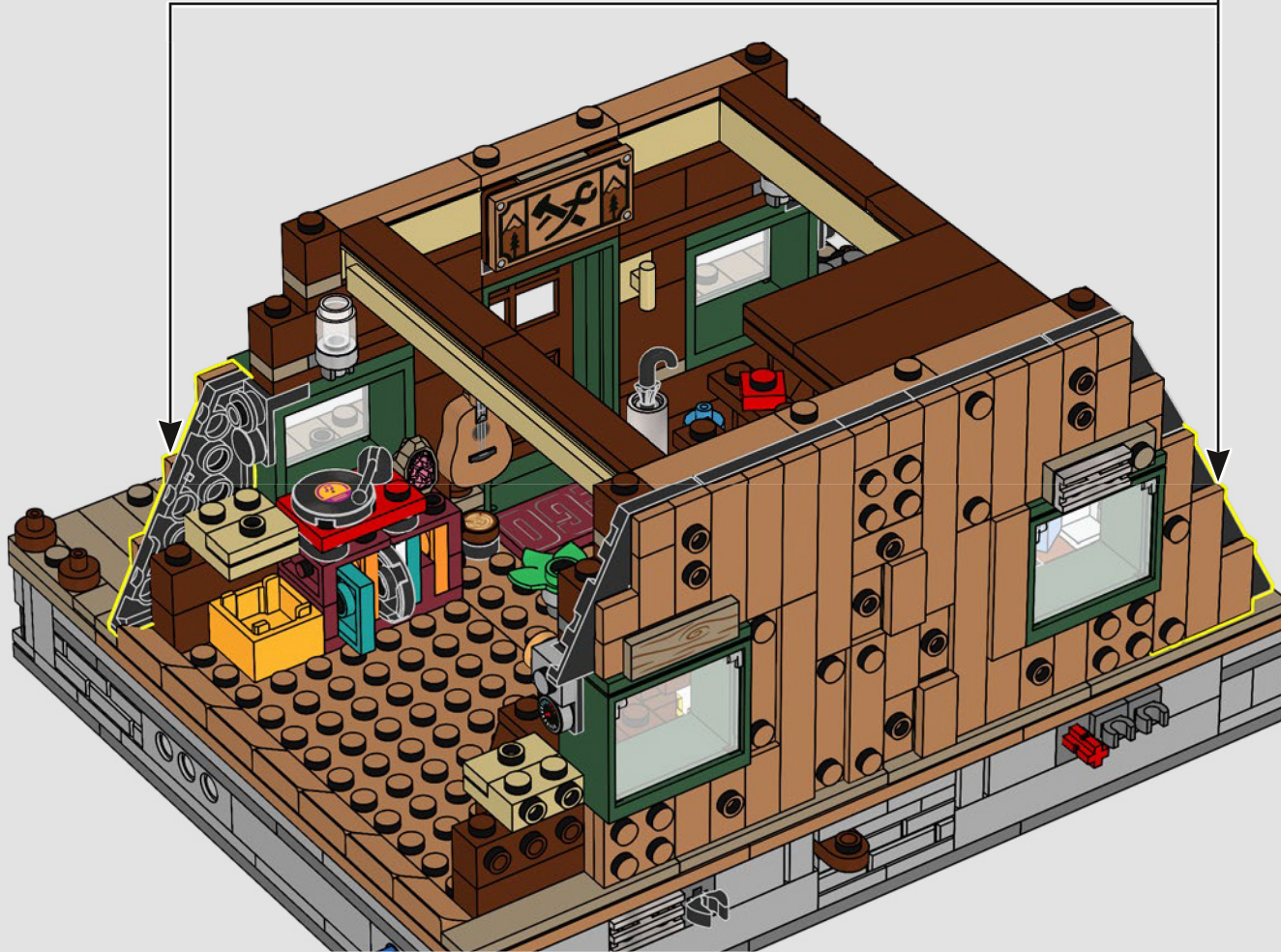

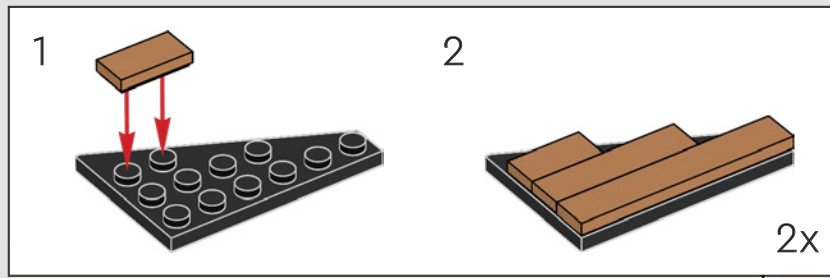
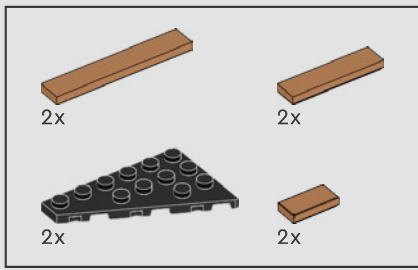

99

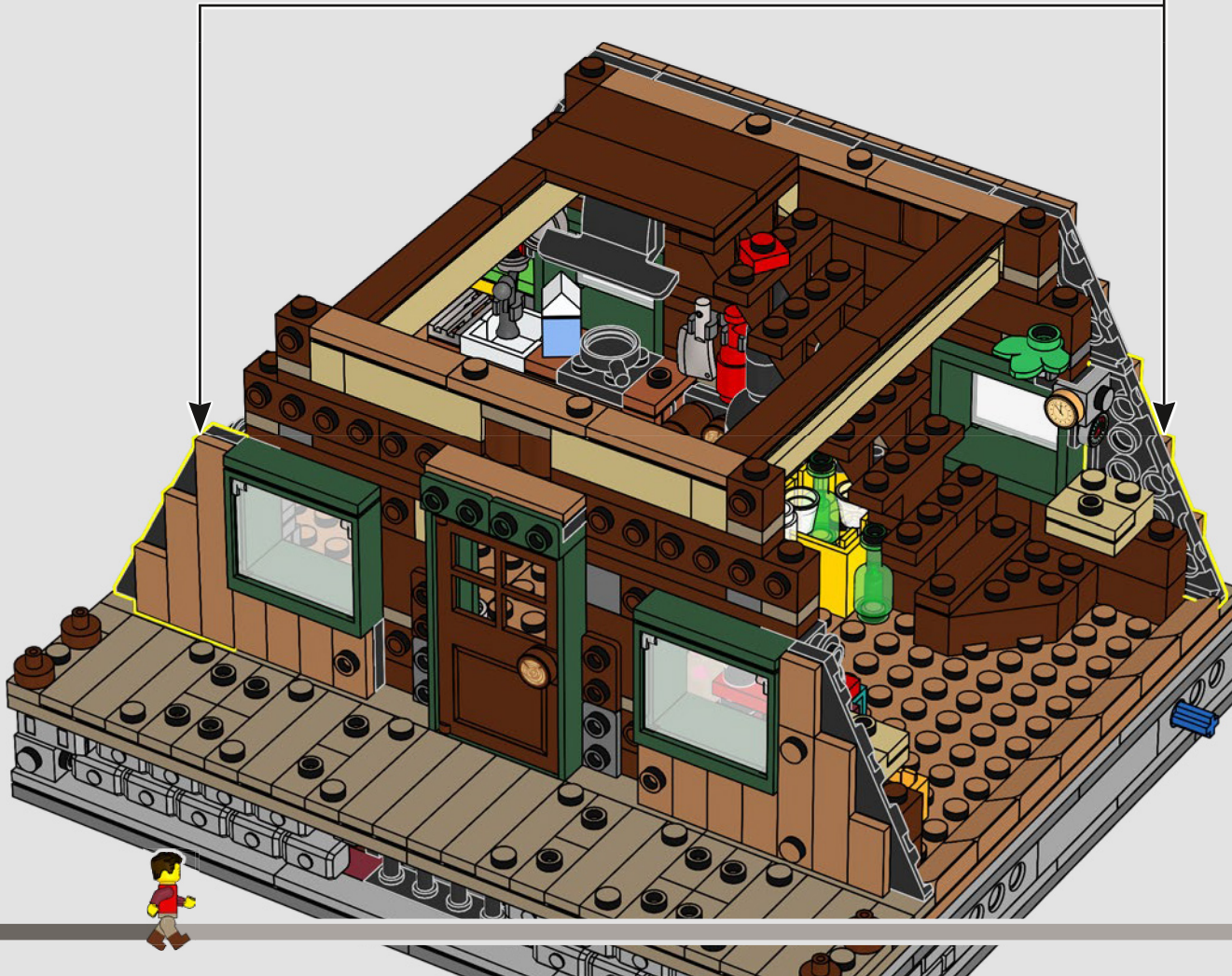



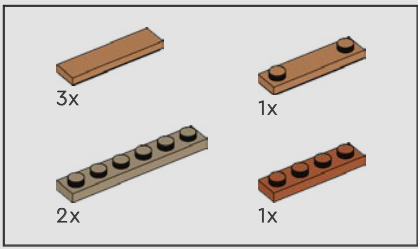

100

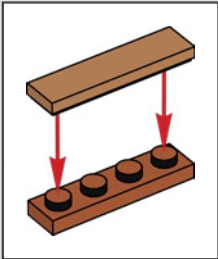
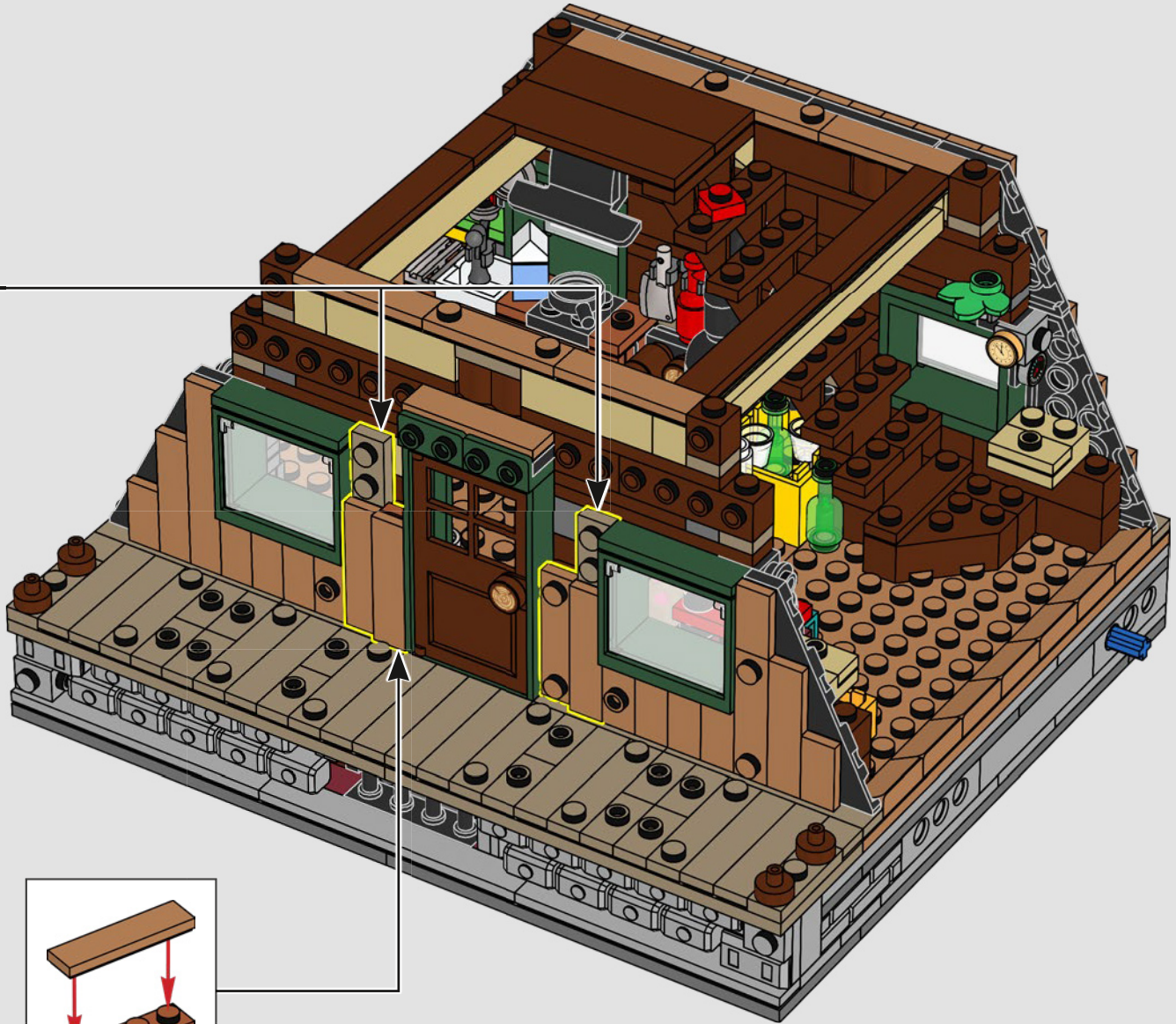
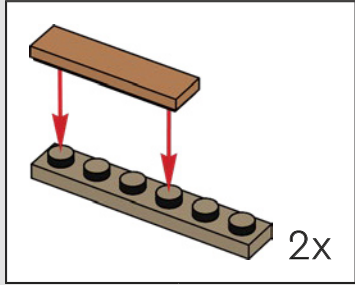

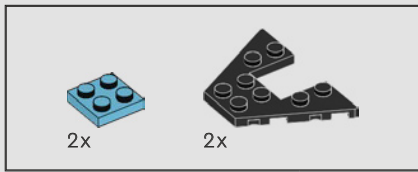

101

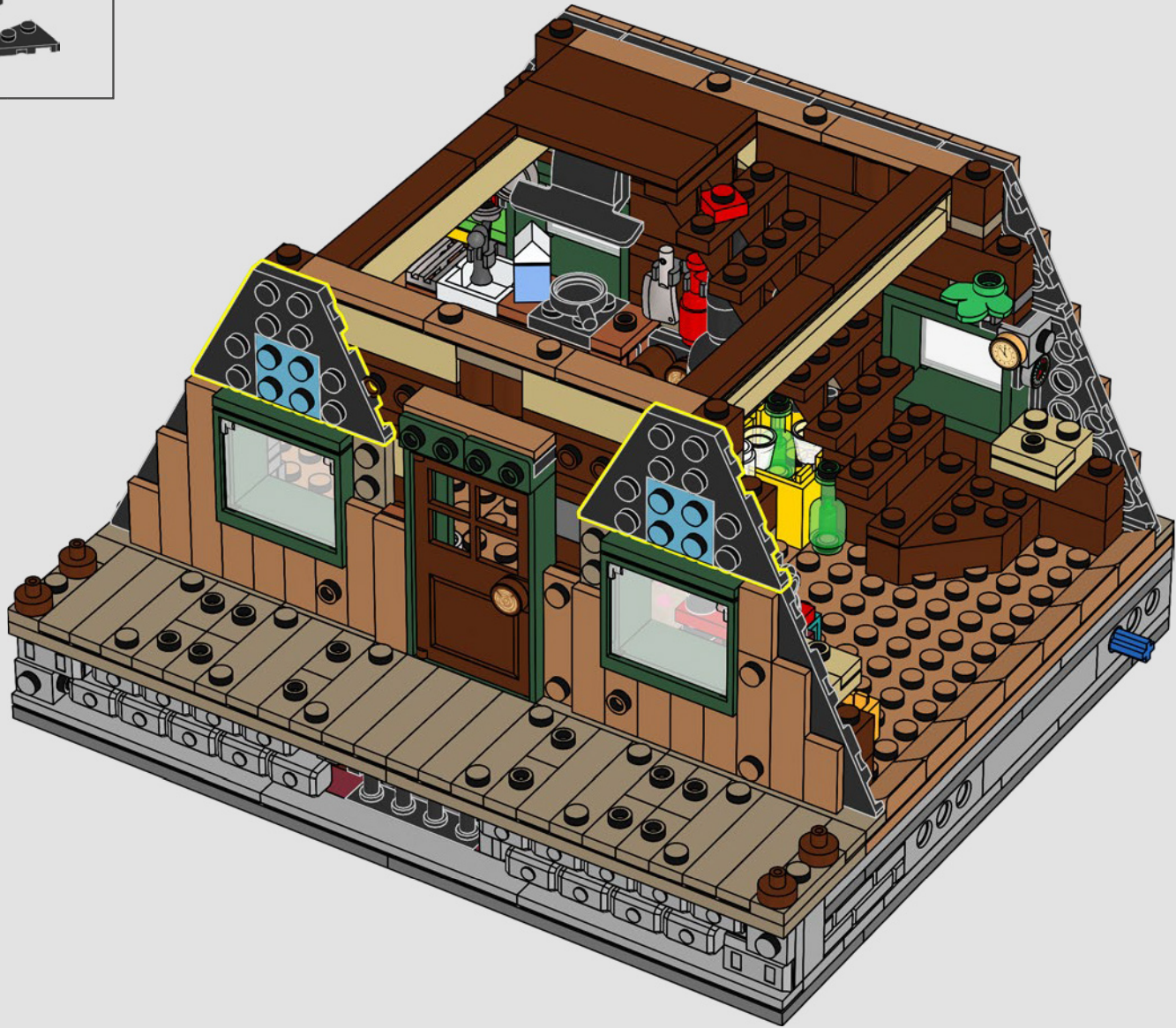



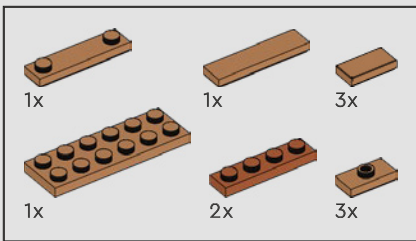

102

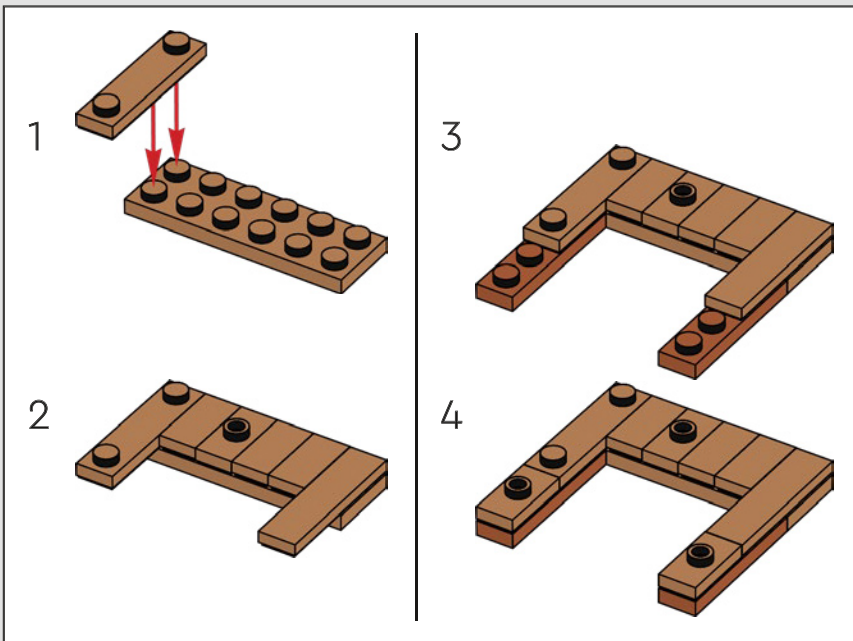

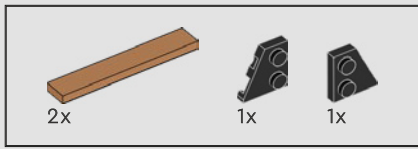

103

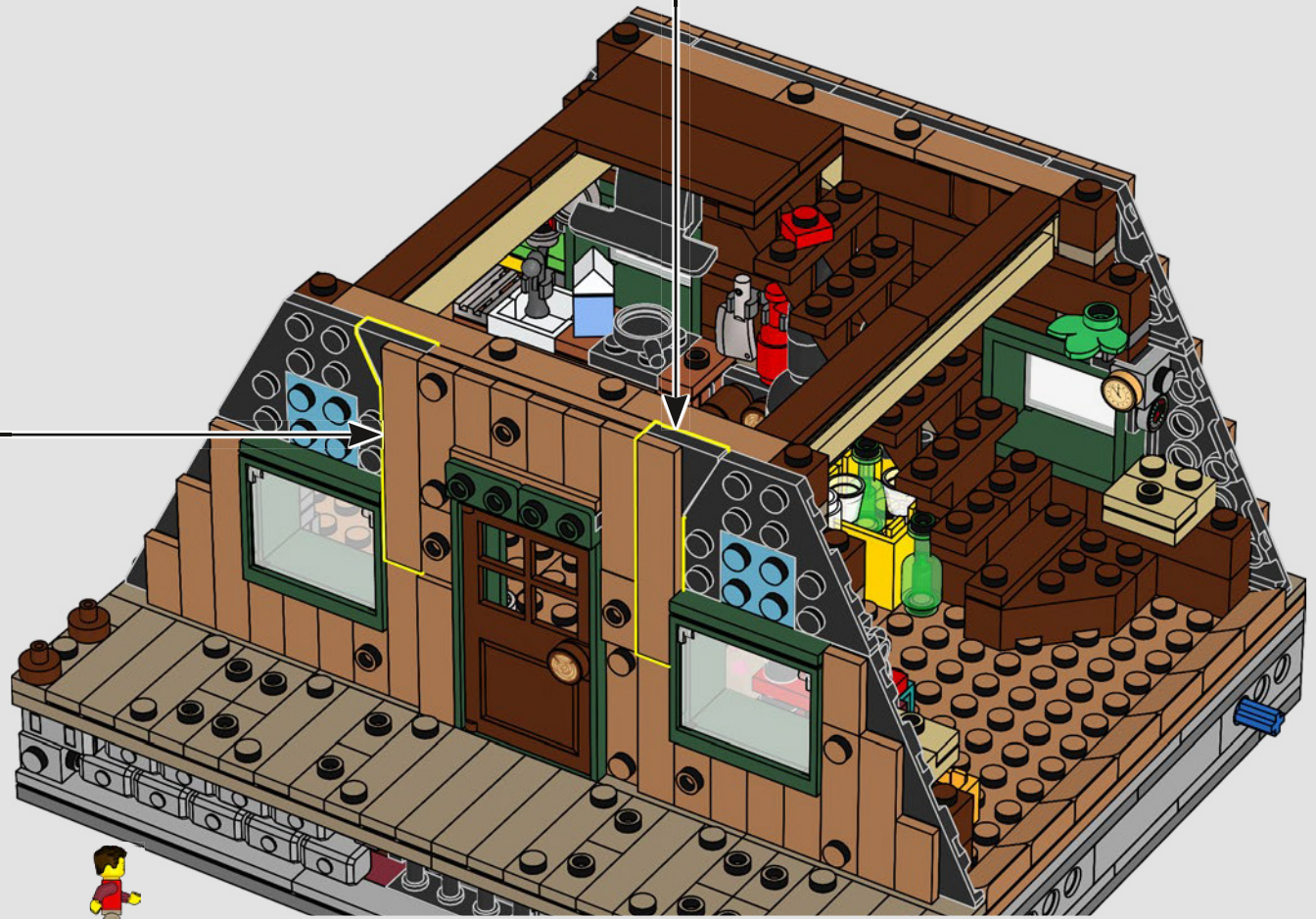
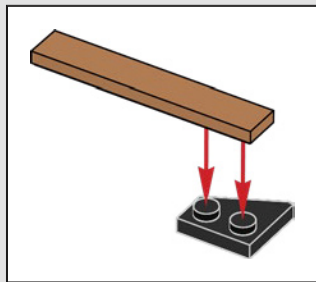
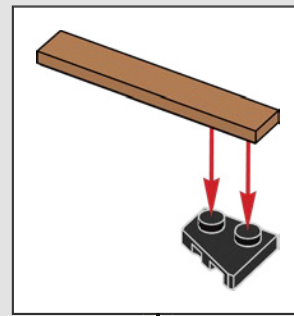



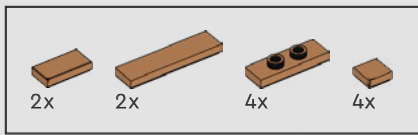

104

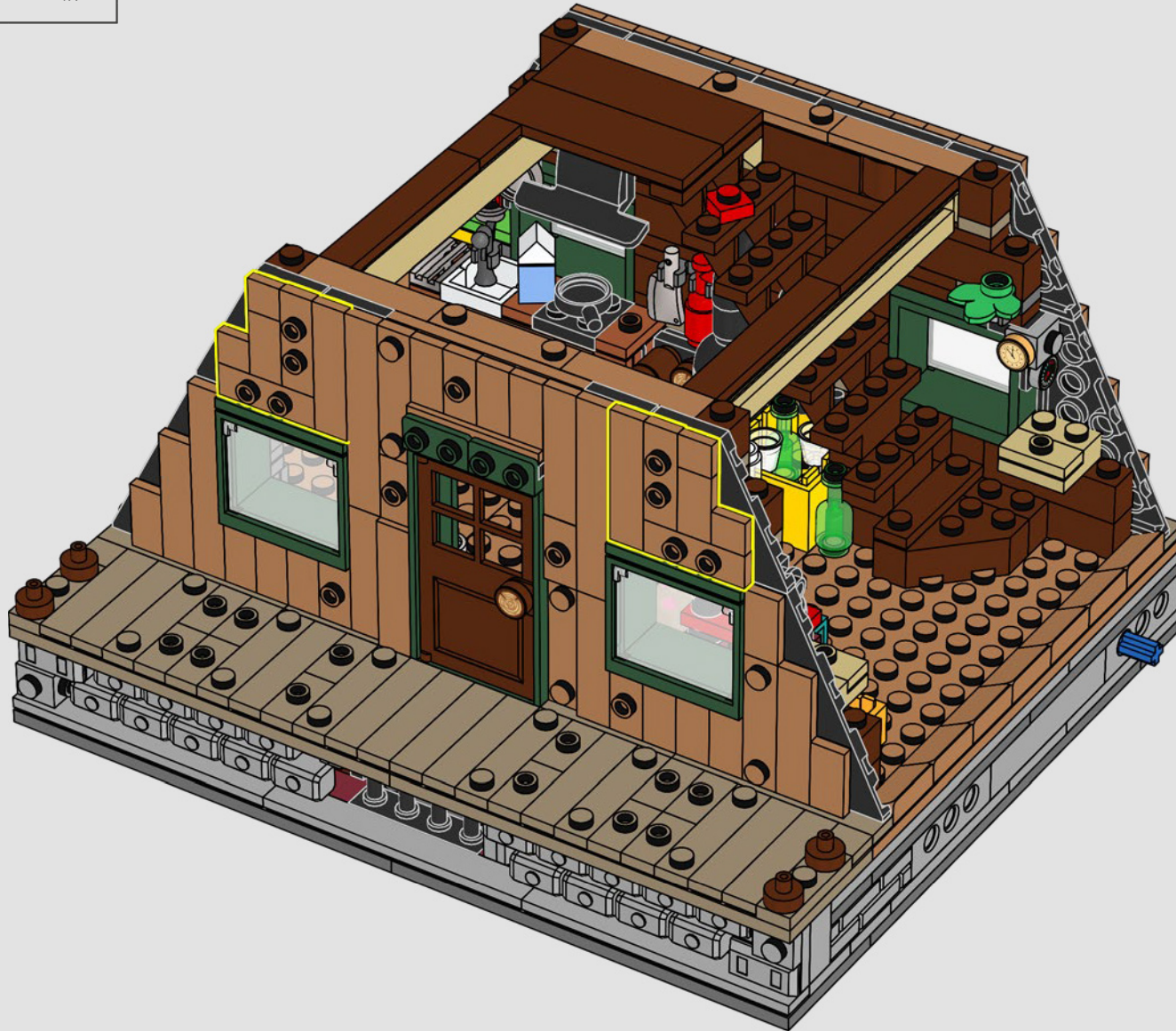

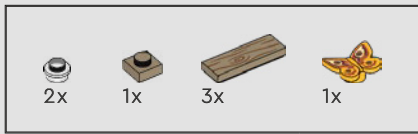

105





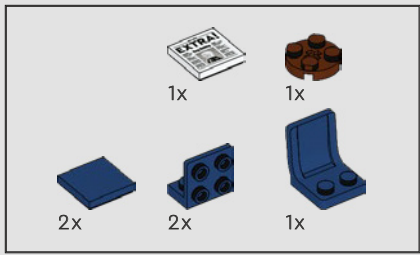

106

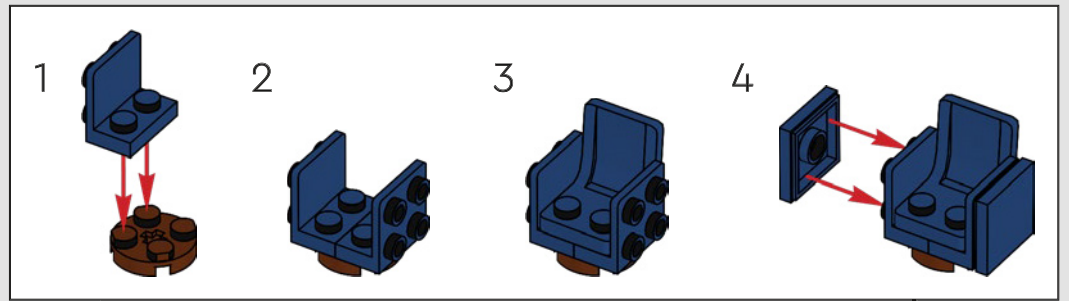

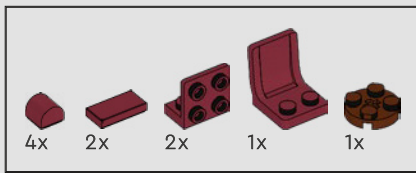

107

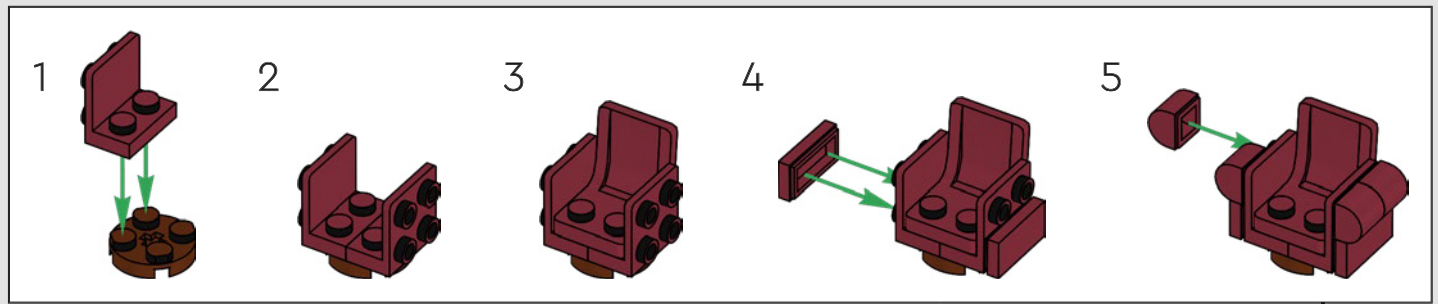



-   
2x
-   
1x
-   
1x
-   
1x

108



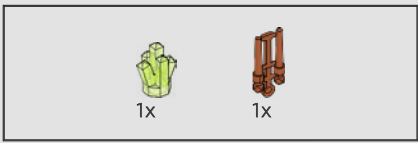

109

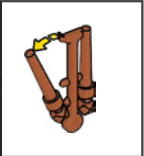



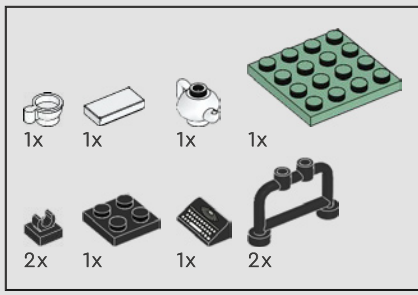

110

1

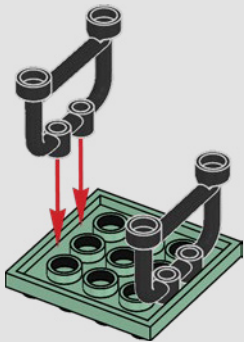

2

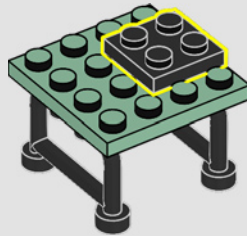

3

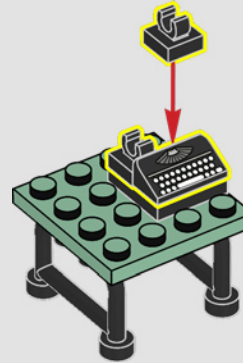

4



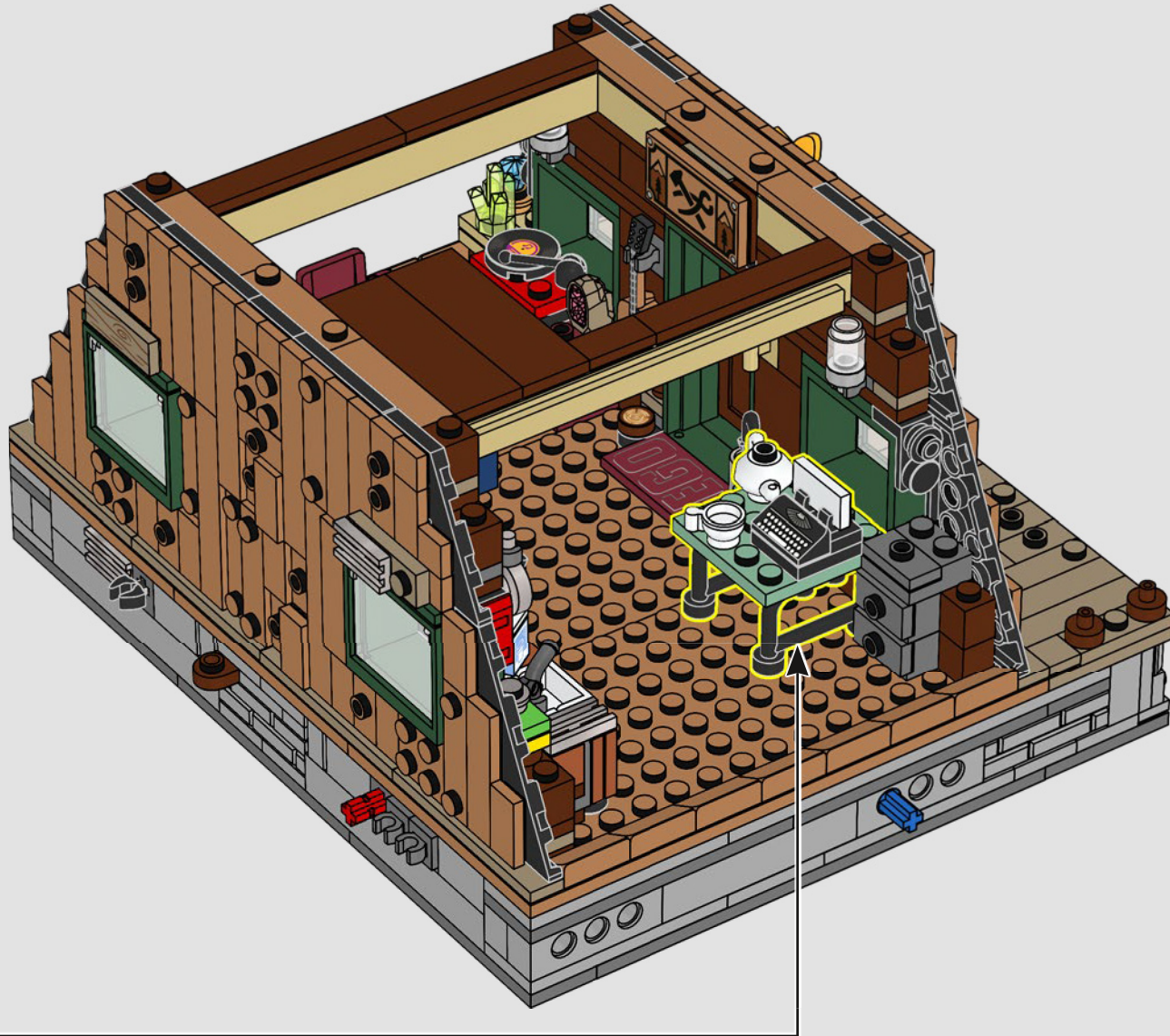



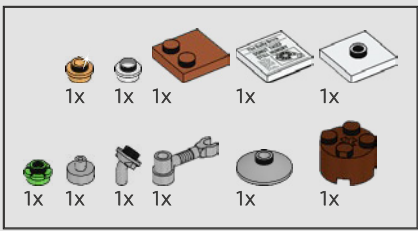

111

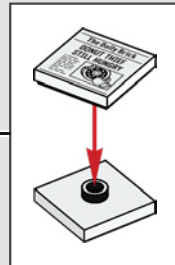
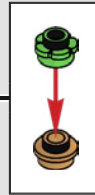
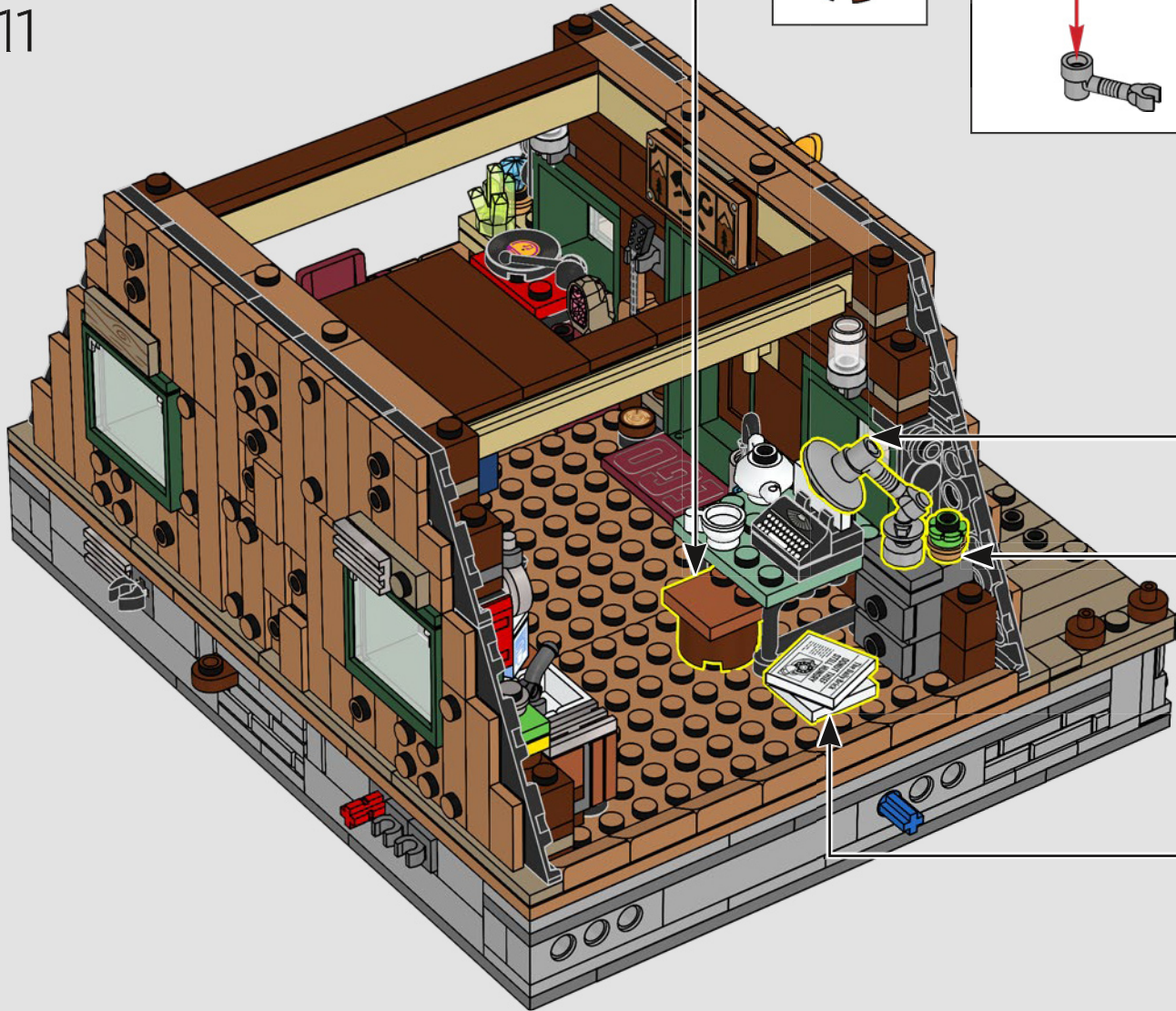
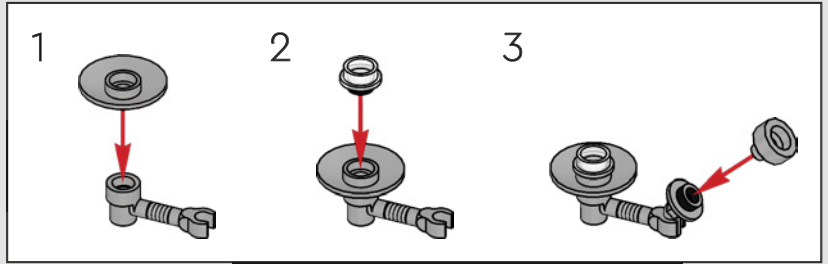
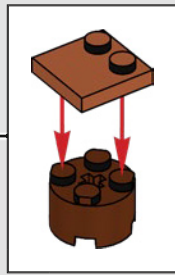

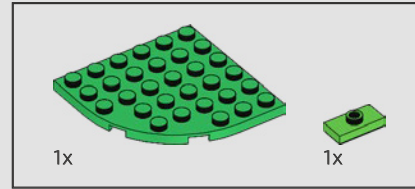
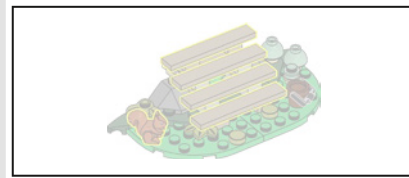

112

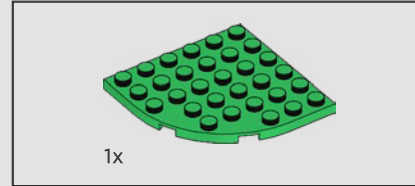
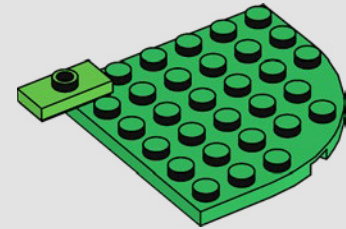

113

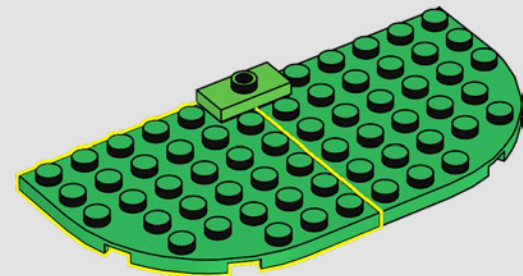



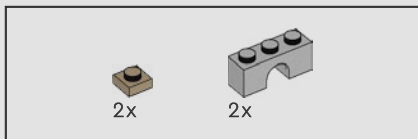

114

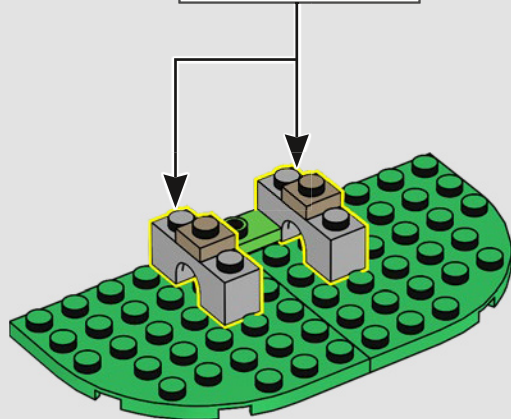
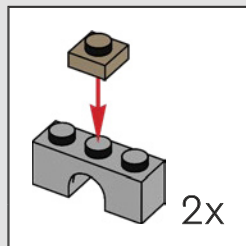

115

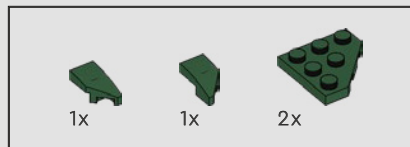
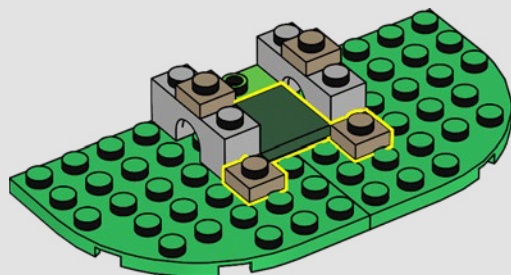

116

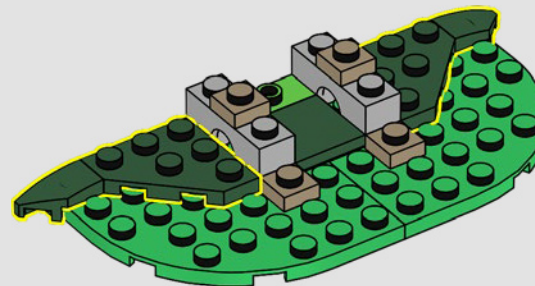

117

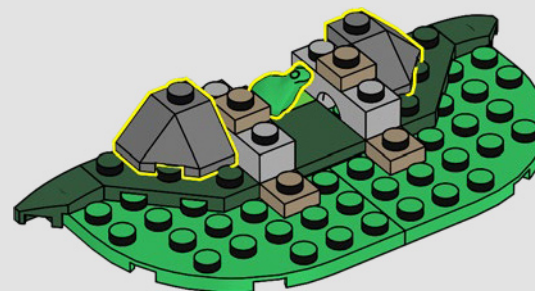

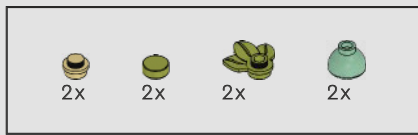

118

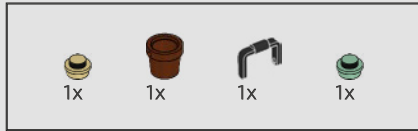
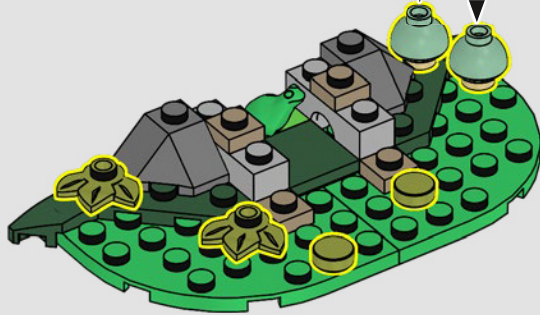
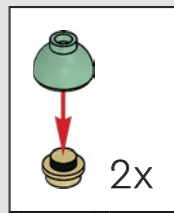

119

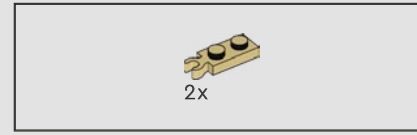
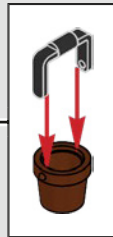
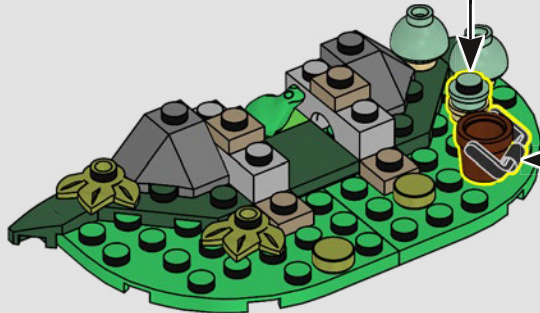
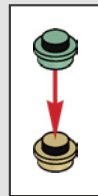

120

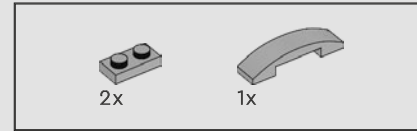
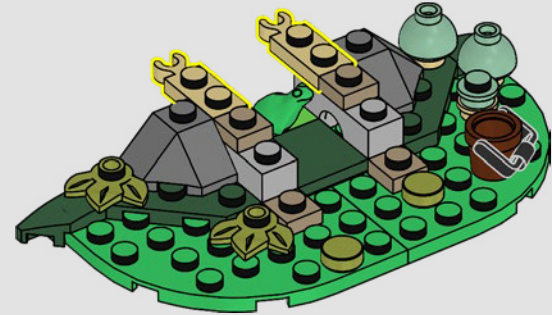

121

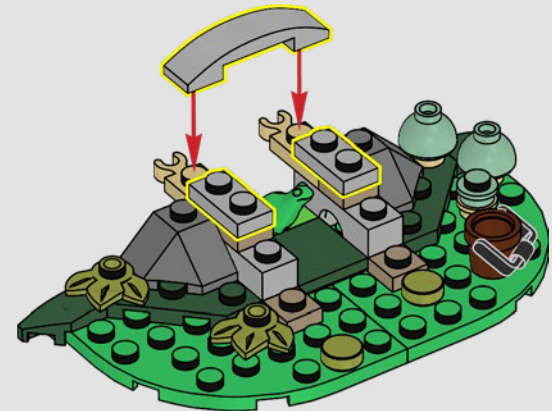



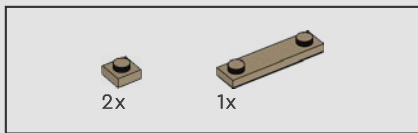

122

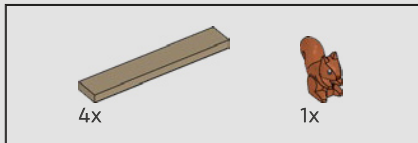
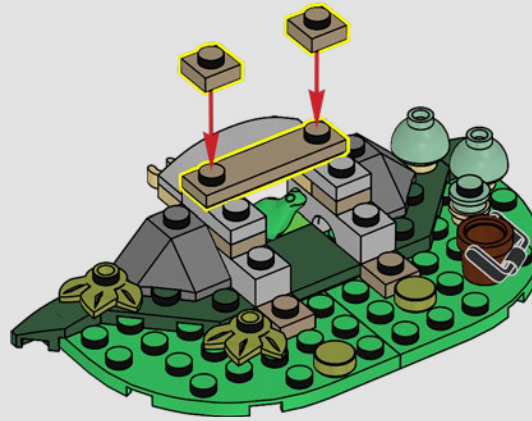

123

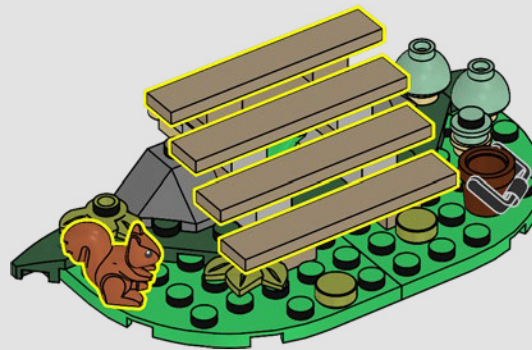

124

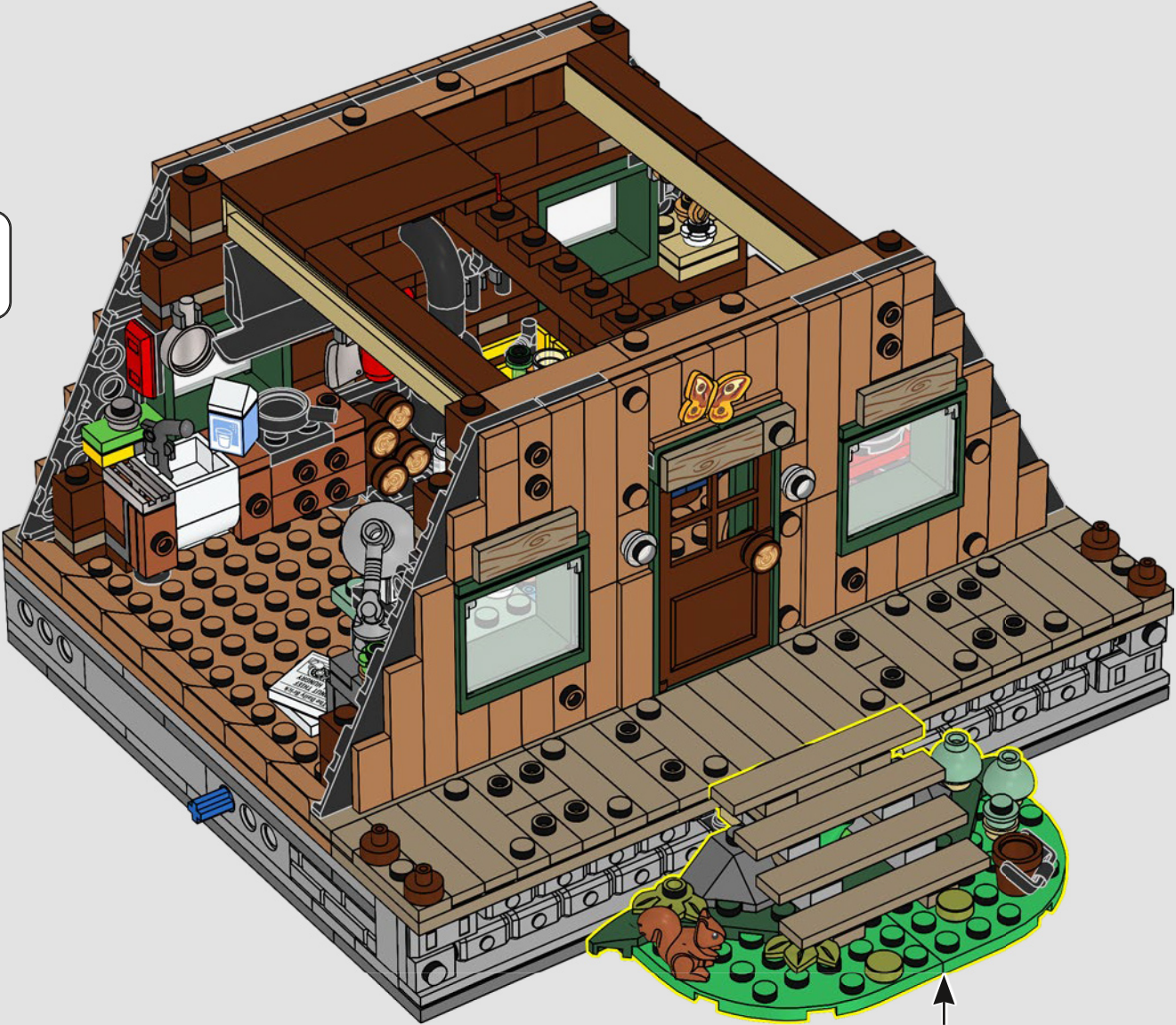



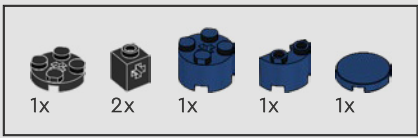

125

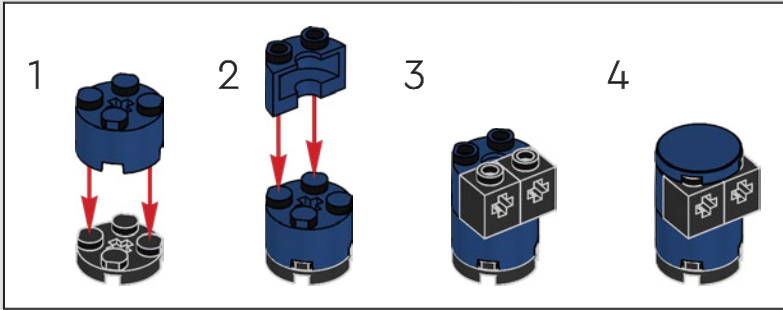

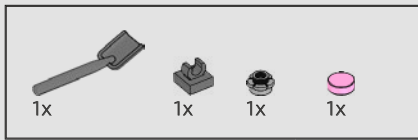

126





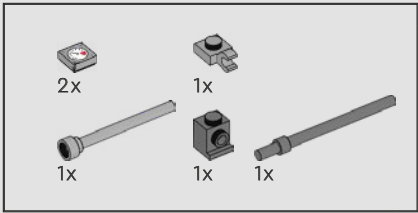

127

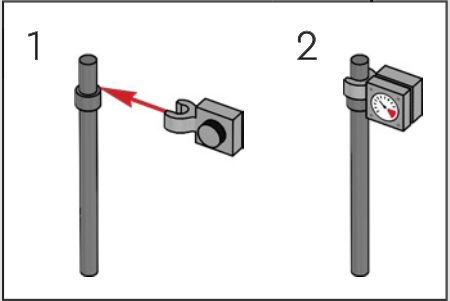
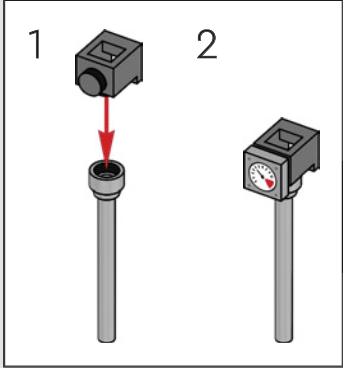

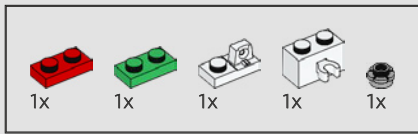

128

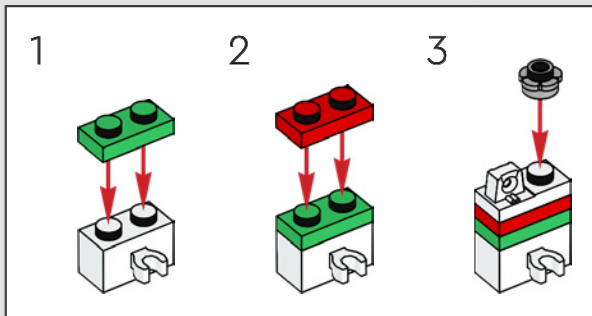



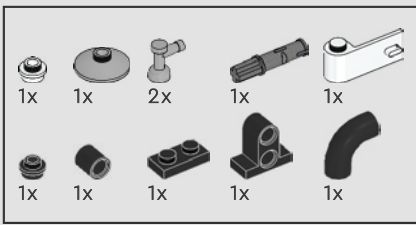

129

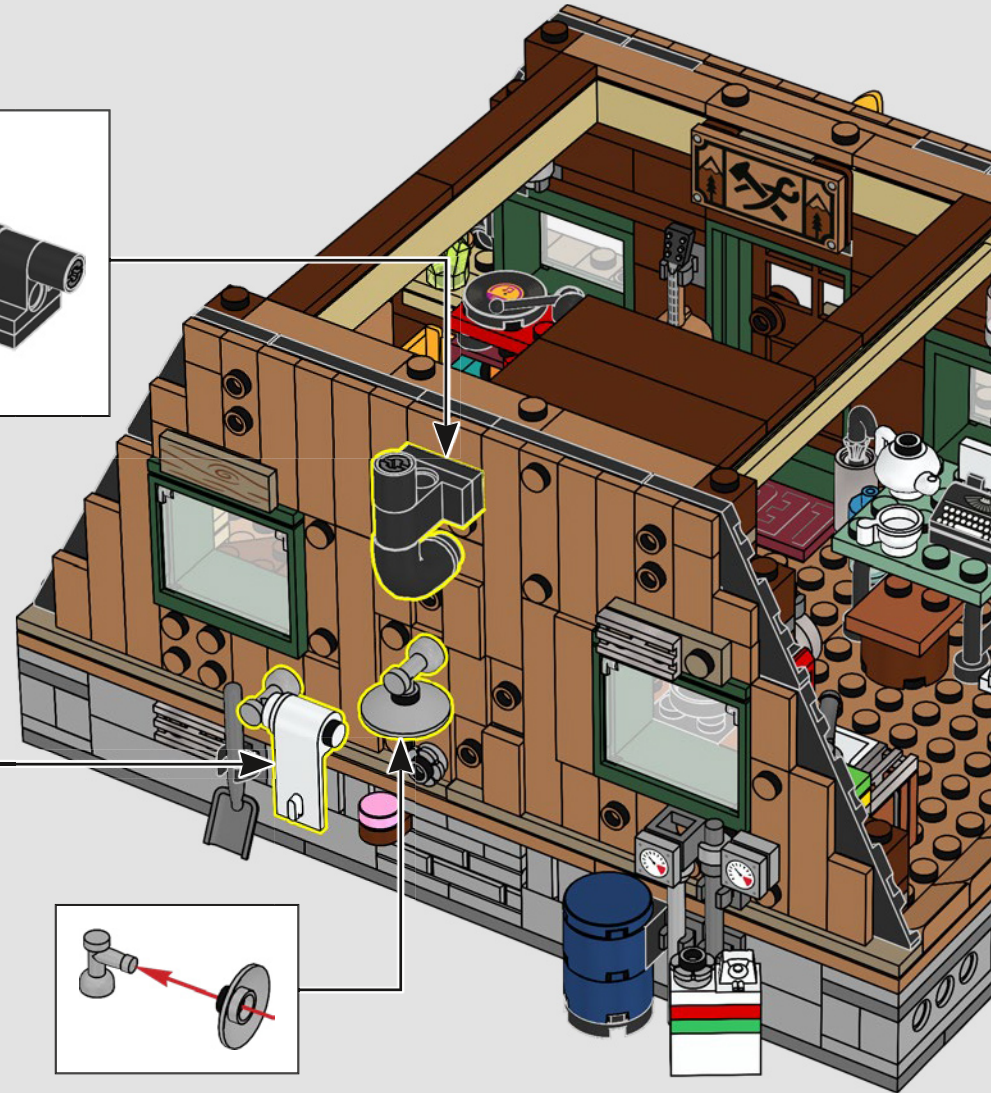
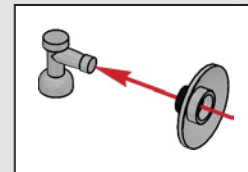
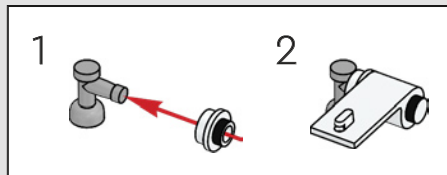
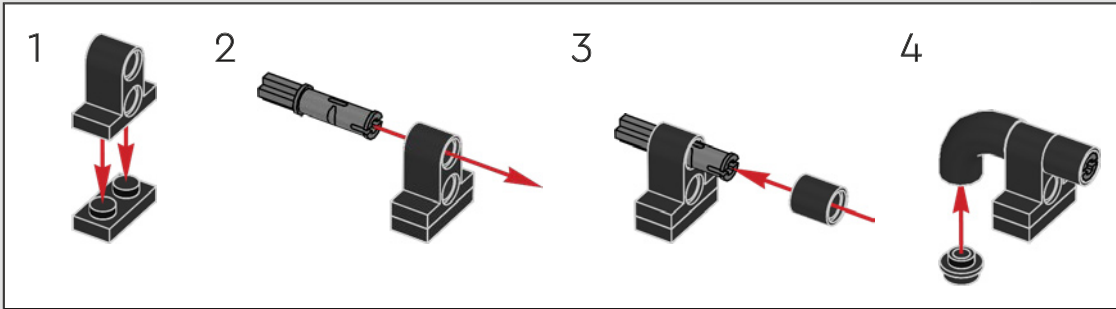

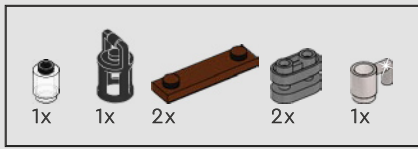

130

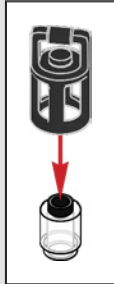
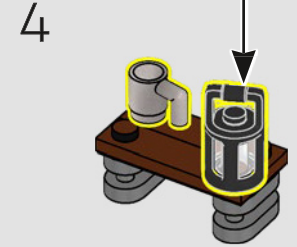
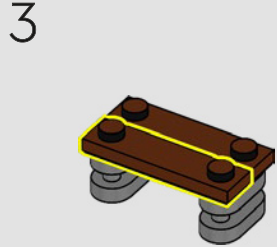
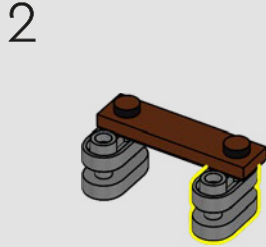
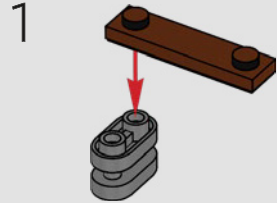





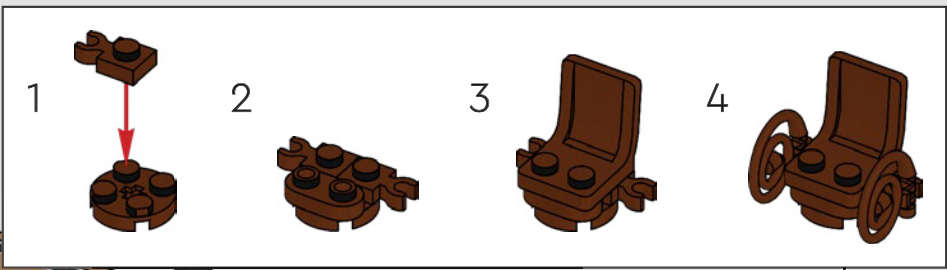
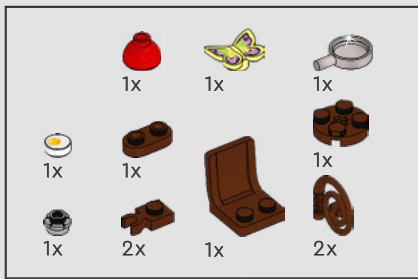

131

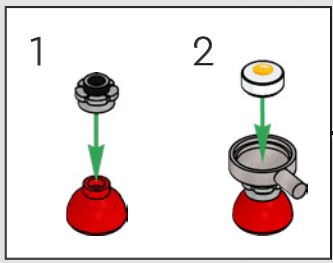



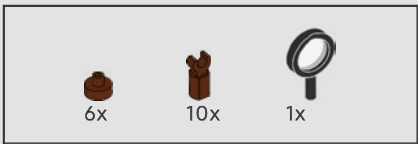

132

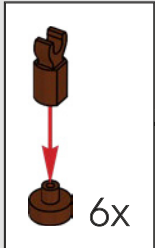



133





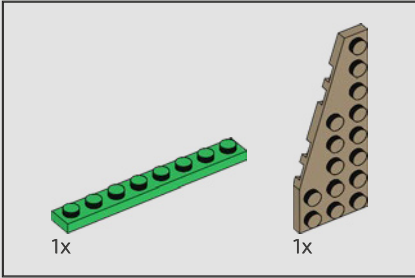

134

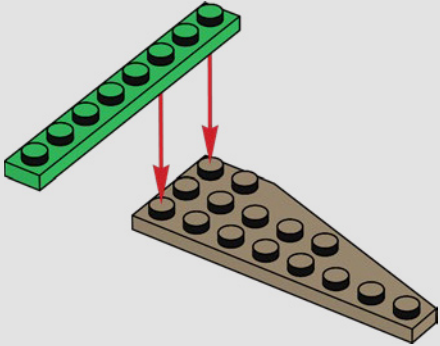

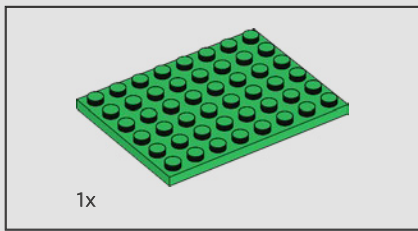

135

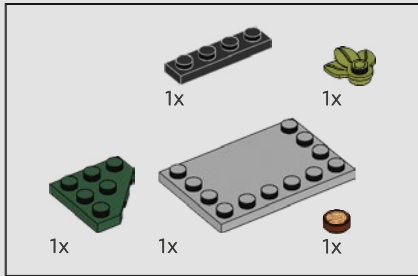
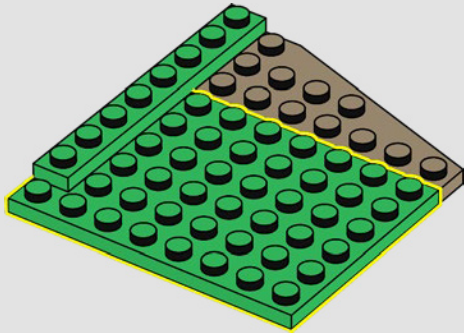

136

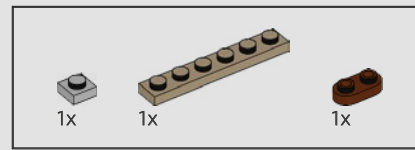
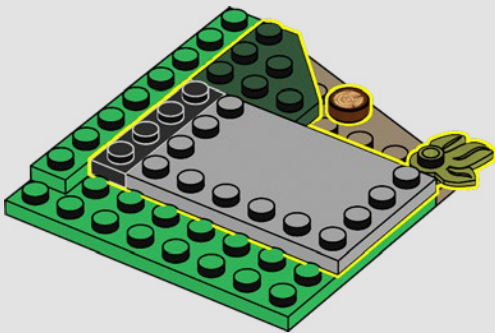

137

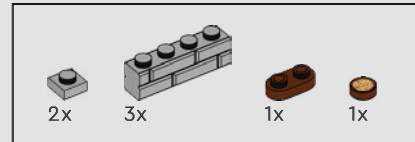
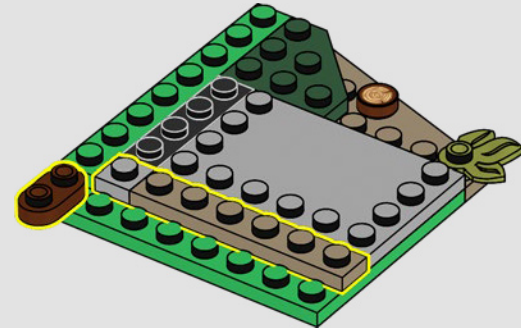

138

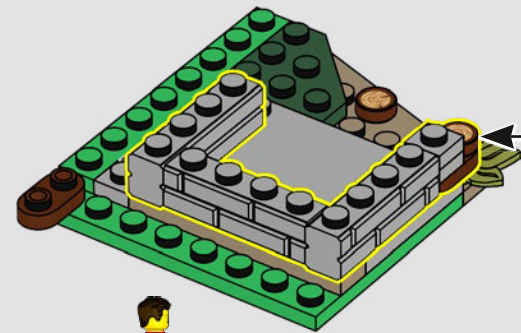
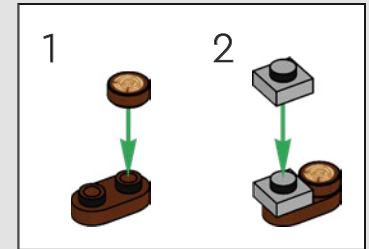



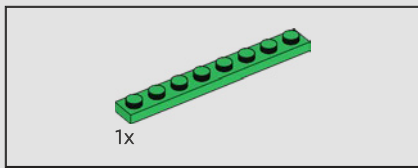

139

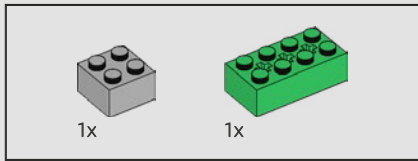
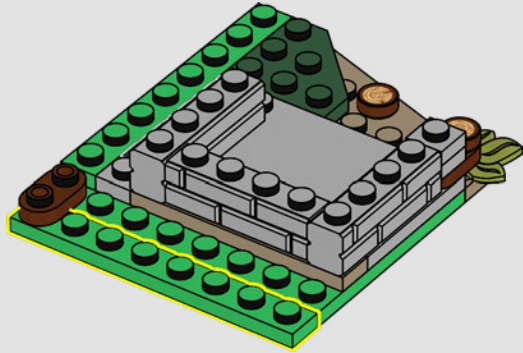

140

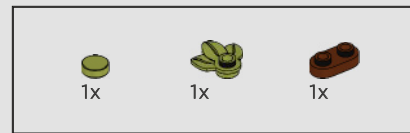
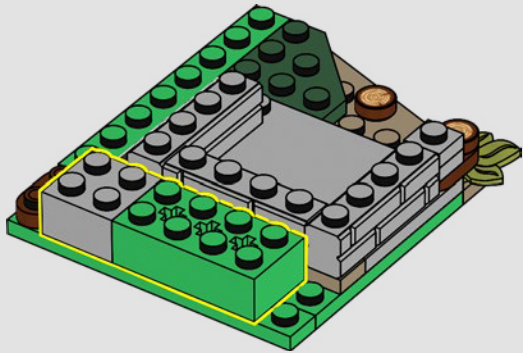

141

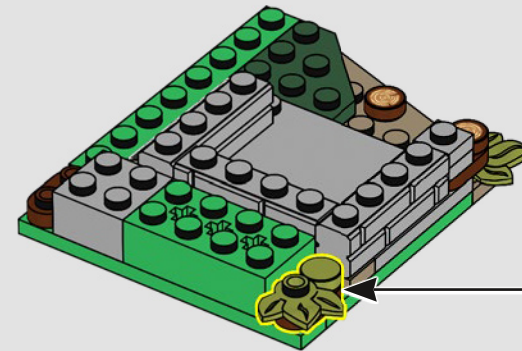
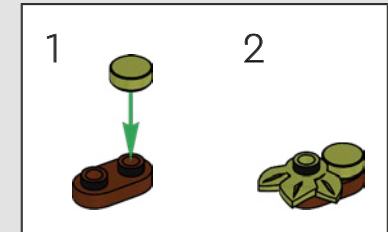

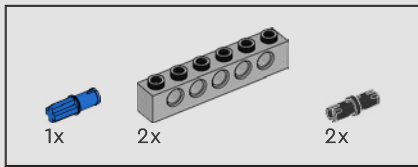

142

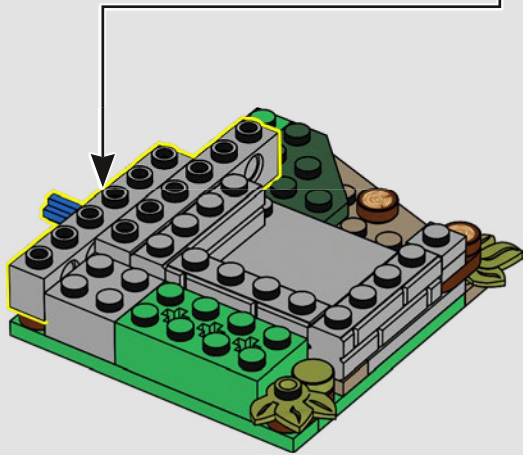
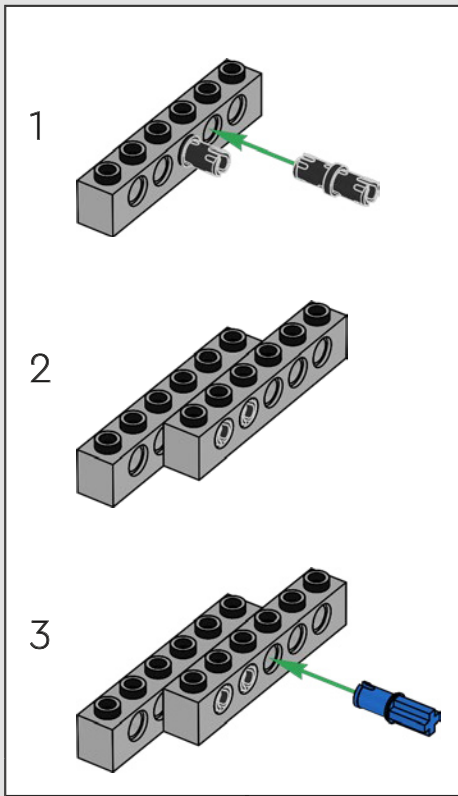

143

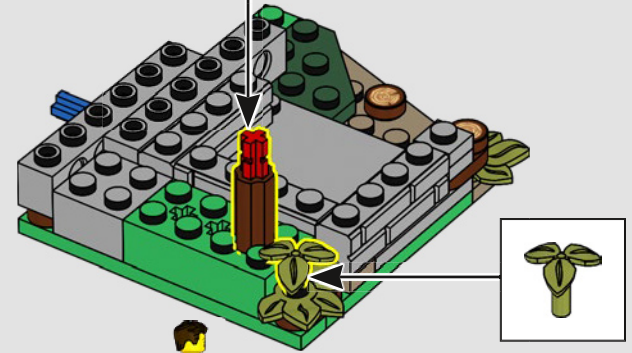
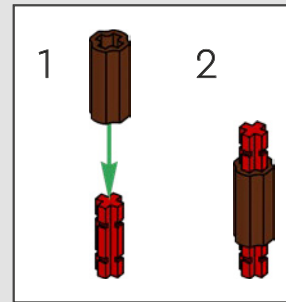



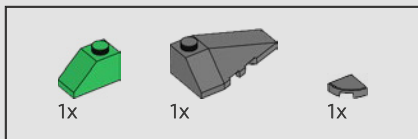

144

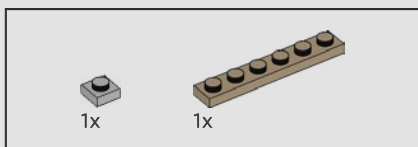
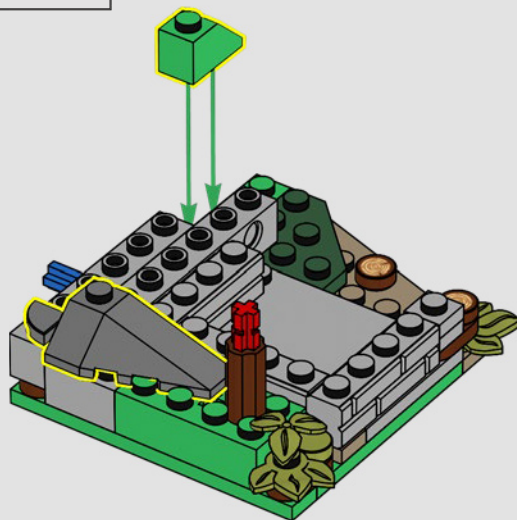

145

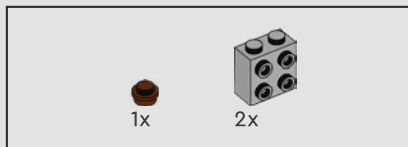
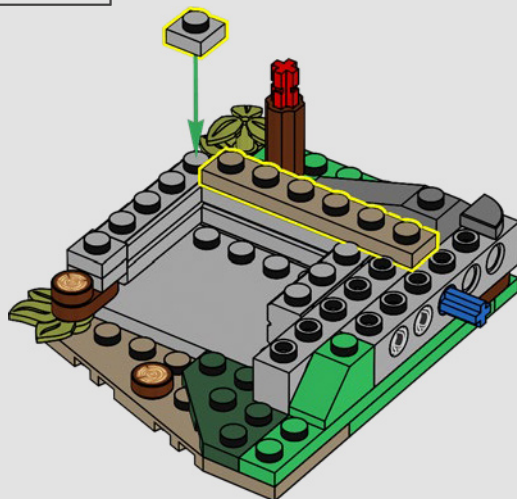

146

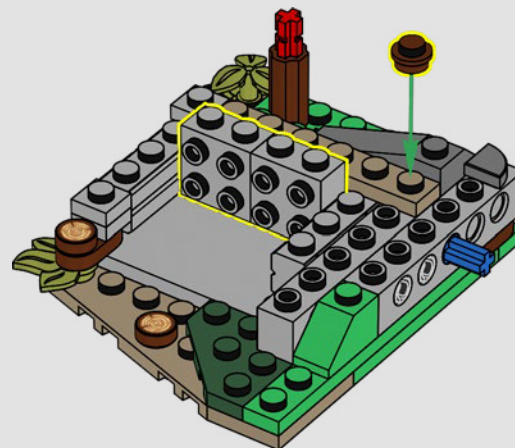



147

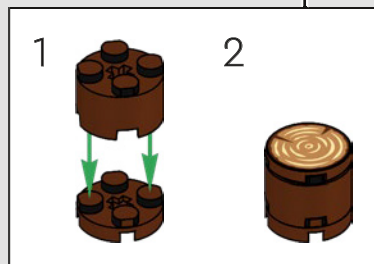
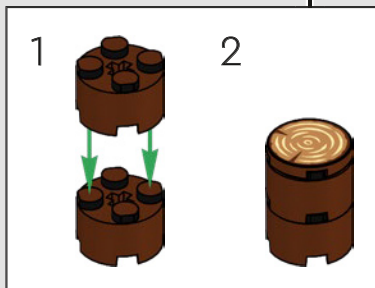
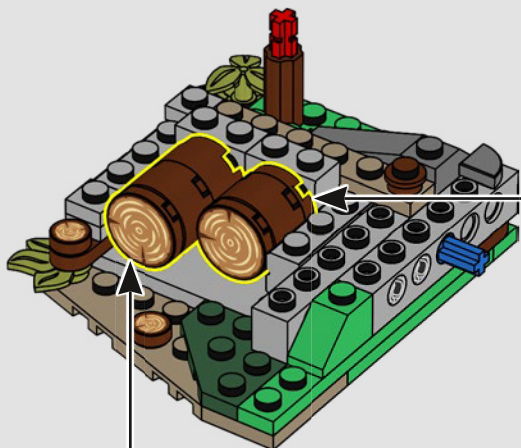

148

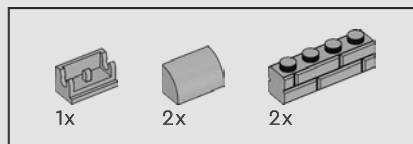
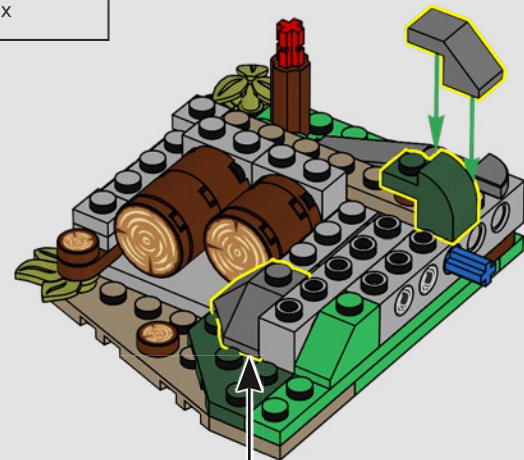

149

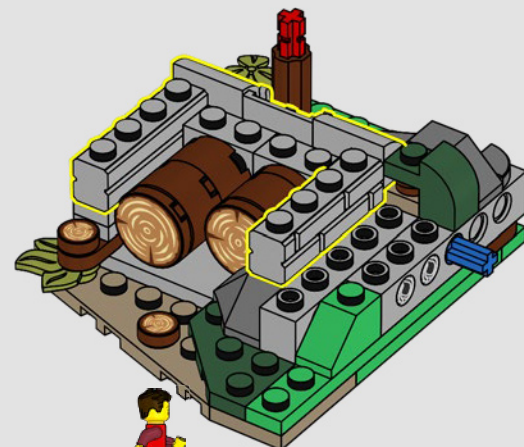



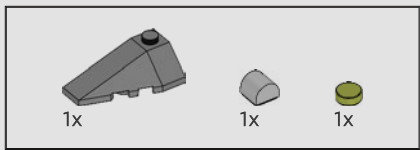

150

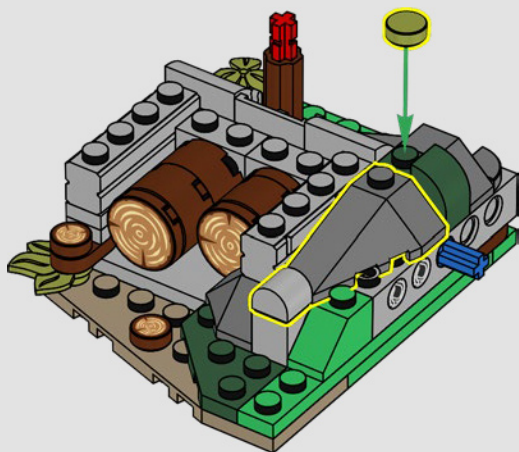

151

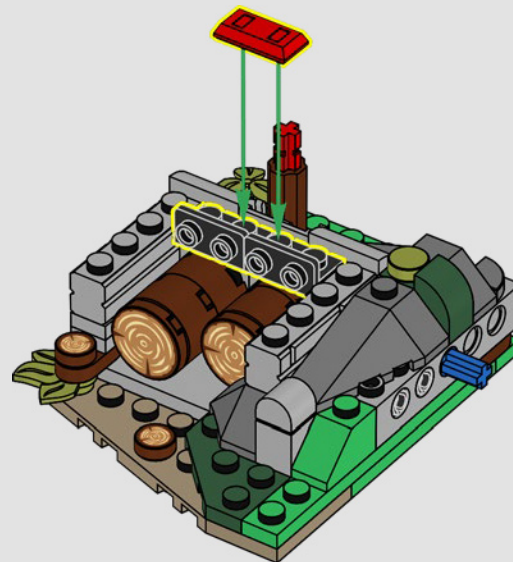

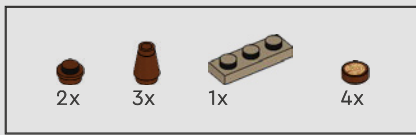

152

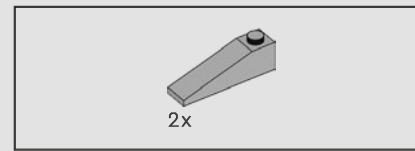
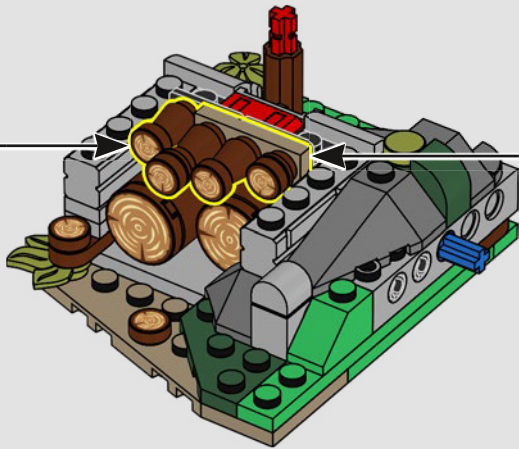
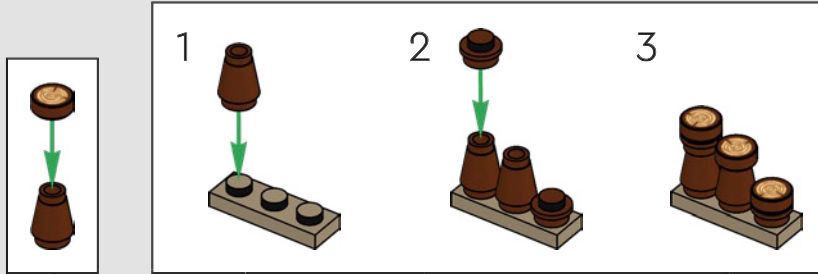

153

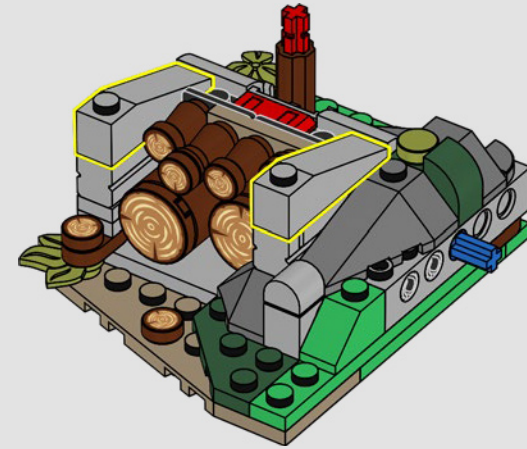



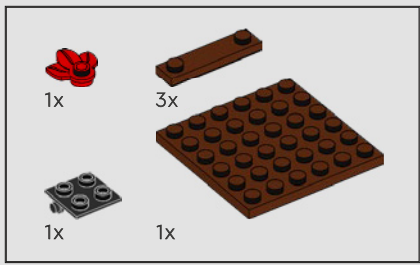

154

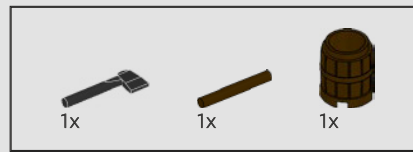
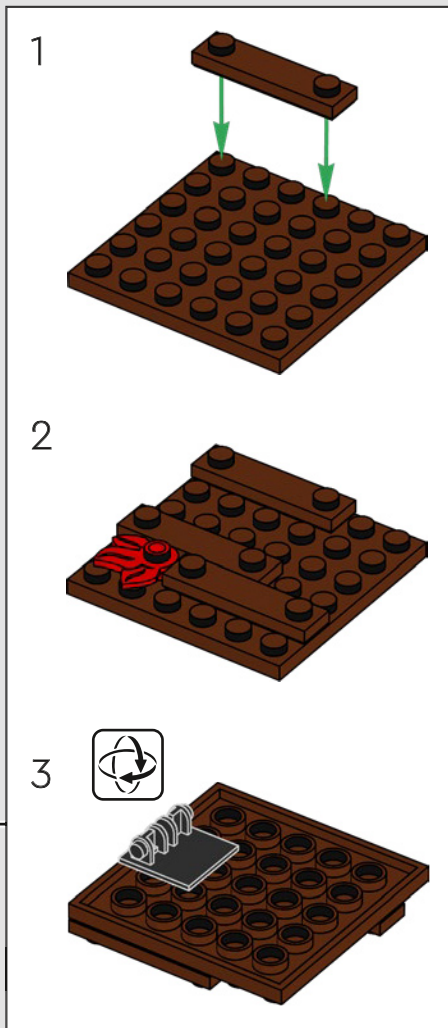
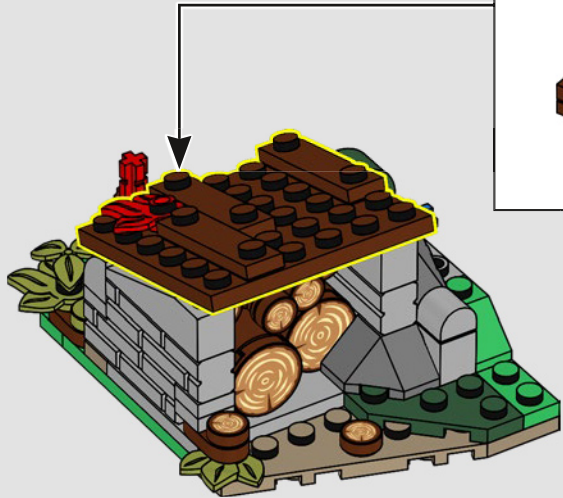

155

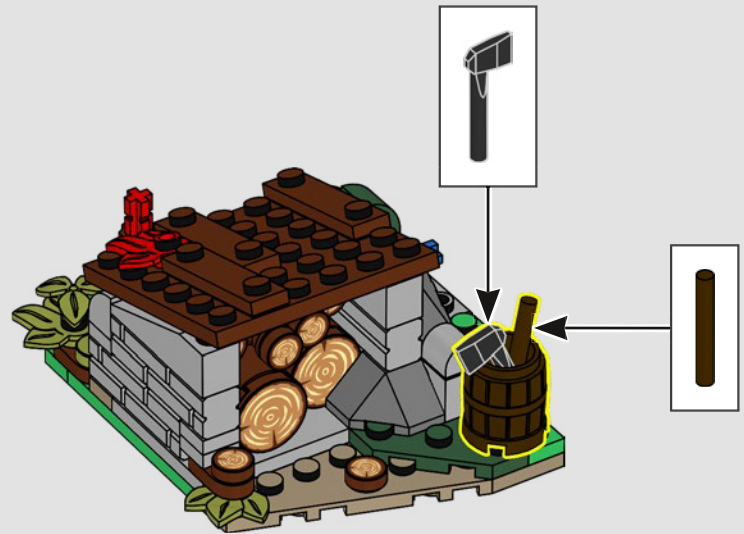

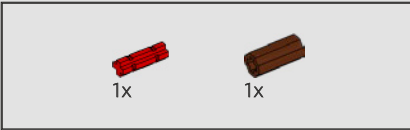
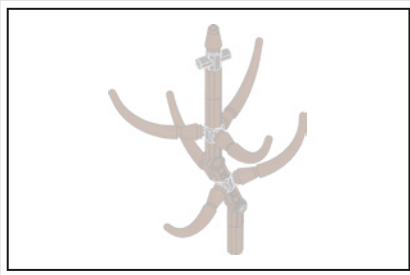

156



157

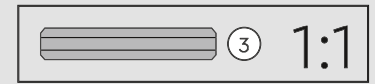
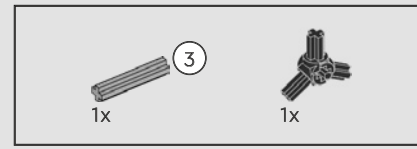
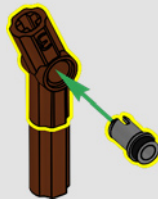

158

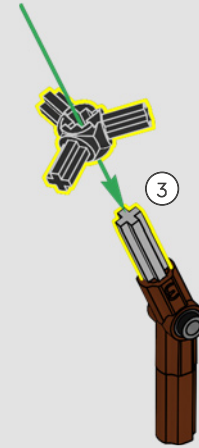

159







160

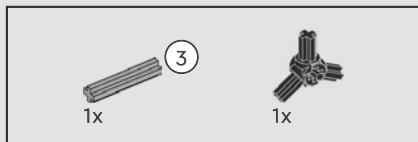
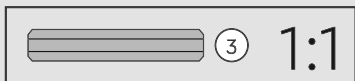

161



162



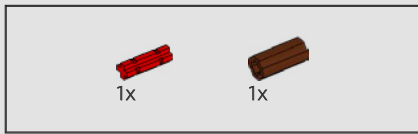

163

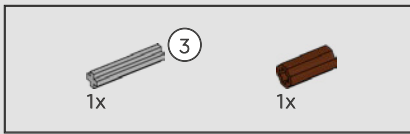
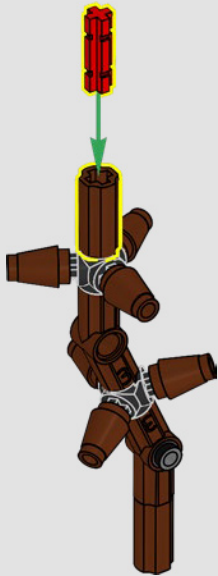

164

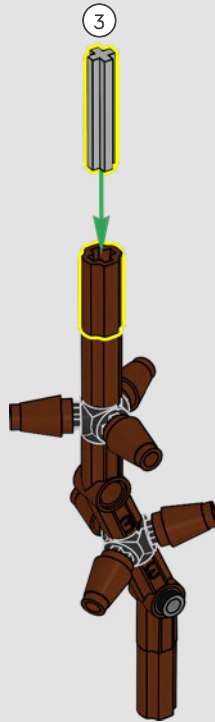

165

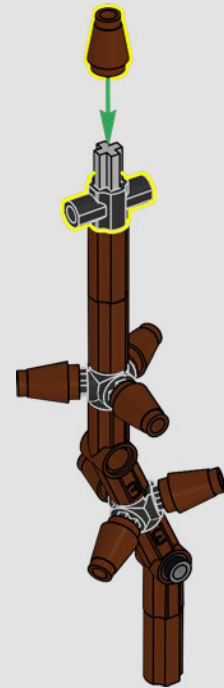





166

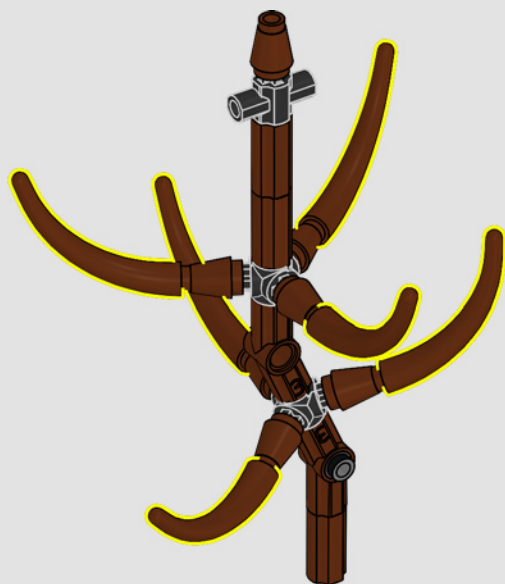

167

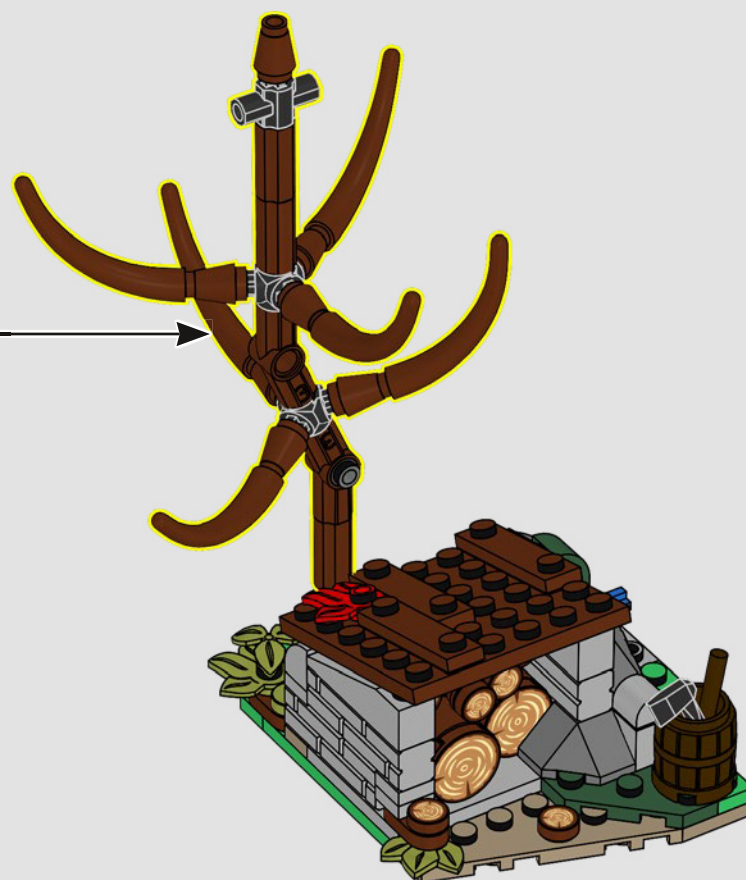

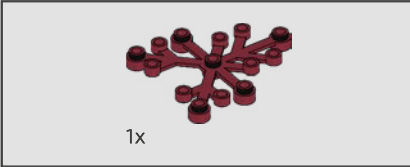
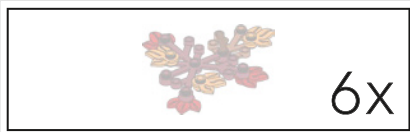

168

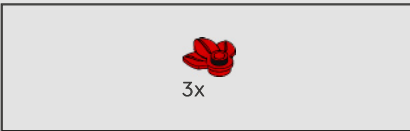
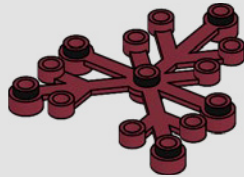

169

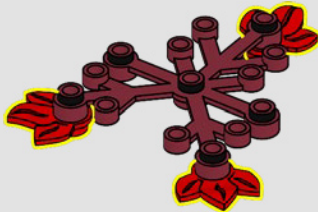

170

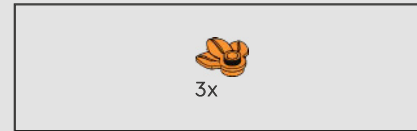
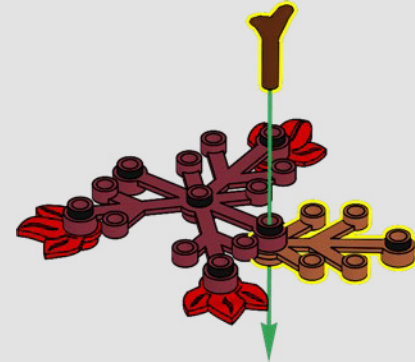

171

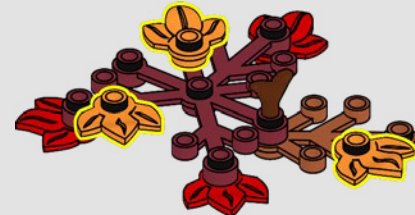

6x





172

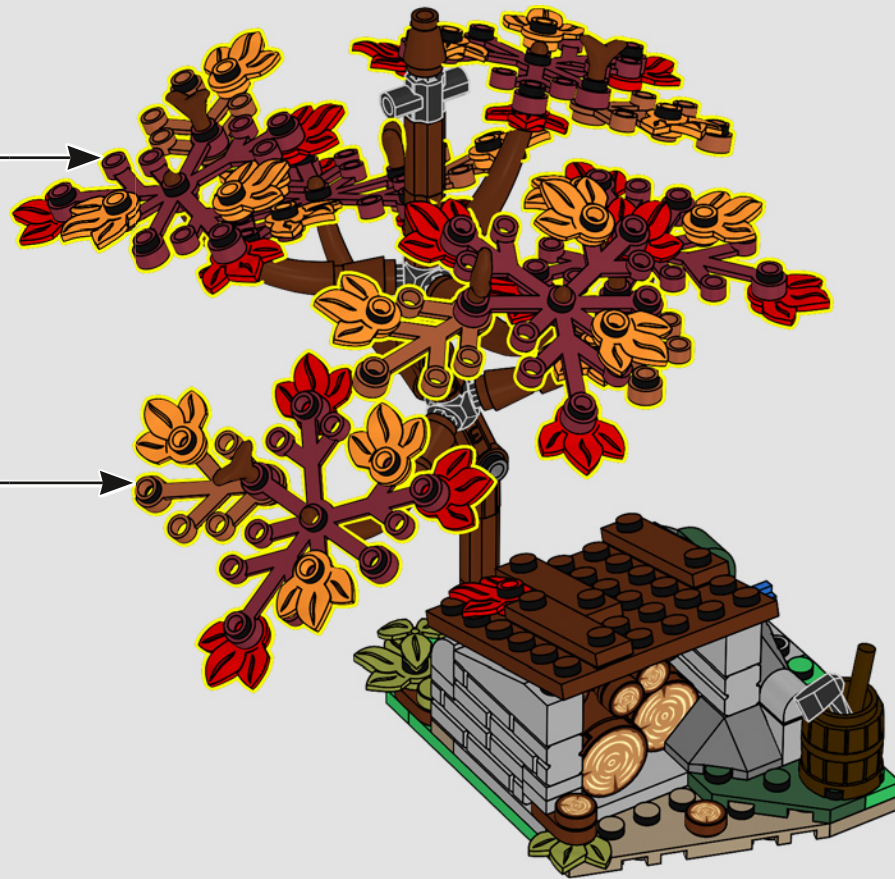

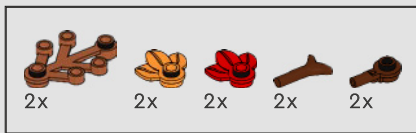

173

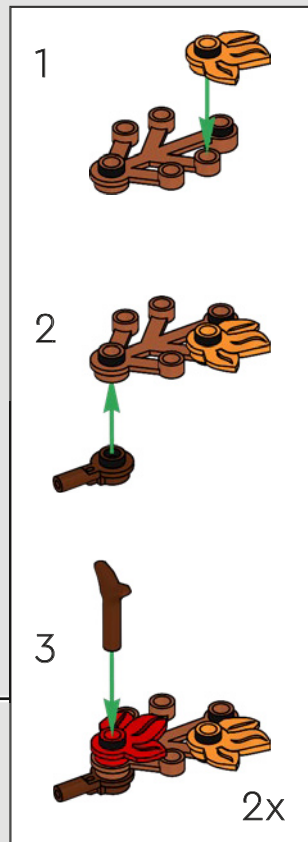
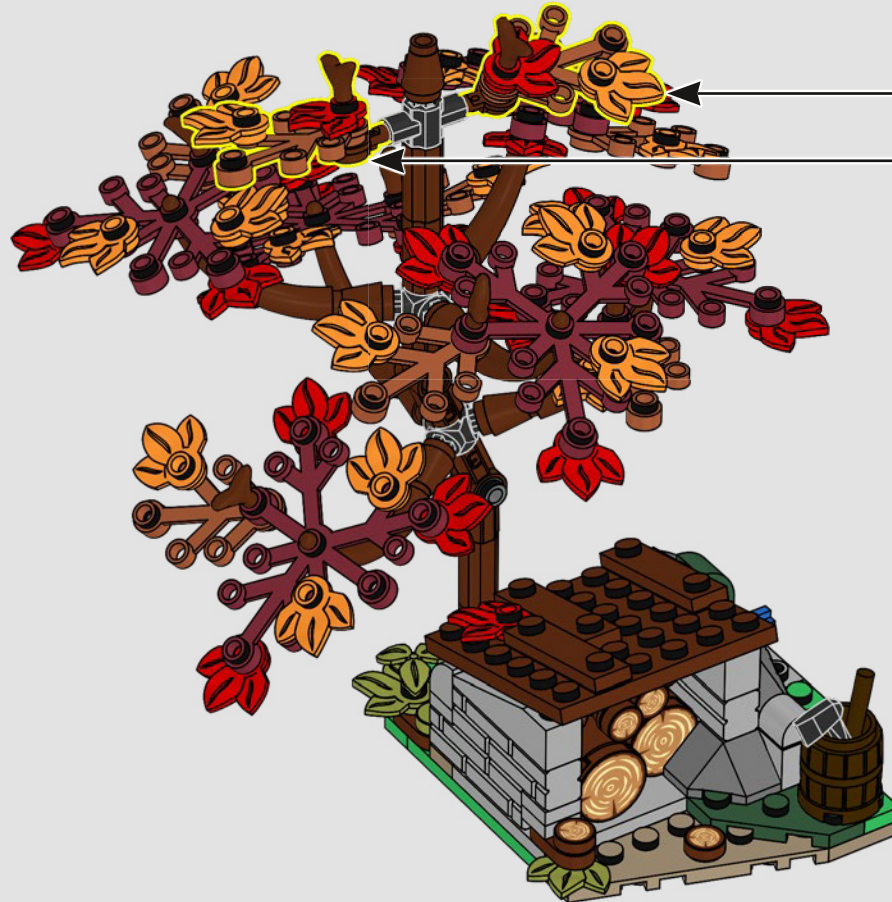



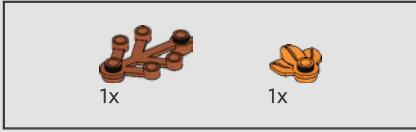
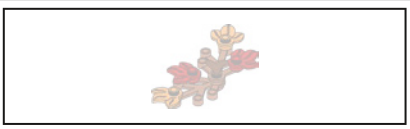

174

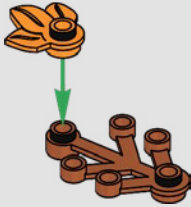

175

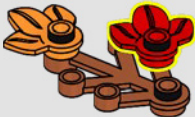

176

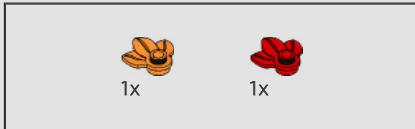

177



178

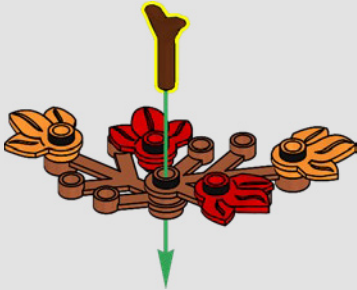

179





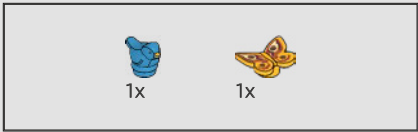

180

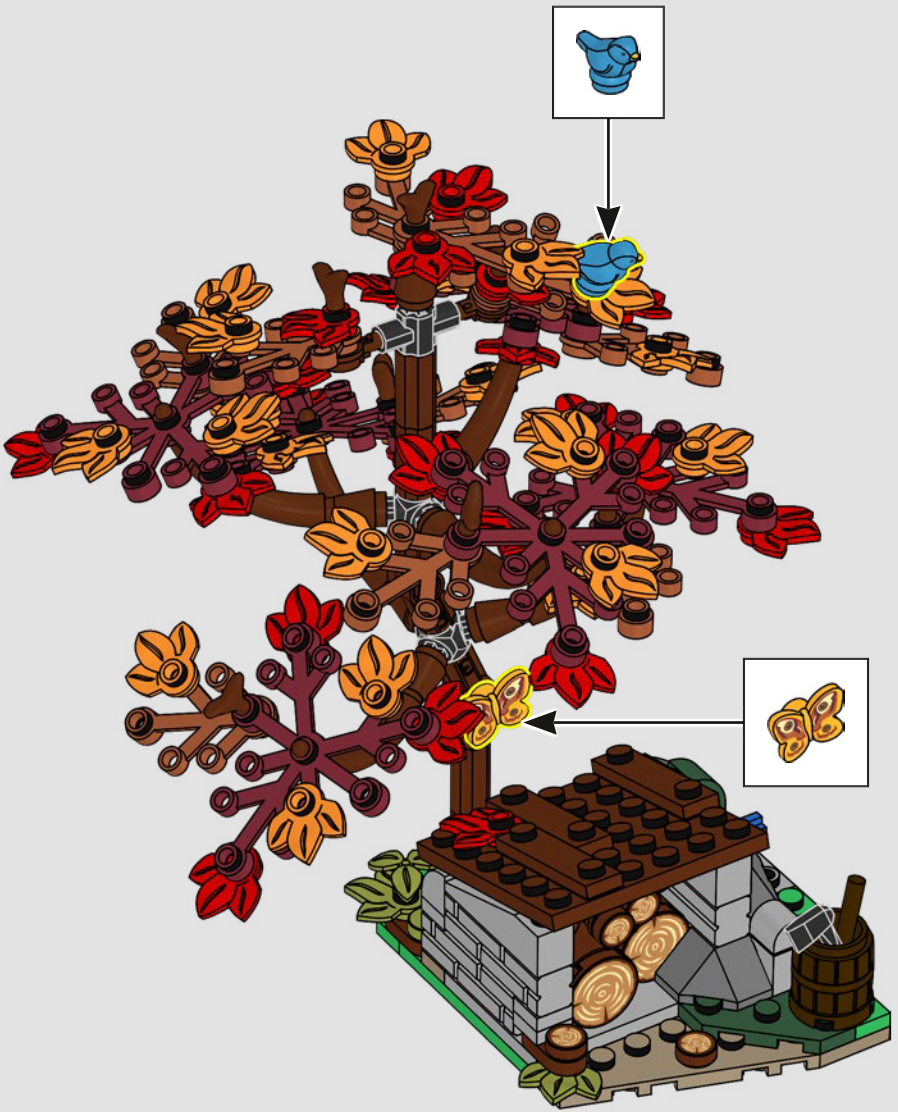

181

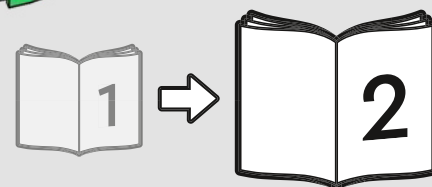





# IDEAS

GATHER SUPPORT  
OBTENEZ DE L'APPUI  
OBTÉN APOYOS

SHARE YOUR IDEA  
PARTAGEZ VOTRE IDÉE  
COMPARTE TU IDEA

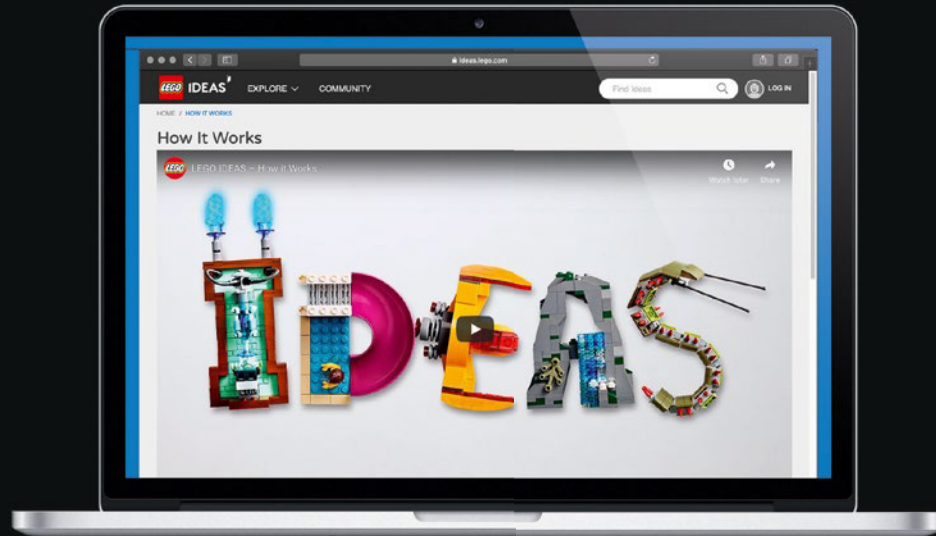
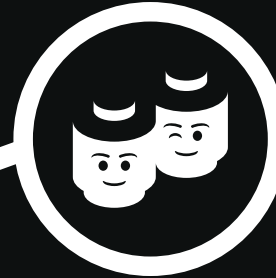
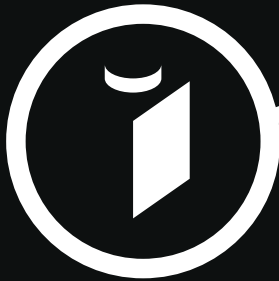

NEW LEGO® PRODUCT  
NOUVEAU PRODUIT LEGO®  
NUEVO PRODUCTO LEGO®

LEGO® REVIEW  
EXAMEN LEGO®  
REVISIÓN DE LEGO®

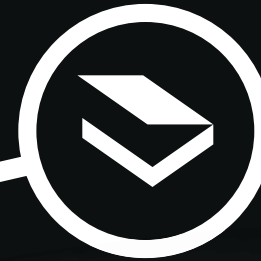

[ideas.LEGO.com](https://ideas.LEGO.com)



1x 6285620  
1x 6206149  
1x 6168642  
2x 6235083  
1x 6286834  
2x 6046905  
1x 6132824  
1x 6357680  
4x 306901  
2x 6248490  
2x 4667575  
2x 6285777  
1x 6265695  
1x 6320300  
1x 6413018  
1x 6415097  
2x 6126046

3x 6400127  
1x 6323424  
1x 4527637  
1x 6422640  
1x 6294284  
2x 6249091  
2x 366601  
22x 4161734  
2x 4529237  
2x 4113915  
2x 4125253  
1x 6170568  
2x 6365720  
4x 6212758  
2x 6092587  
1x 4159196

2x 4217562  
6x 6372047  
3x 6221467  
2x 6173057  
2x 6132769  
1x 6205345  
3x 4113916  
2x 4114001  
4x 6349727  
1x 306221  
1x 6223427  
1x 6399031  
1x 459921  
1x 6337734  
2x 302421

23x 6372723  
19x 4142865  
4x 302321  
2x 6394880  
1x 6434947  
8x 302121  
4x 614123  
4x 4206482  
2x 6299413  
1x 6300104  
1x 6271746  
1x 6226749  
1x 6182787  
1x 6270417  
8x 302424  
22x 6286830  
1x 4599378

1x 73587  
1x 6171840  
7x 6168646  
2x 6186675  
4x 6284070  
1x 306226  
3x 6278152  
2x 6203937  
1x 6121485  
1x 6088585  
2x 6227901  
2x 6335388  
6x 4558954  
2x 6344819  
4x 6380236

1x 6245281  
2x 6291068  
1x 6325525  
6x 6210270  
1x 6141554  
1x 6141556  
1x 6371584  
1x 4537551  
1x 6323421  
2x 4548180  
2x 6051508  
2x 6431014  
3x 403226  
1x 4216660  
8x 6279875  
1x 6195273

1x 474026  
2x 6179182  
5x 6280097  
1x 4106552  
1x 452826  
1x 6391202  
3x 302326  
3x 4144024  
2x 6156991  
9x 6173119  
5x 6000650  
2x 6020193  
4x 6310268  
6x 6390386  
1x 6234806  
3x 302226

1x 6053077  
2x 4163373  
1x 4124096  
2x 6089119  
1x 383526  
2x 408326  
1x 6218700  
3x 302126  
5x 6066113  
6x 371026  
6x 302026  
2x 4529155  
1x 6039194

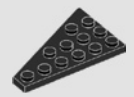

7x  
6258209

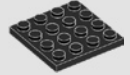

2x  
4243819



4x  
6173121



2x  
379526



7x  
6258214



4x  
303426



2x  
4514845



1x  
244526

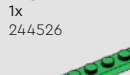

2x  
346028



3x  
6021999

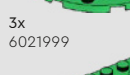

1x  
4507311

2x  
6171101



1x  
6229130



7x  
302328



1x  
4121969



2x  
6206150



1x  
6380676



2x  
6314378



1x  
4143562



3x  
6244915



1x  
6270030



1x  
6254484



1x  
6384077



5x  
6092602



1x  
6344066



2x  
6290986



17x  
6022079



9x  
6074892



1x  
6357937



2x  
6394948



4x  
6240030



6x  
6223655



2x  
6166107



16x  
6254552



5x  
6253734



1x  
6240225



1x  
6238677



3x  
6396287



3x  
6292200



2x  
6240222



1x  
6252049



1x  
6247793



1x  
6240221



1x  
6238046



2x  
6247364



1x  
6329591



1x  
4518029



1x  
6223631



2x  
6231925



22x  
6253884



3x  
4159007



1x  
6240515



2x  
6422225



1x  
4267425



5x  
6198156



2x  
6055172



4x  
6273590



30x  
4549436



8x  
6040126



2x  
6021969



1x  
6227249



12x  
6092591



5x  
4528604



2x  
6275485



1x  
6028018



1x  
6028022



4x  
4255416



10x  
6356427



1x  
6264092



6x  
6132768



9x  
6329820



12x  
6175927



7x  
6257599



1x  
6164288



19x  
6015424



10x  
4507047



1x  
6395743



1x  
6022043



12x  
4251796



2x  
6114515



2x  
4631385



1x  
6384911



1x  
6299536



1x  
4505985



1x  
6398599



2x  
6224472



4x  
4205004



1x  
6273588



1x  
6392975



1x  
6214814



1x  
6214813



29x  
6400754



1x  
4226869



1x  
6400283



8x  
6013102



3x  
6411352



16x  
6382733



2x  
6254478



2x  
4528778



6x  
6013975



4x  
6328333



6x  
4543949



4x  
6020923



2x  
6262972



5x  
6431820



1x  
6223733



1x  
6287960



4x  
4625032



1x  
6287960



4x  
4625032





4x  
6403175

4x  
6400309

2x  
6075617

2x  
6184432

2x  
6223171

7x  
6328339

1x  
6227073

8x  
6387139

1x  
6267486

3x  
6335330

2x  
6359692

10x  
4585751

2x  
6359685

148

4x  
6341471

2x  
6341767

3x  
4539090

3x  
4539097

2x  
6411330

1x  
6410687

6x  
6186003

1x  
6360045

6x  
6431823

2x  
4618986

2x  
6357747

1x  
6318085

2x  
6422641

1x  
6439231

8x  
6273388

12x  
6285623

5x  
4216581

4x  
6201911

2x  
4225469

2x  
6401395

12x  
6341553

19x  
6248944

8x  
6306775

2x  
6337003

4x  
4211159

2x  
6182435

1x  
6268828

4x  
4211166

2x  
6172808

10x  
6186673

25x  
4529242

1x  
4626196

8x  
4211288

24x  
4211151

2x  
6092590

6x  
6117976

1x  
6425514

2x  
4211210

4x  
4211257

4x  
6196221

10x  
6146301

1x  
4211206

2x  
6261388

5x  
4211180

21x  
6078605

22x  
4531751

13x  
6397820

2x  
6333110

1x  
6427273

8x  
4211220

1x  
6096217

41x  
6100769

4x  
4211195

1x  
6103769

2x  
6116613

6x  
4211189

15x  
6153594

17x  
4211190

40x  
6257604

4x  
6092659

3x  
4211201

2x  
6170468

24x  
6372430

10x  
4221590

3x  
4211204

2x  
4609635

2x  
6326103

1x  
4277751

- 10x 6341968
- 9x 4211183
- 33x 6062574
- 4x 4263776
- 72x 4585337
- 3x 4271874
- 4x 4211211
- 1x 4217848
- 2x 4223683
- 12x 4222627
- 9x 4225700

- 1x 6326748
- 1x 6329581
- 3x 6343322
- 6x 6258831
- 2x 4211503
- 2x 6225242
- 13x 4211399
- 2x 6329584
- 4x 6227184
- 4x 6123809
- 1x 4211469
- 1x 4211644
- 20x 4211353
- 2x 6212077
- 5x 4211387

- 4x 6262085
- 4x 6248078
- 1x 6335378
- 18x 6004729
- 2x 4211512
- 2x 4550325
- 2x 6134378
- 2x 6093859
- 2x 4211398
- 1x 4211473
- 1x 6330090
- 2x 6028811
- 2x 4211393

- 11x 4211815
- 2x 6211969
- 4x 4645397
- 4x 4211396
- 6x 4211441
- 8x 6314891
- 1x 4622803
- 2x 6013497
- 1x 4211838
- 6x 6037399
- 2x 4514846
- 2x 4211366

- 2x 4211466
- 9x 4211452
- 3x 4211481
- 7x 6284595
- 3x 6285465
- 28x 6398008
- 5x 6278087
- 3x 6031787
- 1x 6152229
- 2x 6278987
- 1x 6199910
- 1x 6170292

- 1x 4633691
- 1x 6363149
- 2x 6236213
- 2x 4624615
- 5x 4619636
- 1x 6245499
- 1x 6287309
- 6x 4211044
- 3x 6344022
- 2x 6362259
- 3x 6199549
- 7x 6336390
- 1x 6321350
- 1x 4211051
- 2x 6390673
- 11x 6296892
- 2x 6055313
- 1x 6120935
- 6x 4211063

- 1x 6344738
- 4x 6177079
- 1x 6015356
- 1x 6352694
- 3x 4211105
- 2x 4210867
- 2x 4210866
- 2x 4539429
- 6x 4210997
- 1x 6311001
- 2x 4210706
- 2x 6000970

- 3x 6092572
- 4x 6168776
- 3x 4211109
- 7x 6227909
- 1x 6170420
- 1x 4211006
- 4x 6395635
- 1x 6284587
- 1x 6335932
- 5x 6190252
- 1x 6287847
- 1x 6372427
- 30x 6219088

- 1x 6434969
- 1x 6409759
- 2x 6420457
- 2x 6395410
- 13x 6177146
- 14x 6218358
- 17x 6292154
- 12x 6431822
- 1x 6337061
- 1x 6295464
- 12x 6102995
- 4x 6313600

- 21x 6056383
- 10x 6292145
- 15x 6257605
- 43x 6021997
- 33x 6102998
- 1x 6160320
- 1x 6035734
- 2x 6397821
- 3x 6272111



 [LEGO.com/service](https://www.LEGO.com/service)





# YOU COULD WIN



## YOU COULD WIN

Your feedback will help shape the future development of this product series.

Visit:

## DU KÖNNTEST GEWINNEN

Dein Feedback trägt zur Weiterentwicklung dieser Produktreihe bei.

Geh auf:

## VOUS POURRIEZ GAGNER

Vos commentaires nous aideront à concevoir les futurs produits de cette gamme.

Visitez :

## POTRESTI VINCERE TU

La tua opinione ci aiuterà a migliorare la creazione futura di questa linea di prodotti.

Visita:

## PUEDES GANAR

Tu opinión contribuirá al futuro de esta serie de productos.

Visita:

## 轻松获奖

您的反馈将有助于我们在今后改进本产品系列。

请访问:

---

# LEGO.com/productfeedback

---

You also have the chance to win a LEGO® set.

Terms and conditions apply.\*

Außerdem hast du die Chance, ein LEGO® Set zu gewinnen.

Es gelten die Teilnahmebedingungen.\*

Vous pourriez également gagner un ensemble LEGO®.

Des conditions s'appliquent.\*

Hai anche la possibilità di vincere un set LEGO®.

Termini e condizioni sono applicabili.\*

También tienes la oportunidad de ganar un set LEGO®.

Aplican términos y condiciones.\*

您还有机会赢取乐高®套装。

条款和条件适用。\*

\*[LEGO.com/productfeedback-terms](https://www.lego.com/productfeedback-terms)

