



Disney
**MICKEY
MOUSE**

21317



Steamboat Willie

Without a doubt, Disney's 1928 cartoon *Steamboat Willie* represents a series of cultural and historically significant firsts: the first cartoon with fully synchronized sound, the first fully post-produced soundtrack, among the first films ever to be storyboarded and finally distributed and the first public appearance of the cheeky mouse that would go on to become one of the world's most beloved personalities.

All in all, *Steamboat Willie* was a groundbreaking achievement in the world of motion pictures...

But more than that, this short, black and white cartoon represents Walt Disney's creativity and determination; two qualities that are also embedded in the ethos behind LEGO® Ideas.

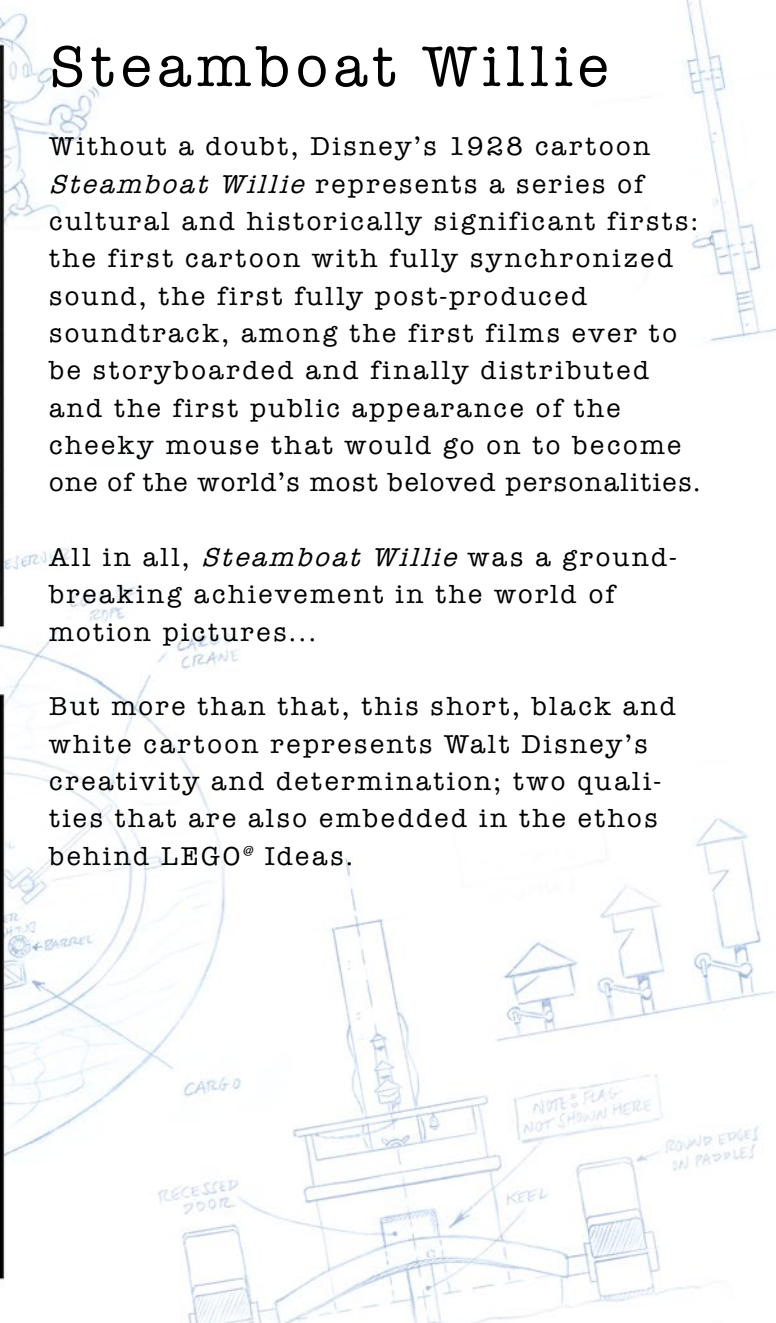
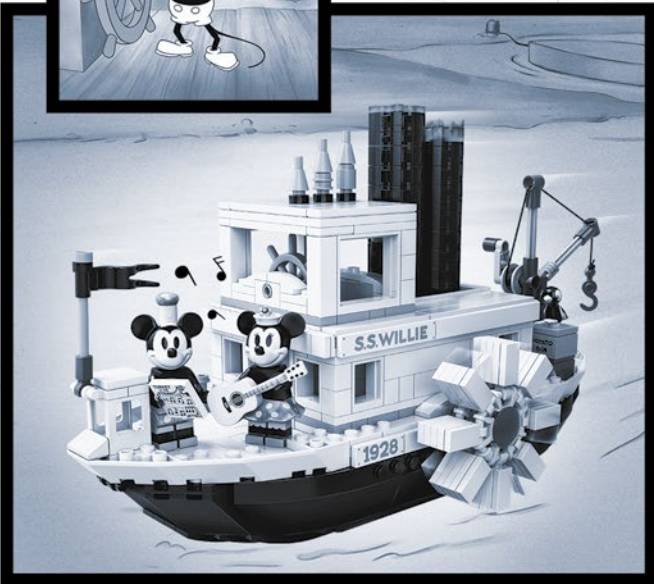
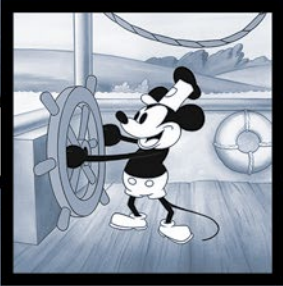

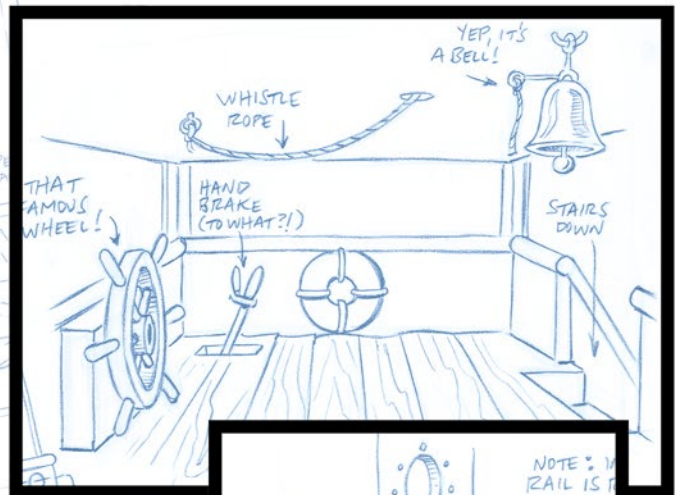
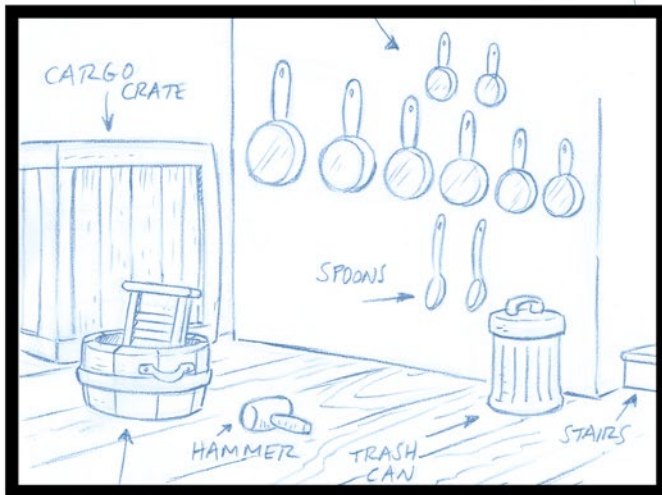

Disney was convinced that sound would bring a real sense of magic and humor to the cartoon...and it truly did. His sense of storytelling and drive for technical innovation prevailed and led to International fame for both Walt Disney and Mickey Mouse. 90 years later, The Walt Disney Company still represents the world's best storytelling and innovation in animation.

We are proud to present this model and hope it builds a little of that sense of magic that *Steamboat Willie* did when it was first screened.

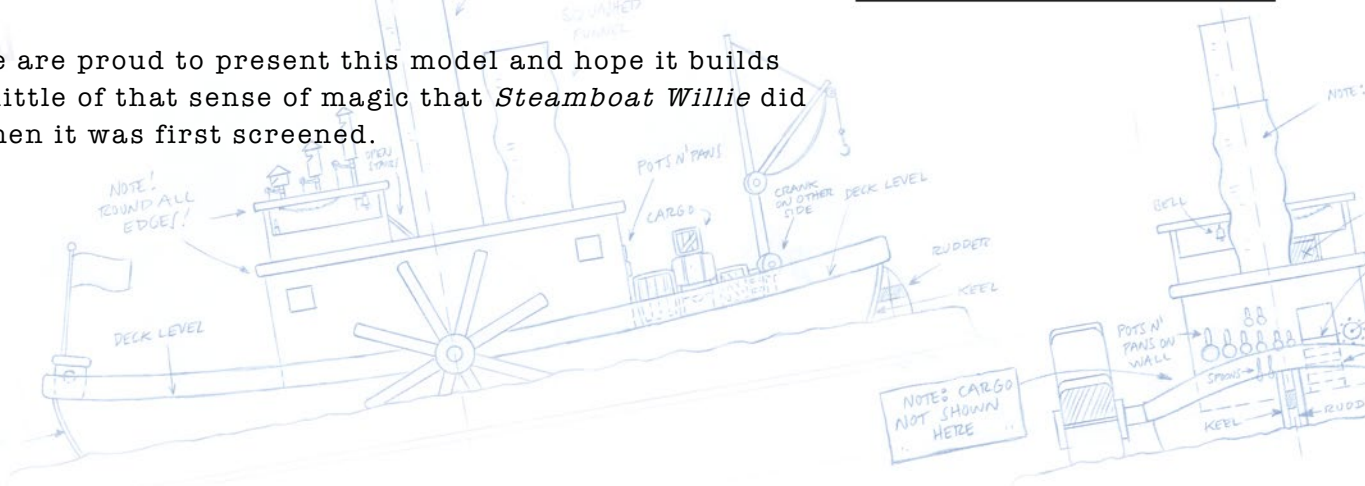

Máté's
favorite...

...LEGO® set:

Main Street (6765),
it's very playable
and there are lots
of hidden surprises
in it.

...element:

The 85861 LEGO
Plate 1 x 1 Round
with Open Stud is
very handy, because
it can link shafts
and plates and other
kinds of bricks.

...LEGO designer:

MetalBeard's Sea
Cow designers
Michael Fuller,
Jordan David Scott
and Chris Stamp

...Fan/community
designer:

Amongst others,
Kevin Szeto creator
of the LEGO Ideas
Beatles Yellow
Submarine

Meet the Designers

Máté Szabó Fan Designer, Budapest, Hungary

Máté is a professional animator who loves to shoot and make videos and of course, LEGO® creations. See his Instagram feed: @szabolego.

"I loved playing with LEGO bricks as a child and still love the way the system works. It teaches me so much about thinking in a greater context.

I am inspired by Disney characters, cartoons and movies and wanted to pay my respect to the brilliant artists who create those masterpieces. When I saw the classic Mickey Mouse from the Disney Minifigure series, I started thinking about *Steamboat Willie*.

When creating the model, I re-watched the short as many times as I could and searched for layout drawings for accuracy. But I also had to reduce the number of elements in the model and make it more simplistic too. The most difficult part was the hull of the boat, where I tried to make it as round as possible. It took about 3 months to complete the model, working on it a couple hours in a day.

It was an amazing honor to reach the magic 10,000 votes. The hardest part came after the 5,000-vote milestone. It was a real push because we only had 44 days before the deadline. I really want to thank everyone who was involved.

To those in the LEGO Ideas community, my advice is to be yourself and create something that you're interested and love. That's it."





John Ho, LEGO® Designer

“I watched *Steamboat Willie* at university and was amazed by the fact that it was the first Disney cartoon with synchronized sound and Mickey Mouse’s first appearance on screen. I hope to bring that moment of amazement and wonder to everyone who builds this model.

My job is to translate the great LEGO® Ideas fan submission into a great LEGO product with an enjoyable building flow, unique details and fun play experience. So many details of the Original are creatively represented in this model. The challenge was keeping those great details, while adding in a function. It is so fun to push the model around and see the paddles and smoke stacks move!



Steamboat Willie is a hugely important landmark in the history of Disney animation, so representing it in LEGO bricks was an honor that made every work day feel unique and special.”

Crystal Bam Fontan, LEGO Graphic Designer

“*Steamboat Willie* is such a timeless classic and Mickey will always be a fan favorite so to be a part of the development of this set was a huge honor!

As a LEGO Graphic Designer, my job is to try and fulfill the Fan Designer’s dreams, as much I can achieve through graphics. Máté Szabó really managed to add a lot of detail to his submission.

With this set we added Minnie and the multiple decorated elements. The most challenging part was to make the Mickey and Minnie minifigures really stand out since they are the main characters. I decided to add some extra vivacity with silver details on their accessories and on the *S.S. Willie* to give it that extra pop! As a fun Easter egg we featured the goat from the short as part of the decorated music sheet element.



Steamboat Willie

Aucun doute, le film d'animation *Steamboat Willie*, réalisé par Disney en 1928, représente une série de premières culturelles et historiques importantes : il s'agit du premier film d'animation au son entièrement synchronisé, de la première bande sonore entièrement conçue en post-production, de l'un des premiers films entièrement conçus à partir de scénari-mages à être distribué, et de la première apparition publique de la souris culottée qui deviendra l'une des personnalités les plus appréciées au monde.

Dans son ensemble, *Steamboat Willie* constitue une avancée révolutionnaire dans le monde du cinéma.

Mais, plus encore, ce court-métrage d'animation en noir et blanc révèle la créativité et la détermination de Walt Disney, deux qualités également intégrées dans la philosophie qui se trouve derrière LEGO® Ideas.

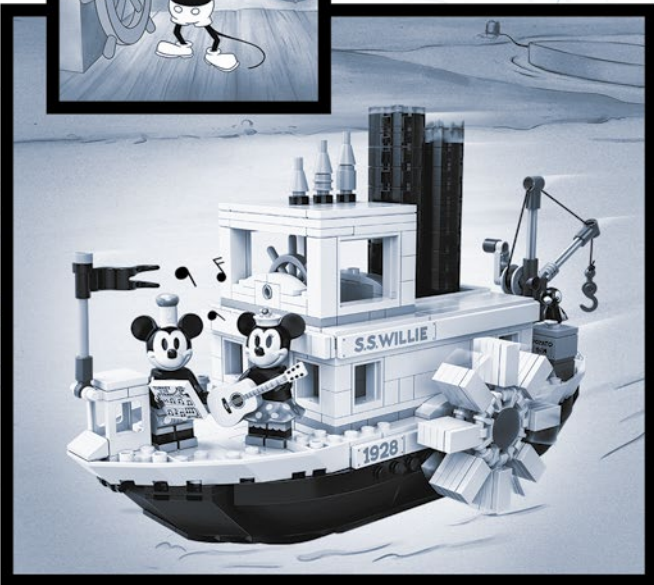
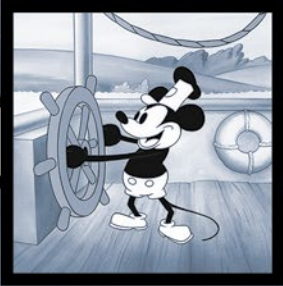

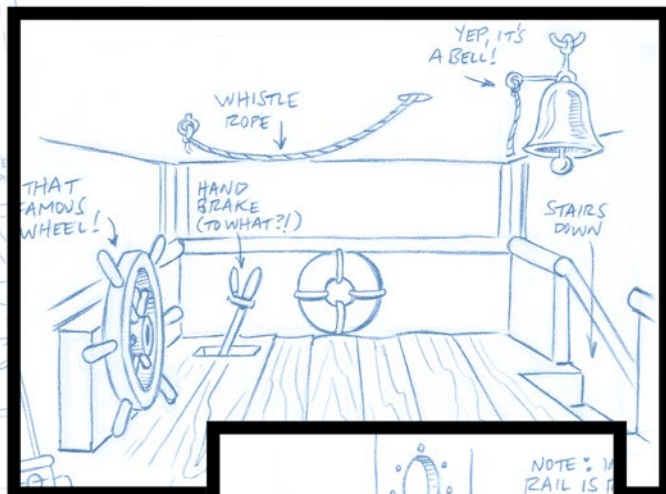
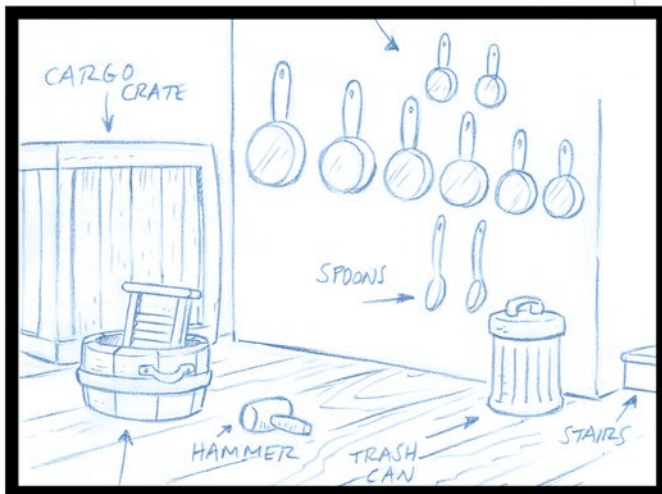

Disney était convaincu que le son renforcerait l'esprit de magie et d'humour du cinéma d'animation... et il a eu bien raison. Son sens de la narration et sa soif d'innovation technique sont les fondements de sa réussite et de sa renommée internationale, de même que celle de Mickey Mouse. 90 ans plus tard, la Walt Disney Company est toujours chef de file en narration et en innovation du cinéma d'animation à l'échelle mondiale.

C'est donc avec une grande fierté que nous présentons ce modèle, et nous espérons qu'il saura apporter la même touche de magie que celle créée par le lancement de *Steamboat Willie*.

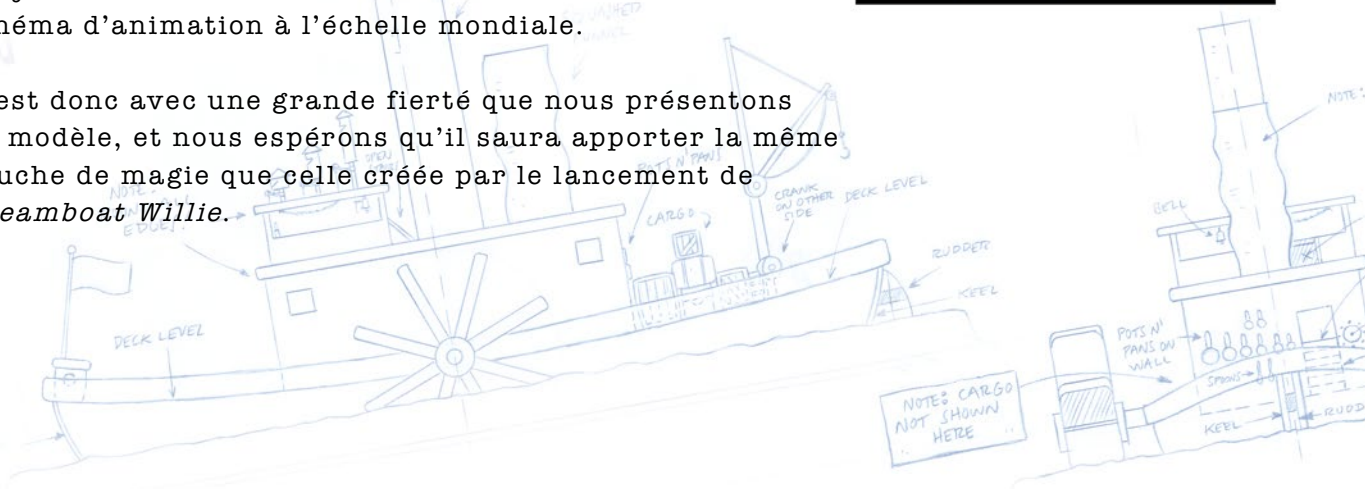

Les coups de cœur de Máté

Ensemble LEGO® :

La rue principale (6765), parce qu'il est très jouable et qu'il cache un tas de surprises.

Élément :

La plaque LEGO ronde 1 x 1 (85861) à tenon ouvert est très pratique, car elle permet de relier des conduits, des plaques et d'autres types de briques.

Concepteur LEGO :

Les concepteurs du Lamantin de Barbe de Métal, Michael Fuller, Jordan David Scott et Chris Stamp.

Concepteur amateur/de la communauté :

Entre autres, Kevin Szeto, le créateur de LEGO Ideas qui a conçu le Yellow Submarine des Beatles.

Rencontre avec les concepteurs



Máté Szabó, concepteur amateur, Budapest, Hongrie

Máté est un dessinateur d'animation professionnel qui adore tourner et produire des vidéos et, bien sûr, réaliser des créations LEGO®. Jetez un œil à son compte Instagram : @szabolego.

« J'adorais jouer avec les briques LEGO lorsque j'étais enfant, et j'aime toujours autant la façon dont fonctionne le système. Cela m'apprend réellement à voir plus loin que le bout de mon nez.

Je me sens inspiré par les personnages, les films d'animation et les autres films de Disney et j'ai voulu rendre hommage aux brillants artistes qui créent ces chefs-d'œuvre. Quand j'ai vu la figurine de Mickey Mouse classique dans la série des figurines de Disney, j'ai pensé à *Steamboat Willie*.

En créant le modèle, j'ai regardé le court-métrage autant de fois que j'ai pu et j'ai cherché des dessins de référence pour y rester fidèle. J'ai néanmoins dû réduire le nombre d'éléments à inclure dans le modèle pour garder une certaine simplicité. La partie la plus difficile a été la coque du bateau, que j'ai essayé d'arrondir le plus possible. Il a fallu environ 3 mois pour créer le modèle, à coup de quelques heures de travail par jour.

C'est un honneur incroyable d'avoir réussi à atteindre le nombre magique de 10 000 votes. La partie la plus dure est venue après l'étape des 5 000 votes. C'était un véritable défi à relever, car nous avons alors seulement 44 jours avant la date limite. Je tiens sincèrement à remercier toutes les personnes qui ont contribué à cette réussite.

Aux membres de la communauté LEGO Ideas, mon conseil est de rester vous-mêmes et de créer des choses qui vous intéressent et que vous aimez. C'est tout. »



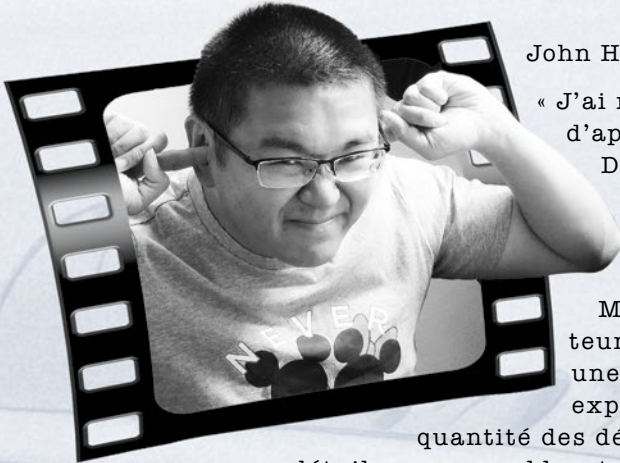

John Ho, concepteur LEGO®

« J'ai regardé *Steamboat Willie* à l'université et j'ai été surpris d'apprendre qu'il s'agissait du premier film d'animation de Disney au son synchronisé, en plus d'être la première apparition de Mickey Mouse à l'écran. J'espère pouvoir transmettre ce moment d'étonnement et d'émerveillement à tous ceux qui construiront ce modèle.

Mon travail consiste à traduire les propositions des amateurs de LEGO® Ideas en un excellent produit LEGO qui offre une construction agréable, des détails uniques et une expérience de jeu amusante. Ce modèle comprend une grande quantité des détails créatifs de l'original. Le défi était de reprendre ces détails remarquables, tout en ajoutant une fonction au modèle. C'est si amusant de pousser le modèle pour voir le mouvement des roues à aubes et des cheminées !

Steamboat Willie constitue un jalon très important dans l'histoire de l'animation de Disney, donc c'était pour moi un honneur de le représenter en briques LEGO. C'est pourquoi chaque jour de travail m'a paru unique et spécial. »



Crystal Bam Fontan, graphiste LEGO

« *Steamboat Willie* est un classique intemporel et Mickey sera toujours un favori du public, alors j'étais ravie de pouvoir contribuer à la conception de ce modèle !

Comme graphiste LEGO, mon travail consiste à tenter de réaliser autant que possible les rêves du concepteur amateur au niveau graphique. Máté Szabó a réussi à inclure beaucoup de détails dans sa proposition.

Nous avons ajouté Minnie et plusieurs éléments décoratifs à l'ensemble. La partie la plus difficile a été de concevoir les figurines de Mickey et de Minnie de manière à ce qu'ils se démarquent puisque ce sont les personnages principaux. J'ai décidé d'ajouter de la vivacité grâce à des détails argentés sur les accessoires ainsi que sur le bateau Willie pour lui donner encore plus d'éclat !

Nous avons aussi voulu faire un autre clin d'œil au court-métrage en intégrant la chèvre du film à la feuille de musique décorée. »

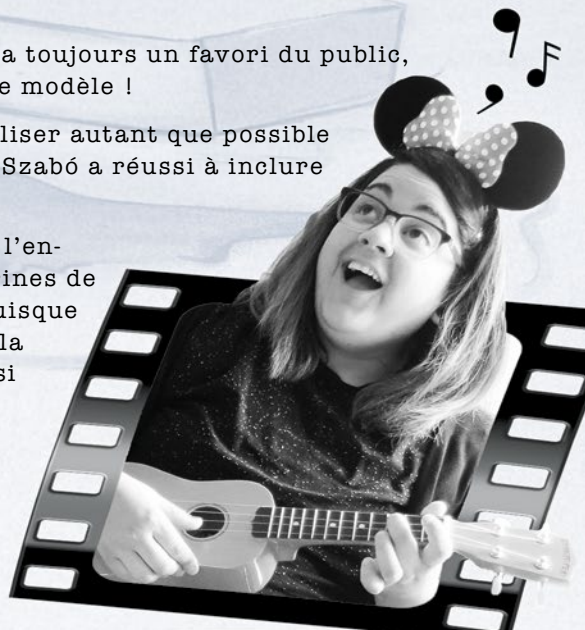

El Barco De Vapor Willie

El cortometraje de dibujos animados *El Barco De Vapor Willie*, estrenado por Disney en 1928, fue sin duda notablemente pionero en los ámbitos cultural e histórico: hablamos no sólo de la primera caricatura con sonido totalmente sincronizado, la primera banda sonora totalmente postproducida y una de las primeras películas que partió de un guion gráfico y fue finalmente distribuida, sino también de la primera aparición pública de un alegre ratoncito que se convertiría en uno de los personajes más entrañables del mundo.

En definitiva, *El Barco De Vapor Willie* fue un logro revolucionario en el mundo del cine.

Pero, por encima de eso, esta breve historieta animada en blanco y negro representa la creatividad y la determinación de Walt Disney, dos cualidades que también forman parte de la filosofía en la cual se fundamenta LEGO® Ideas.

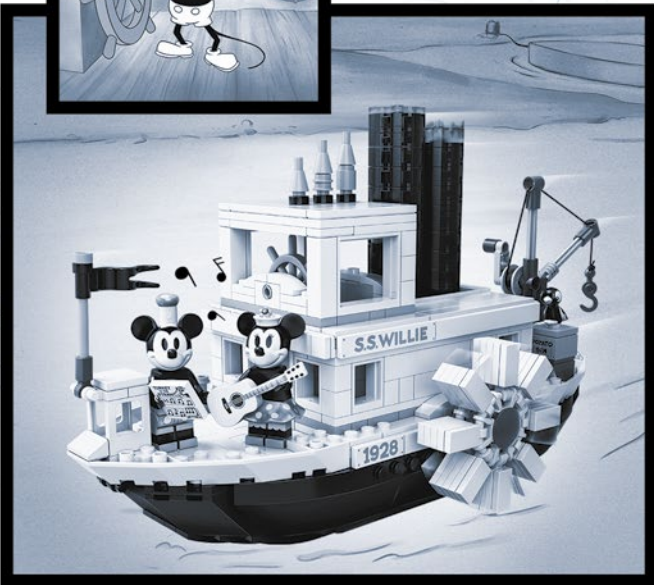

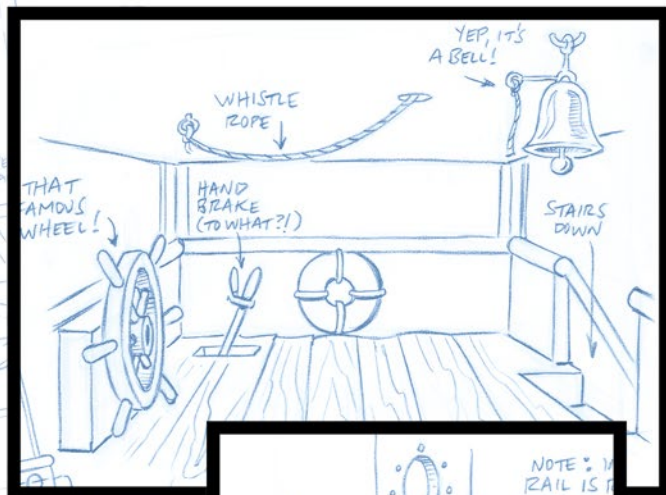
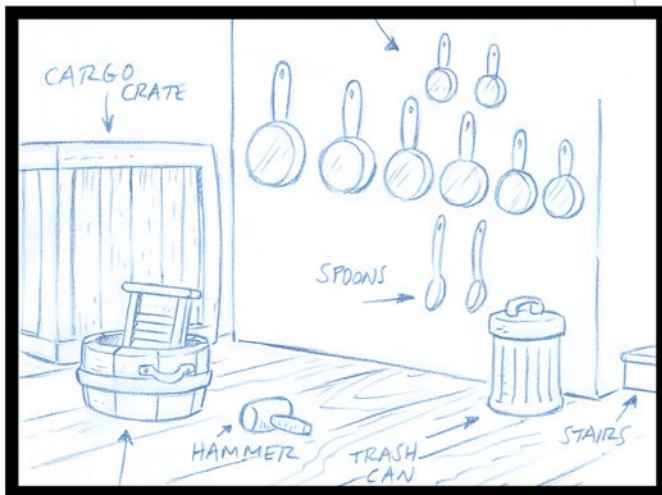

Disney estaba convencido de que el sonido aportaría una auténtica sensación de magia y humor a los dibujos animados, y vaya que así fue. Su sentido de la narración y su afán por la innovación técnica se impusieron e hicieron mundialmente famosos tanto a Walt Disney como a Mickey Mouse. 90 años después, The Walt Disney Company sigue a la vanguardia internacional de la narración de historias y la innovación en el campo de la animación.

Nos enorgullece presentar este modelo y esperamos que aporte un poco de esa sensación de magia que sembró *El Barco De Vapor Willie* cuando se proyectó por primera vez.

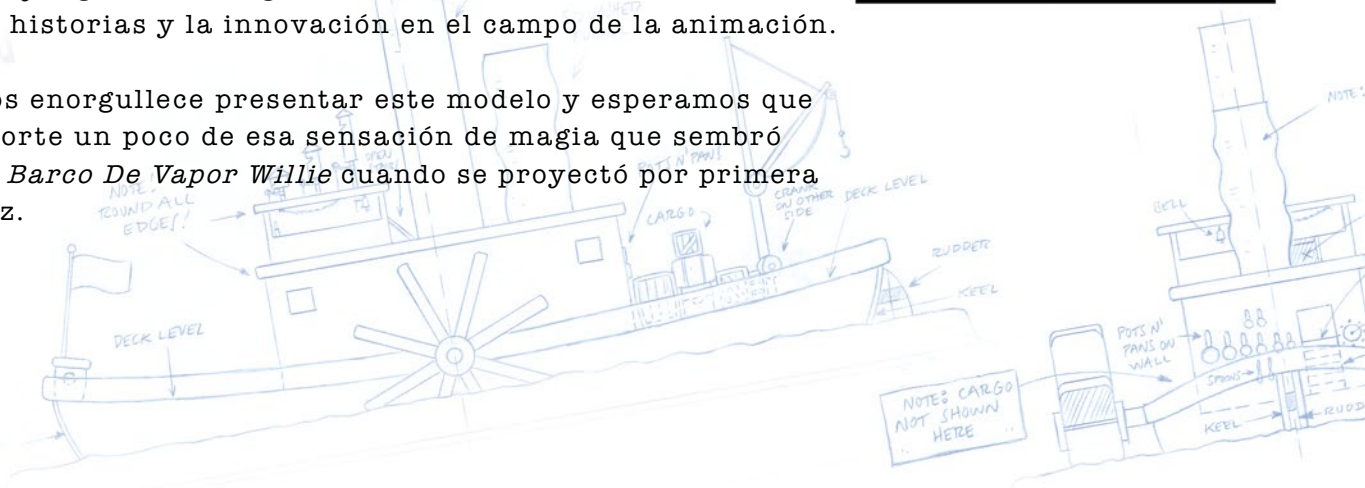

Los favoritos de Máté

Set LEGO®:

Main Street (6765), porque ofrece muchas posibilidades de juego y contiene un montón de sorpresas ocultas.

Elemento:

La placa redonda con espiga abierta LEGO 1x1 (85861) es muy útil, porque permite unir ejes, placas y bricks de otros tipos.

Diseñador de LEGO:

Michael Fuller, Jordan David Scott y Chris Stamp, los diseñadores de la Vaca Marina de Barba Metálica.

Fan diseñador/diseñador de la comunidad:

Entre otros, Kevin Szeto, creador del Submarino Amarillo LEGO Ideas inspirado en los Beatles.

Conoce a los diseñadores



Máté Szabó, fan diseñador, Budapest (Hungría)

Máté trabaja como animador profesional; le encanta grabar y editar videos y, por supuesto, construir con LEGO®. Visita su cuenta de Instagram: @szabolego.

“Me encantaba jugar con mis bricks LEGO cuando era pequeño y todavía me fascina cómo funciona el sistema. Me enseña muchísimo sobre cómo pensar en contextos más amplios.

Para mí, los personajes, las caricaturas y las películas de Disney son una fuente de inspiración. Quería rendir homenaje a los brillantes artistas que crearon esas obras maestras. Cuando descubrí la minifigura de la versión clásica de Mickey Mouse en la edición Disney de la colección Minifigures, me puse a pensar en *El Barco De Vapor Willie*.

Durante la creación del modelo, volví a ver el corto tantas veces como pude y busqué planos para lograr la máxima precisión. Pero también tuve que reducir el número de elementos y simplificarlo un poco. Lo más difícil fue recrear el casco del barco, que traté de hacer lo más redondo posible. Dedicué alrededor de 3 meses a completar el modelo, trabajando en él un par de horas al día.

Fue un extraordinario honor alcanzar la cifra mágica de los 10.000 votos. La parte más difícil vino después de superar la marca de los 5.000. Fue un verdadero esfuerzo porque sólo quedaban 44 días para la fecha límite. Quiero dar las gracias de corazón a todos los que participaron.

Para los miembros de la comunidad de LEGO Ideas, mi consejo es que sean ellos mismos y creen algo que les interese y les apasione. Esa es la clave”.





John Ho, diseñador de LEGO®

“Vi *El Barco De Vapor Willie* cuando estaba en la universidad y me sorprendió que fuera la primera historieta animada de Disney con sonido sincronizado y la primera aparición de Mickey Mouse en la pantalla. Espero que todo el que construya este modelo experimente también ese momento de admiración y asombro.

Mi trabajo consistió en transformar la extraordinaria propuesta LEGO® Ideas del fan en un magnífico producto LEGO cuyo flujo de construcción resultara agradable y que ofreciera detalles exclusivos, así como una experiencia de juego divertida. Numerosos detalles del original están representados con creatividad en el modelo. El desafío era incorporar funciones sin dar la espalda a esos fabulosos detalles. ¡Es muy divertido empujarlo y ver cómo se mueven las ruedas de paletas y las chimeas!



El Barco De Vapor Willie representa un hito de gran importancia en la historia de las obras de animación de Disney; recrear el barco con bricks LEGO fue un honor que convirtió cada jornada de trabajo en un día único y especial”.

Crystal Bam Fontan, diseñadora gráfica de LEGO®

“*El Barco De Vapor Willie* es un clásico de todos los tiempos y Mickey será siempre uno de los personajes favoritos de los fans, ¡así que formar parte del desarrollo de este set fue un gran honor!

Como diseñadora gráfica de LEGO®, mi trabajo consistió en hacer realidad los sueños del fan diseñador en la medida en que podía hacerlo mediante elementos gráficos. Máté Szabó logró incorporar un montón de detalles en su propuesta.

El set incluye a Minnie y diversos elementos decorados. Lo más complicado fue hacer que destacaran las minifiguras de Mickey y Minnie, pues son ellos los protagonistas. ¡Decidí agregar un poco de dinamismo extra con detalles plateados en sus accesorios y en el propio barco de vapor para que el set llamara más la atención! Si quieren saber un secreto divertido, la cabra del corto forma parte del elemento decorado que representa la partitura”.

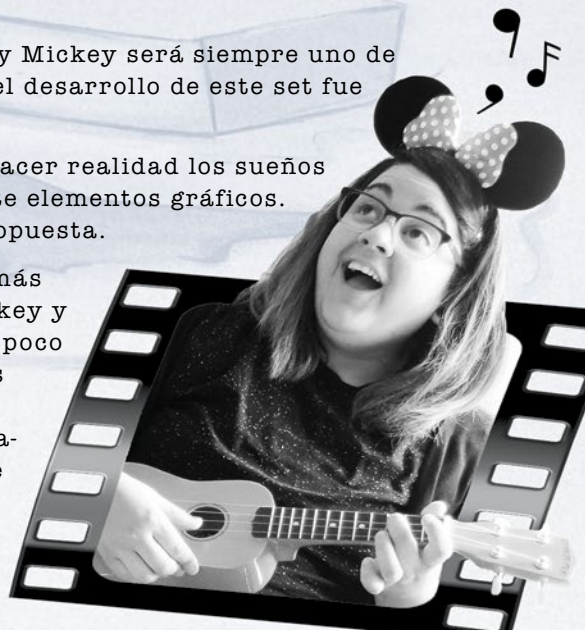

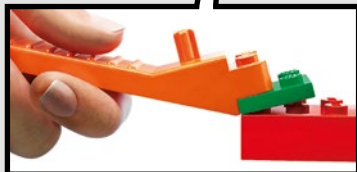
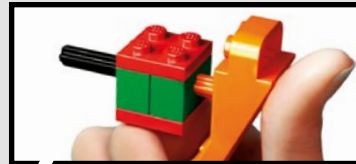
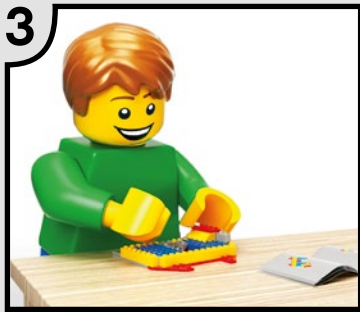

LEGO.com/brickseparator

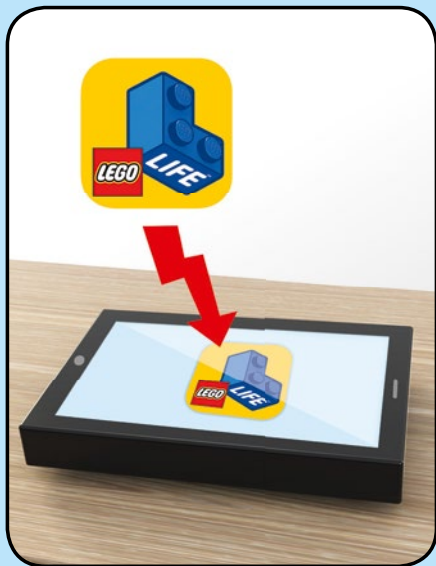

- 1** Download the LEGO® Life App
Lade dir die LEGO® Life App
herunter
Télécharge l'application LEGO® Life
Télécharger l'application LEGO® Life
Scarica l'app LEGO® Life
Descarga la app LEGO® Life
Descarrega a App LEGO® Life
Töltsd le a LEGO® Life Appot!
Lejupielādē lietotni LEGO® Life
下載 LEGO® Life 应用程序



- 2** Scan the code on the front cover
Scanne den Code auf der Titelseite
Scanne le code sur la page de
couverture
Scanner le code sur la page
couverture
Scansiona il codice sulla copertina
Escanea el código de la portada
Faz scan do código na frente da capa
Olvasd be a borítón látható kódot!
Noskenē kodu uz priekšējā vāka
扫描封面上的二维码

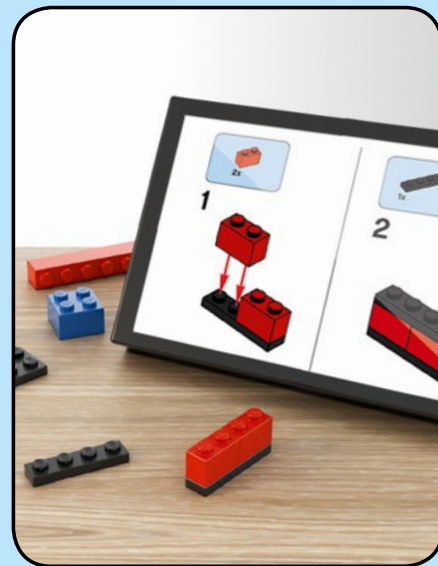

- 3** Get the Building Instructions
Hol dir die Bauanleitung
Obtiens les instructions de montage
Obtenir les instructions de montage
Scarica le istruzioni per la
costruzione
Consulta las instrucciones de
construcción
Obtém as Instruções de Construção
Szerezd be az építési útmutatókat!
Saņem būvēšanas instrukcijas
获取拼搭说明

LEGO.com/apps

Check for compatibility
Kompatibilität prüfen
Vérifier la compatibilité
Controlla la compatibilità
Comprueba tu compatibilidad

Verificar a compatibilidade
Ellenőrizd a kompatibilitást
Pārbaudīt saderību
检查兼容性

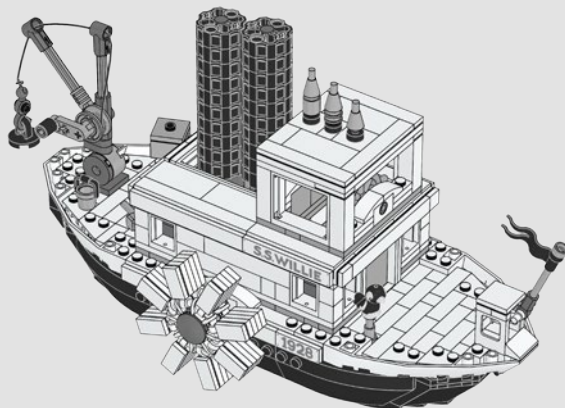
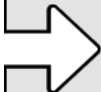
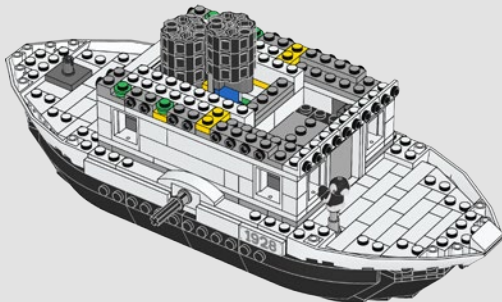
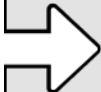
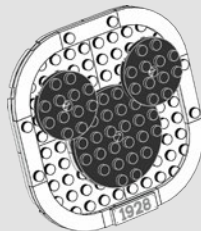
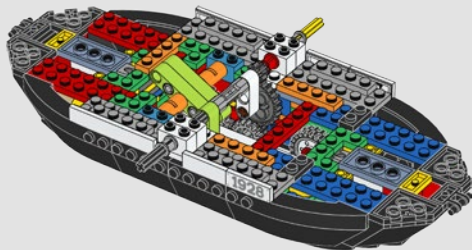
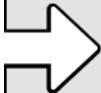

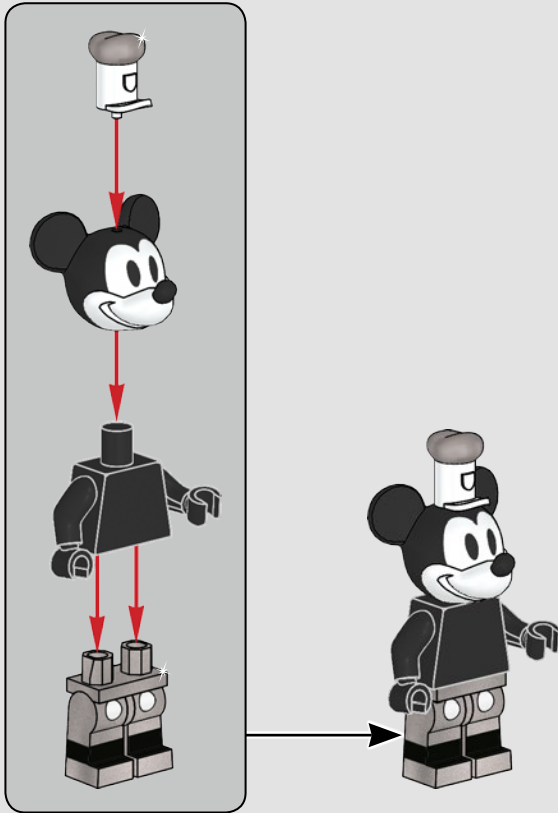
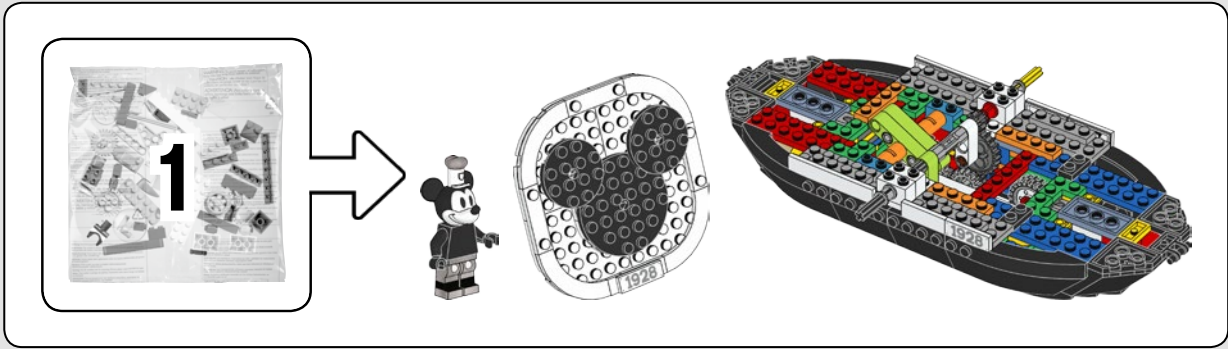

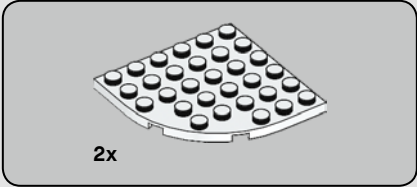
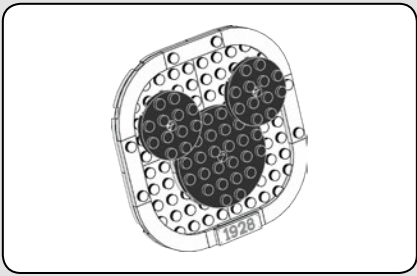

1

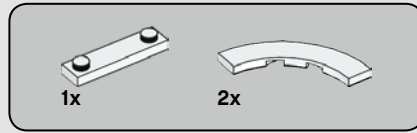
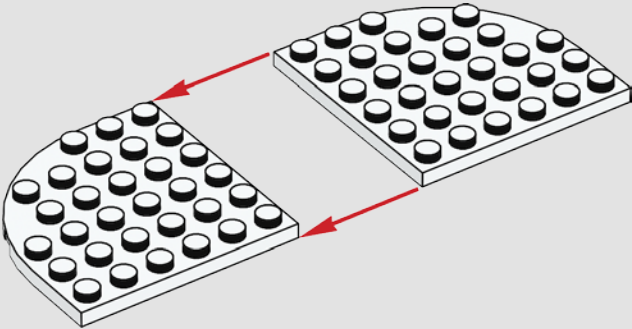

2

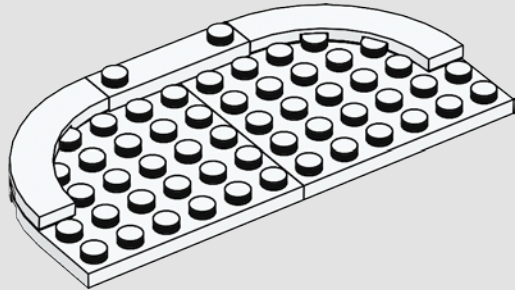

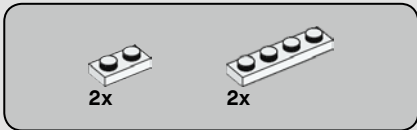

3

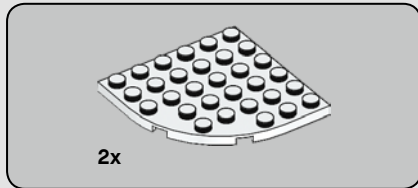
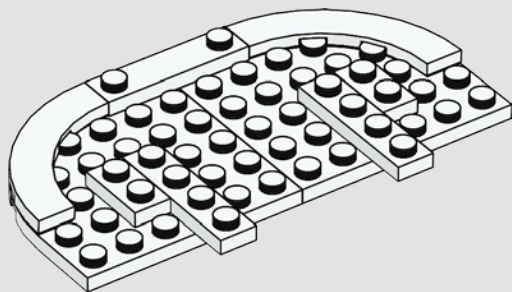

4

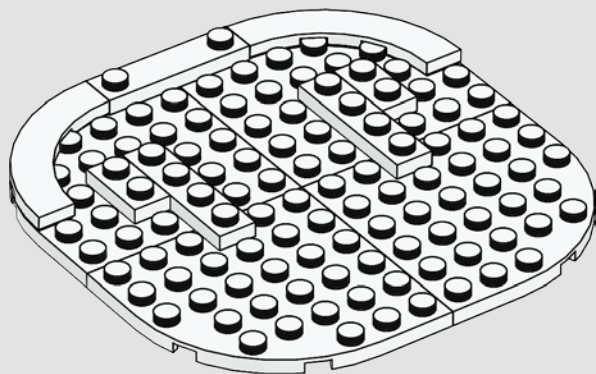

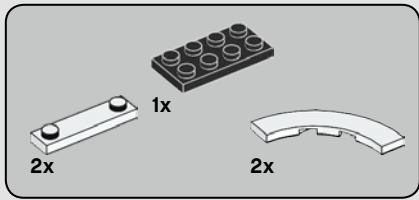

5

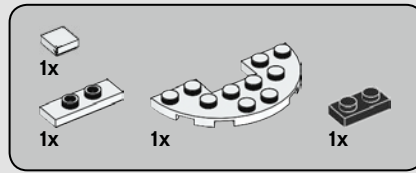
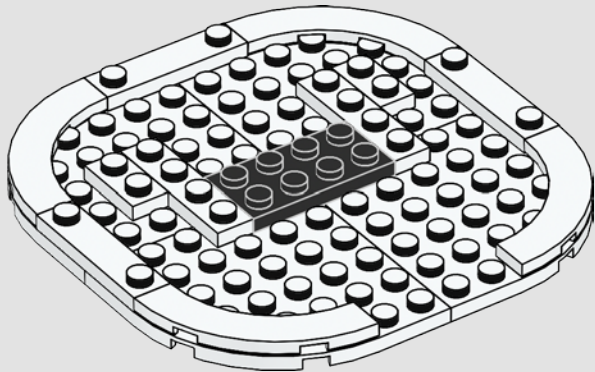

6

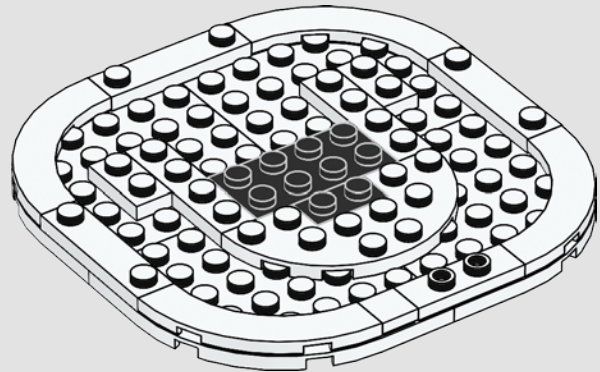

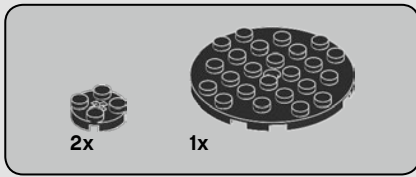

7

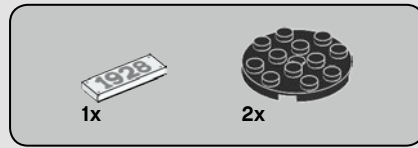
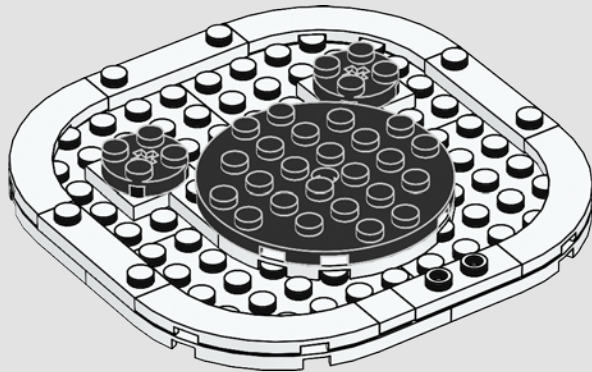

8

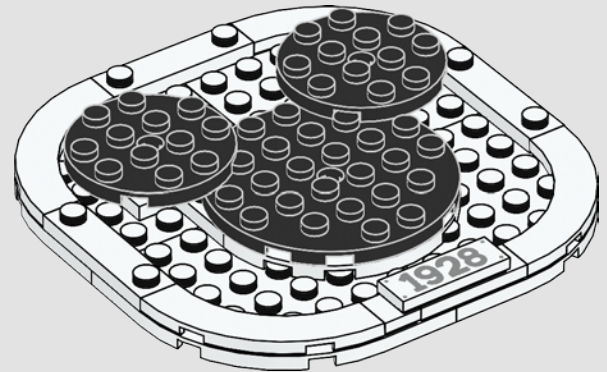

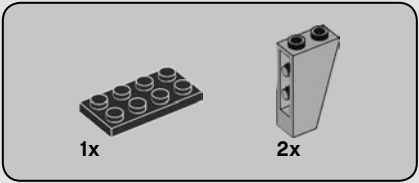

9

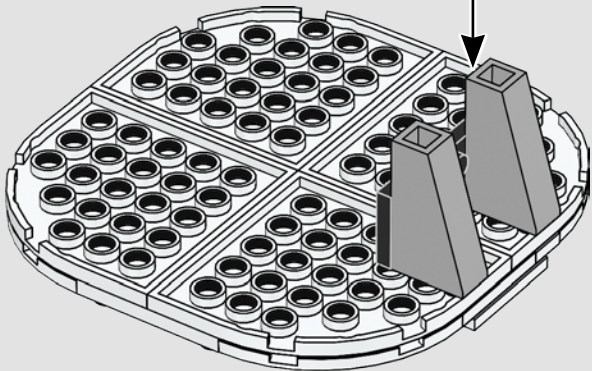
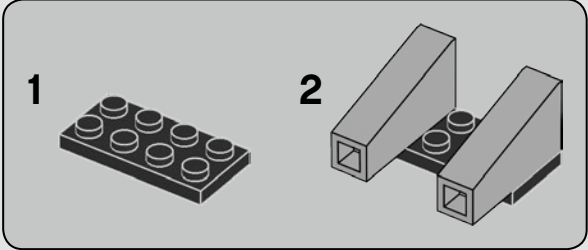

10

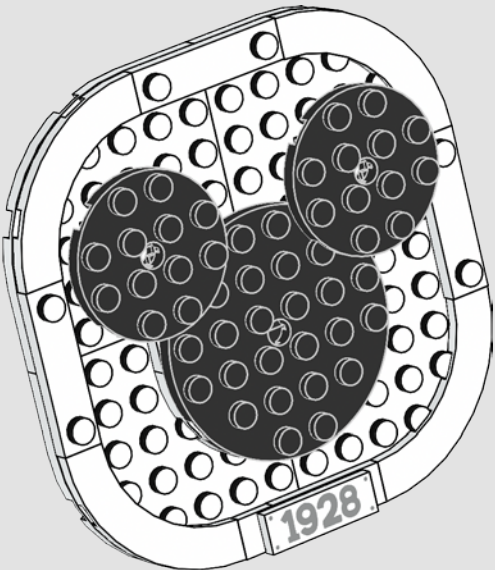

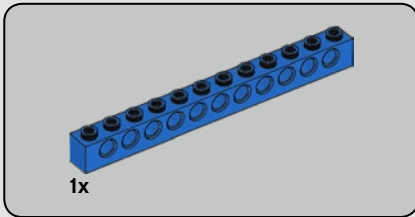
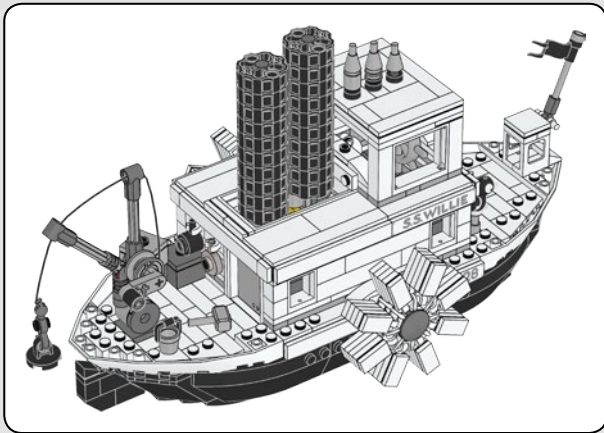

1

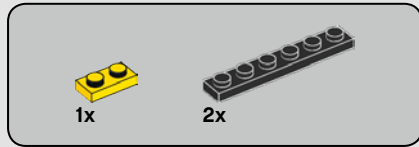
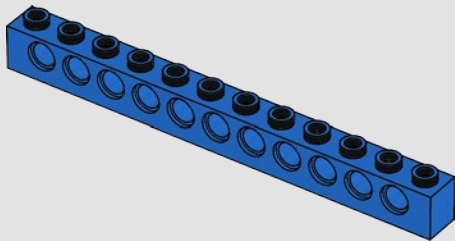

2

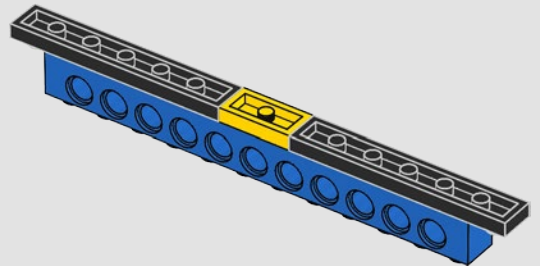
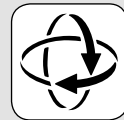

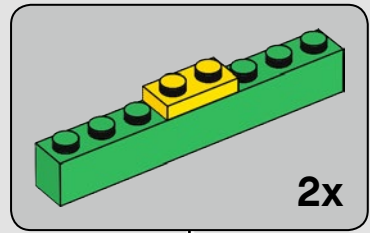
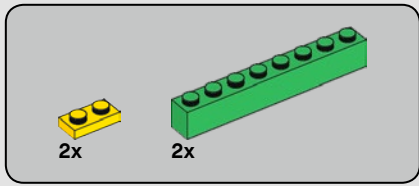

3

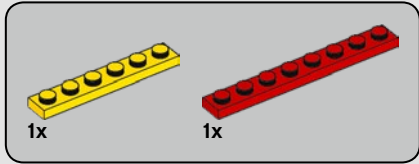
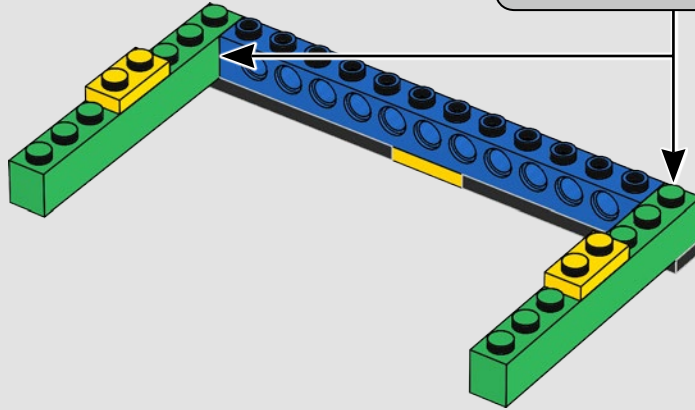

4

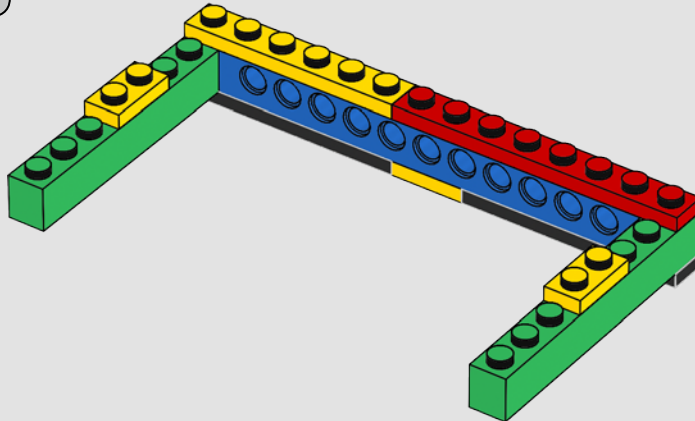

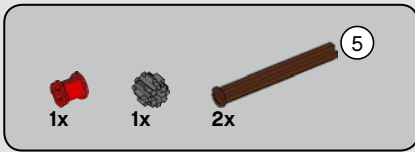

5

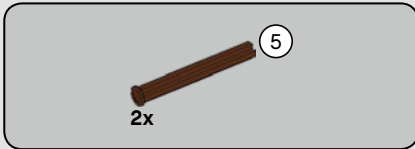
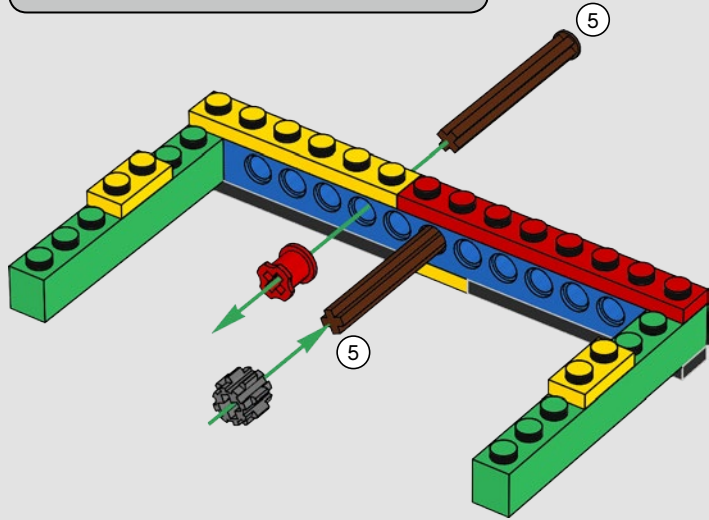
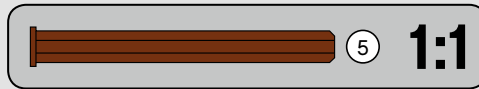

6

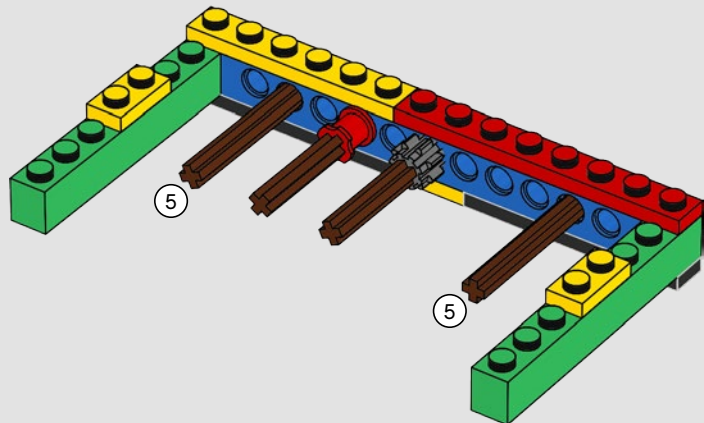

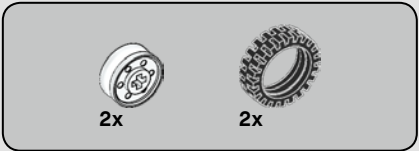

7

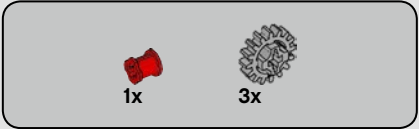
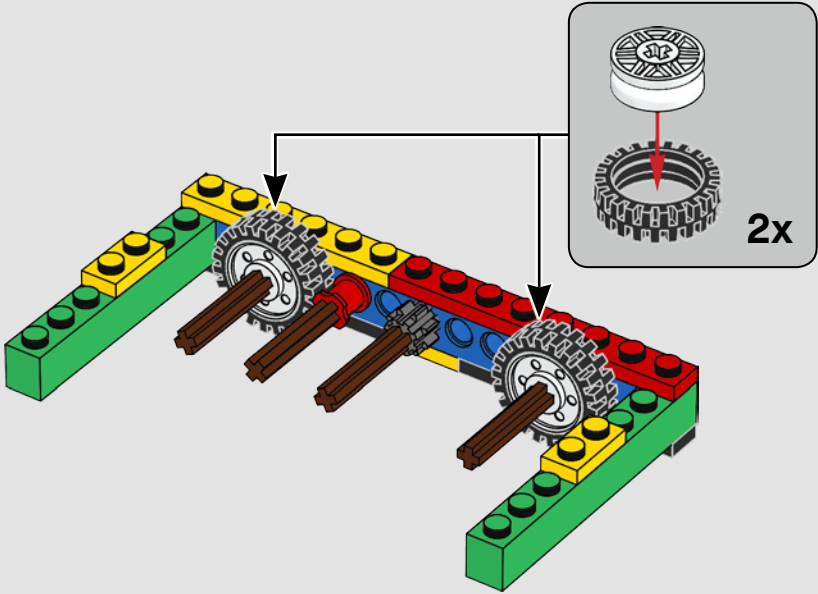

8

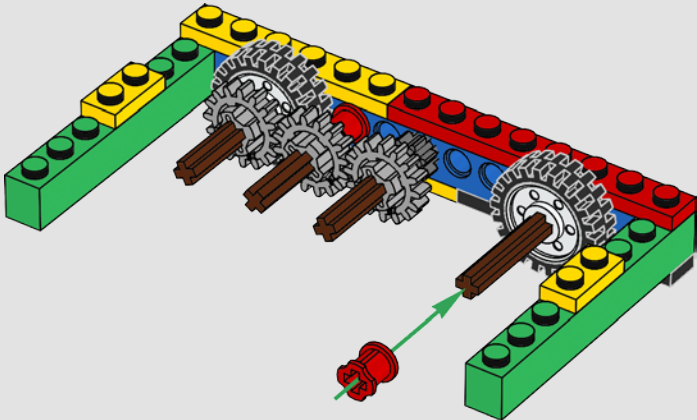

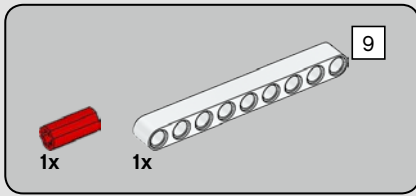

9

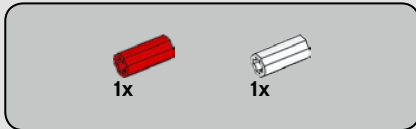
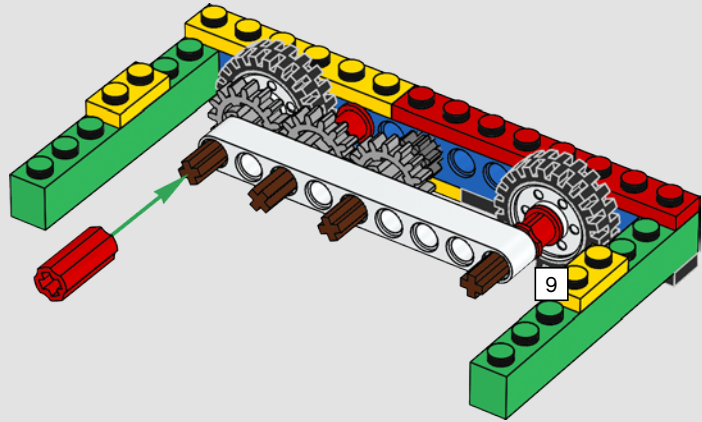
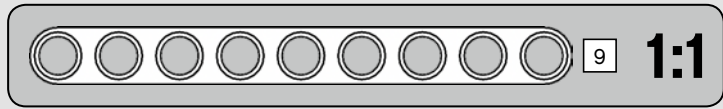

10

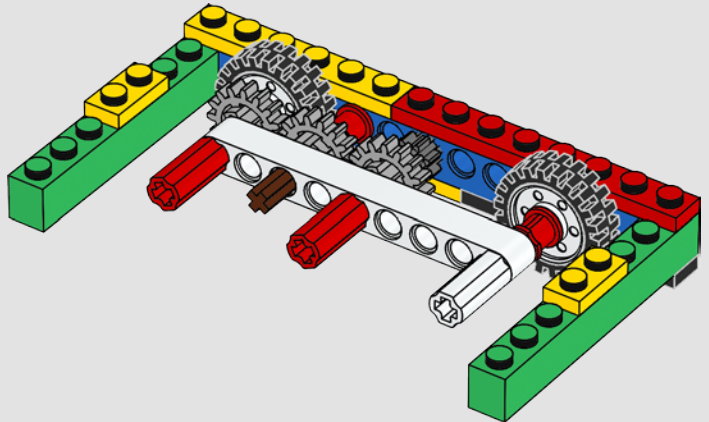

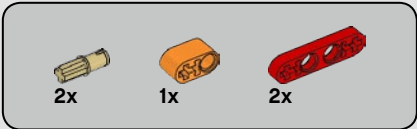

11

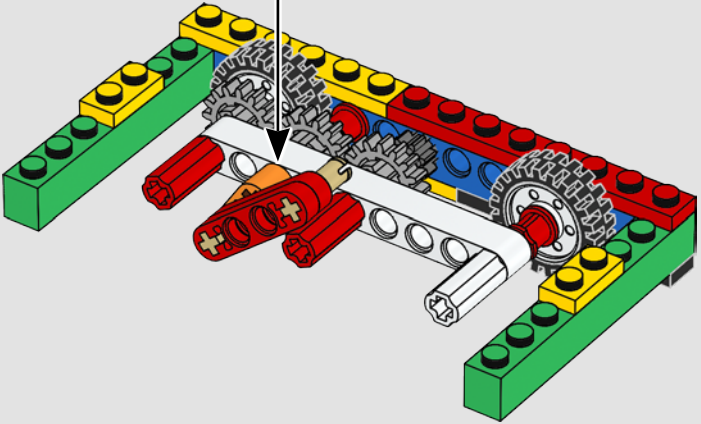
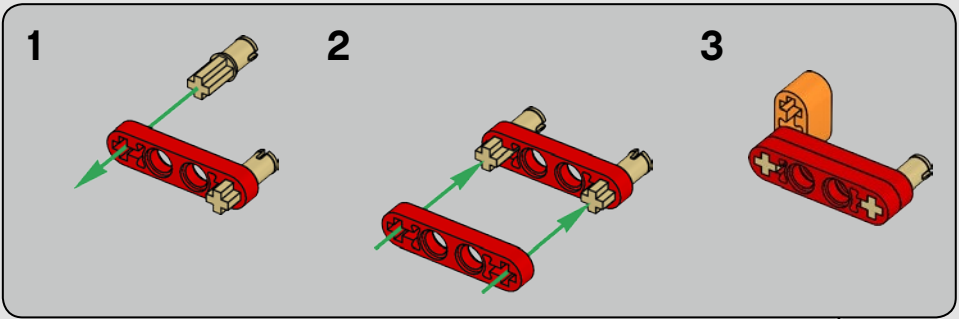

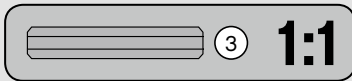
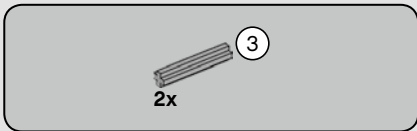

12

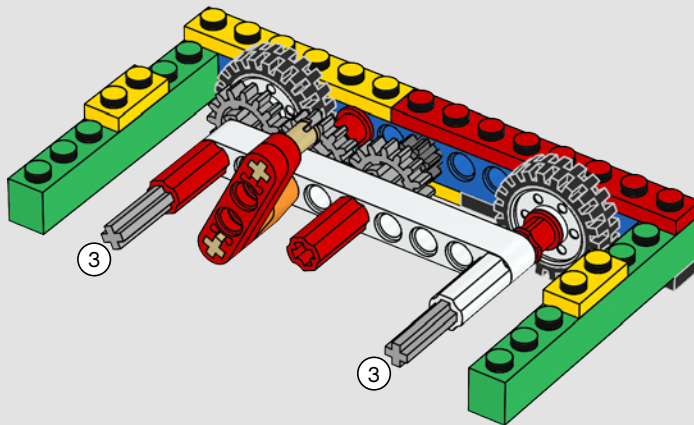

13

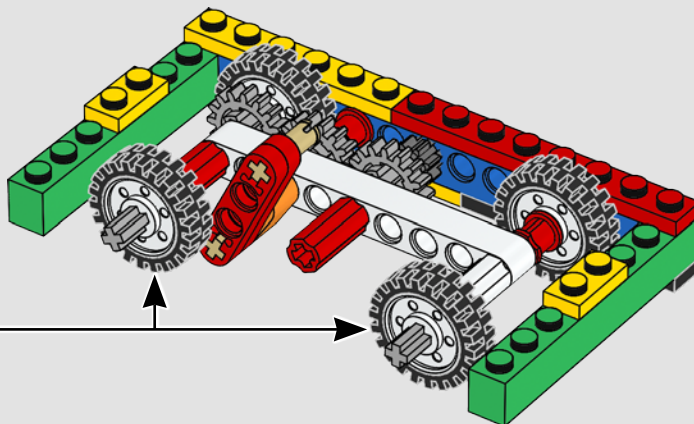
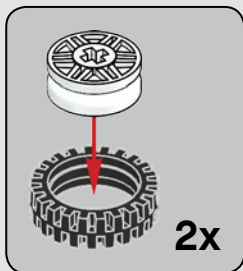

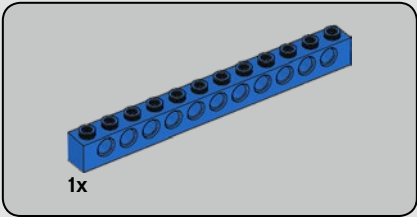

14

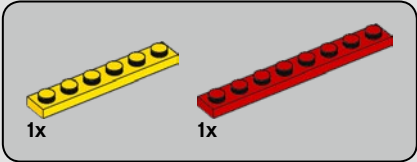
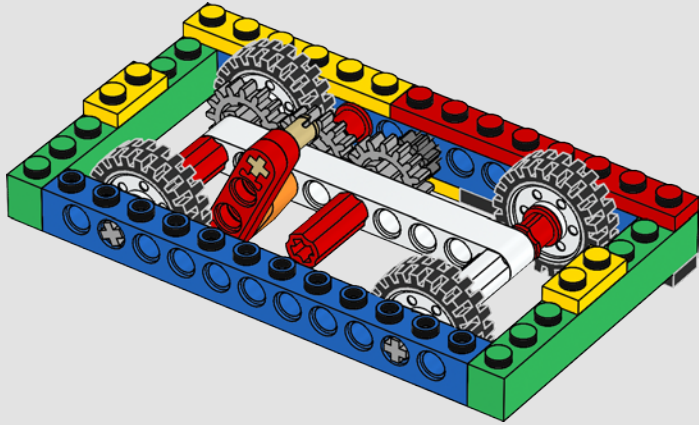

15

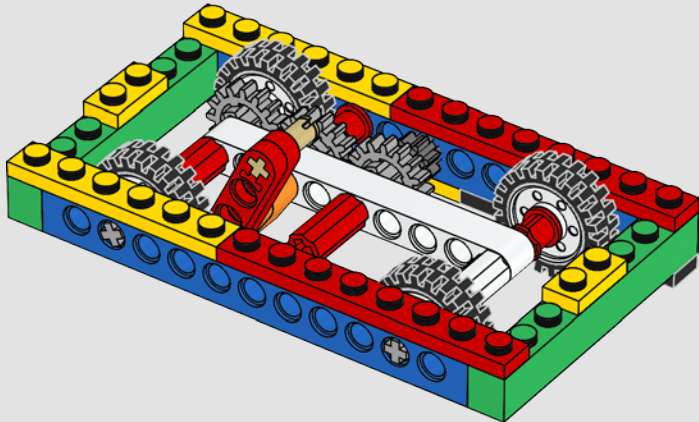

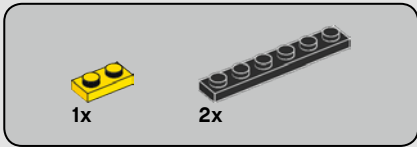

16

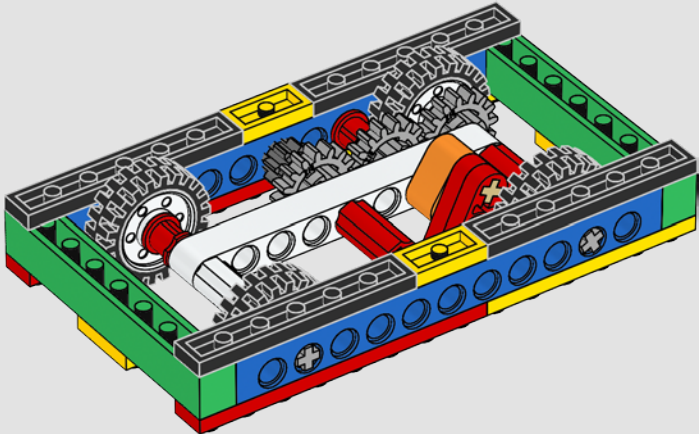

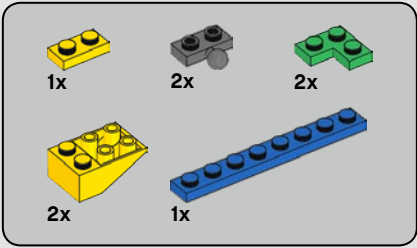

17

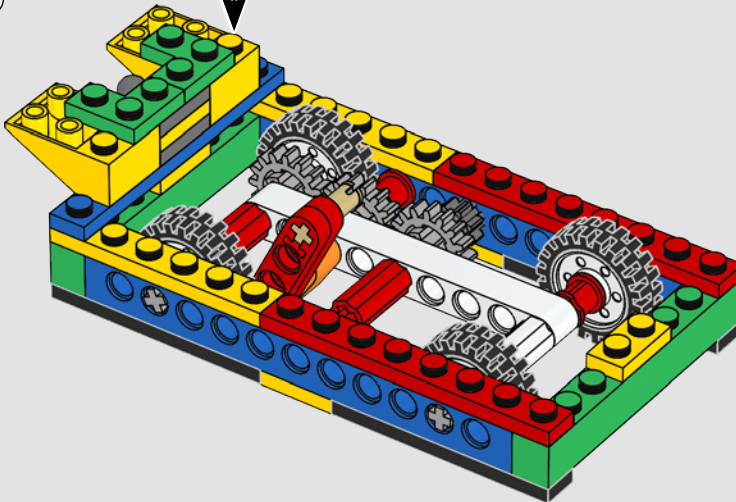
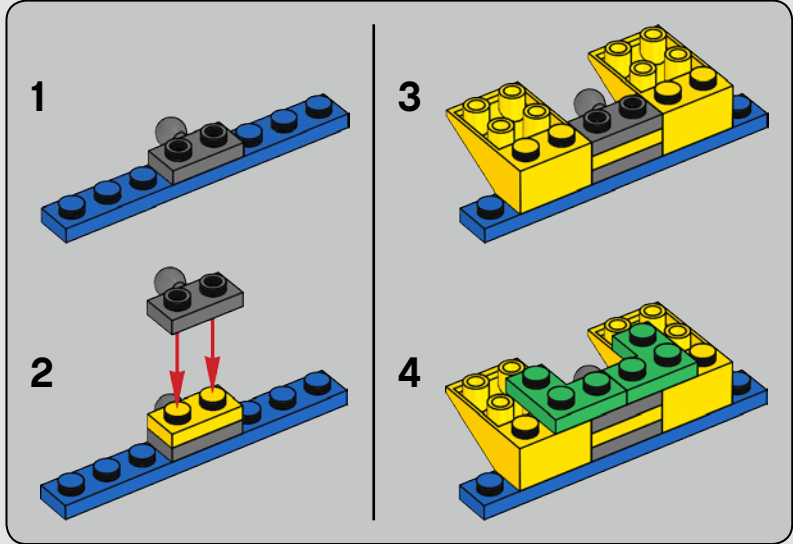

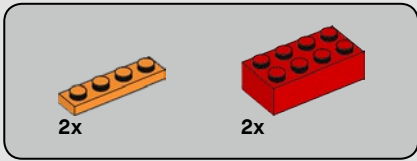

18

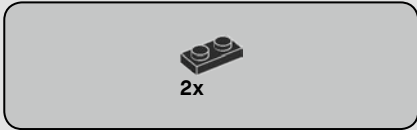
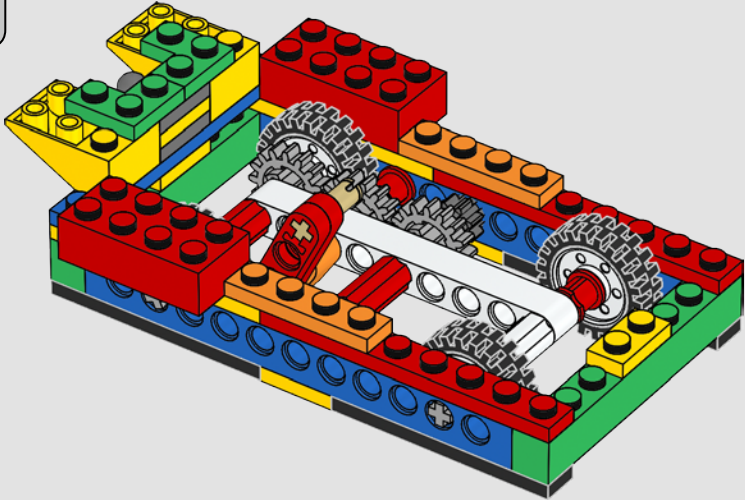

19

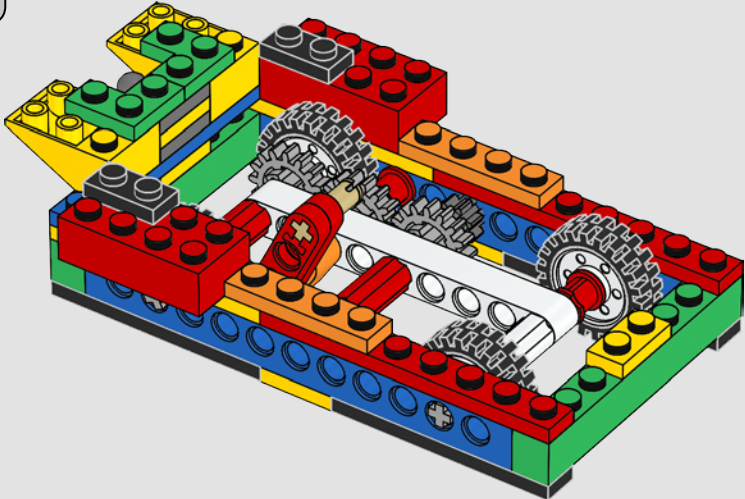

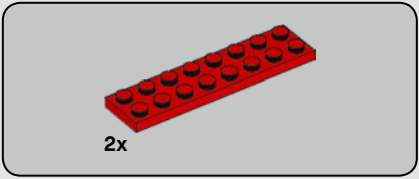

20

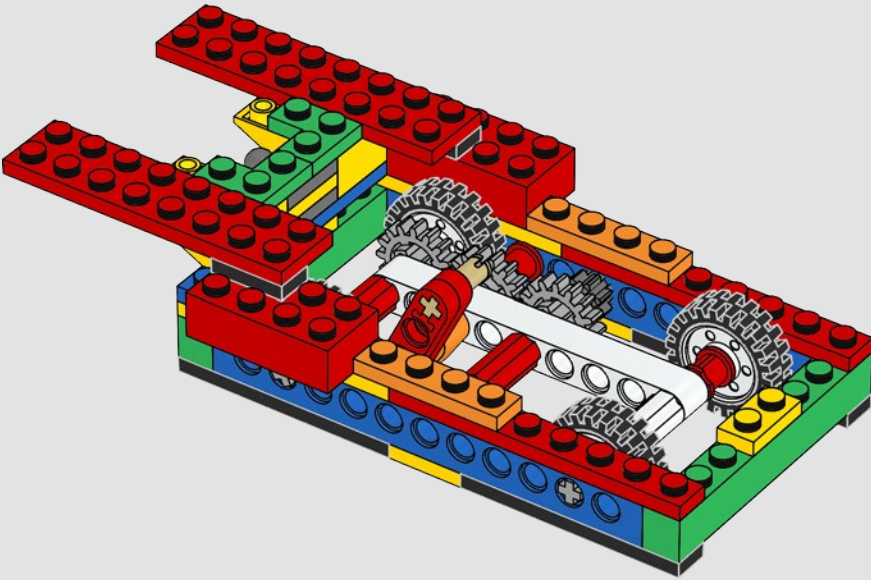

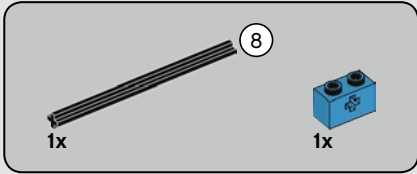
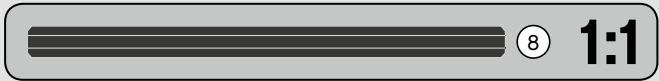
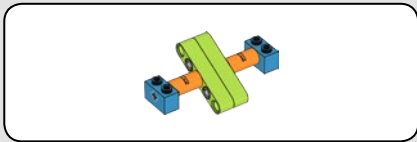

21

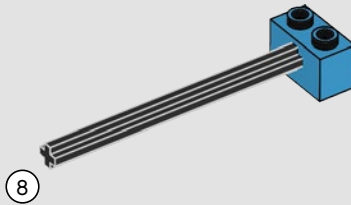

22

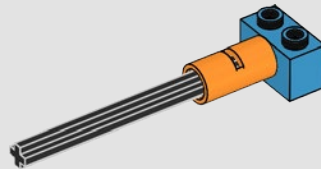

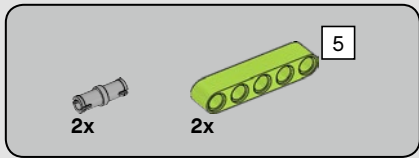

23

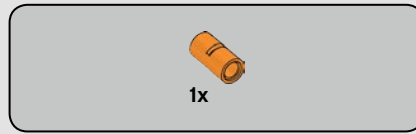
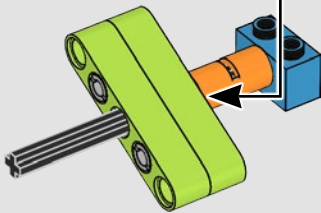
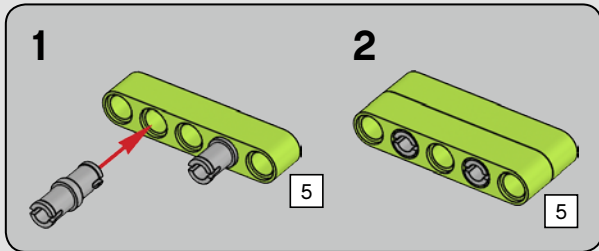
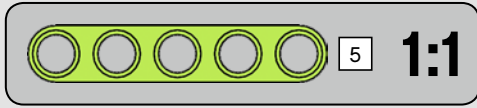

24

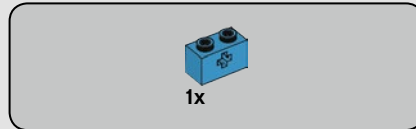
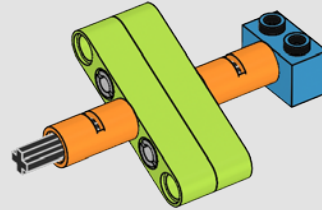

25

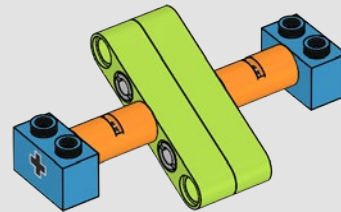

26

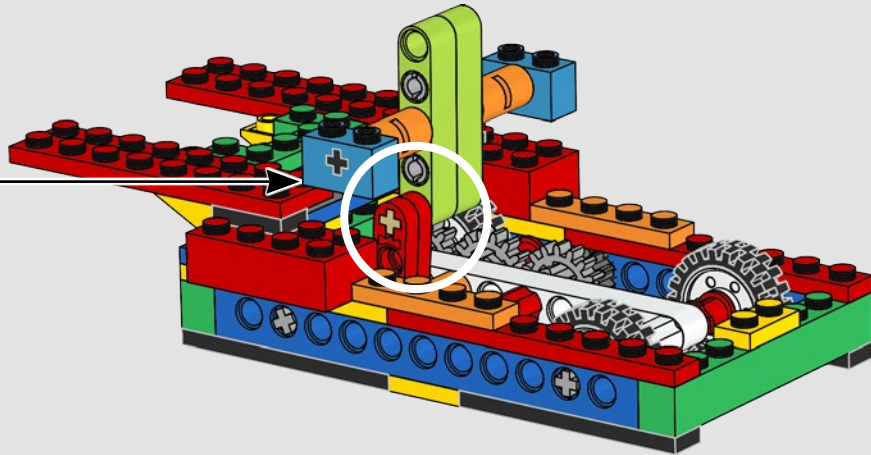

27

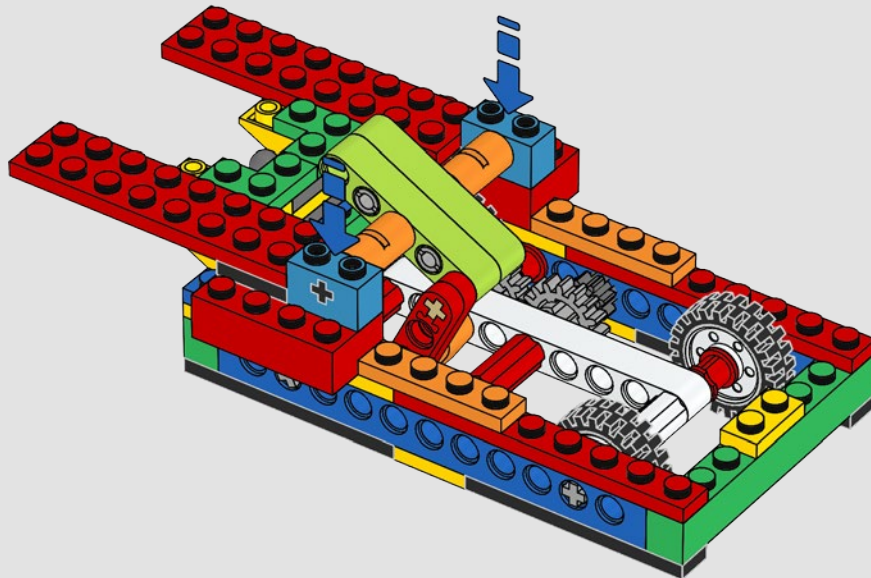

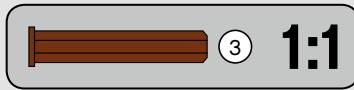
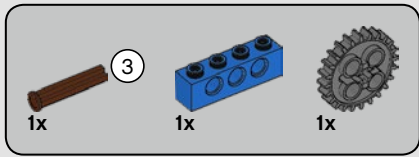

28

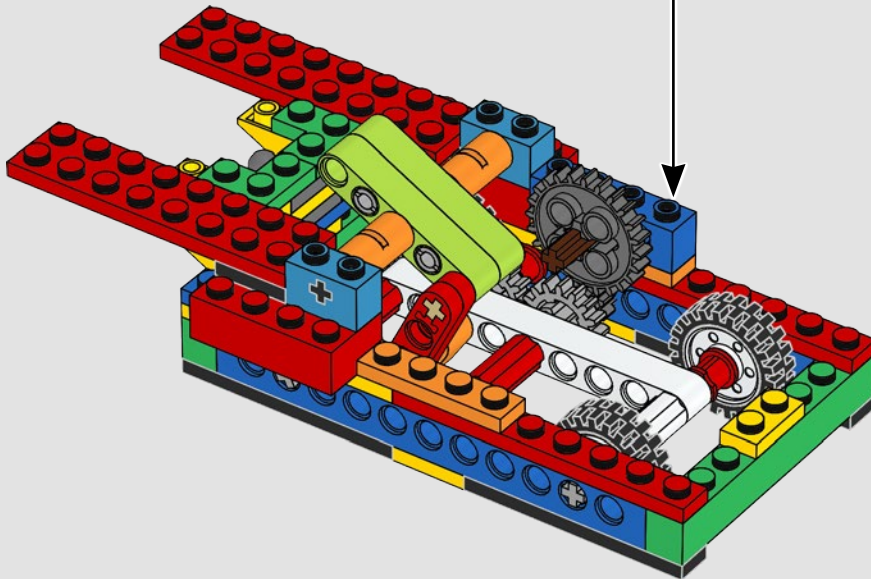
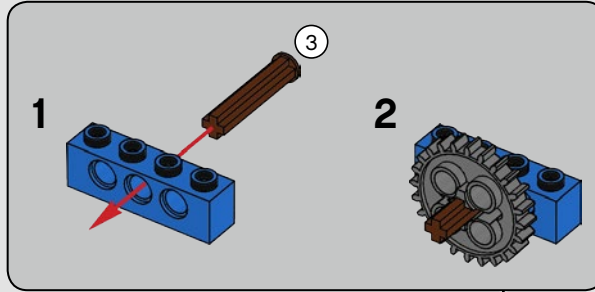

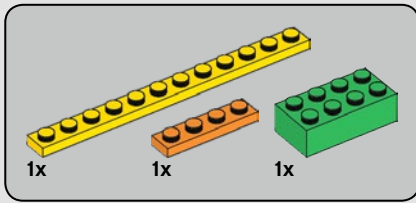

29

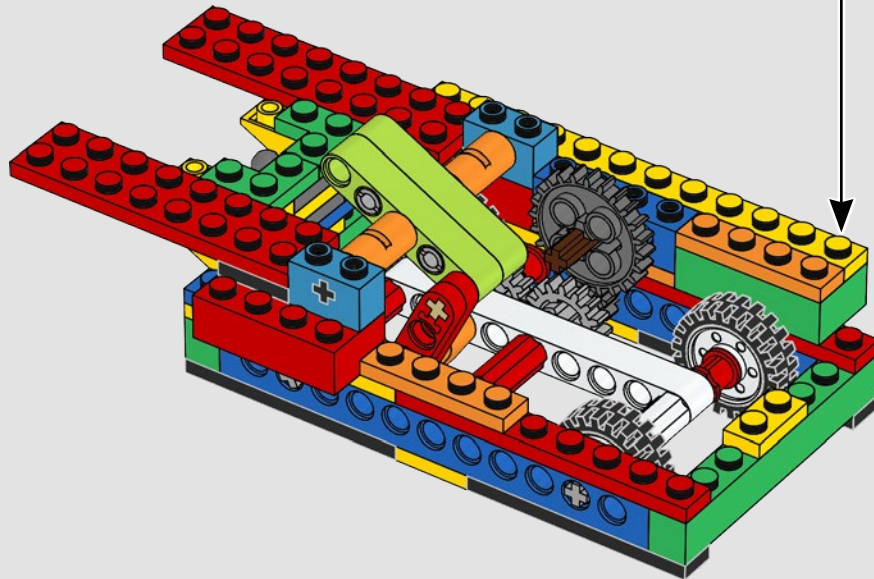
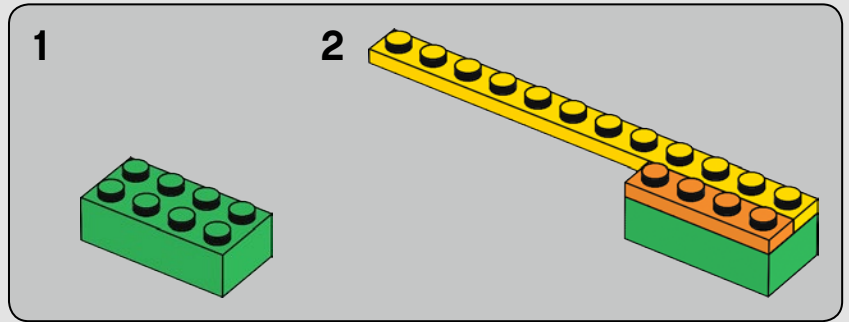

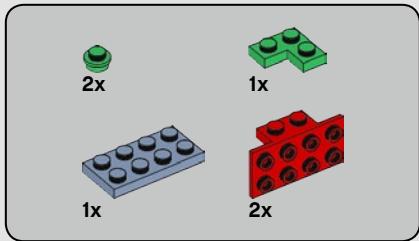

30

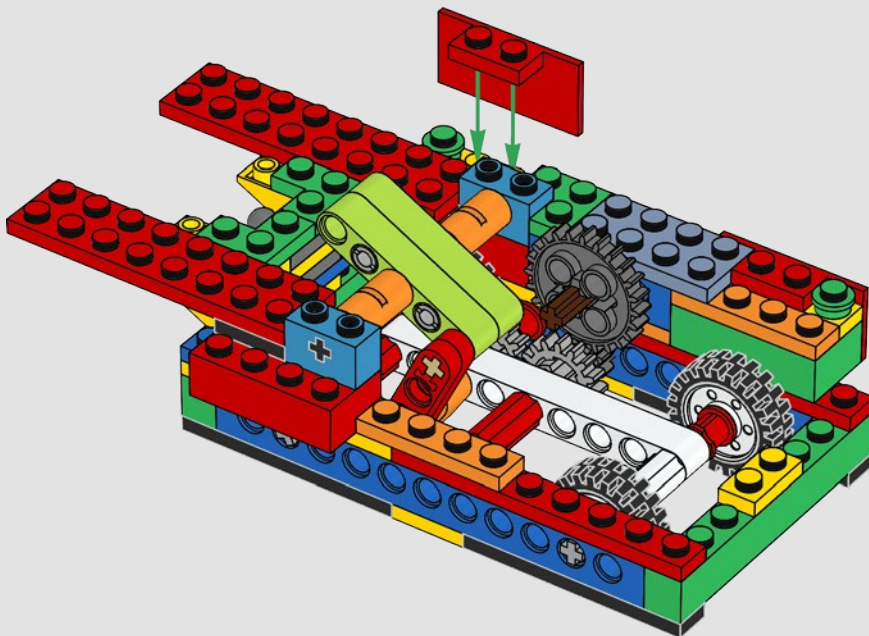

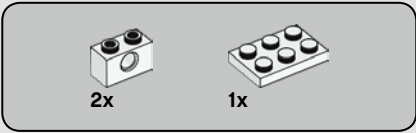

31

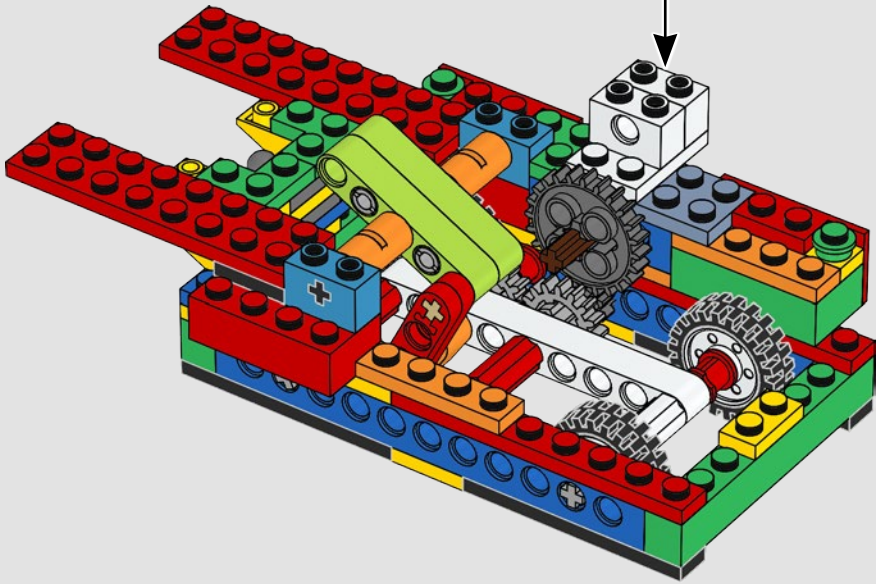
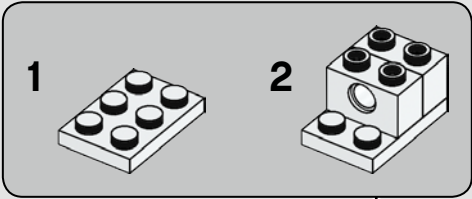

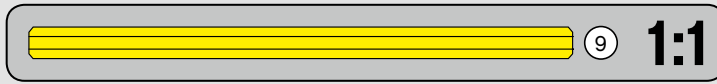
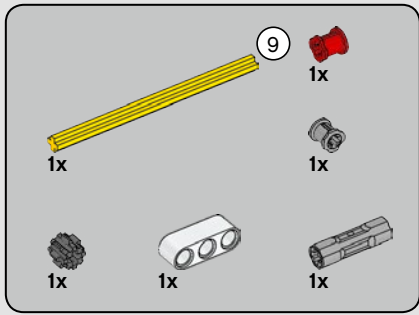

32

1

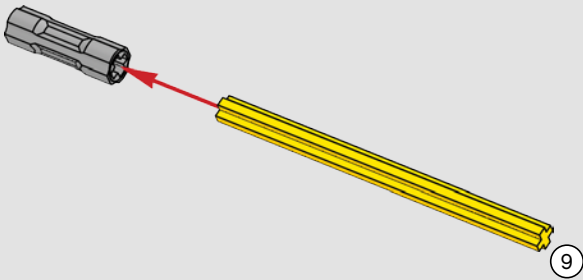

2

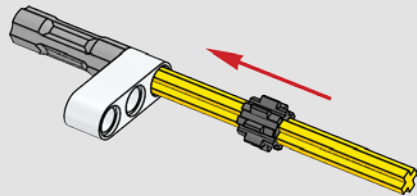

3

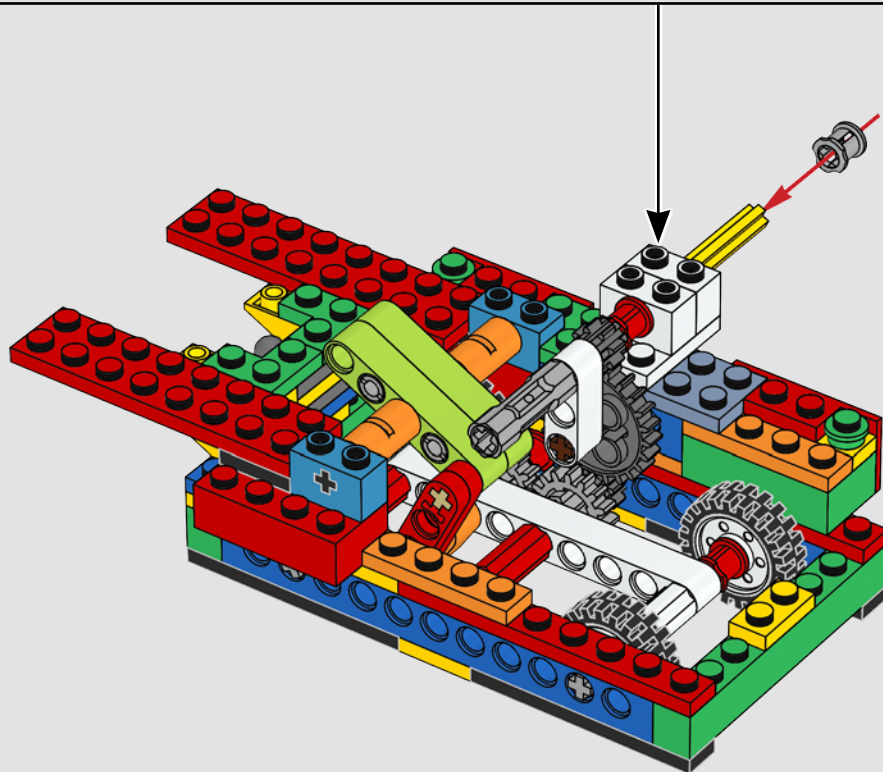
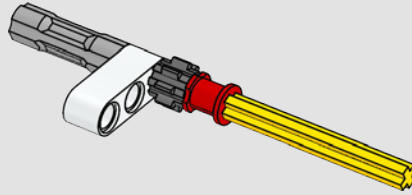

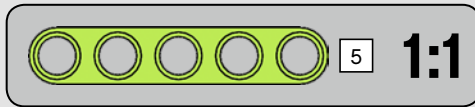
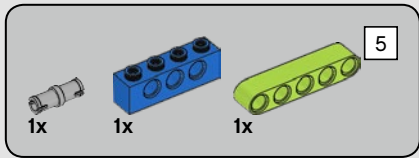

33

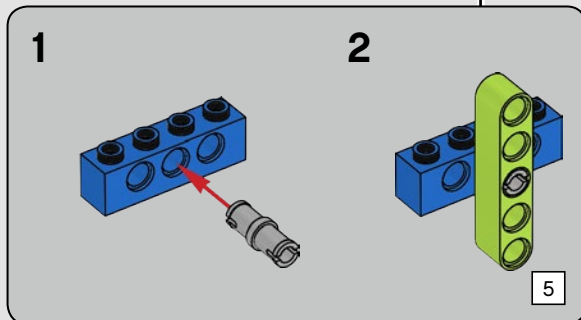
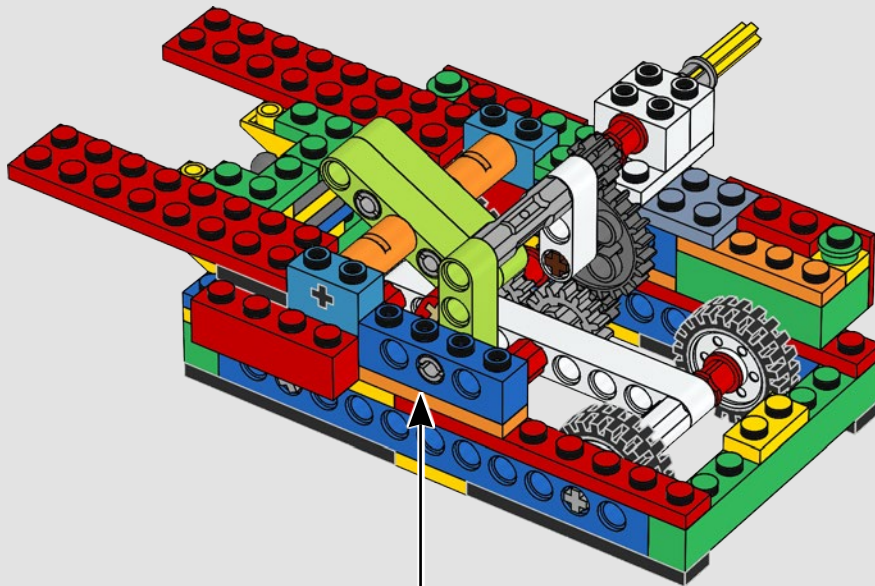

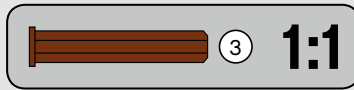
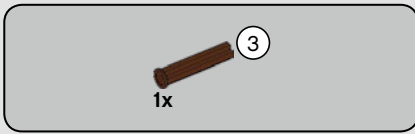

34

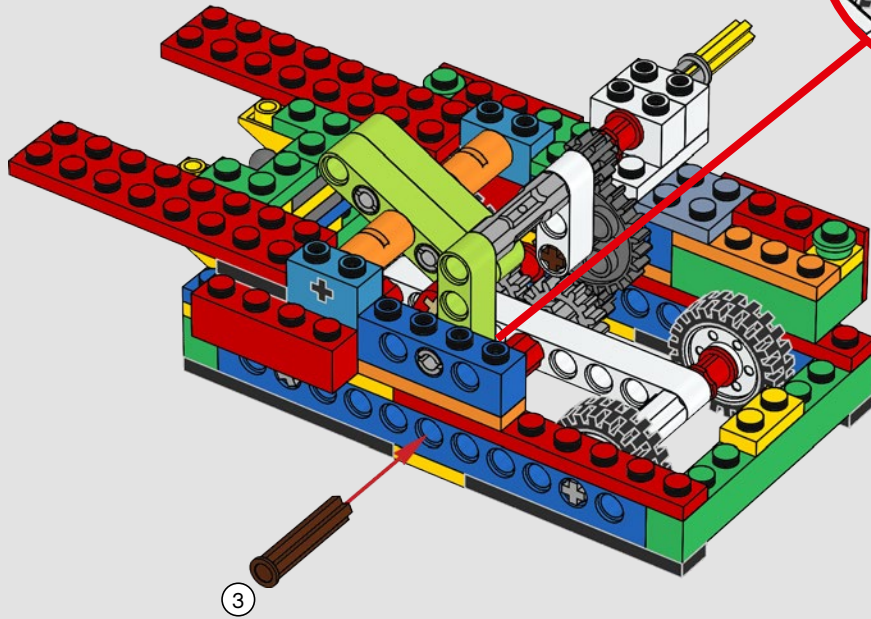

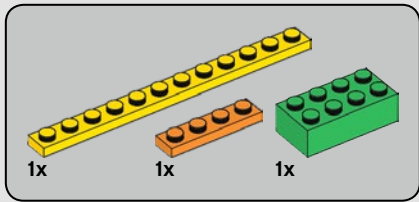

35

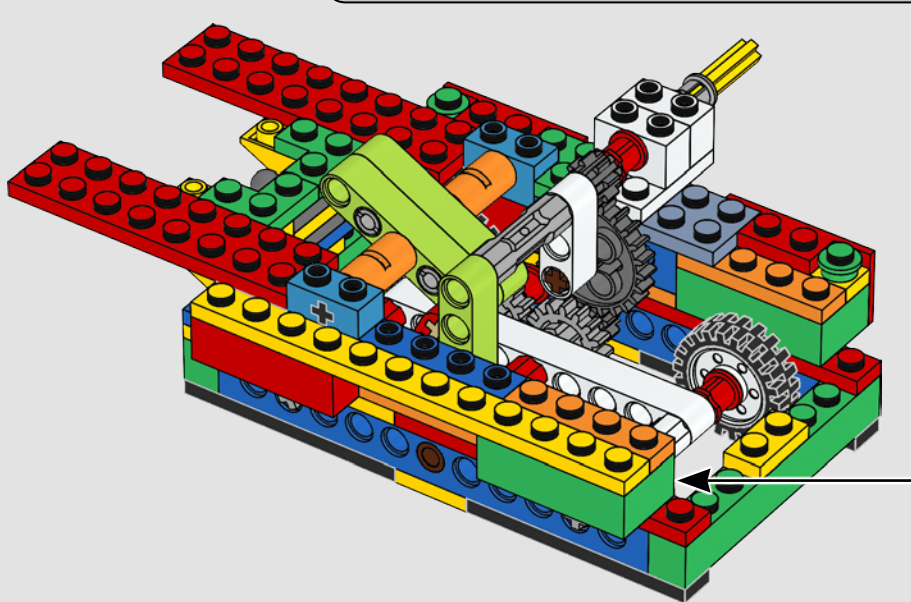
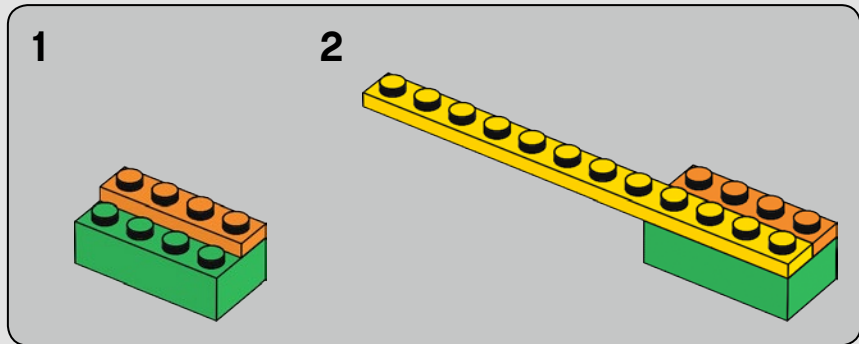

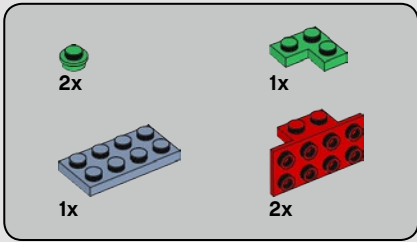

36

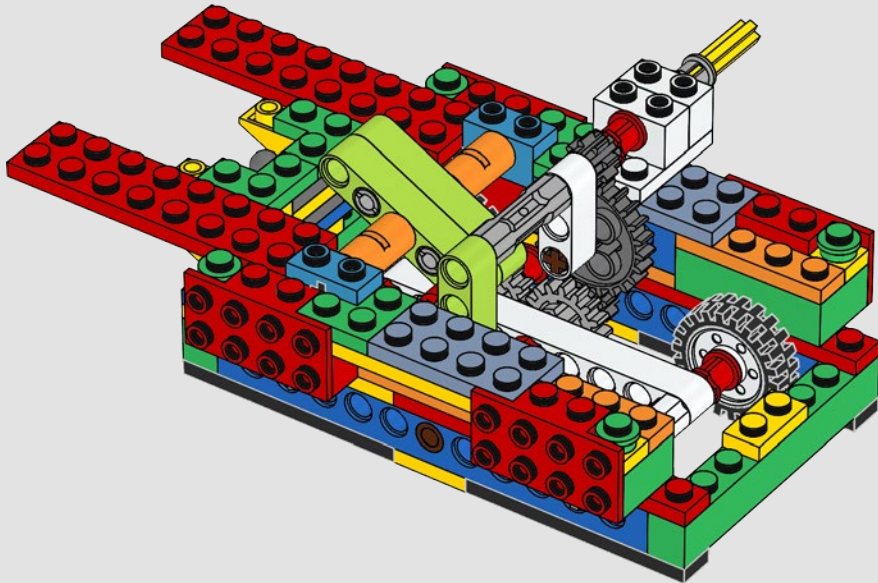



2x



1x

37

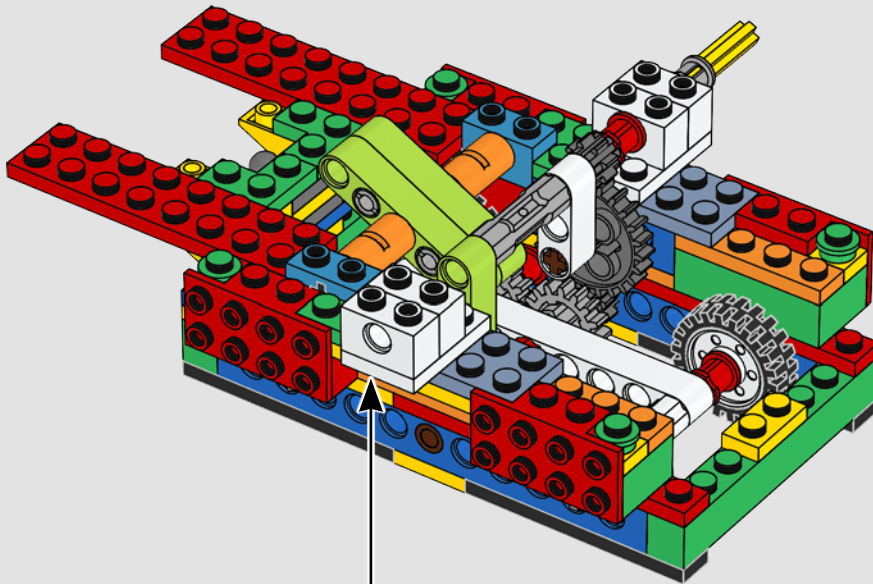

1



2

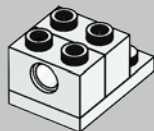

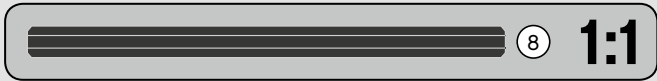
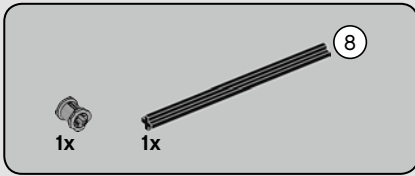

38

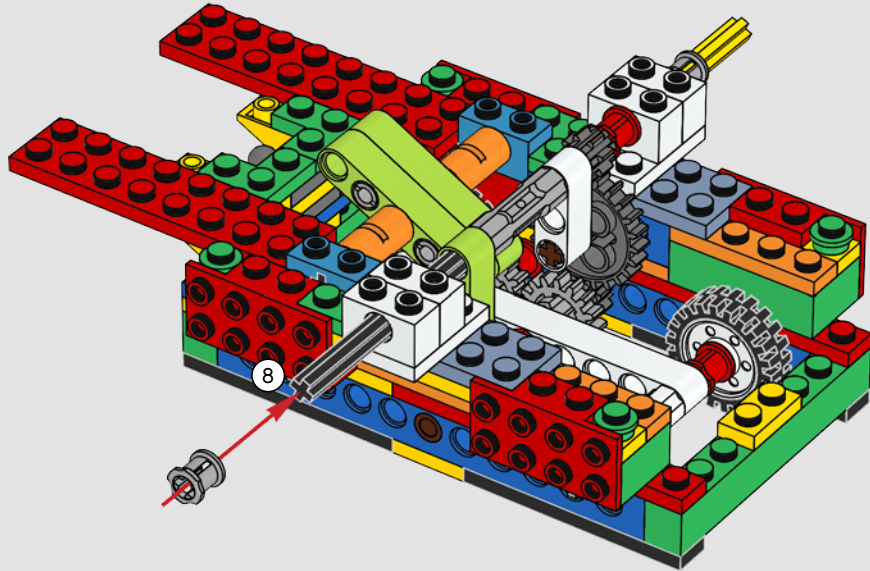

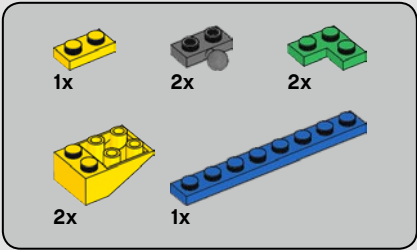

39

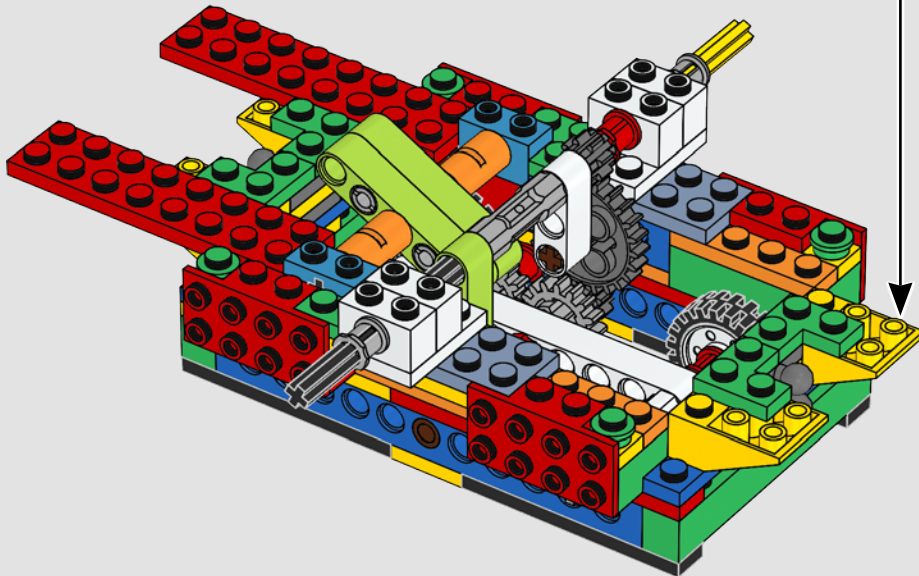
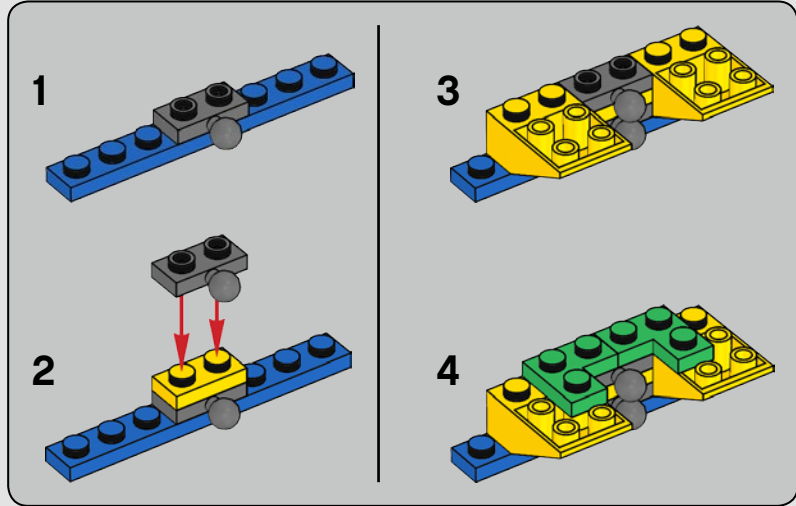

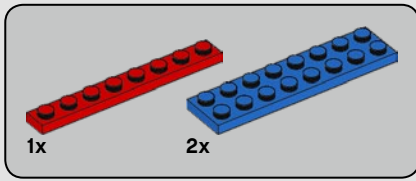

40

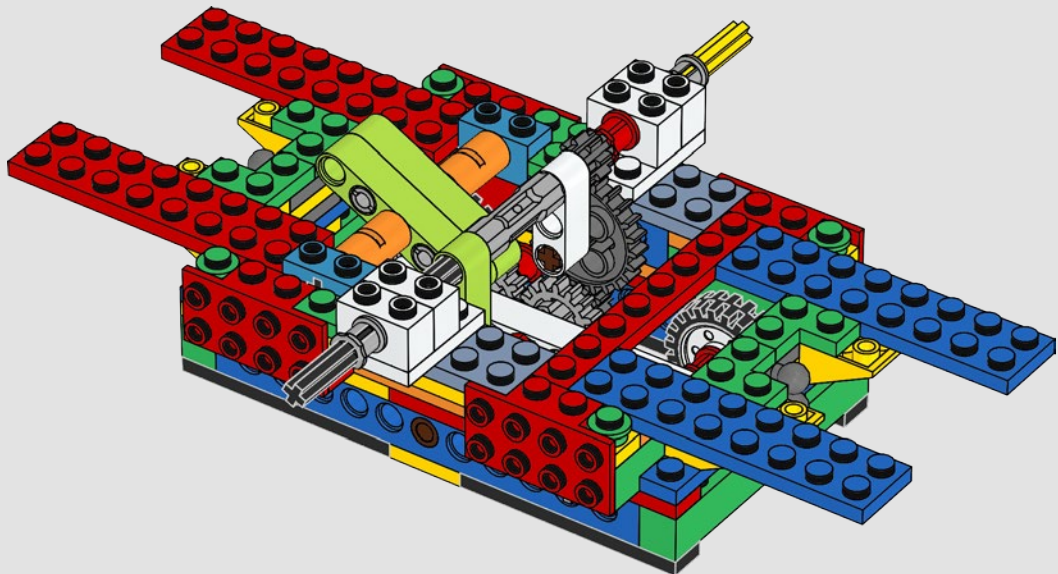

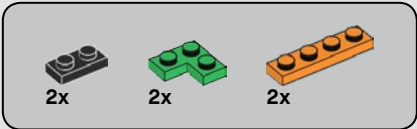

41

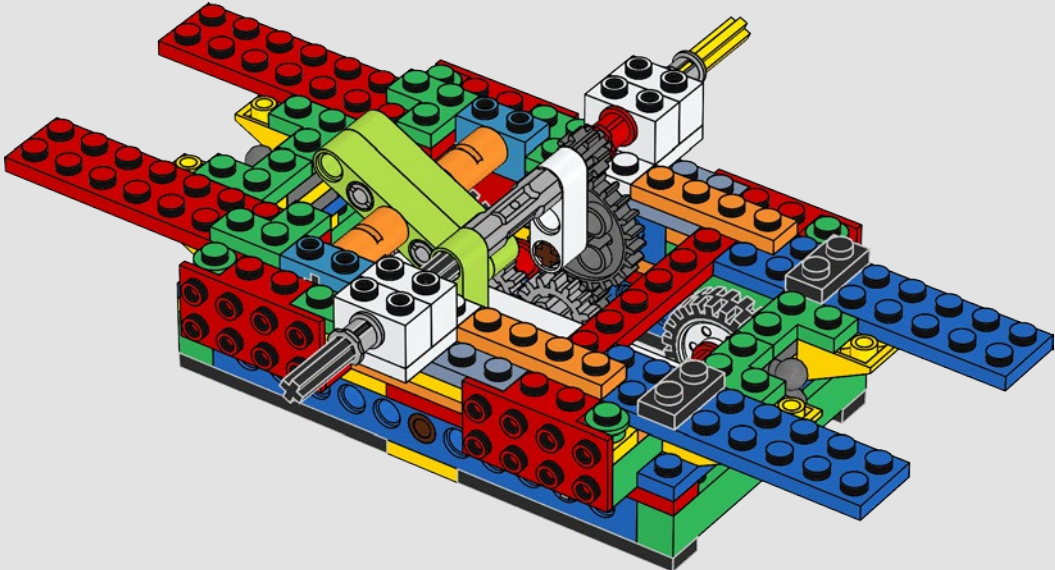

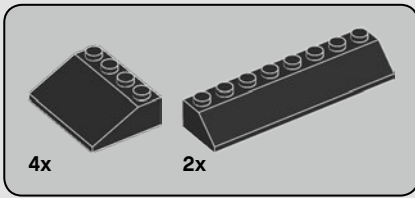

42

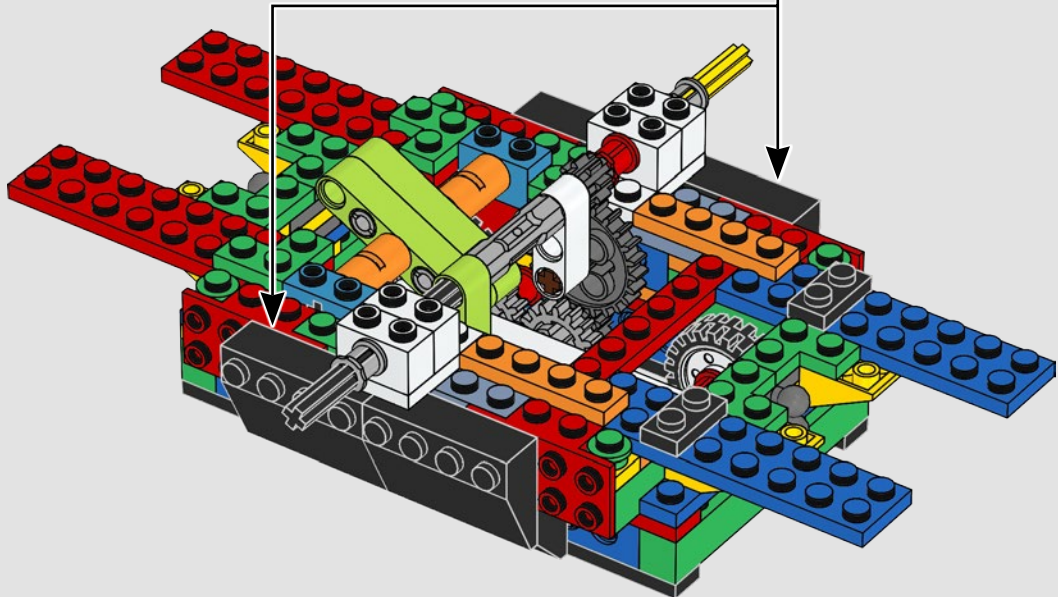
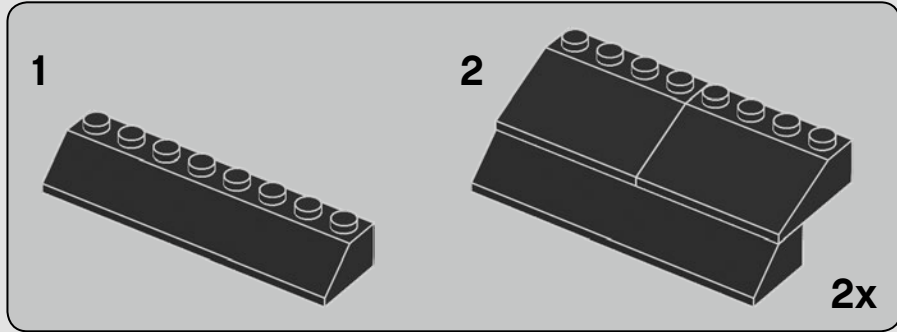

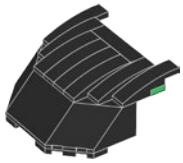

2x



1x



1x

43

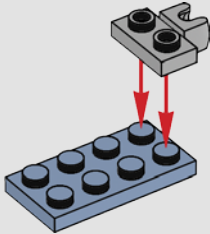

1x



1x

44

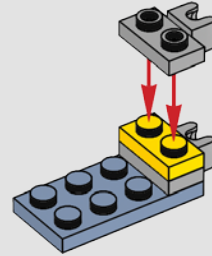

2x



1x

45

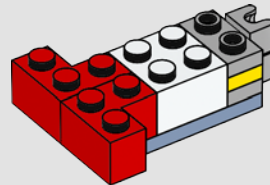

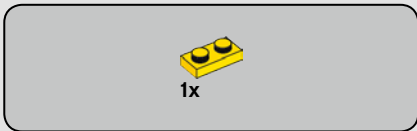

46

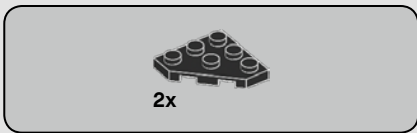
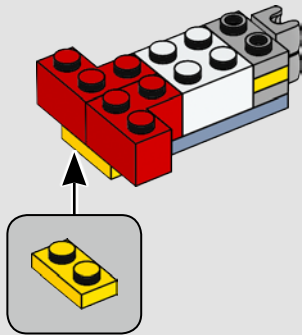

47

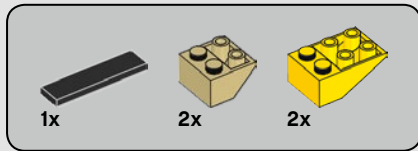
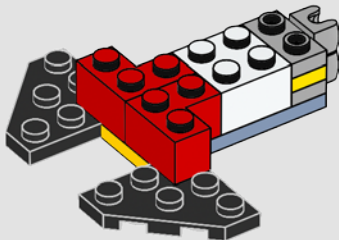

48

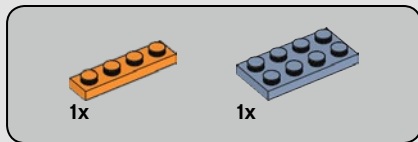
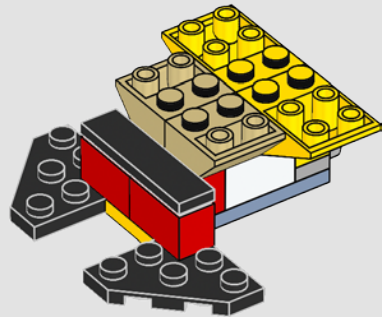

49

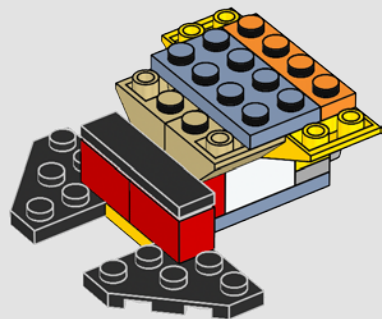

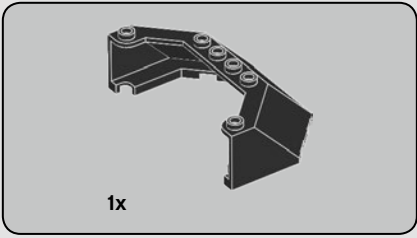

50

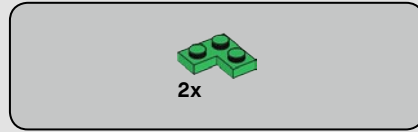
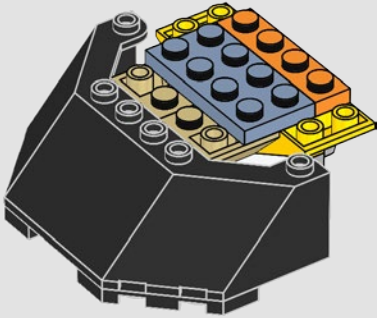

51

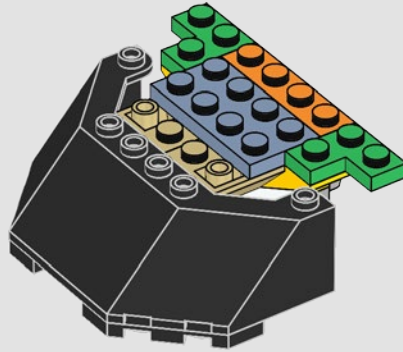

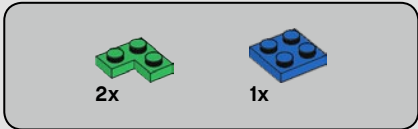

52

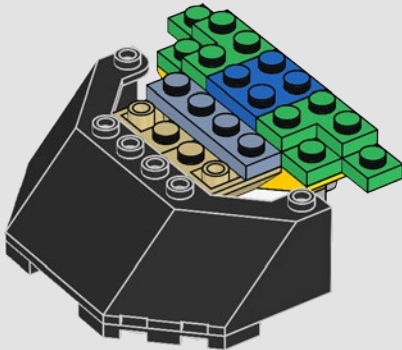

53

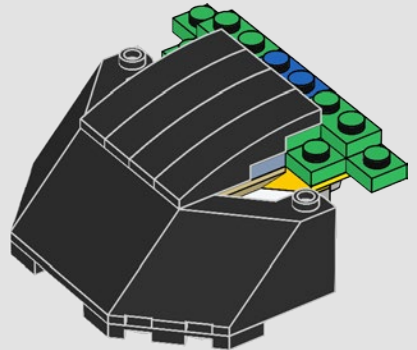



54

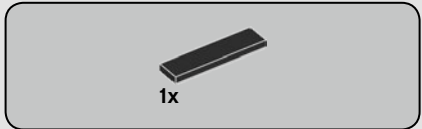
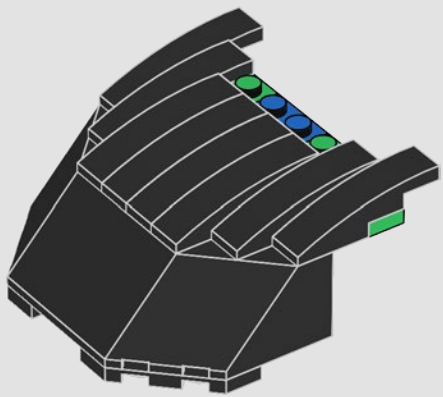

55

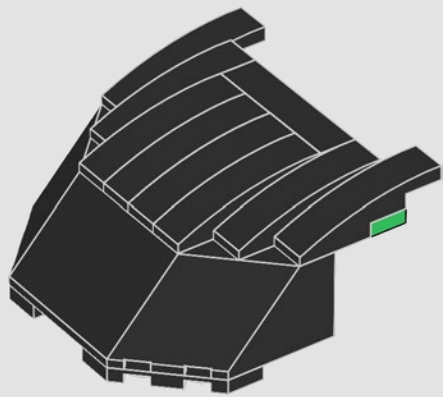

2x

56

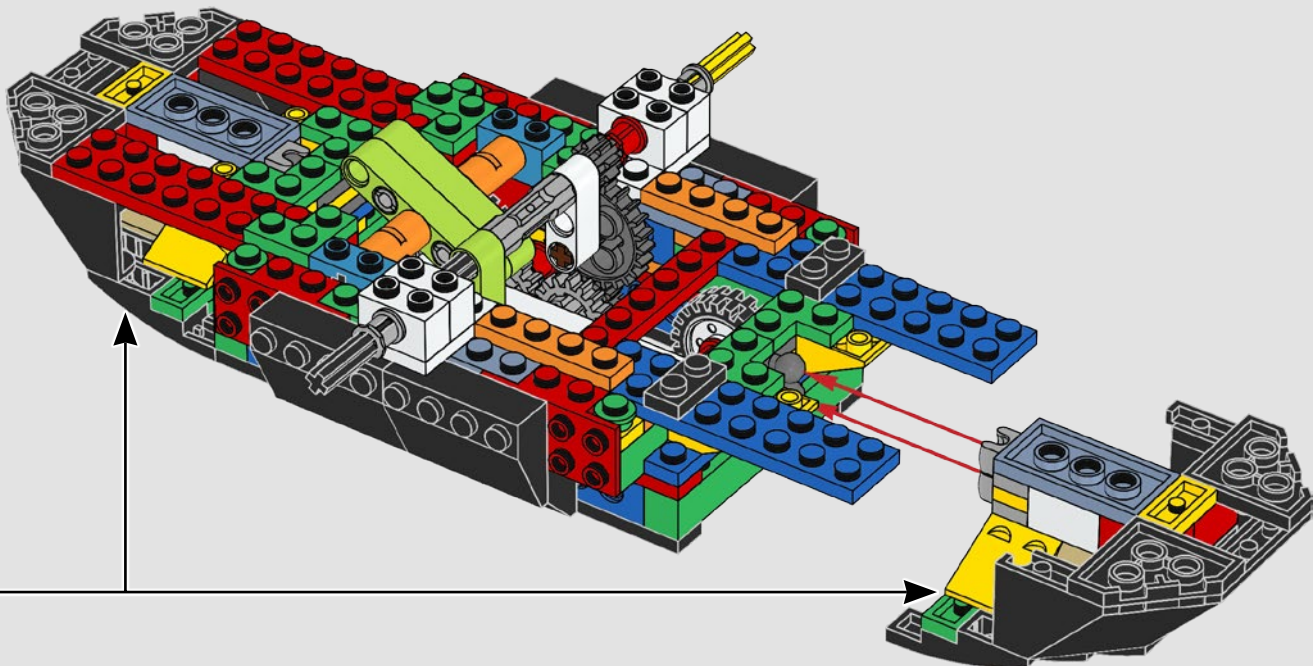

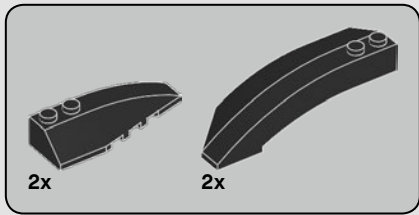

57

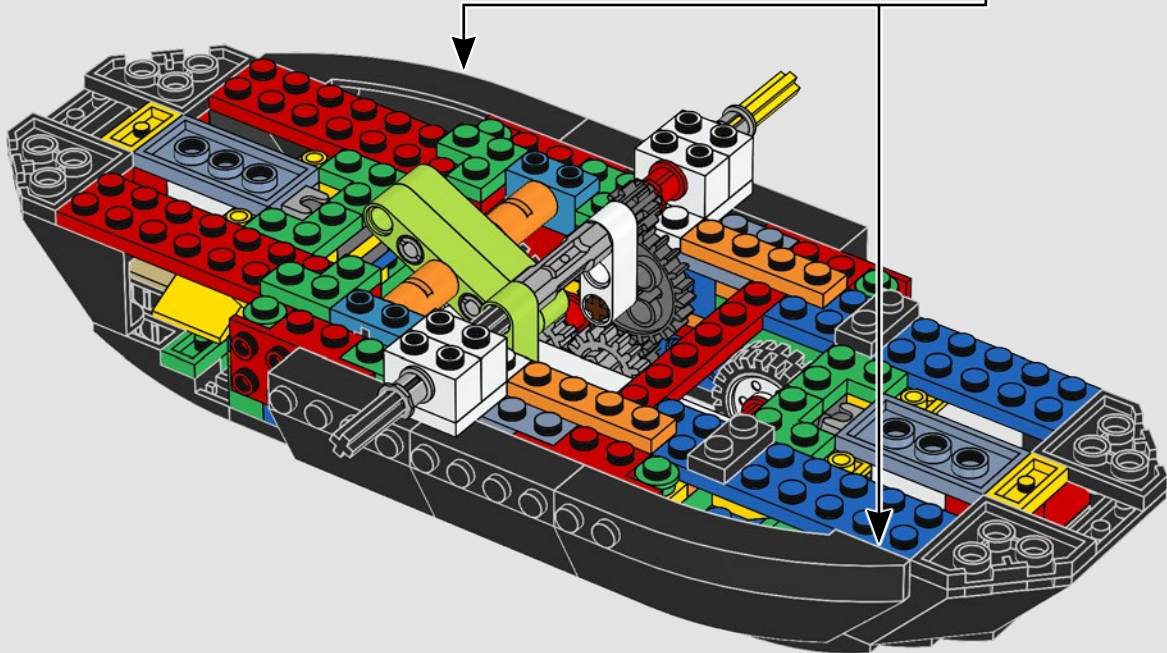
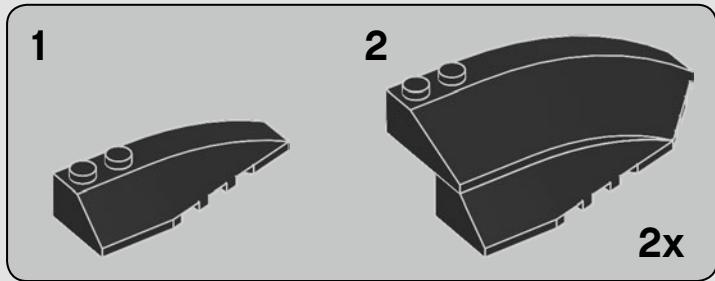

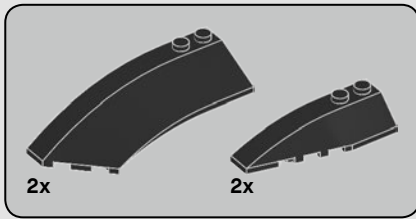

58

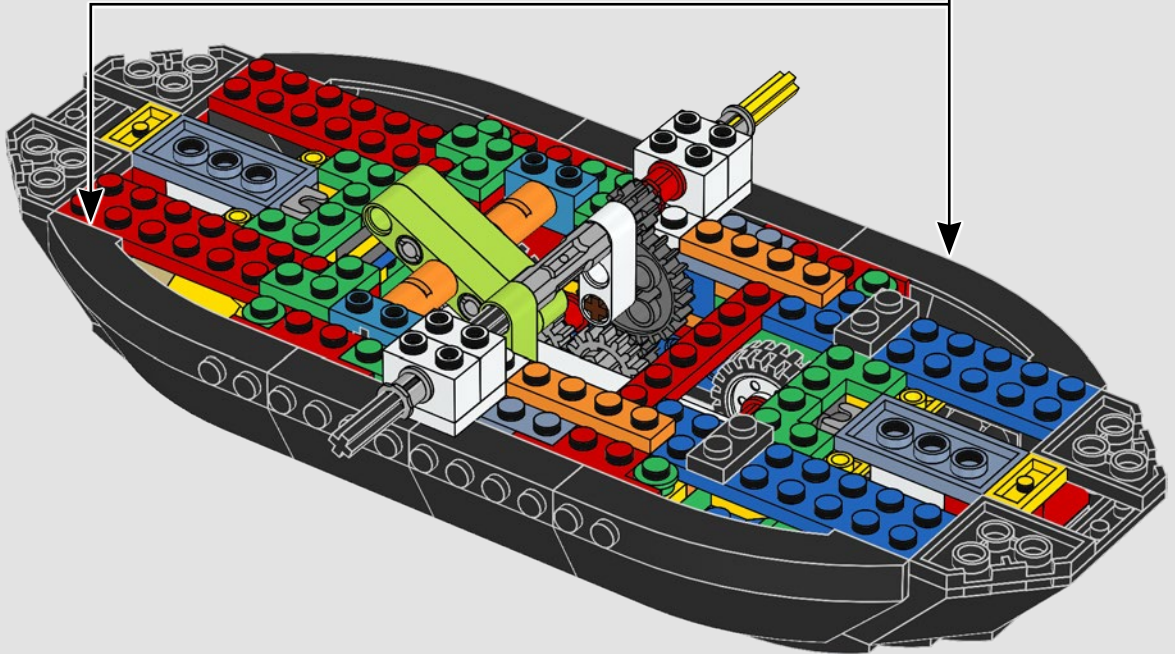
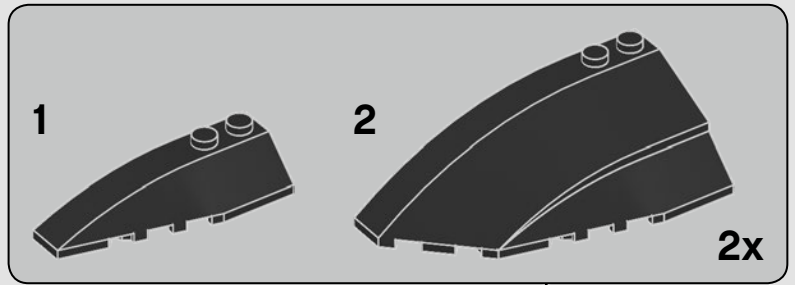

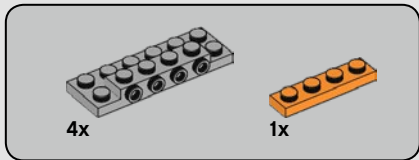

59

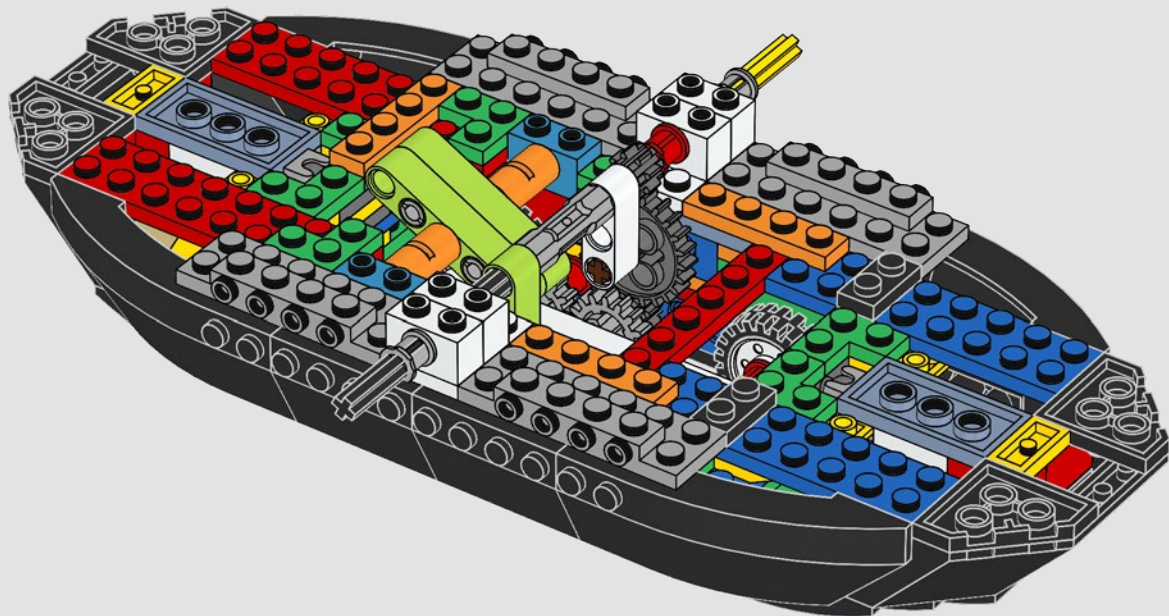



60

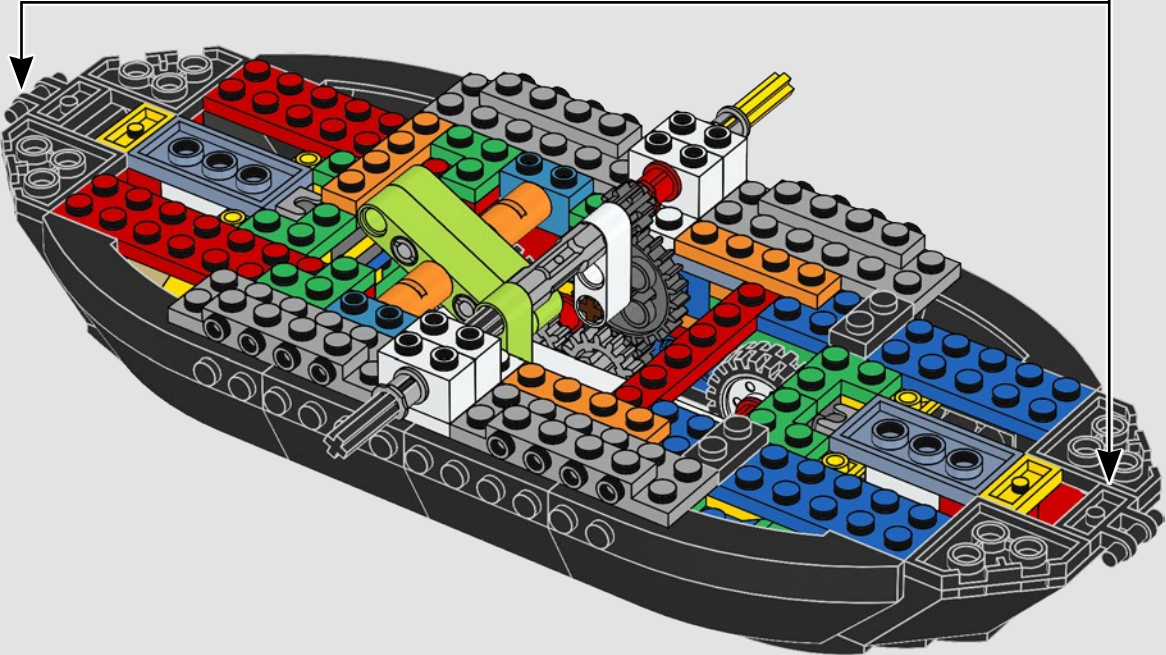

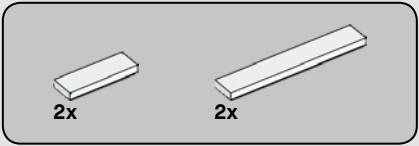

61

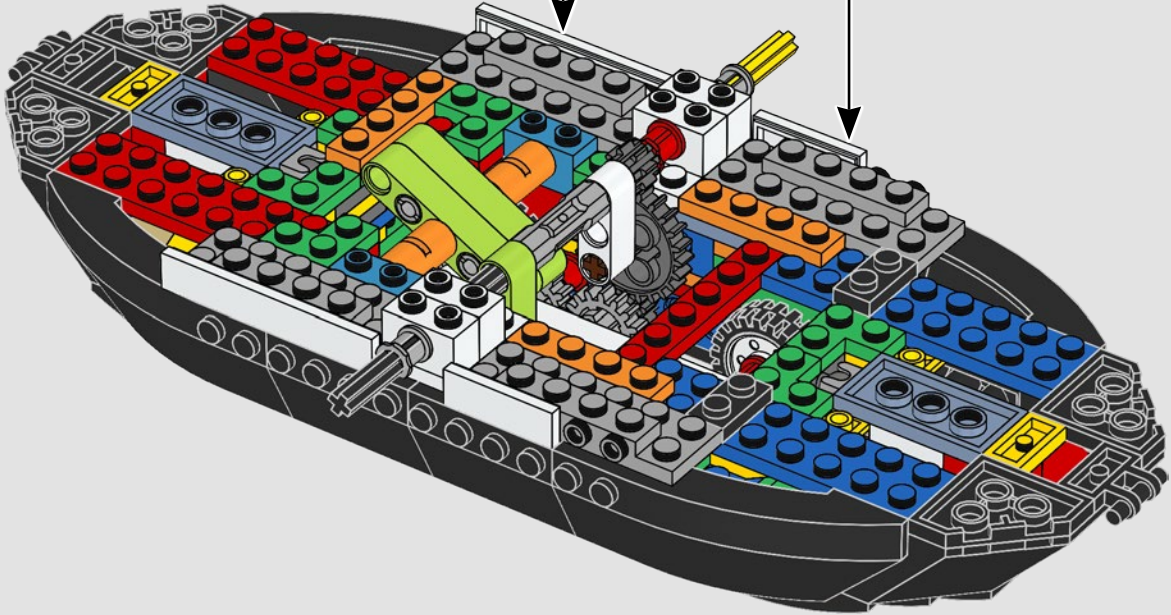
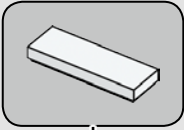
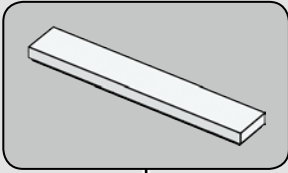

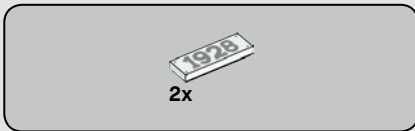

62

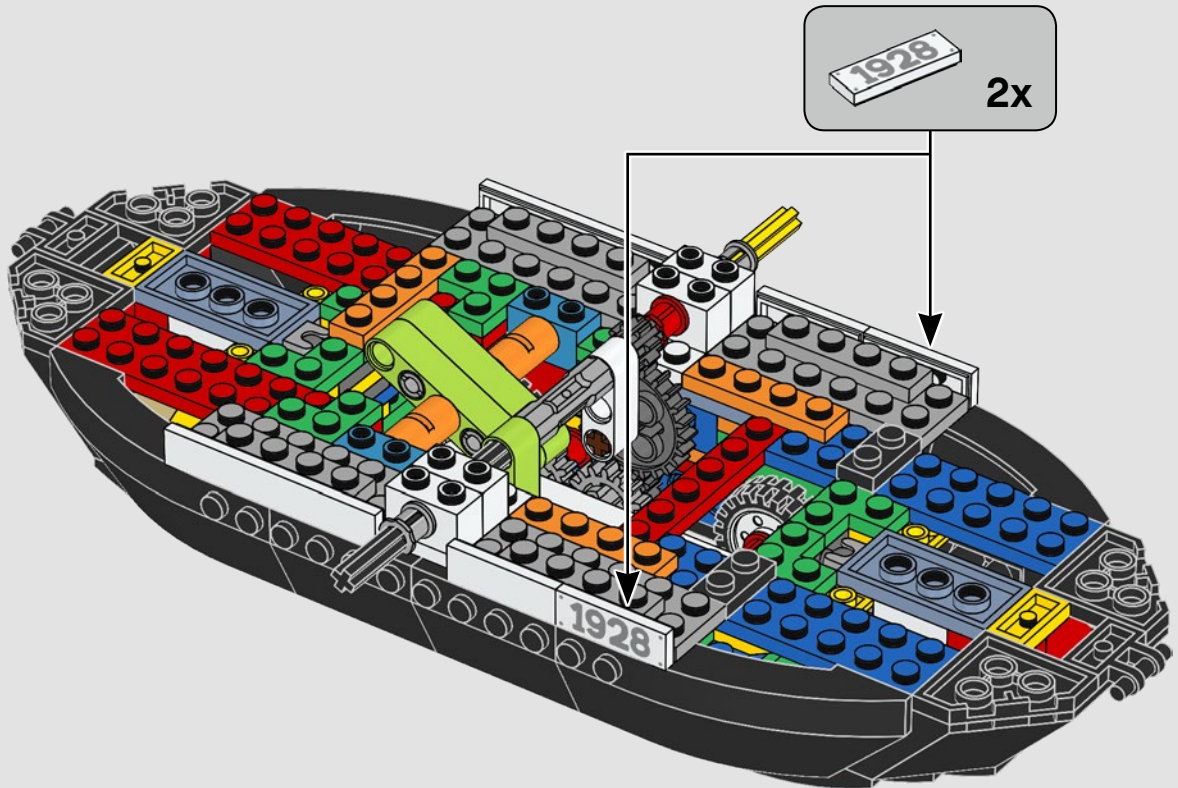

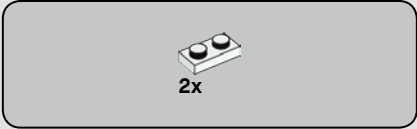
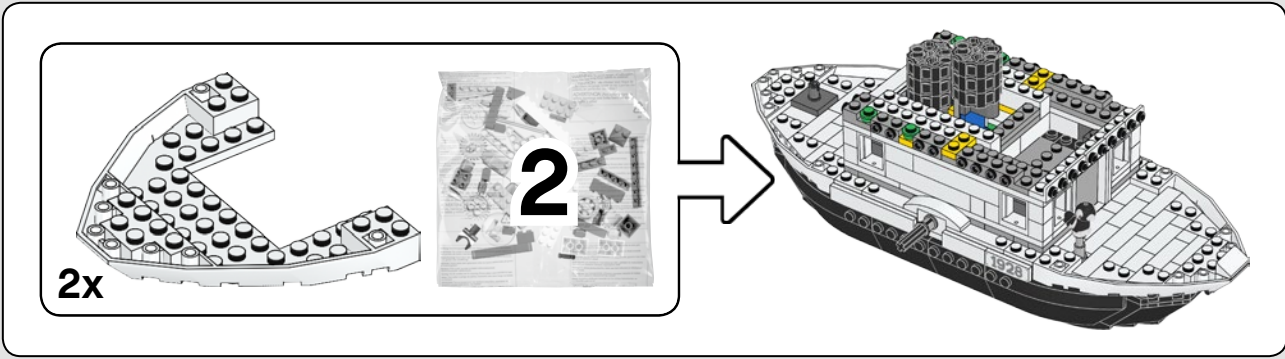

63

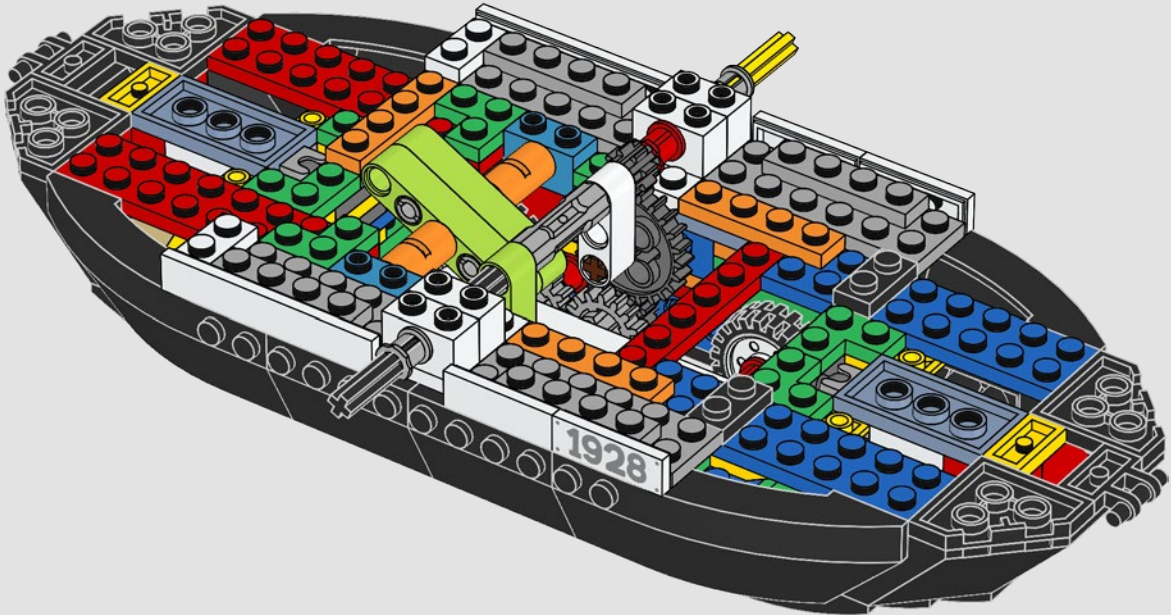

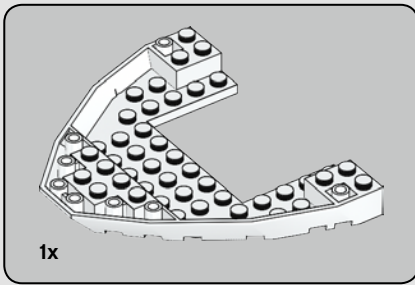

64

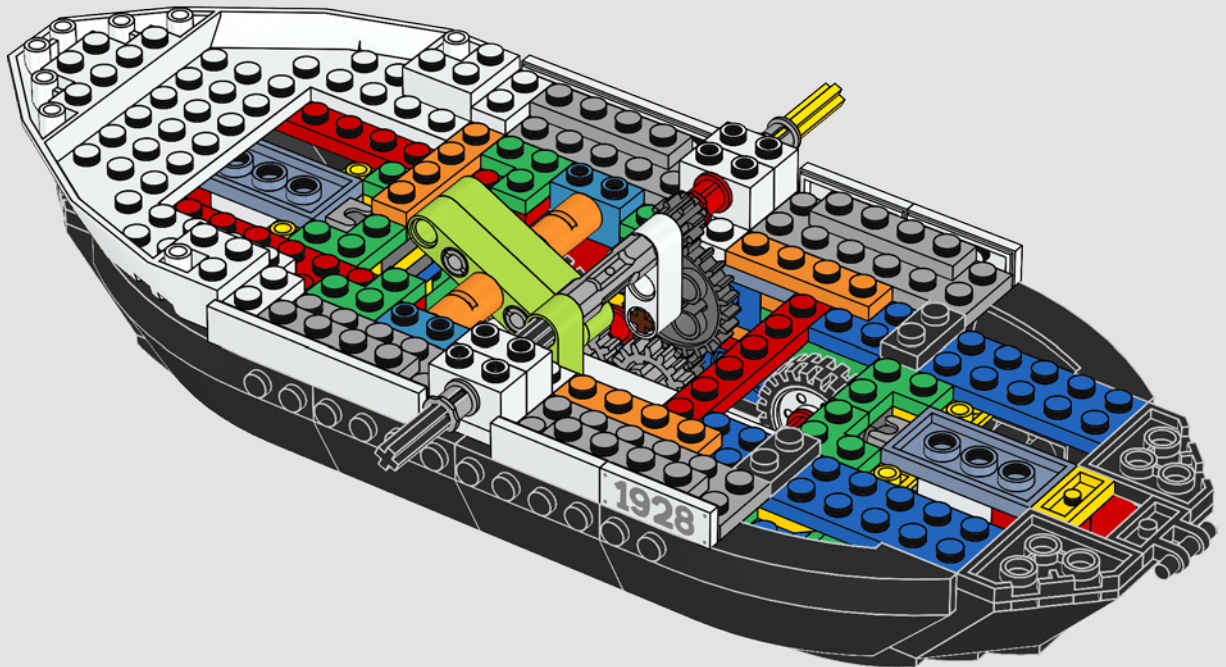

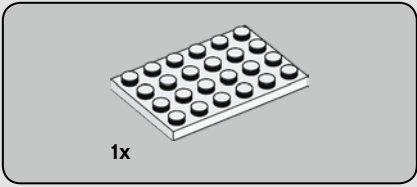

65

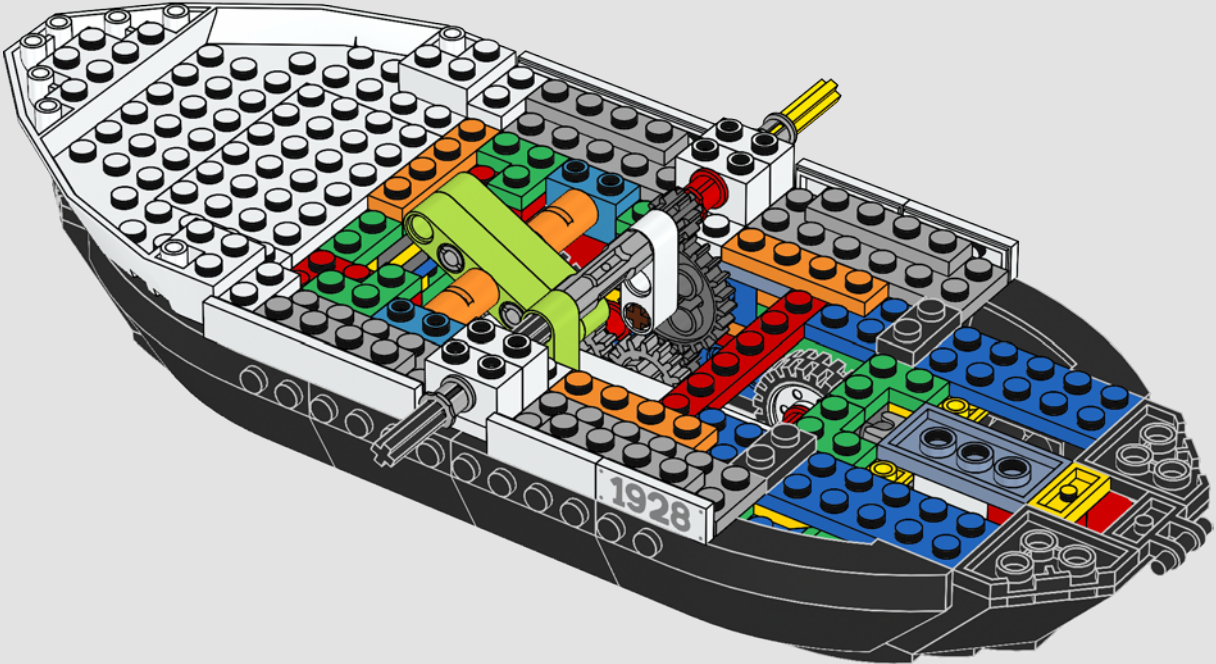

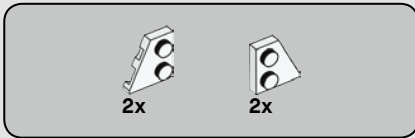

66

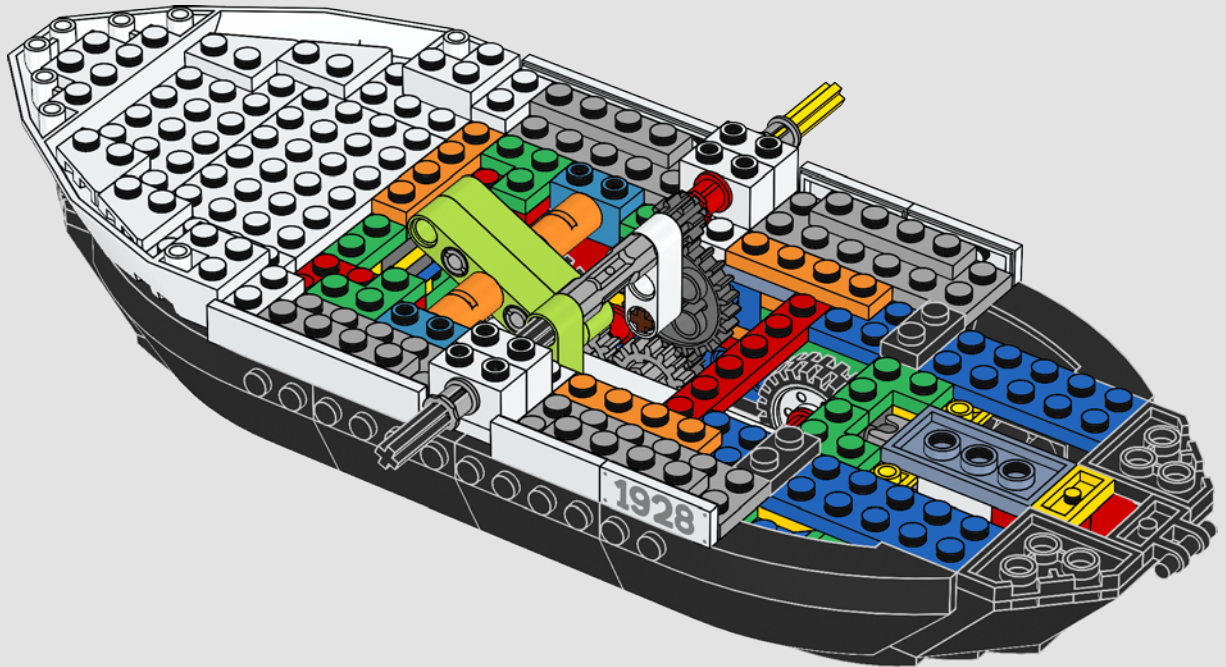



2x

67

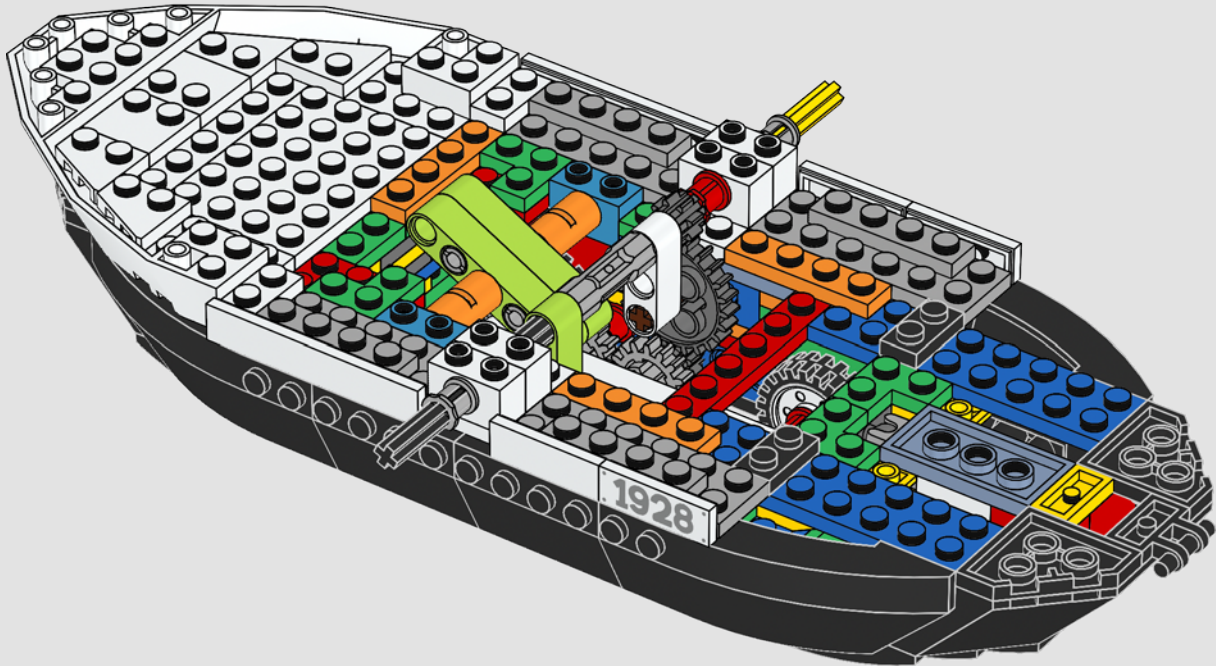

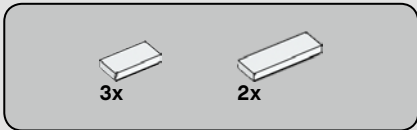

68

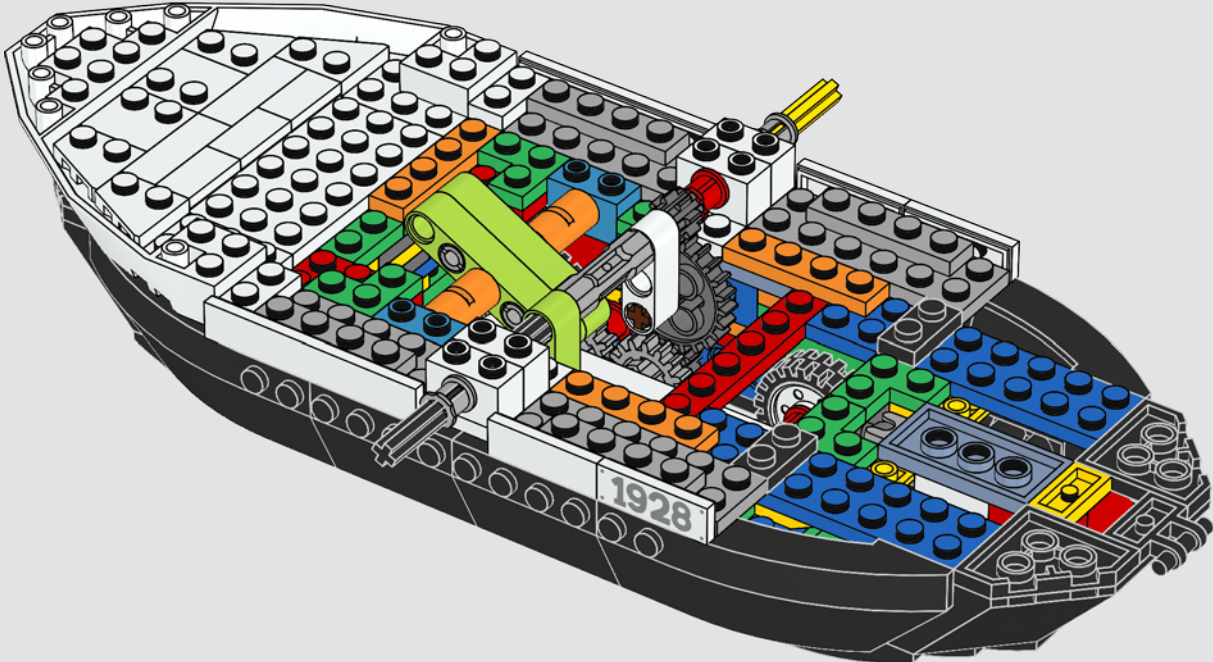

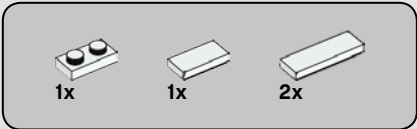

69

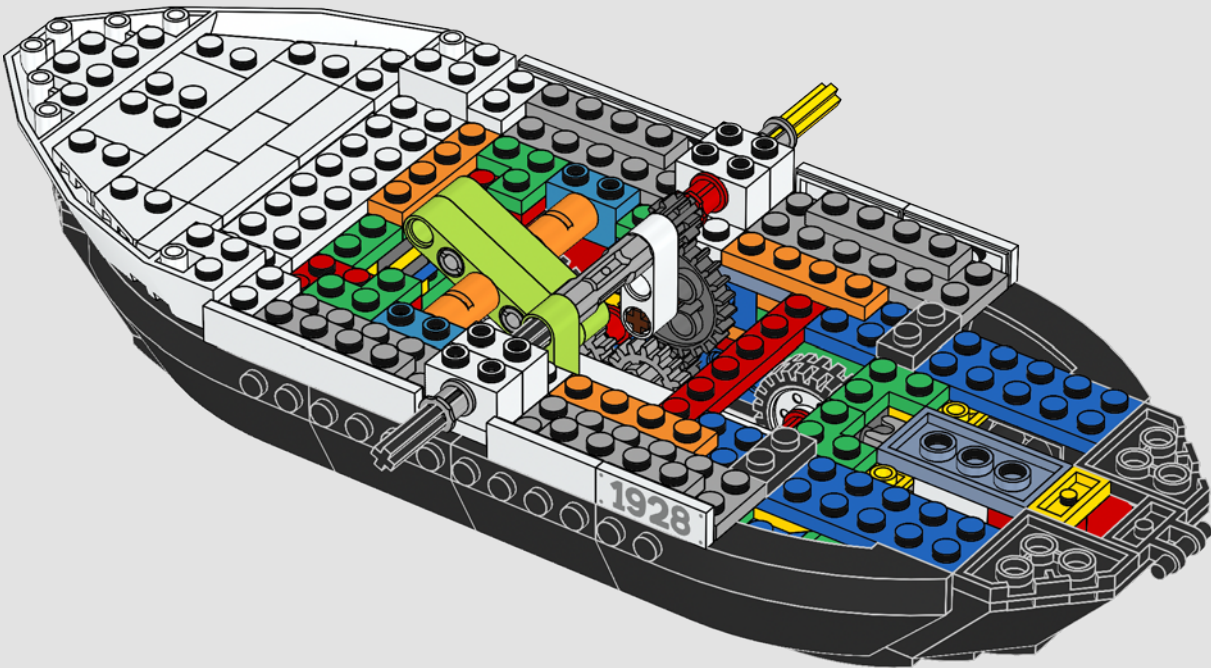

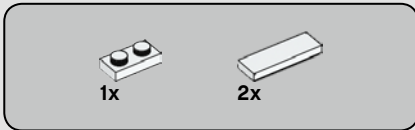

70

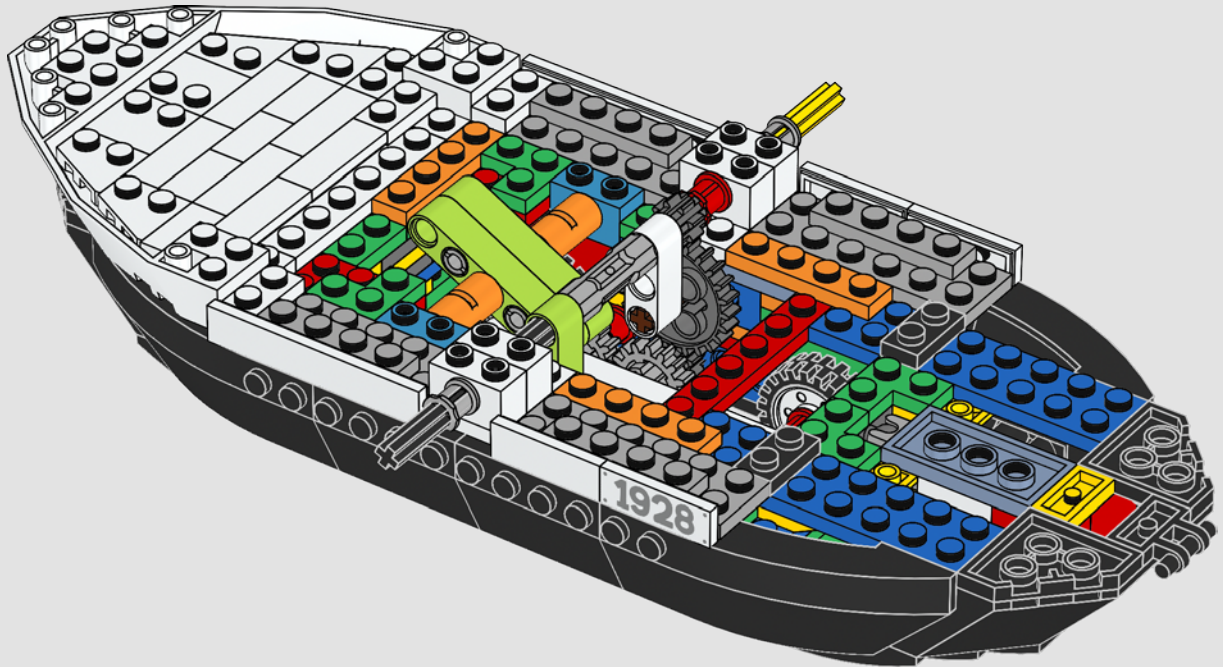

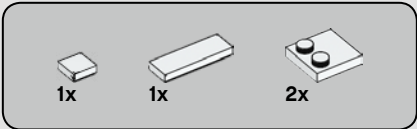

71

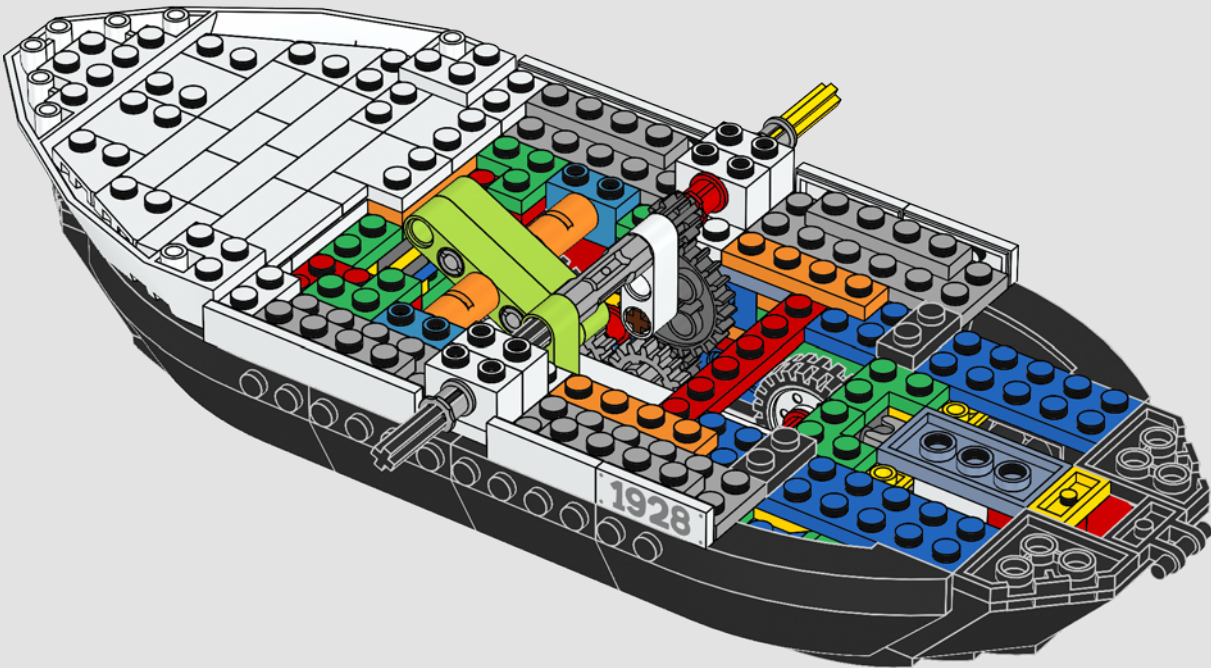

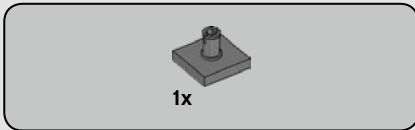

72

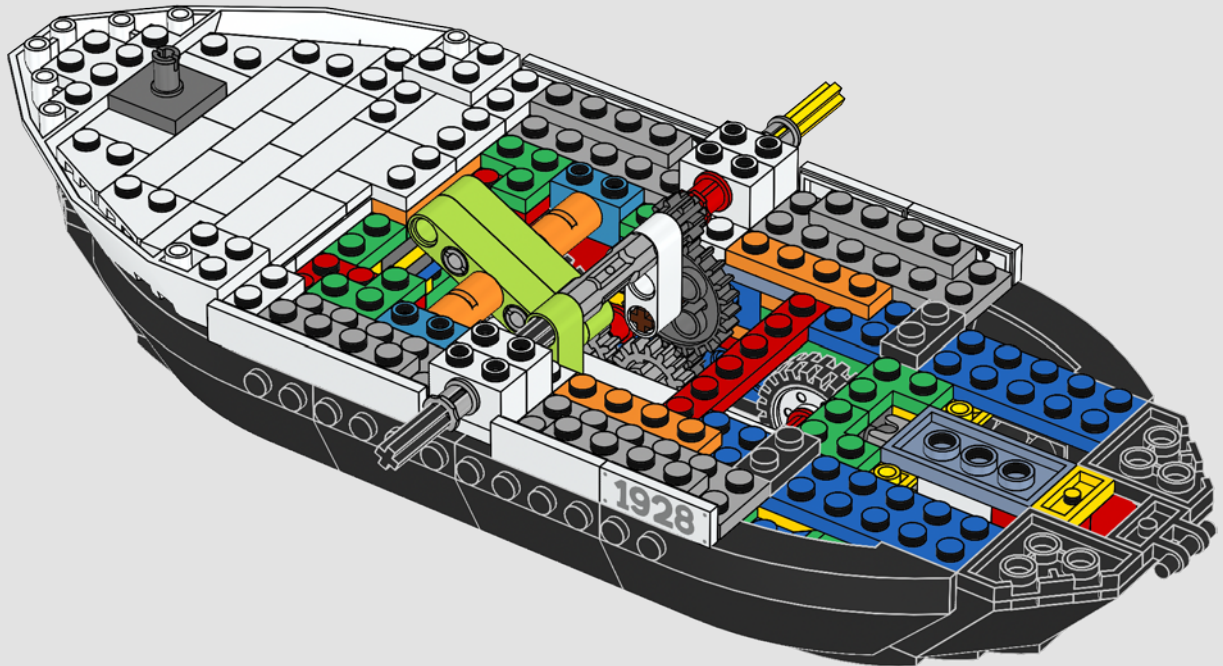

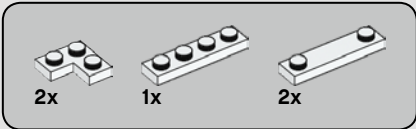

73

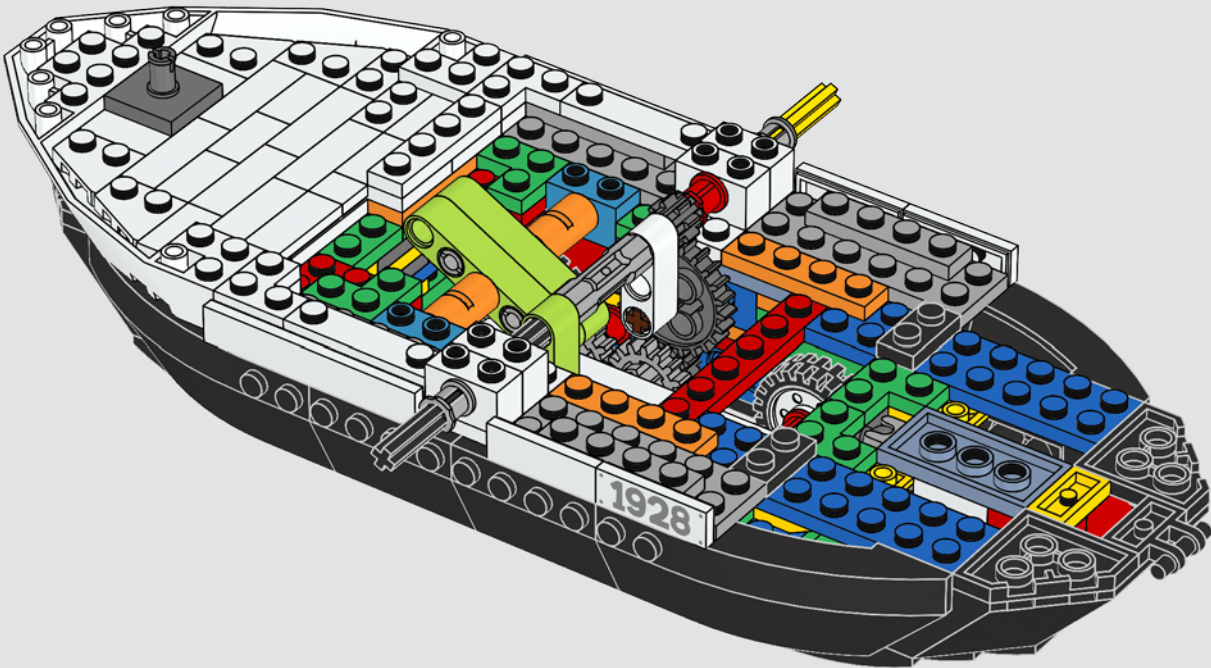

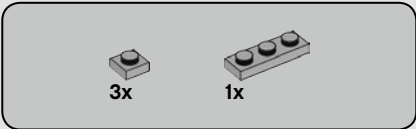

74

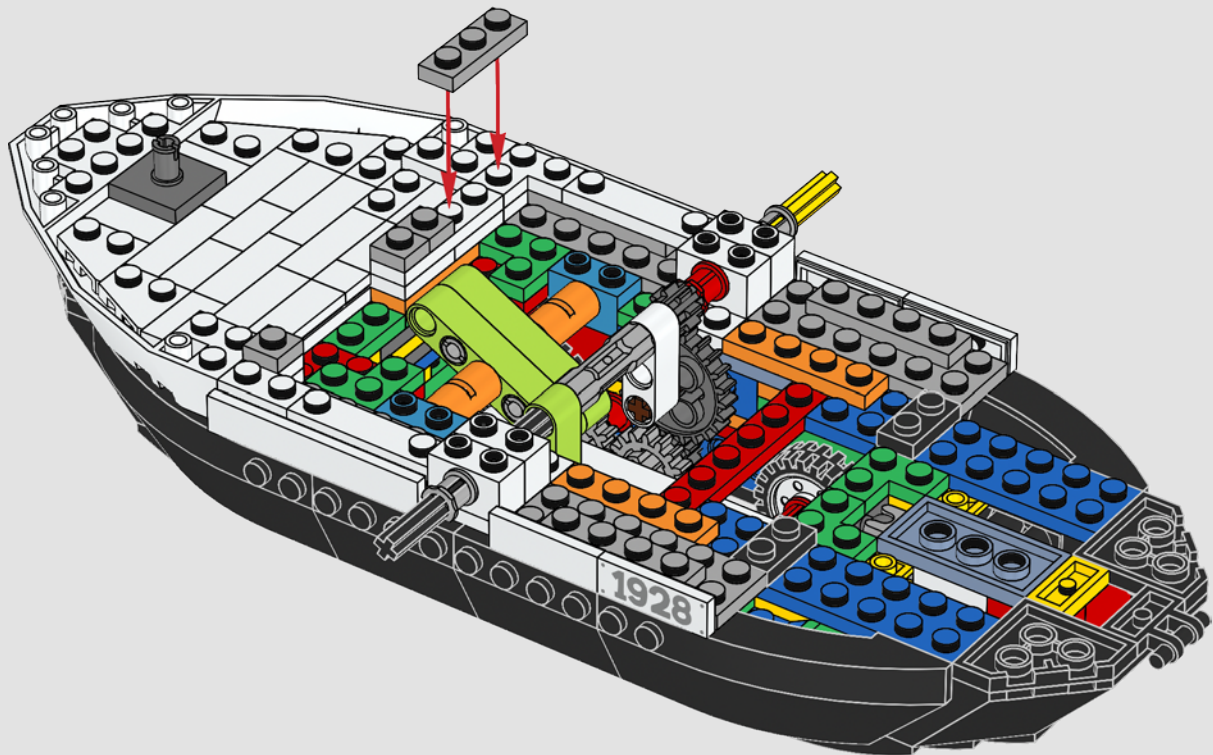

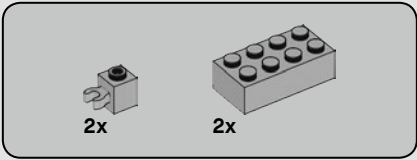

75

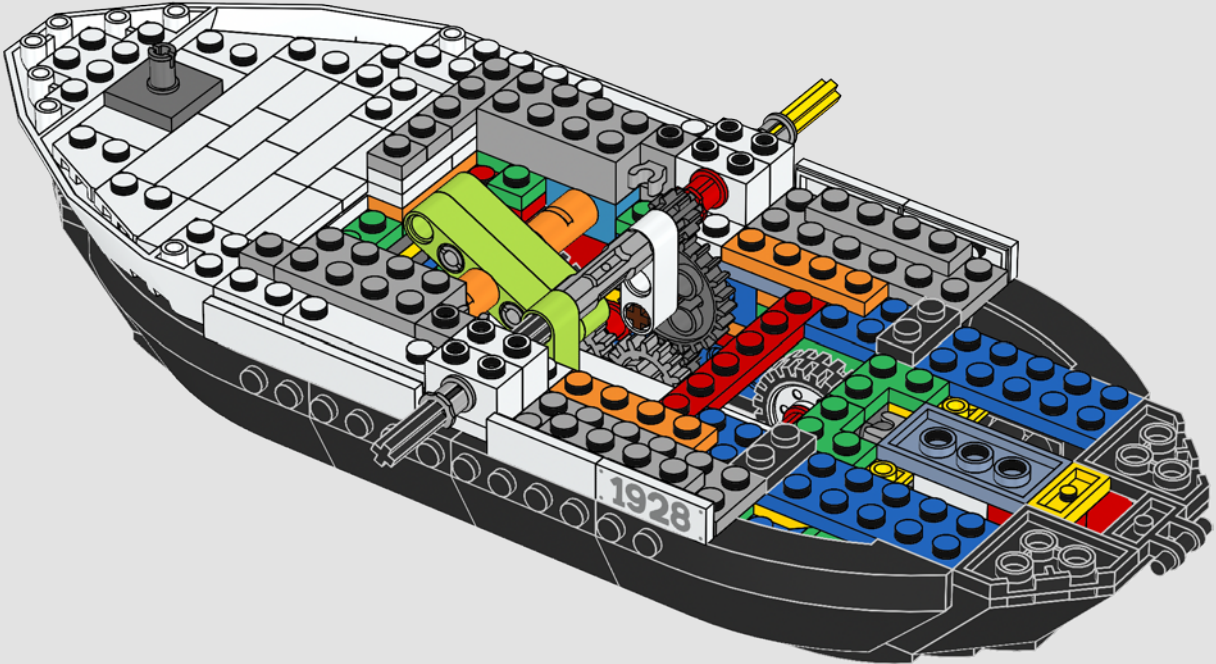

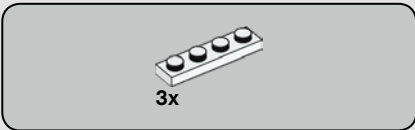

76

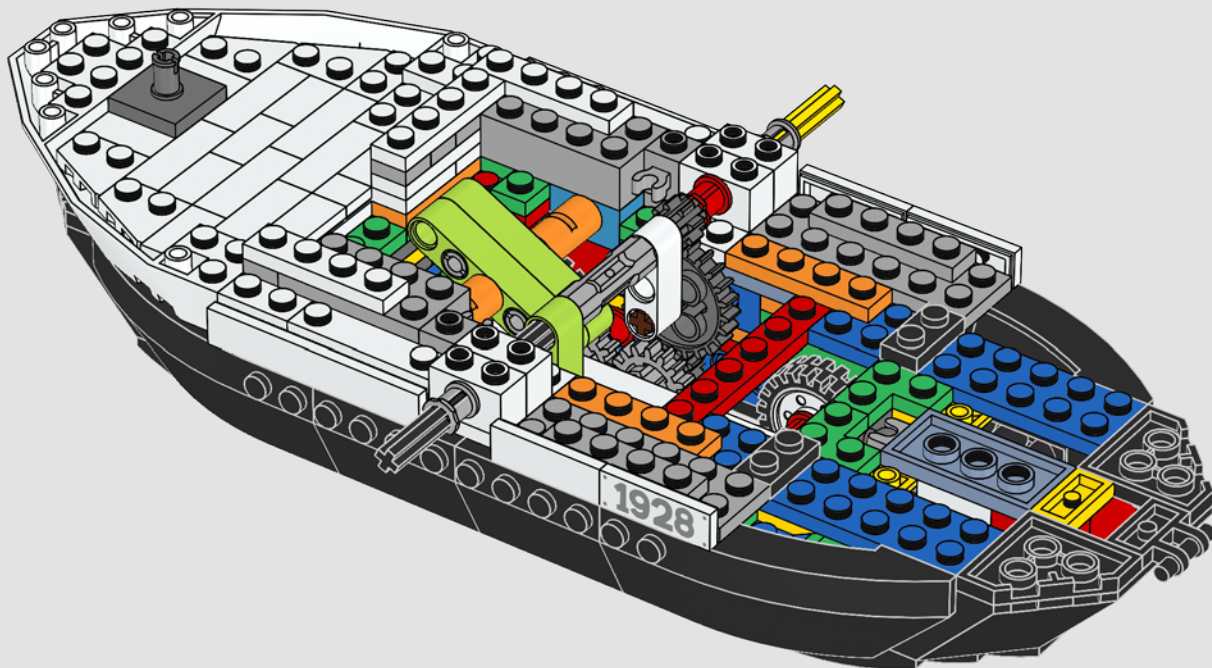

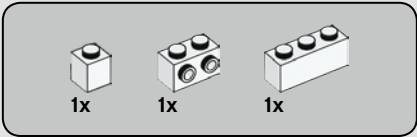

77

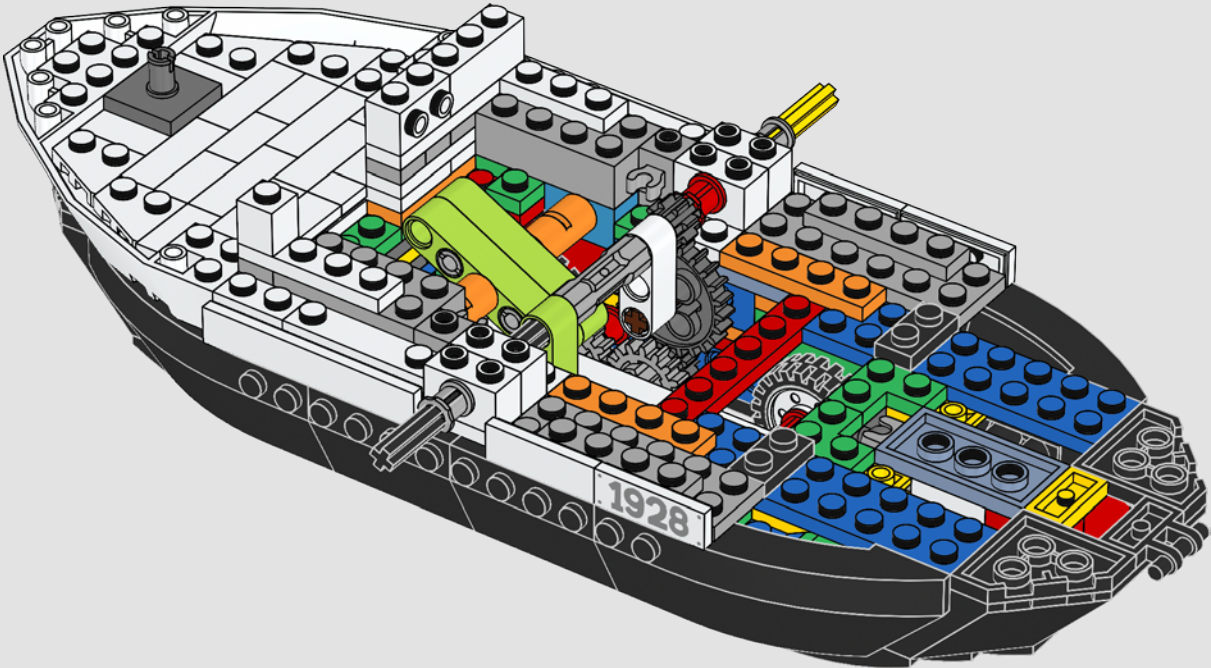

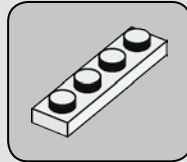
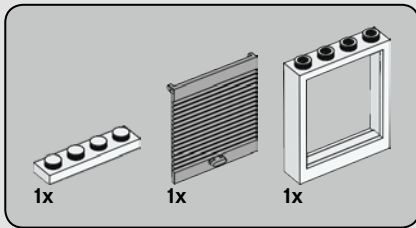

78

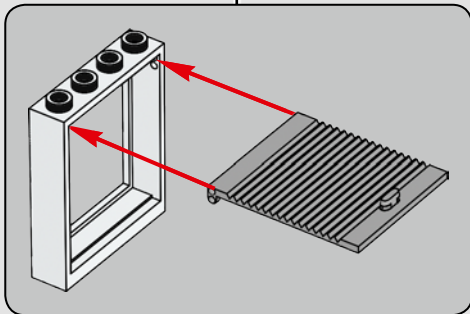
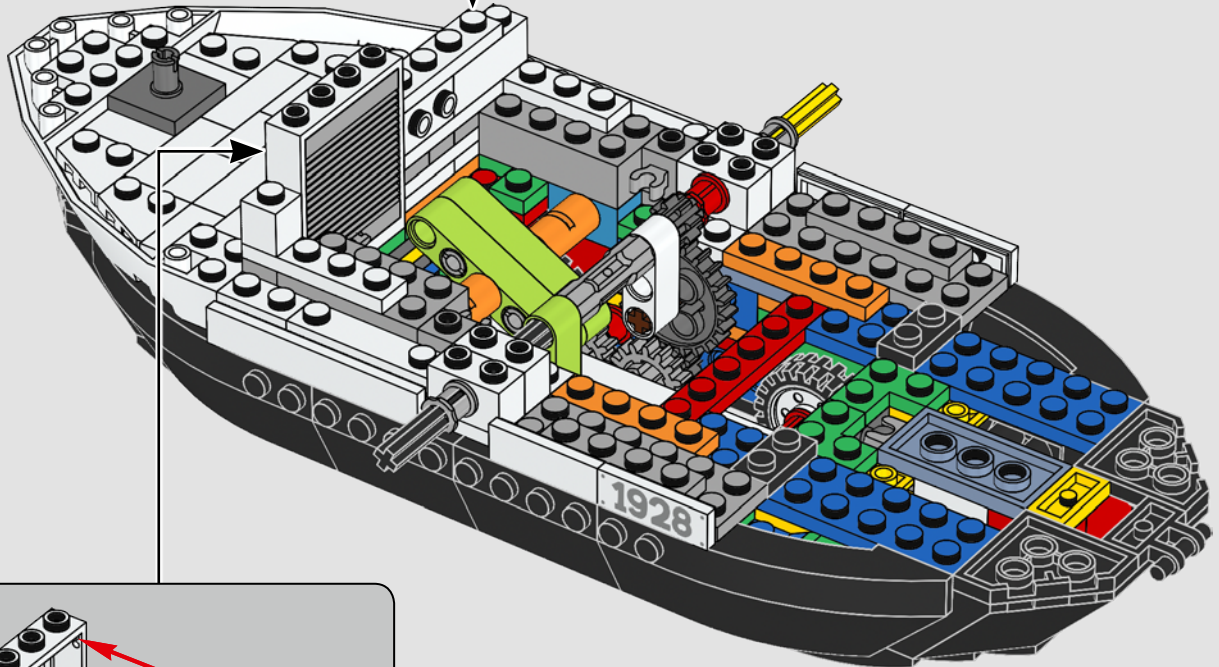



4x



2x

79

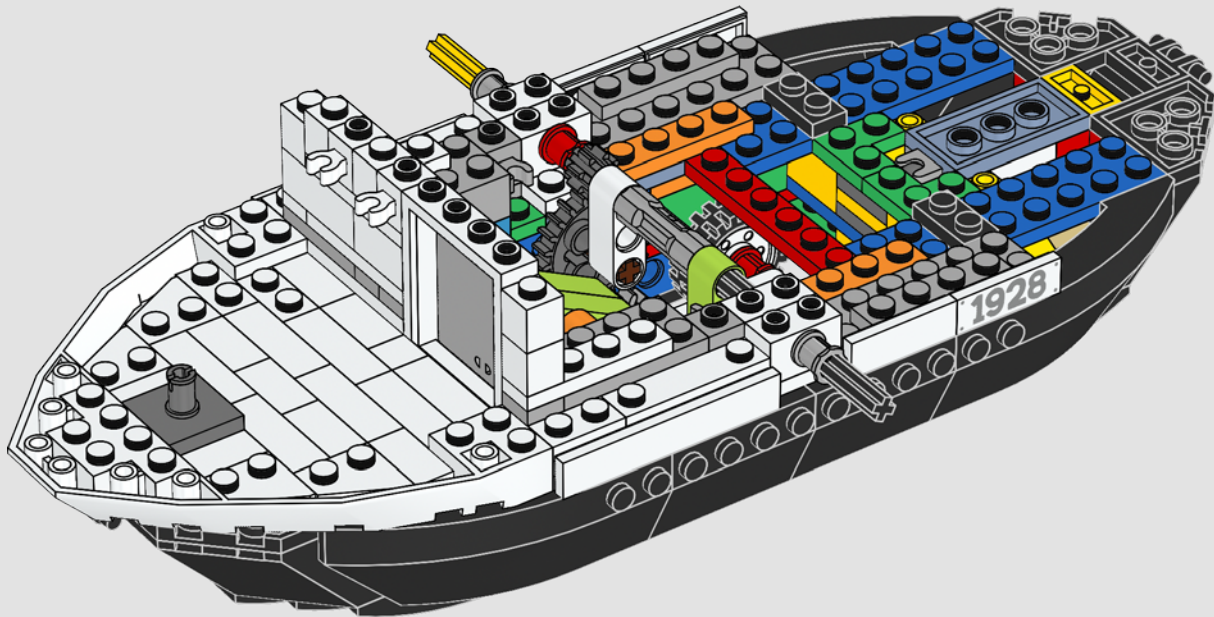

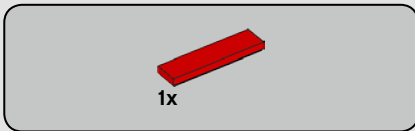

80

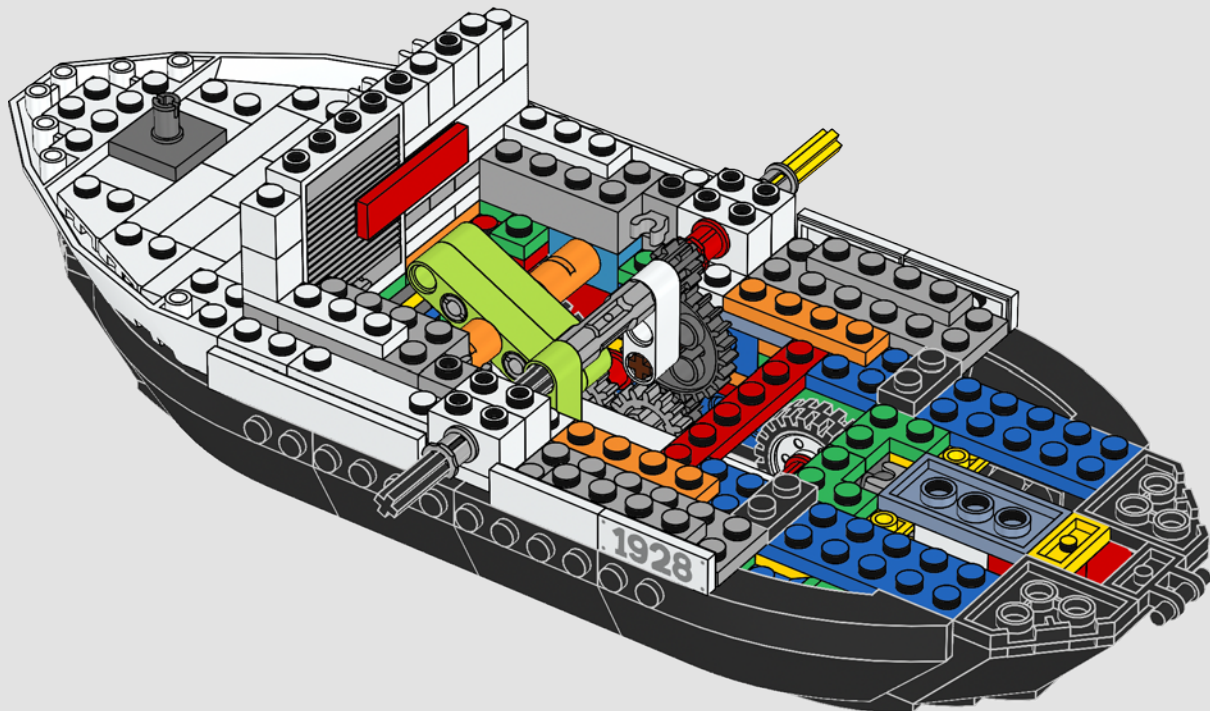



2x

81

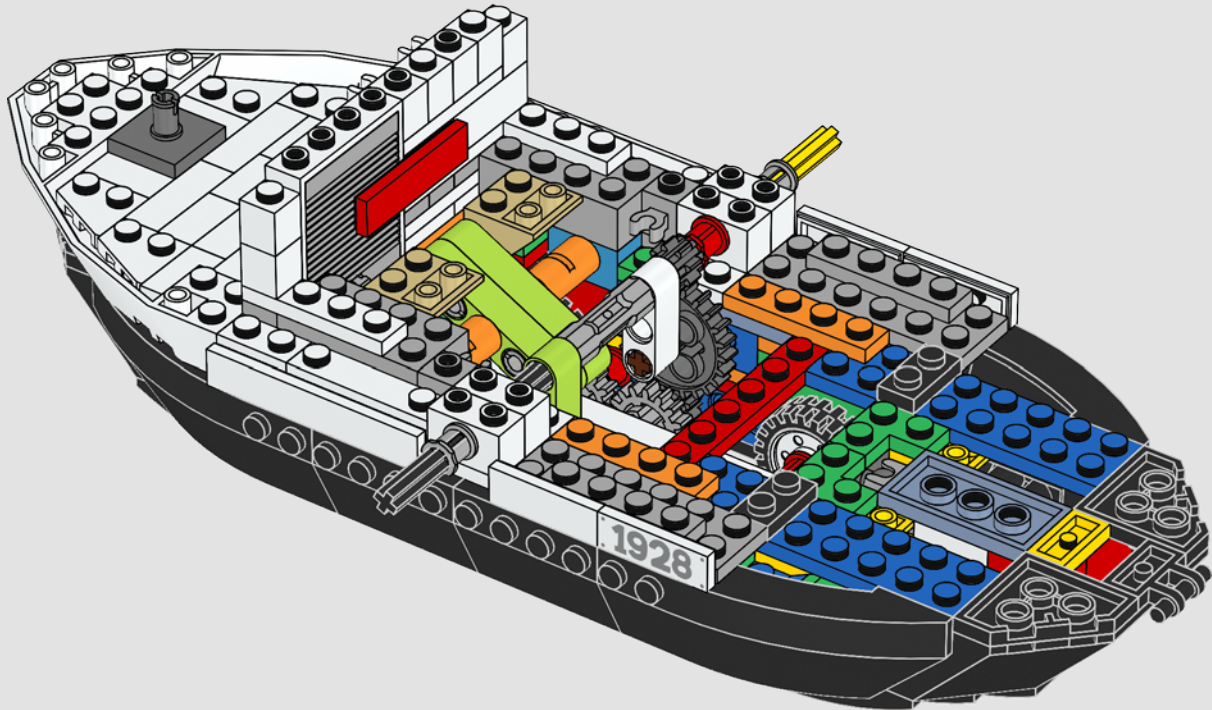

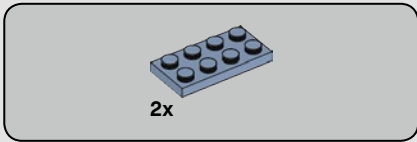

82

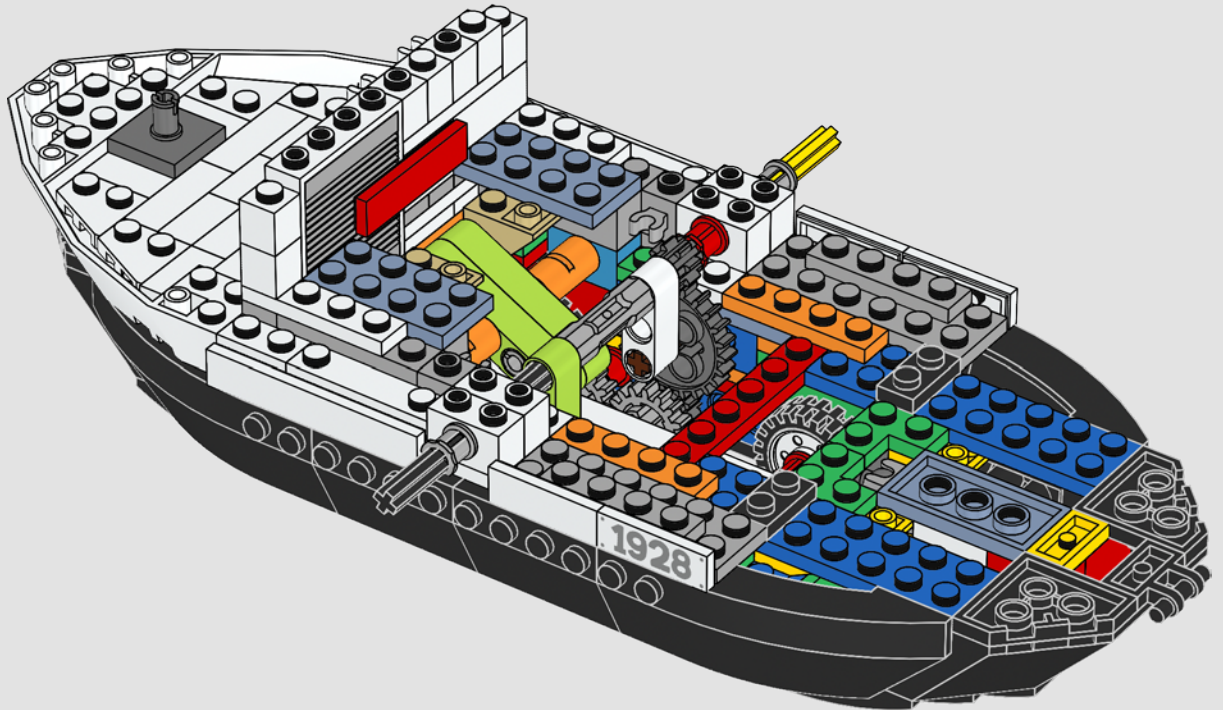

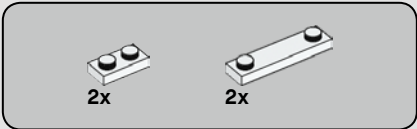

83

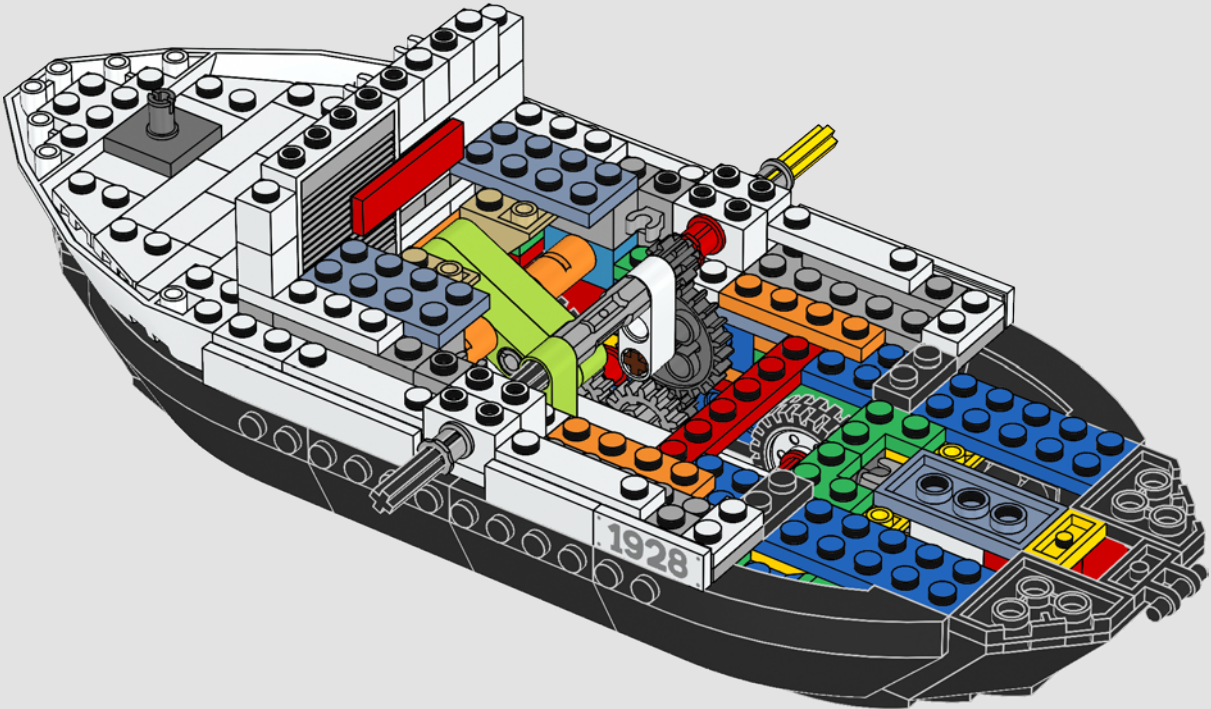

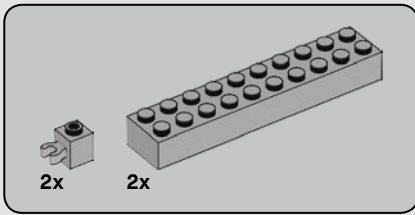

84

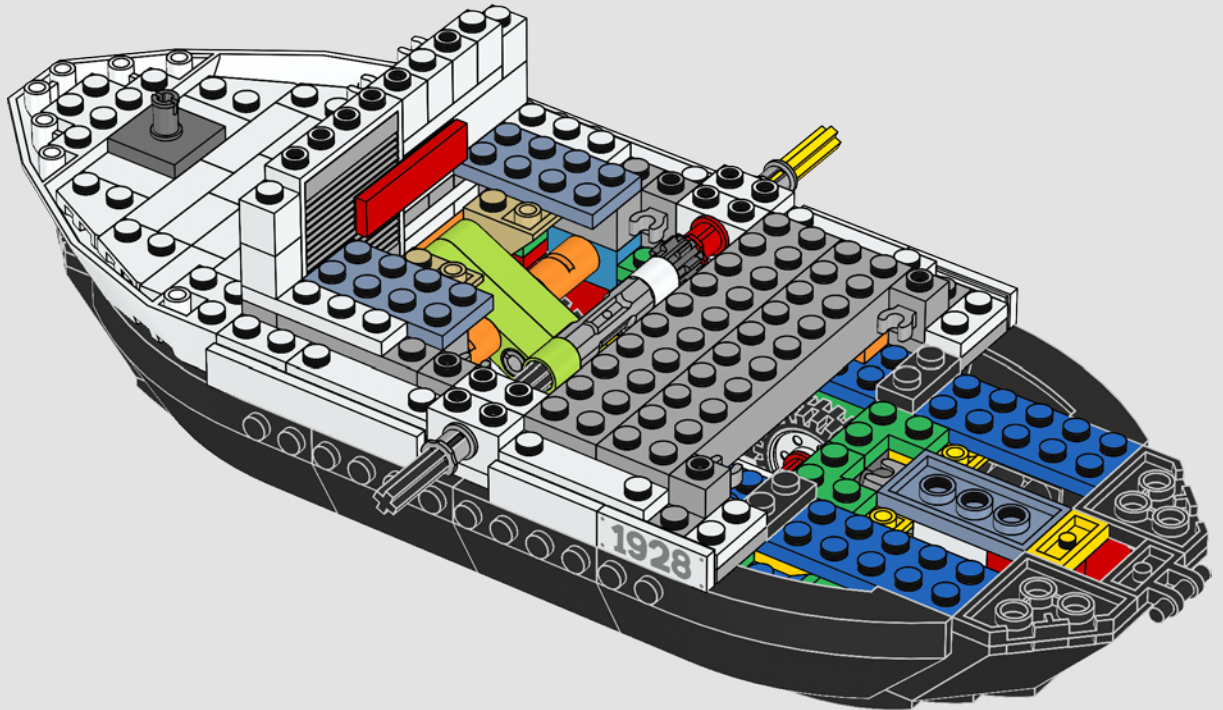

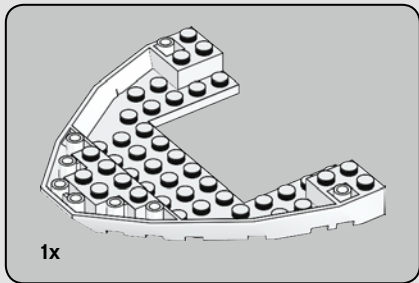

85

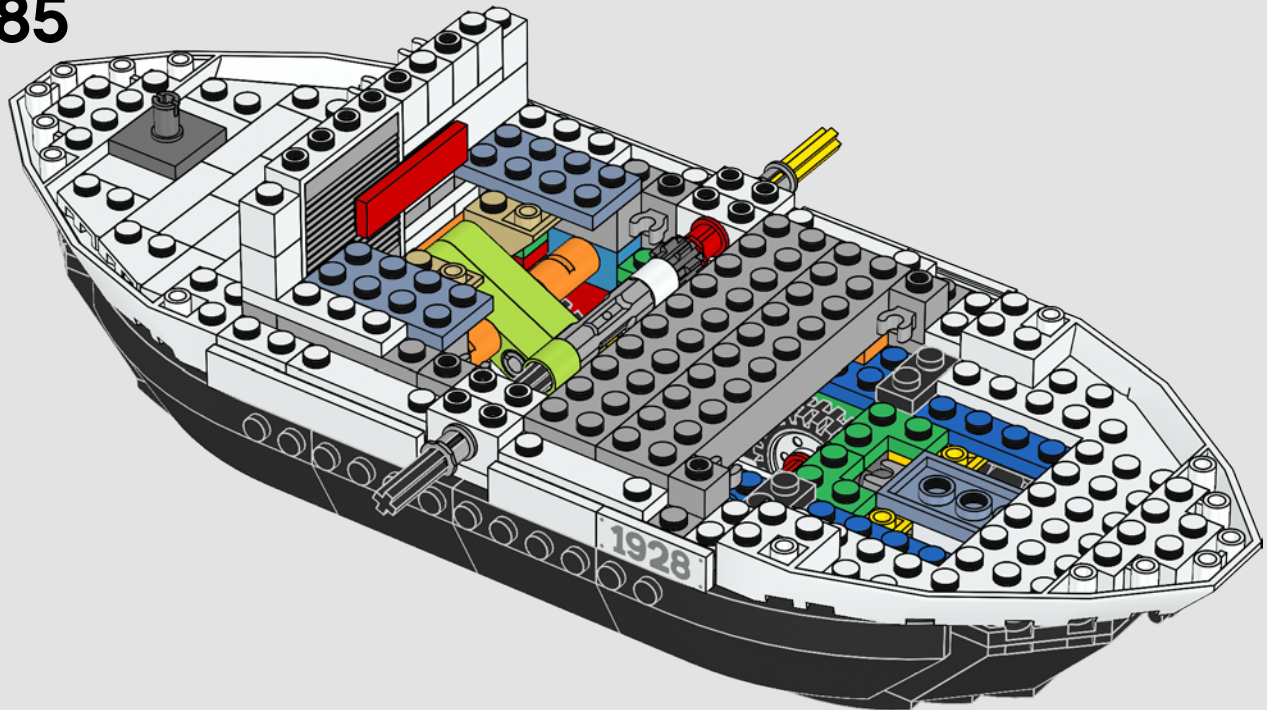

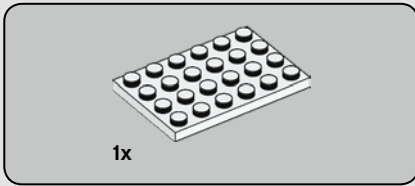

86

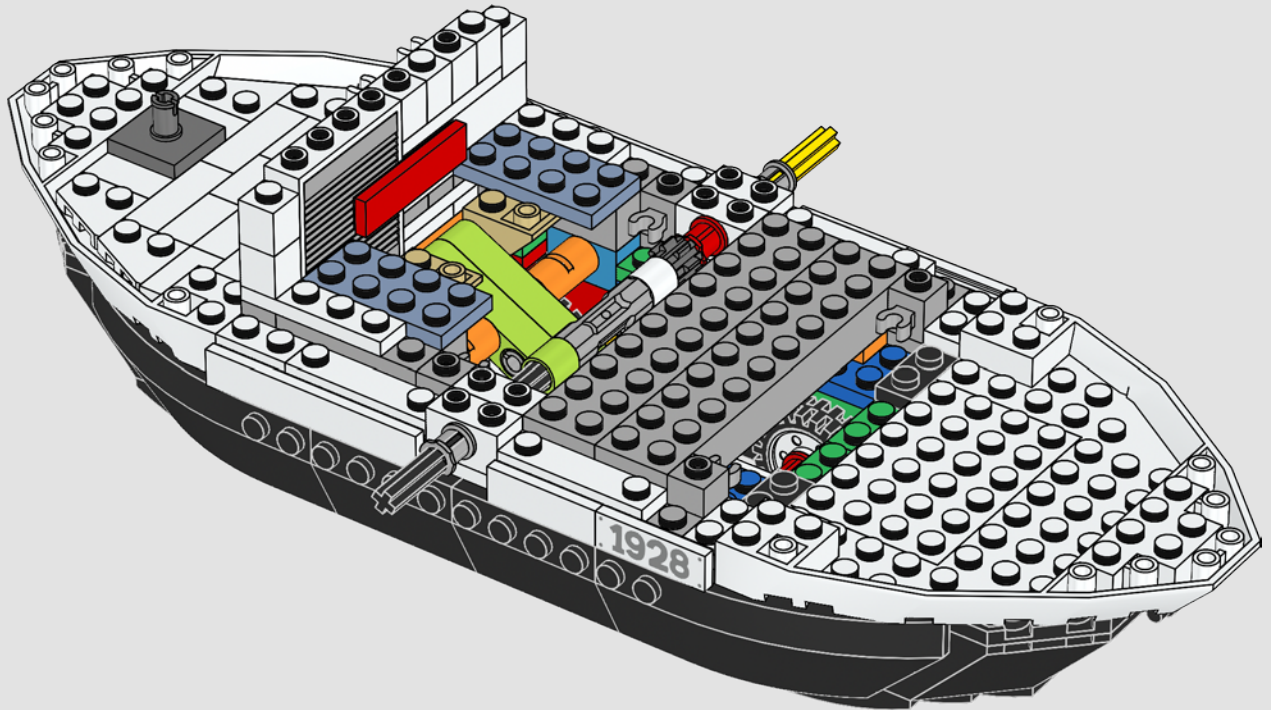

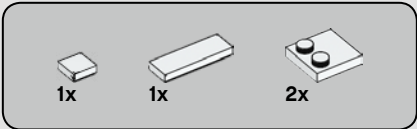

87

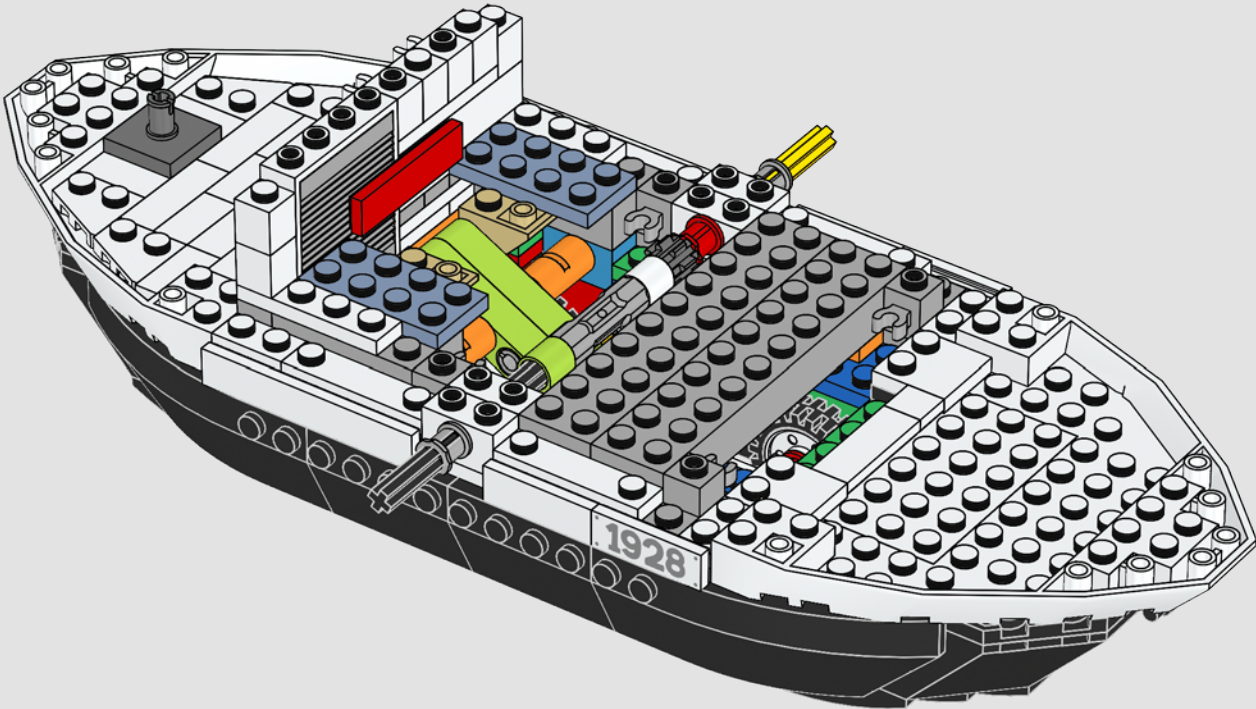

2x 2x

88

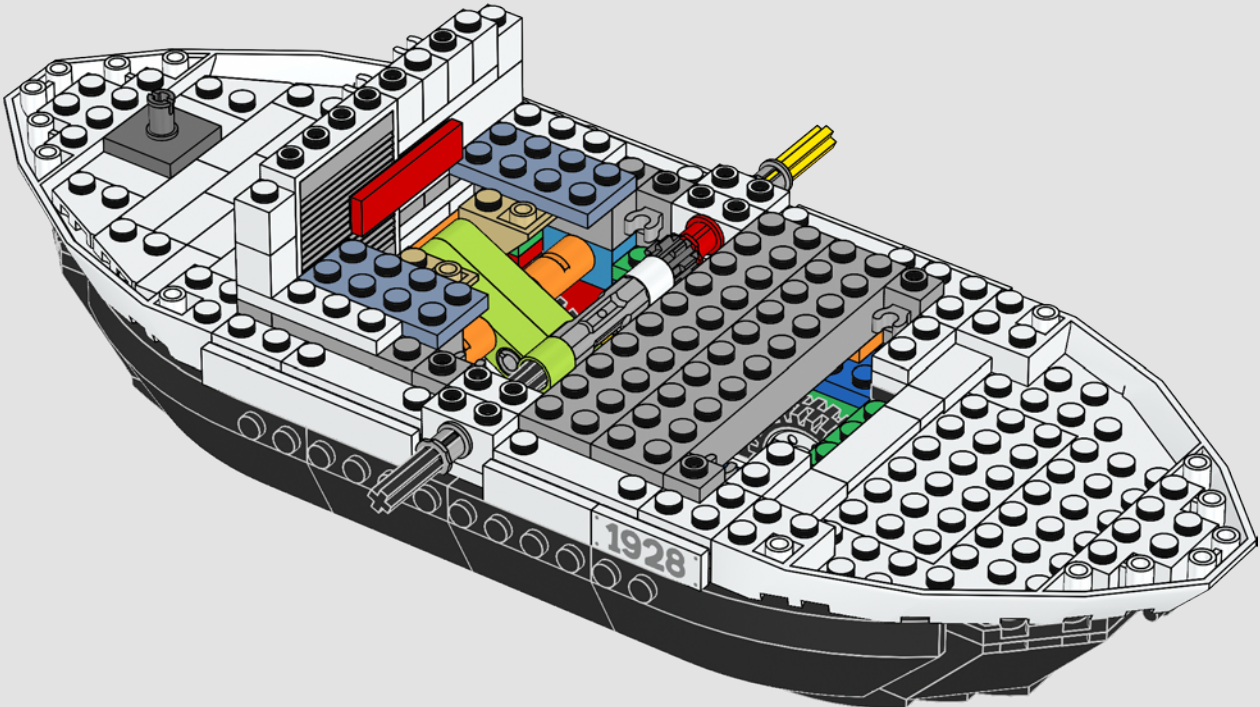



2x

89

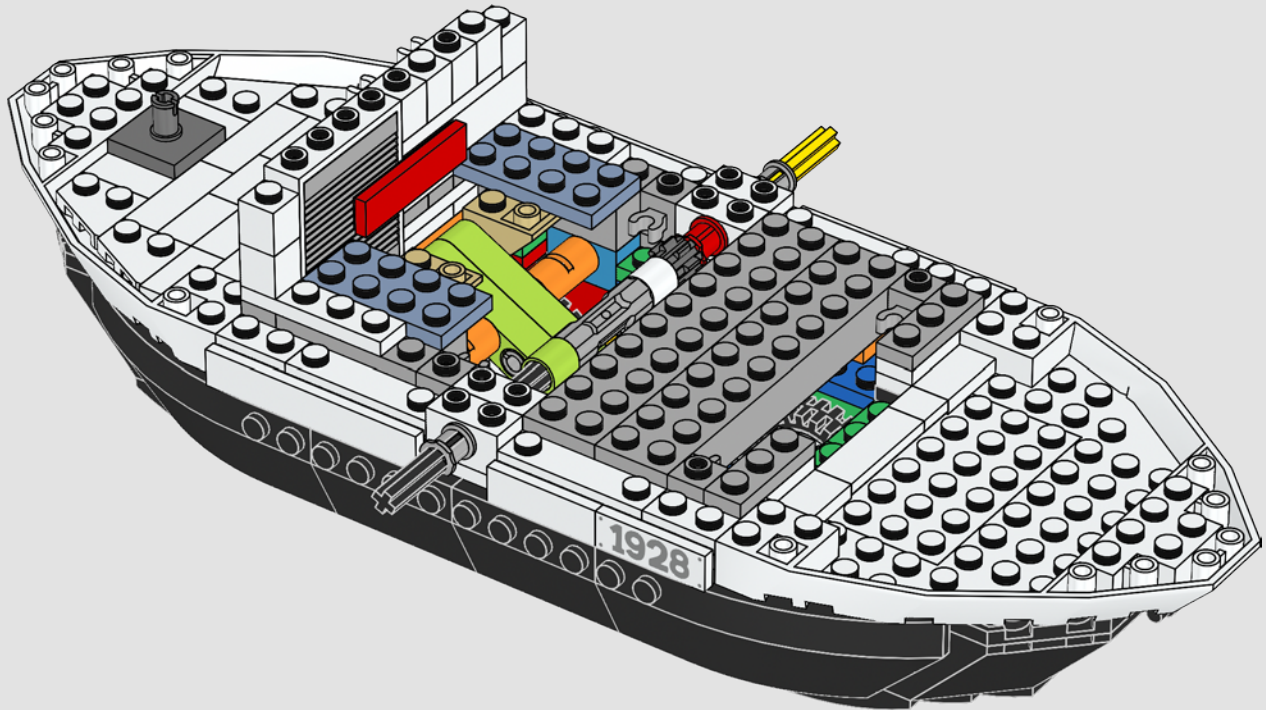

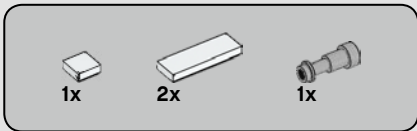

90

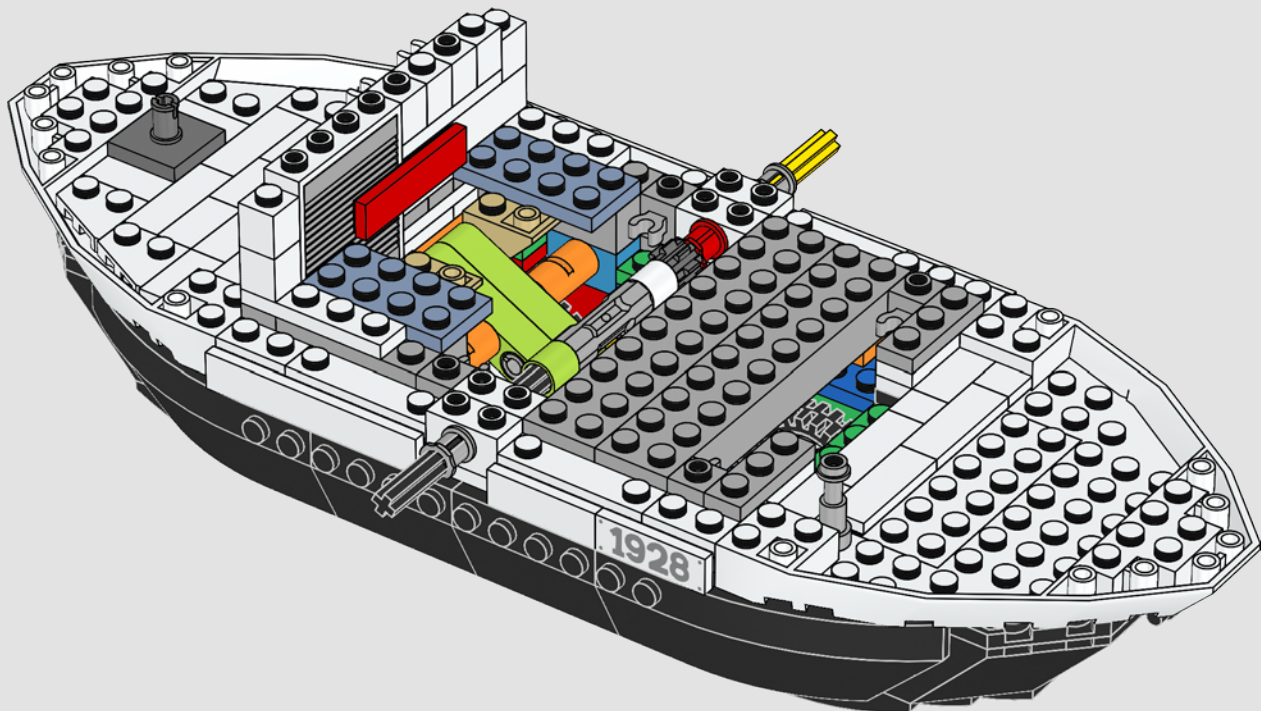

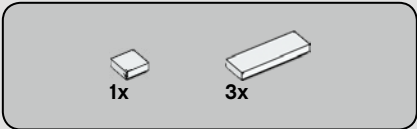

91

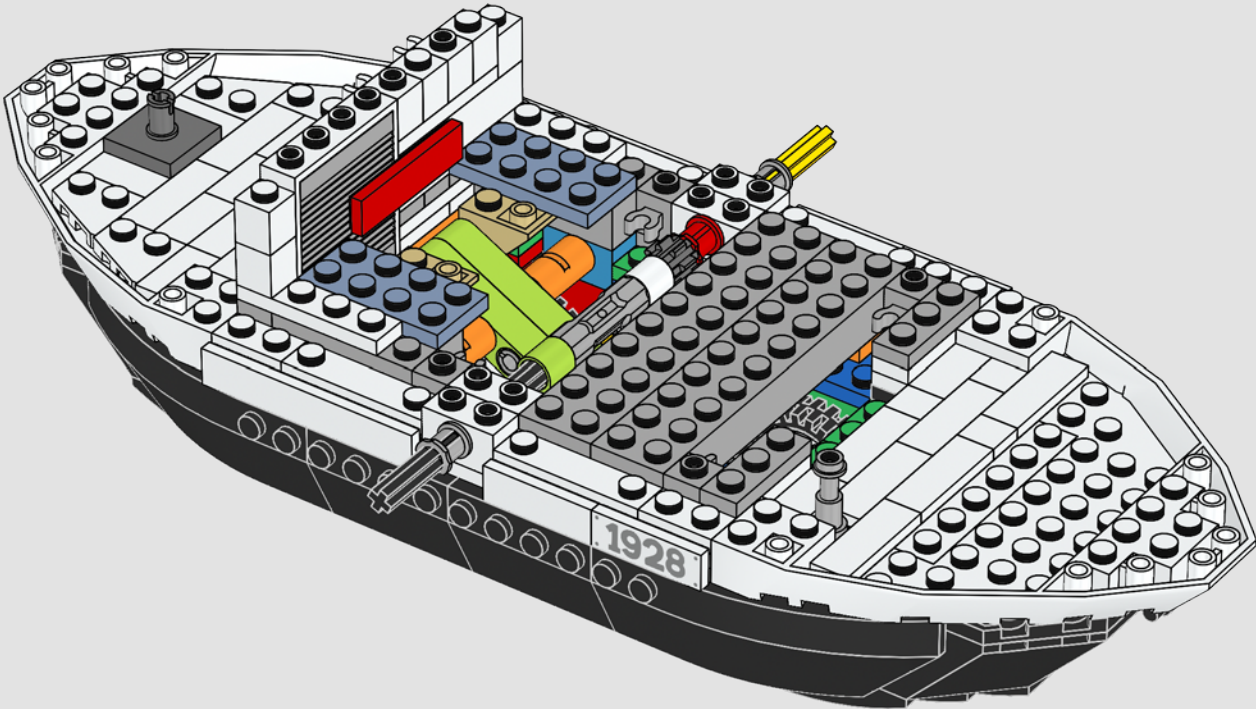

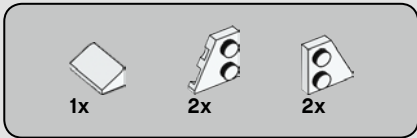

92

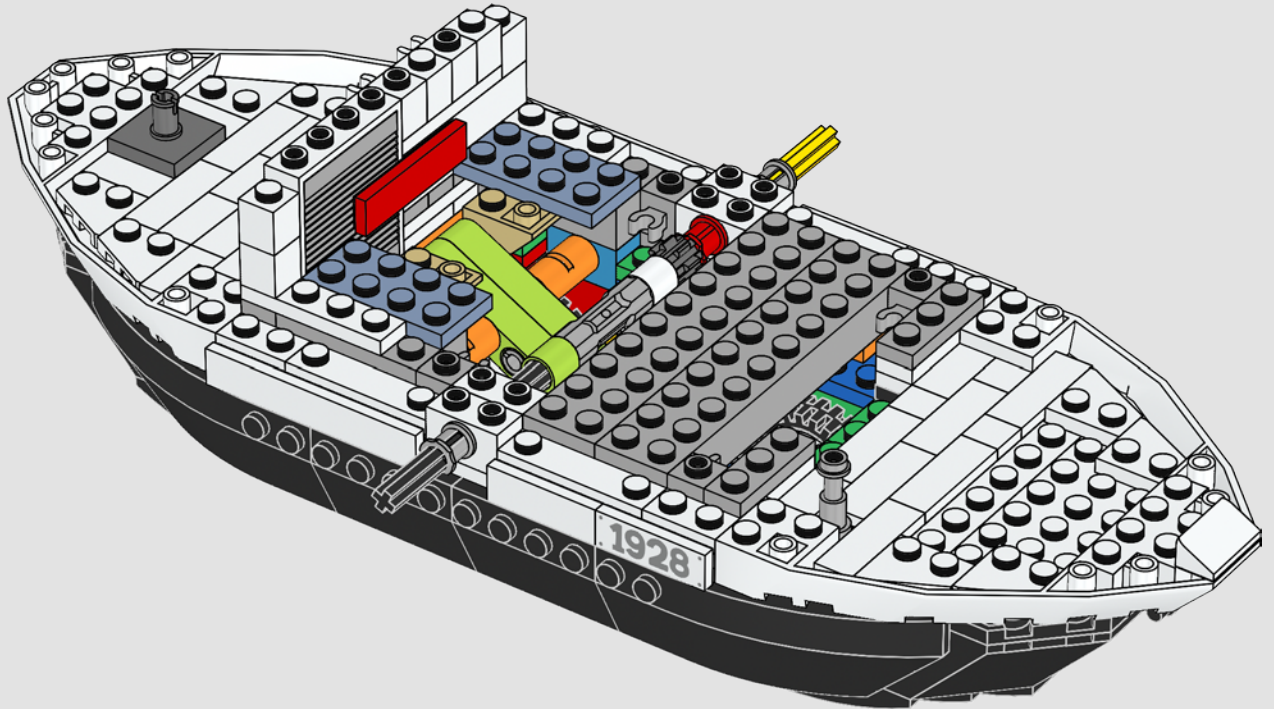

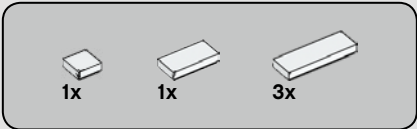

93

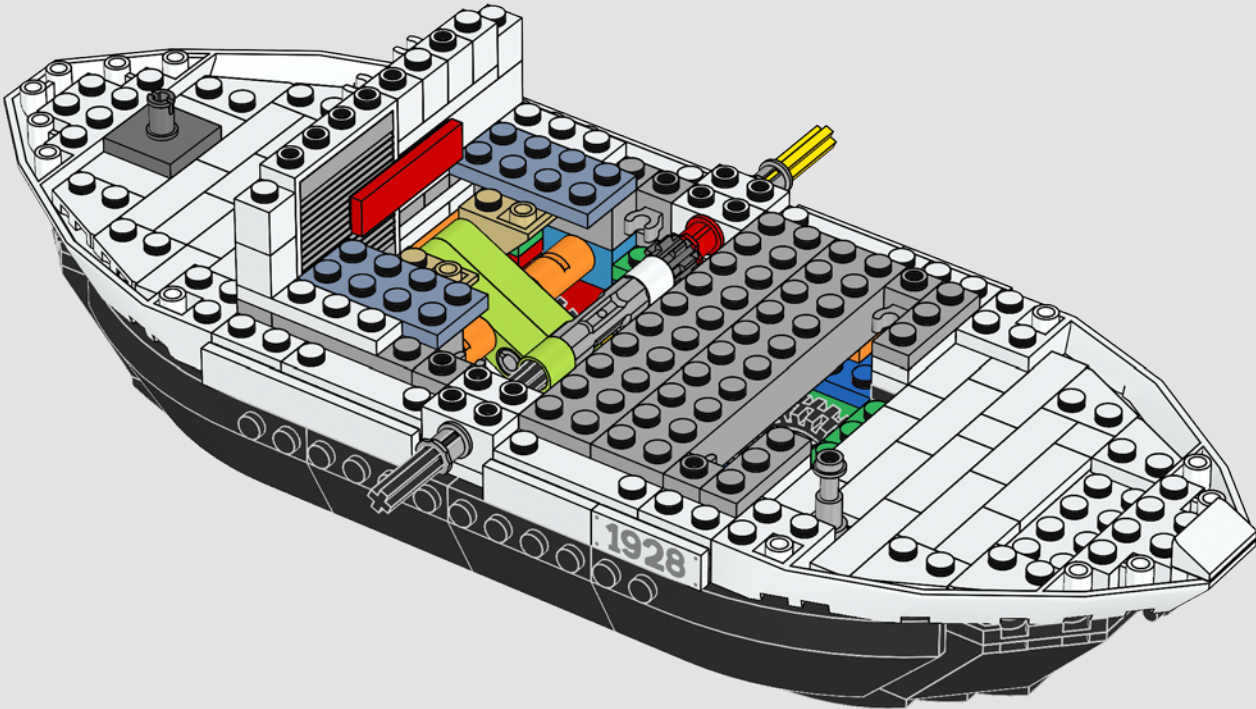

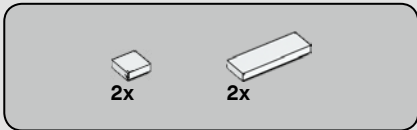

94

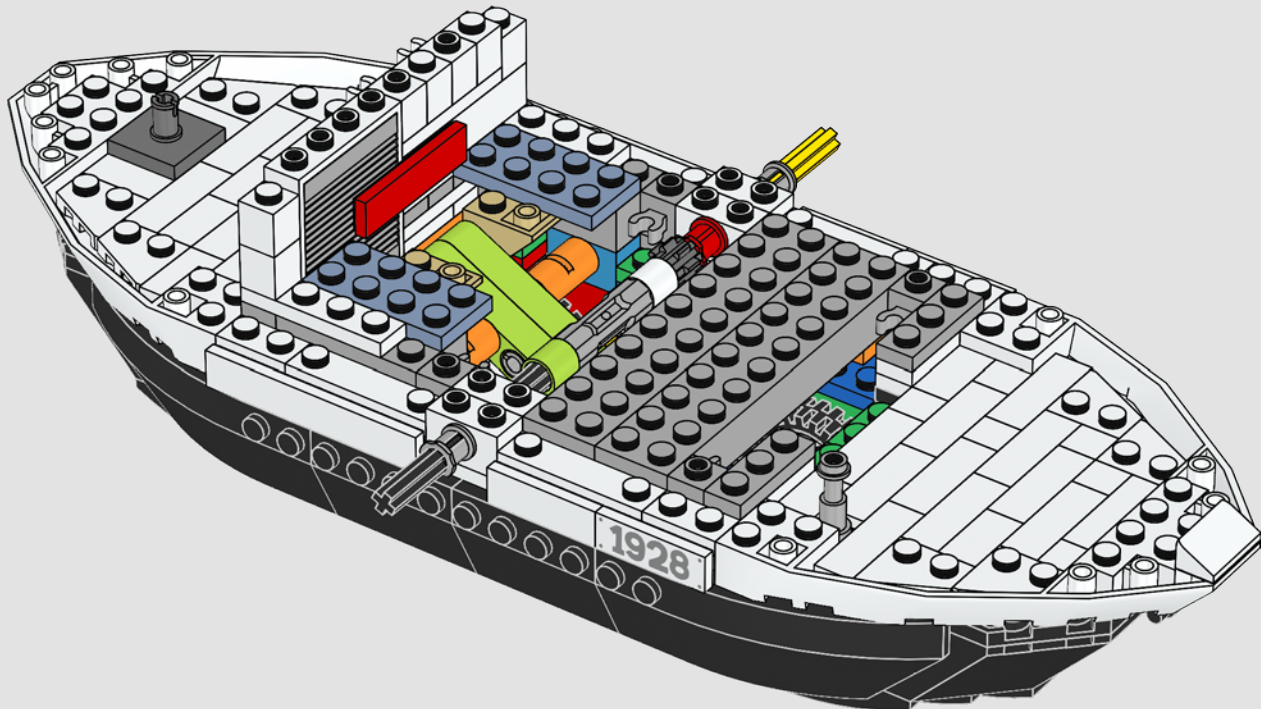



2x

95

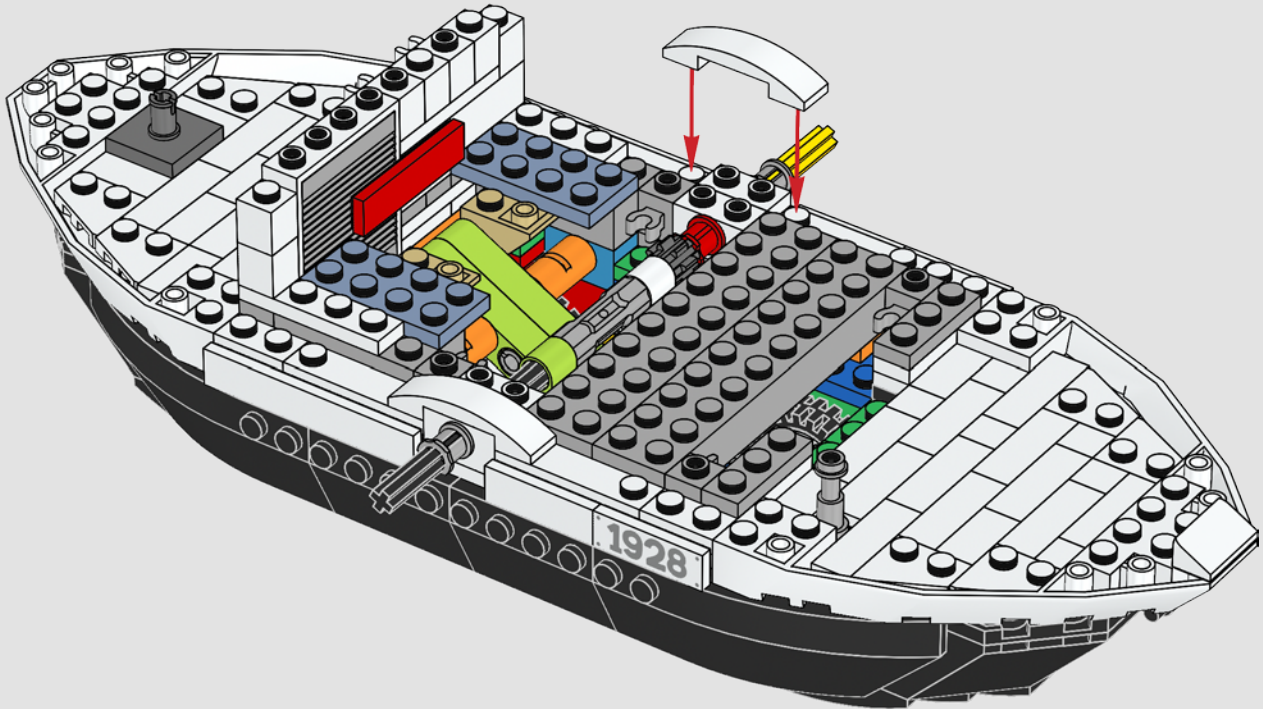

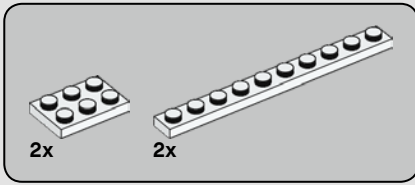

96

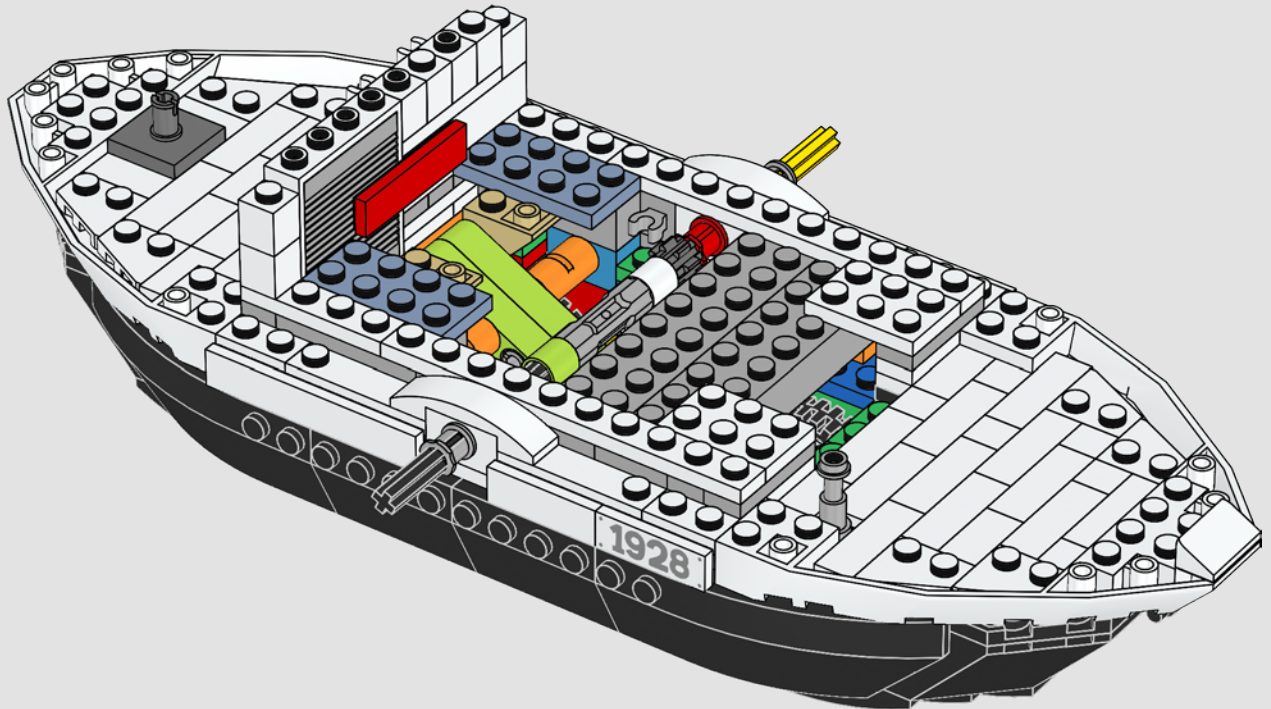



2x



2x

97

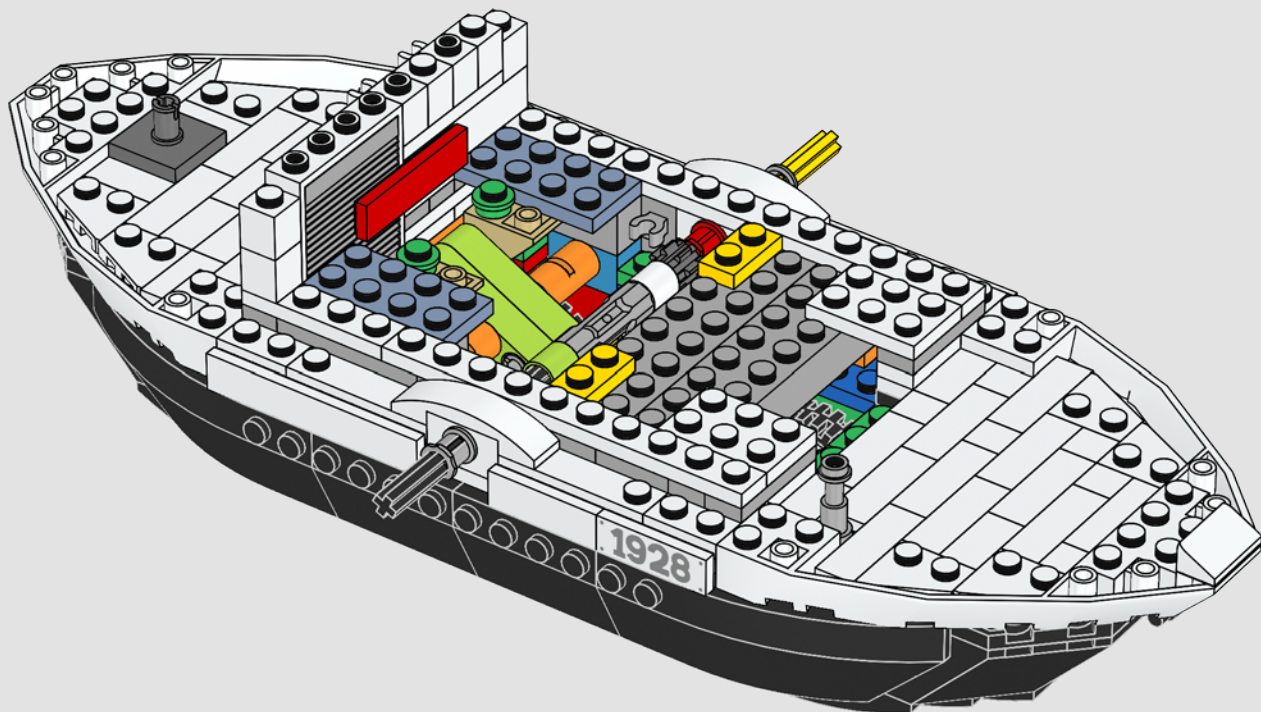

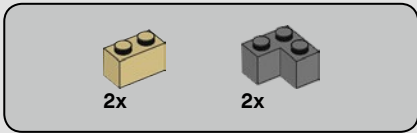

98

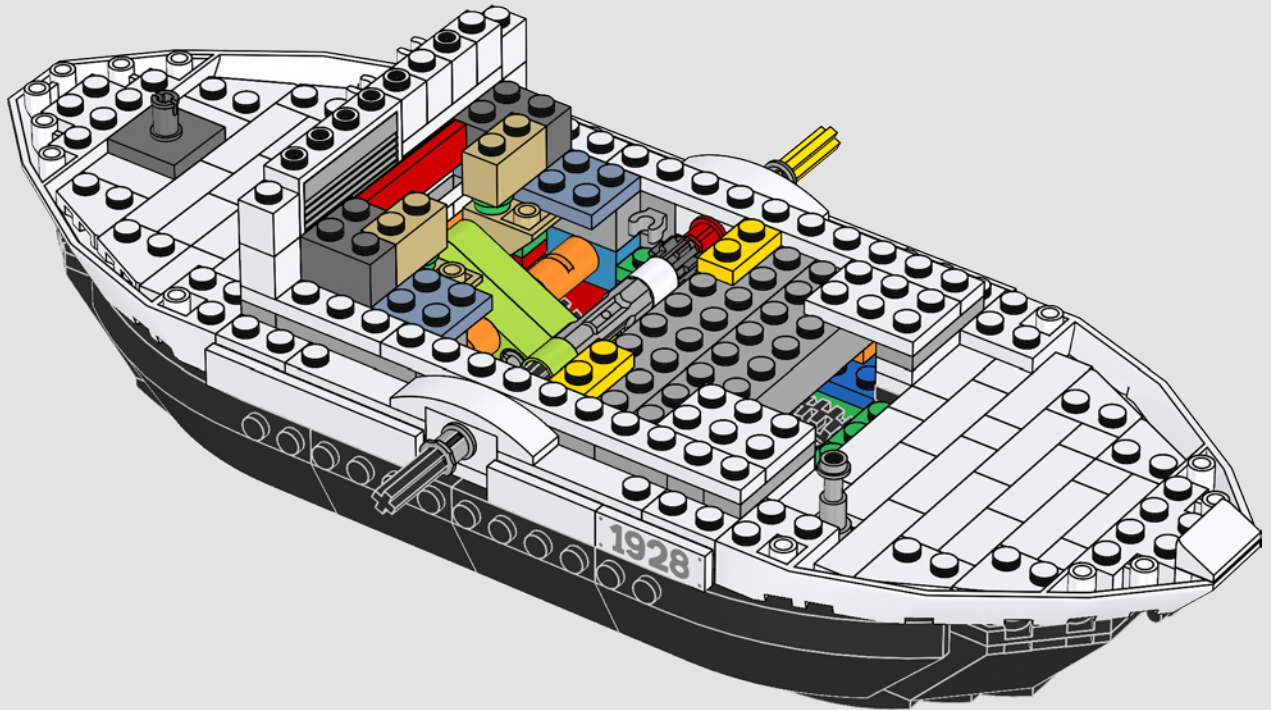

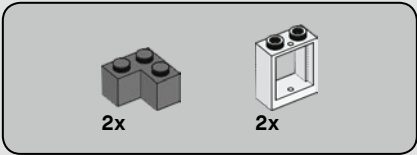

99

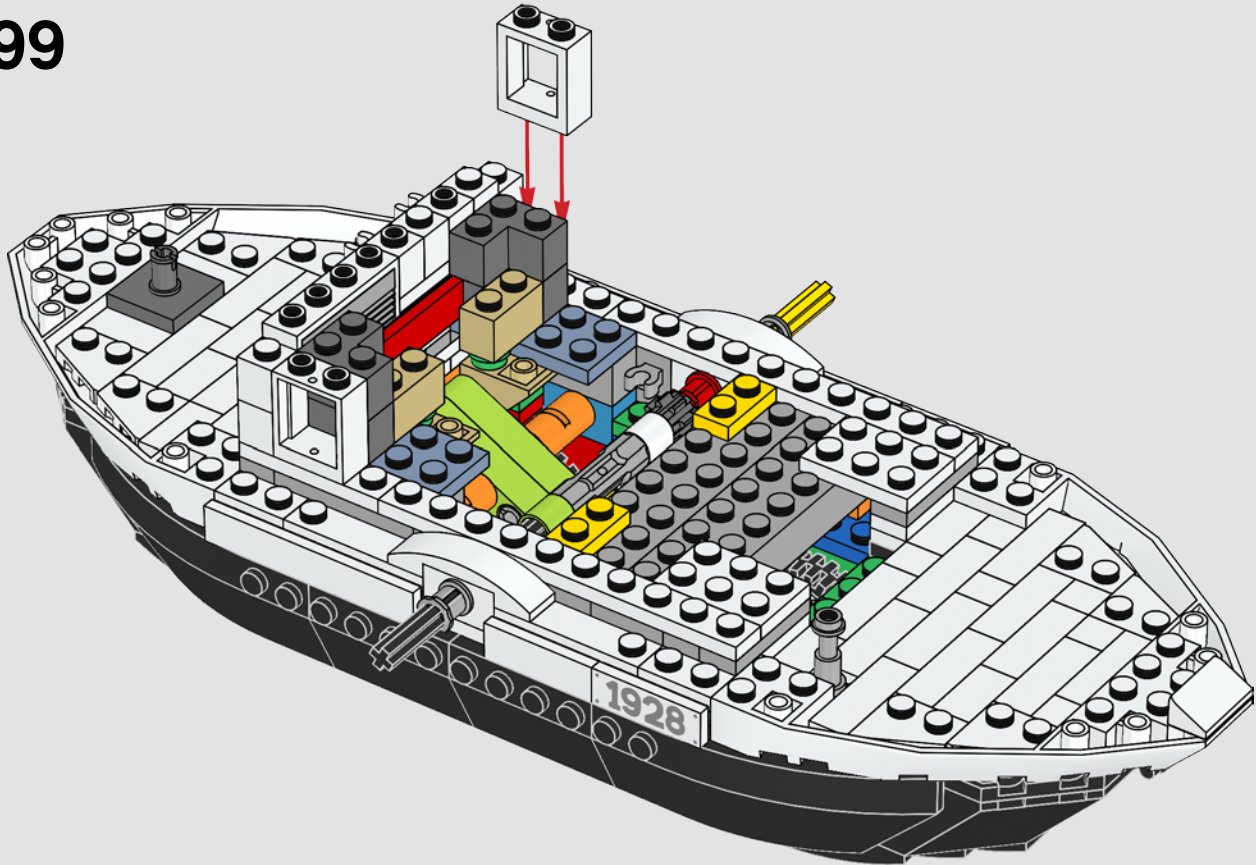

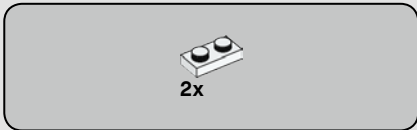

100

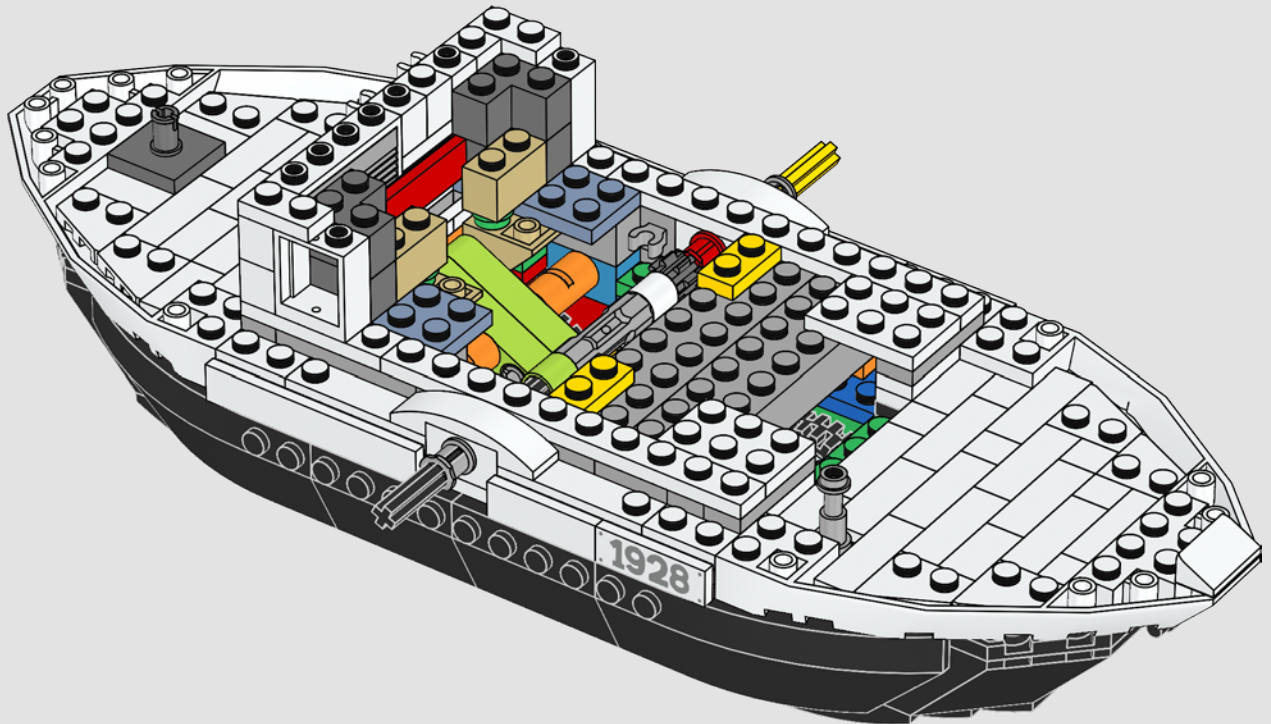

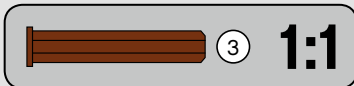
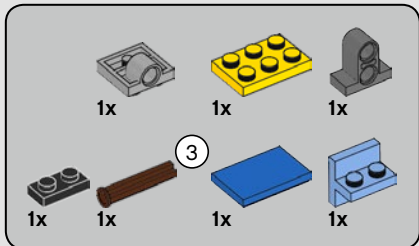

101

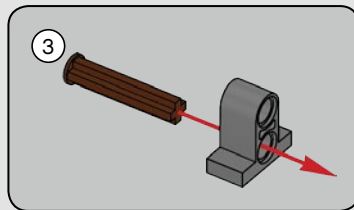

1



2

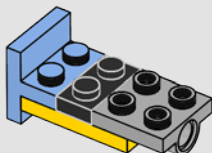

3

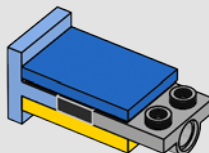

4

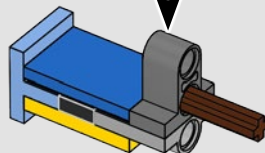

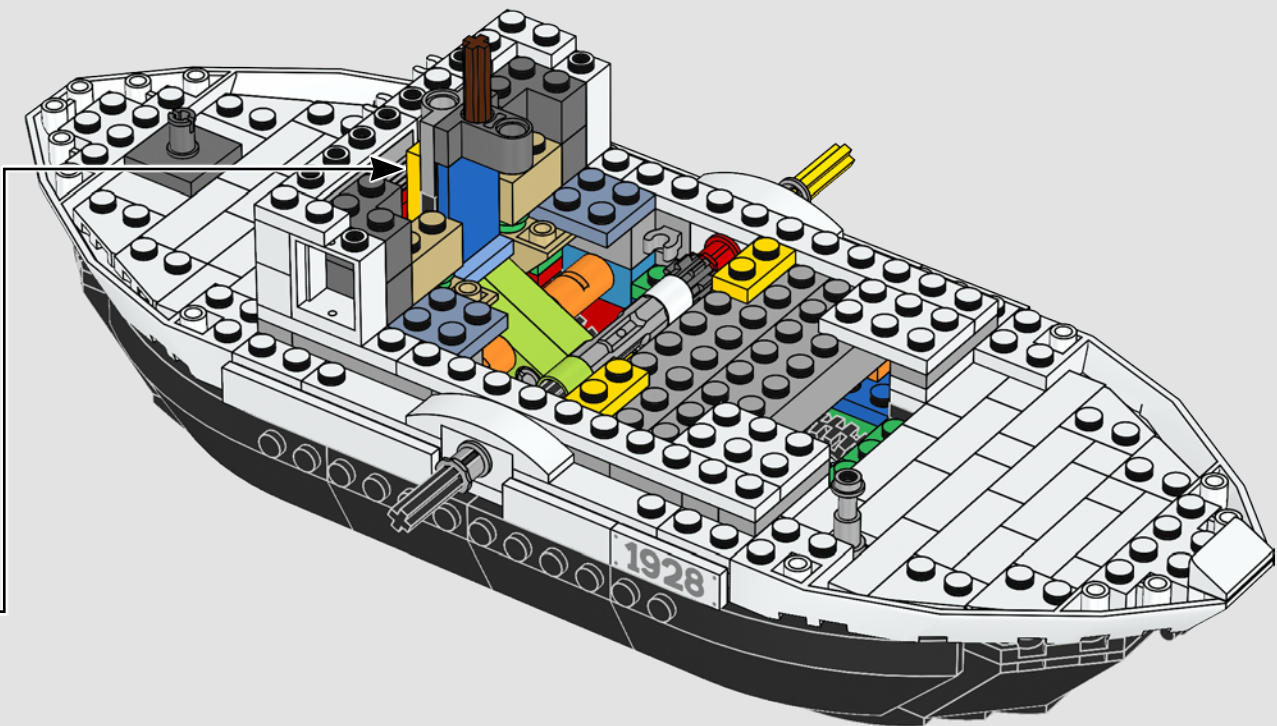

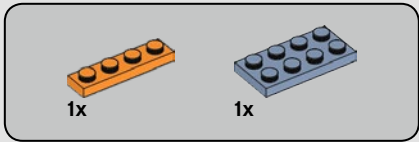

102

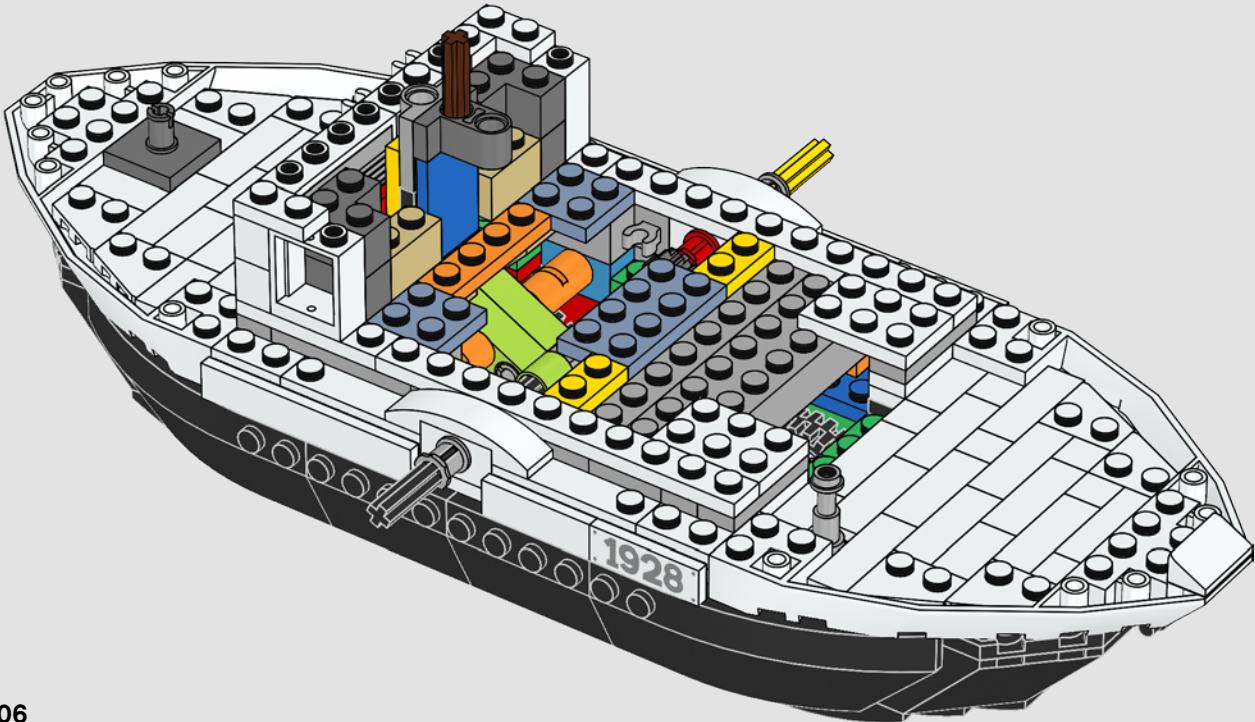

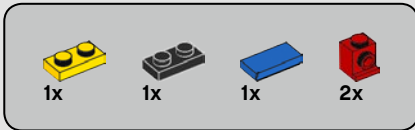

103

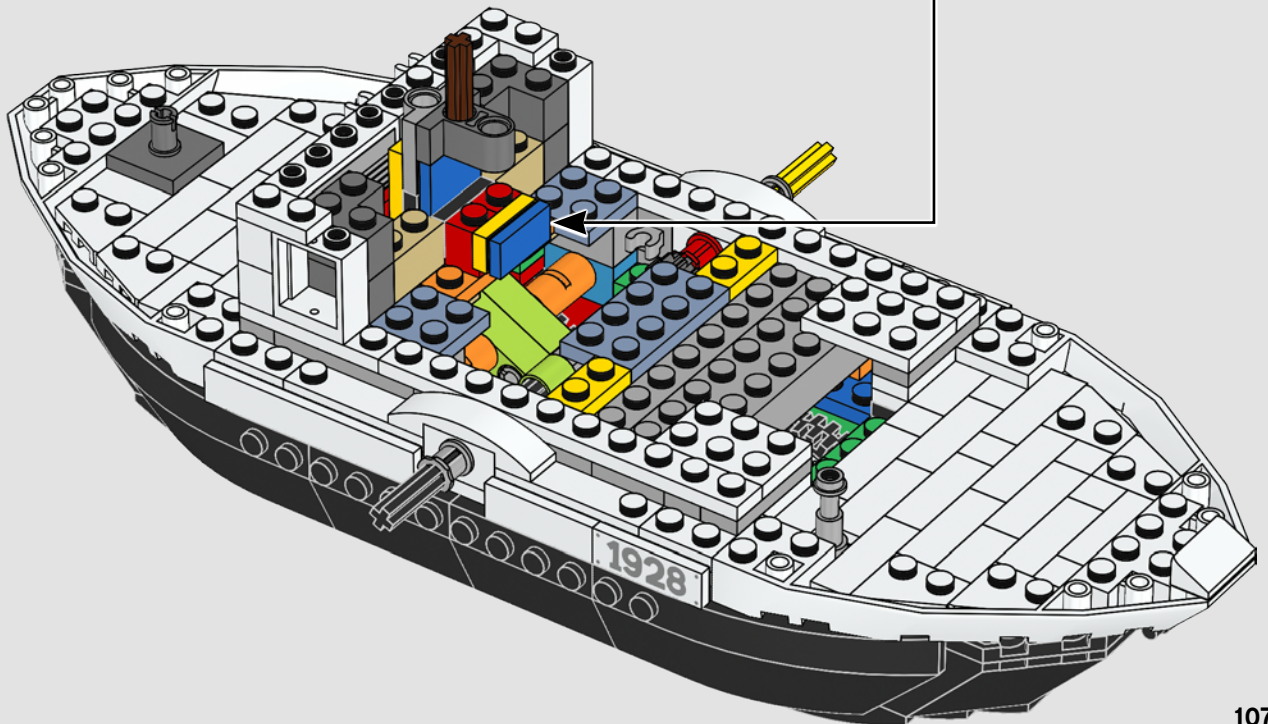
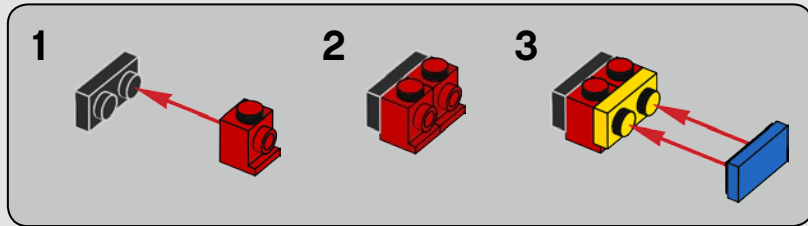

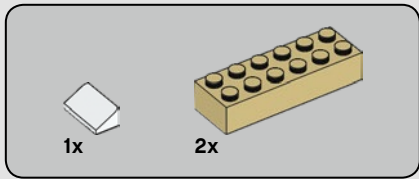

104

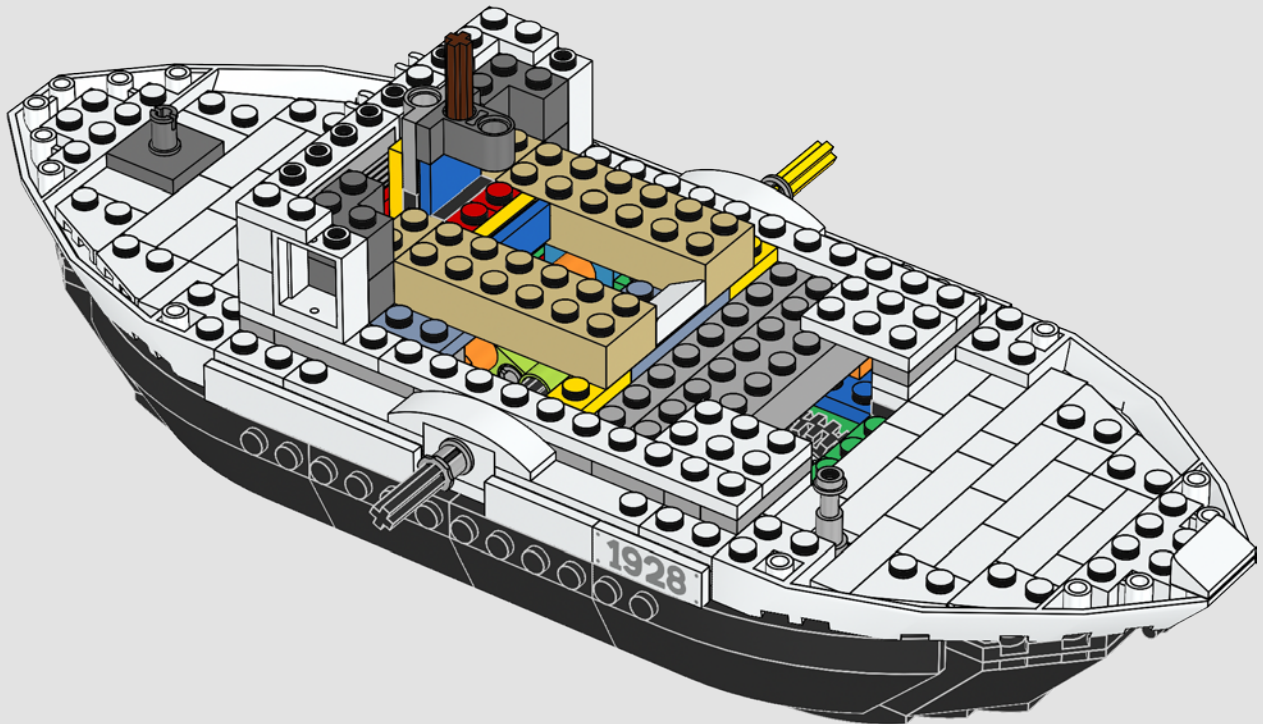

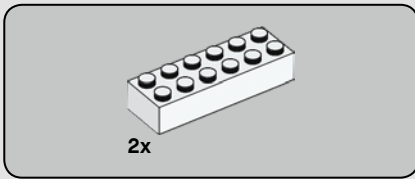

105

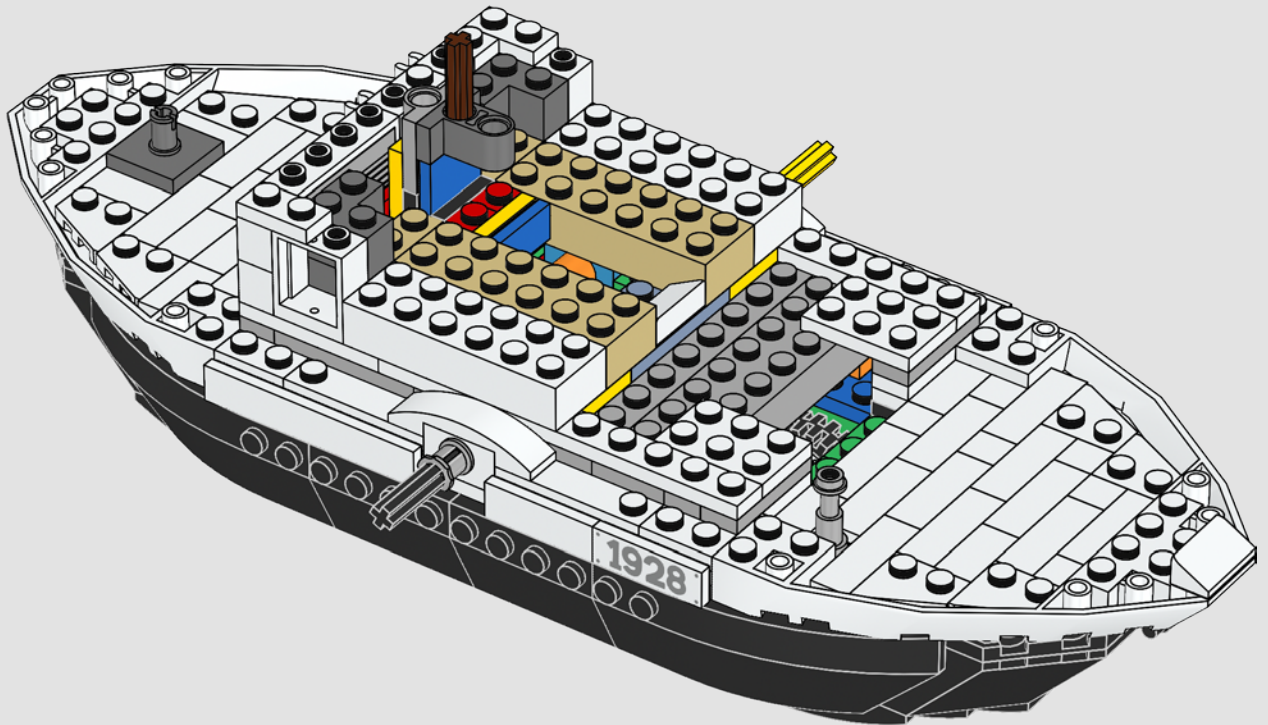

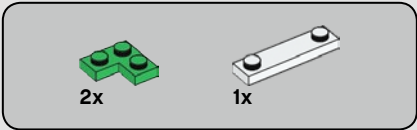

106

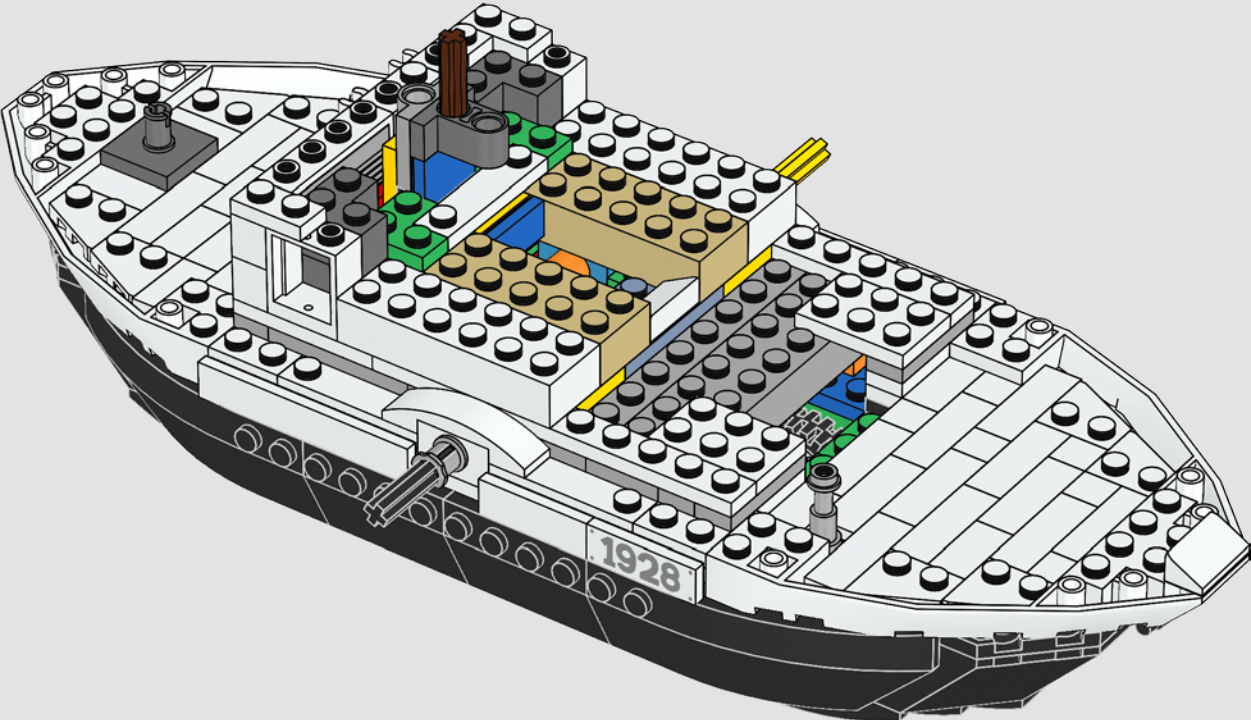

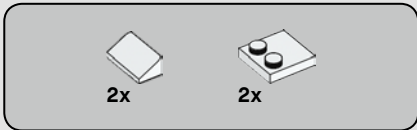

107

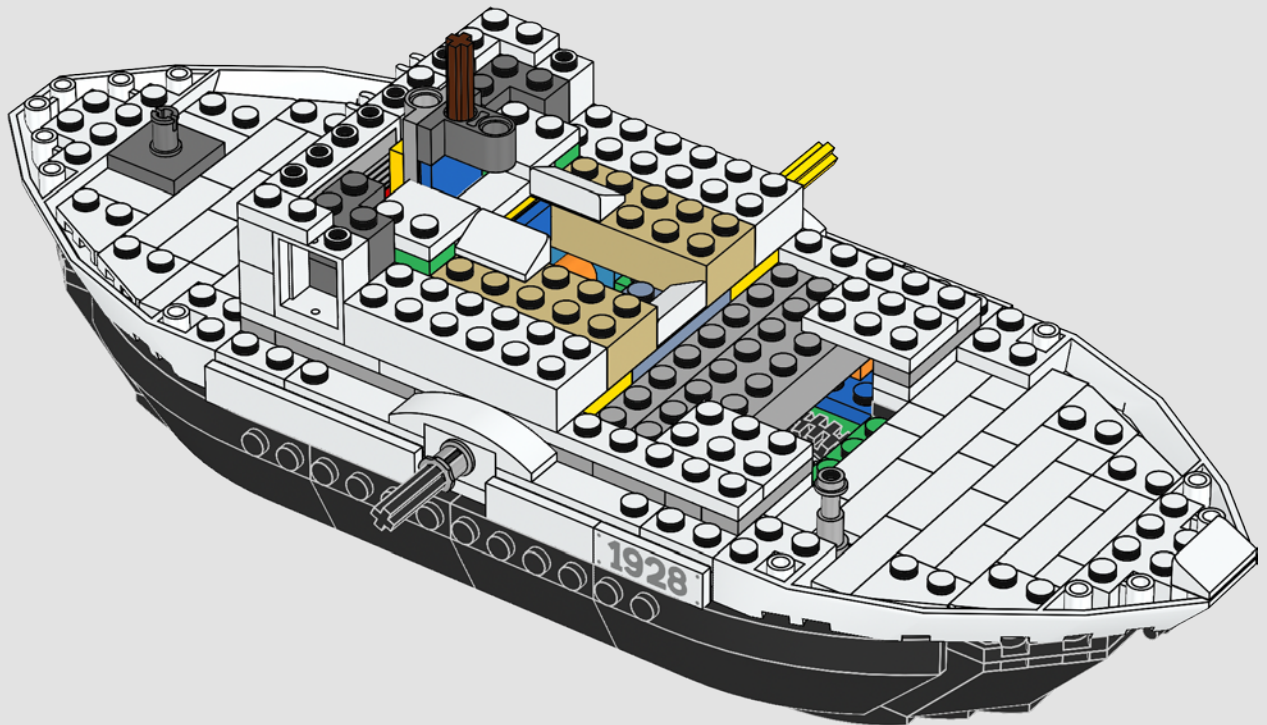

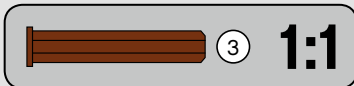
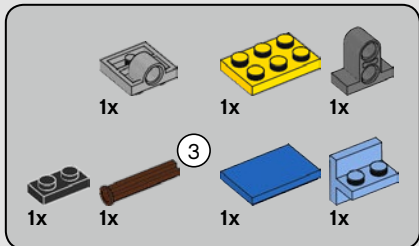

108

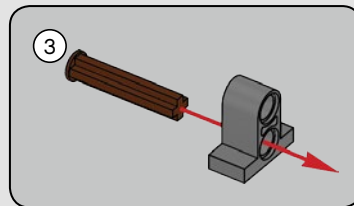

1



2

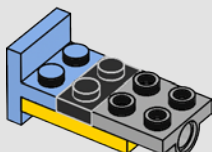

3

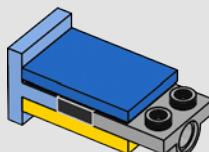

4

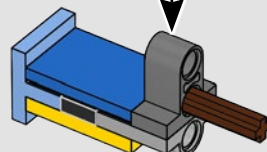

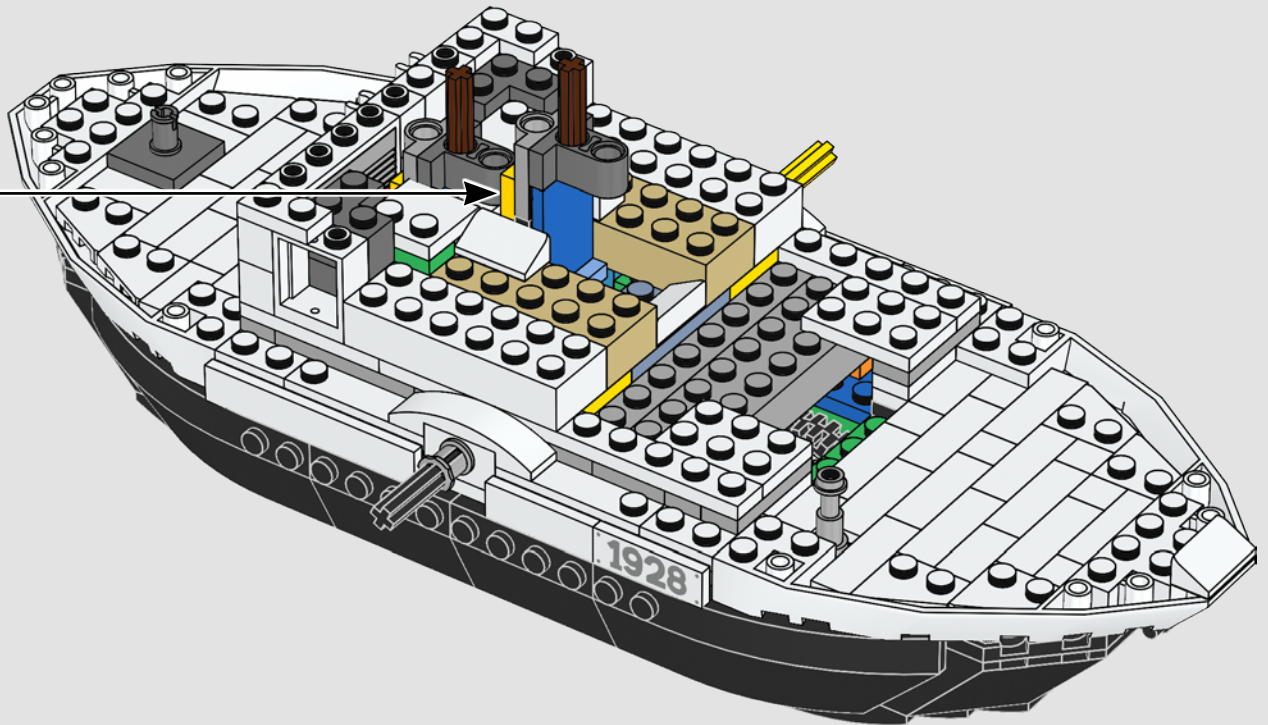

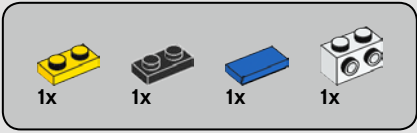

109

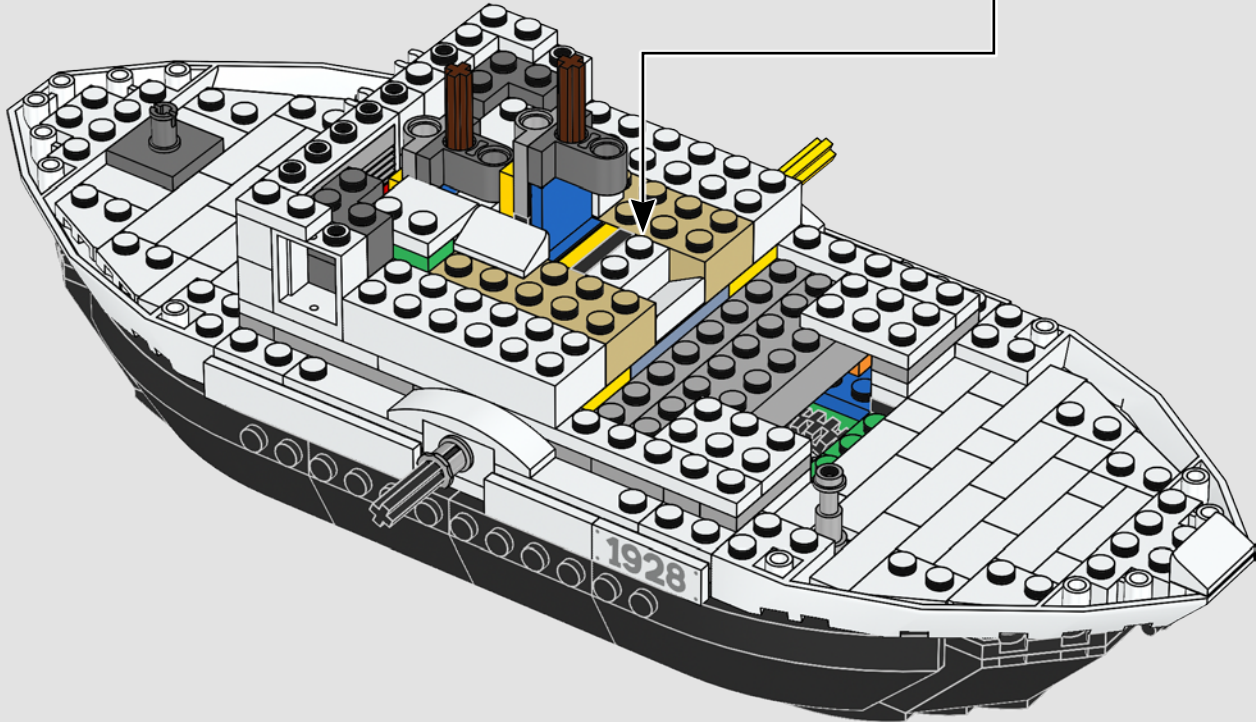
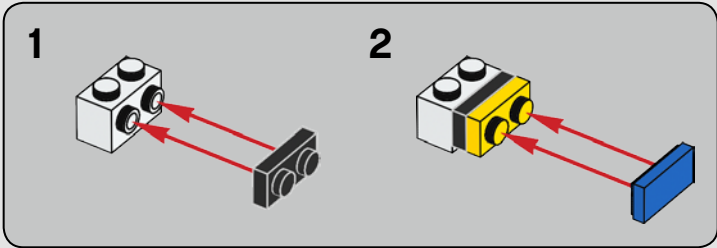

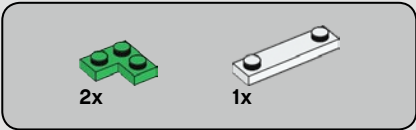

110

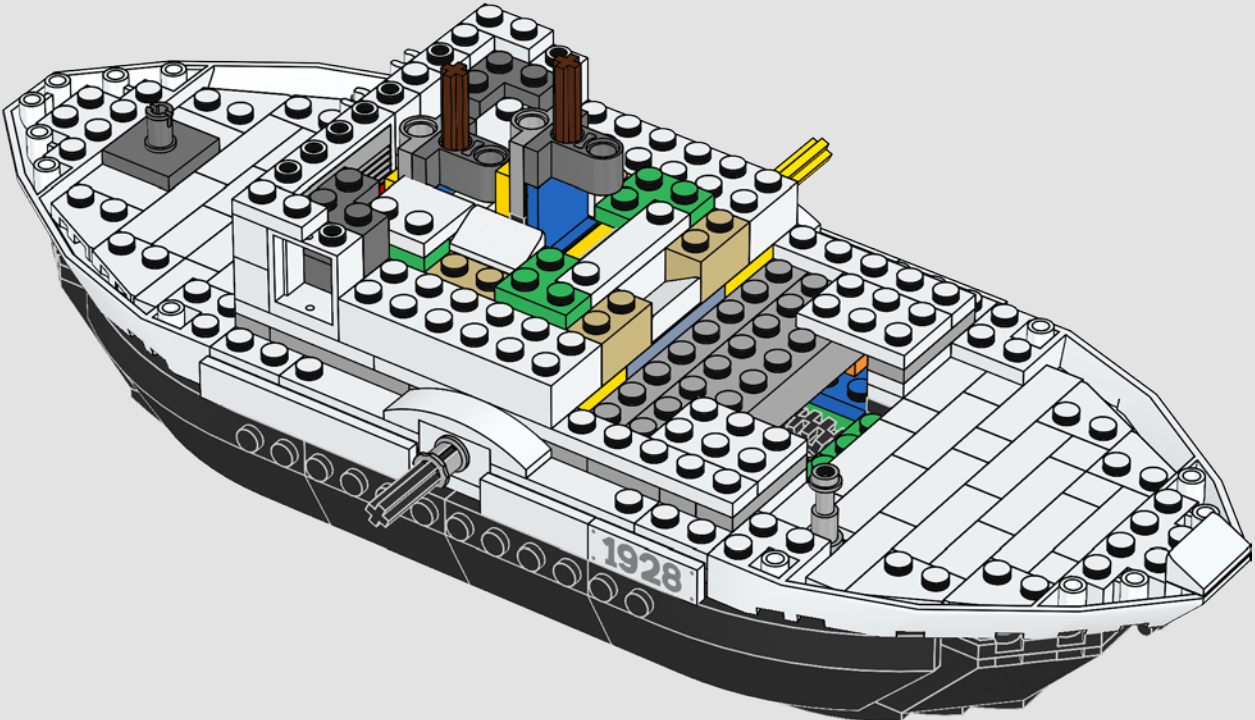



2x

111

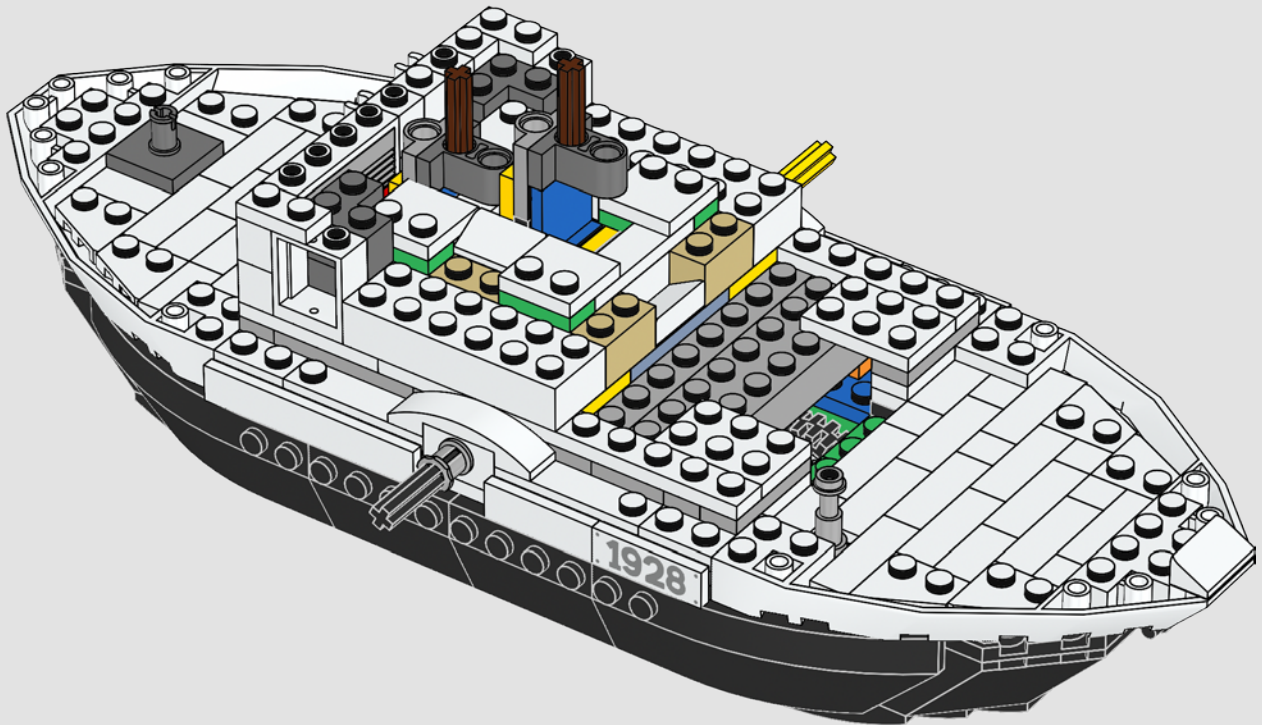

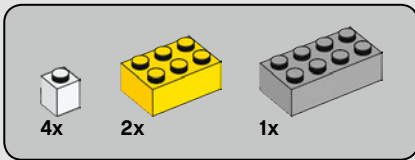

112

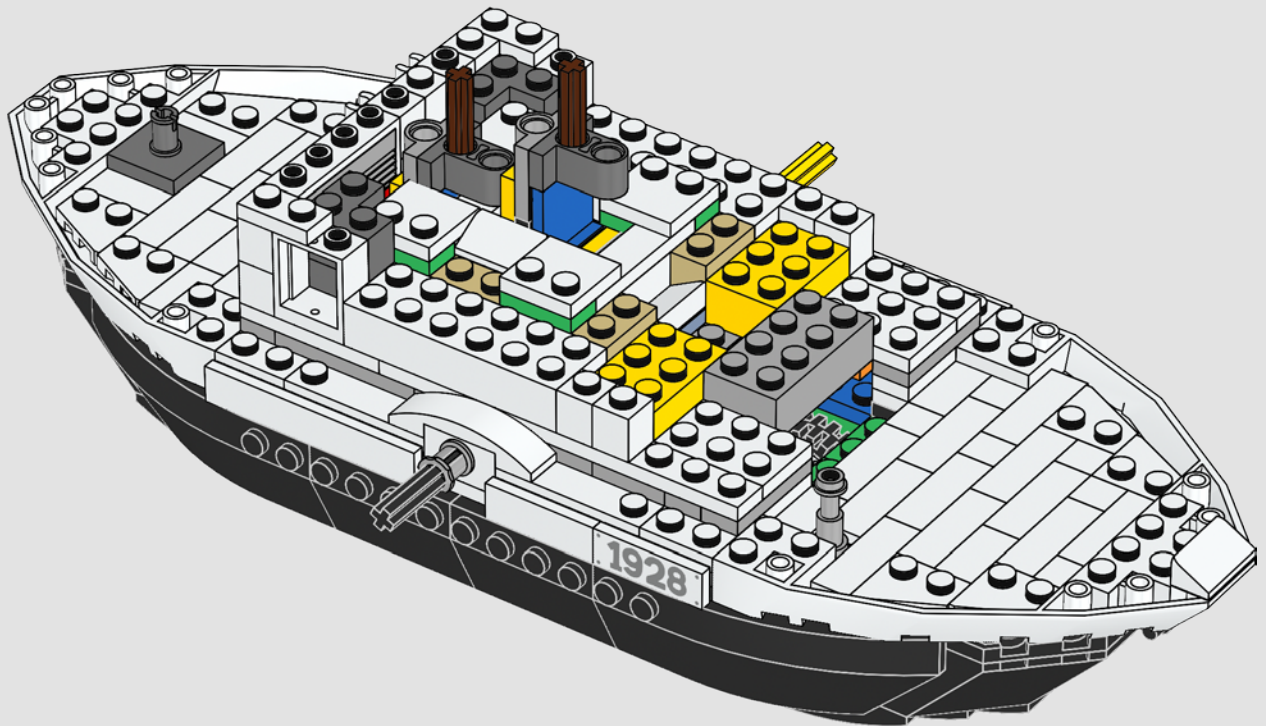

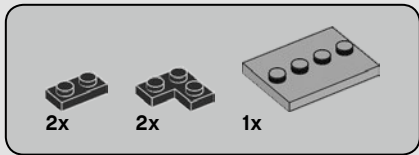

113

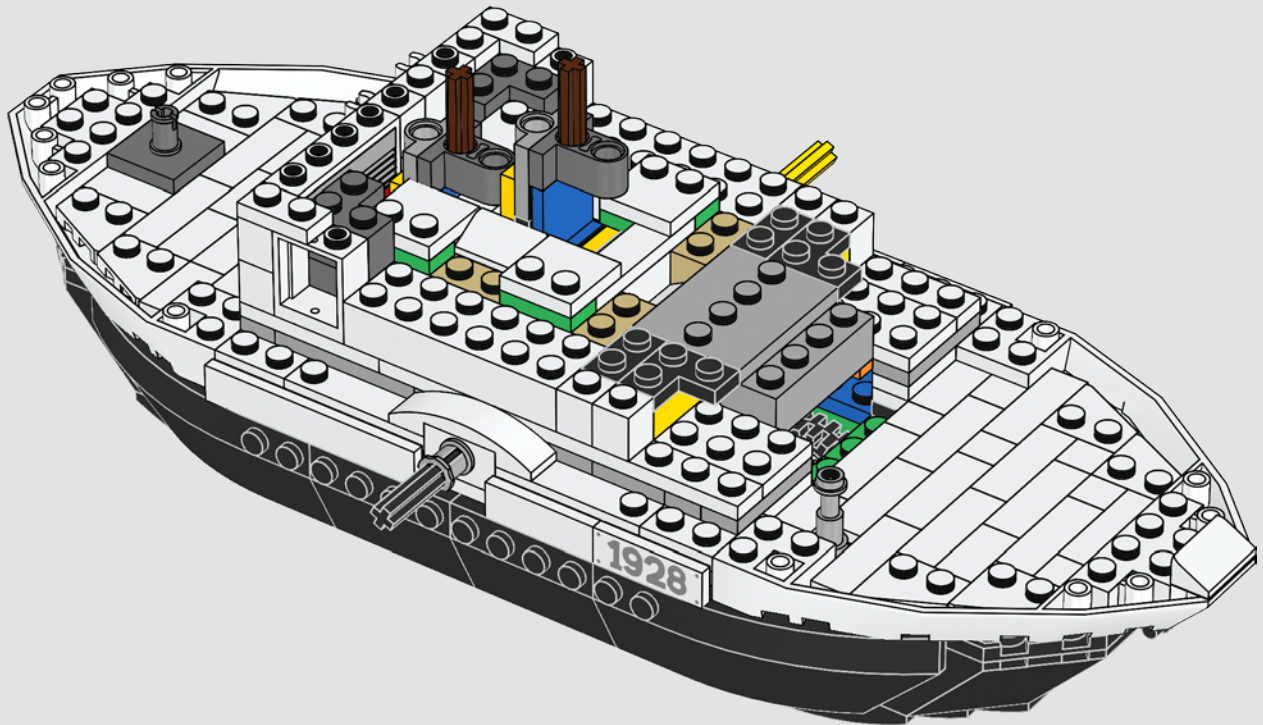

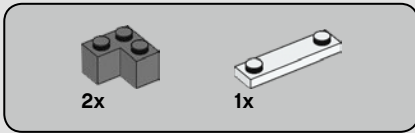

114

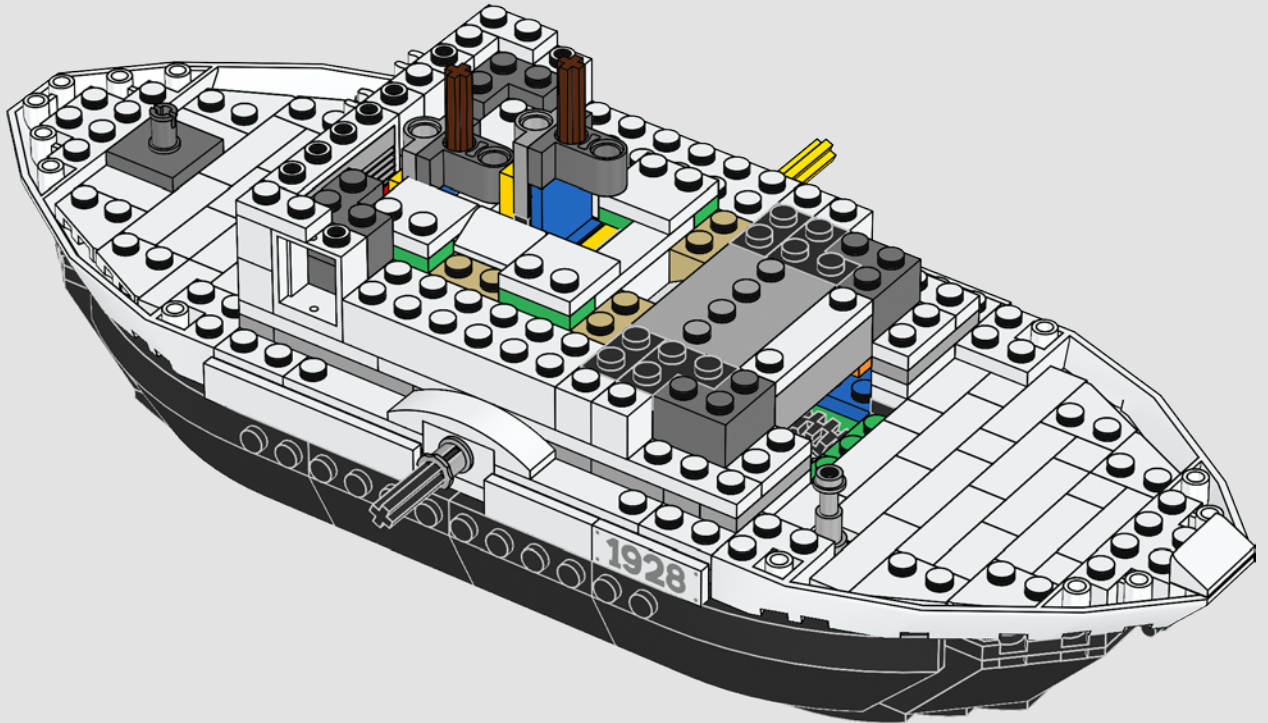

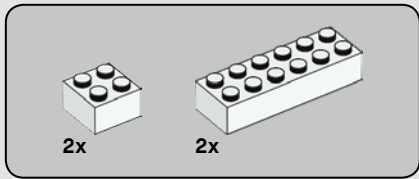

115

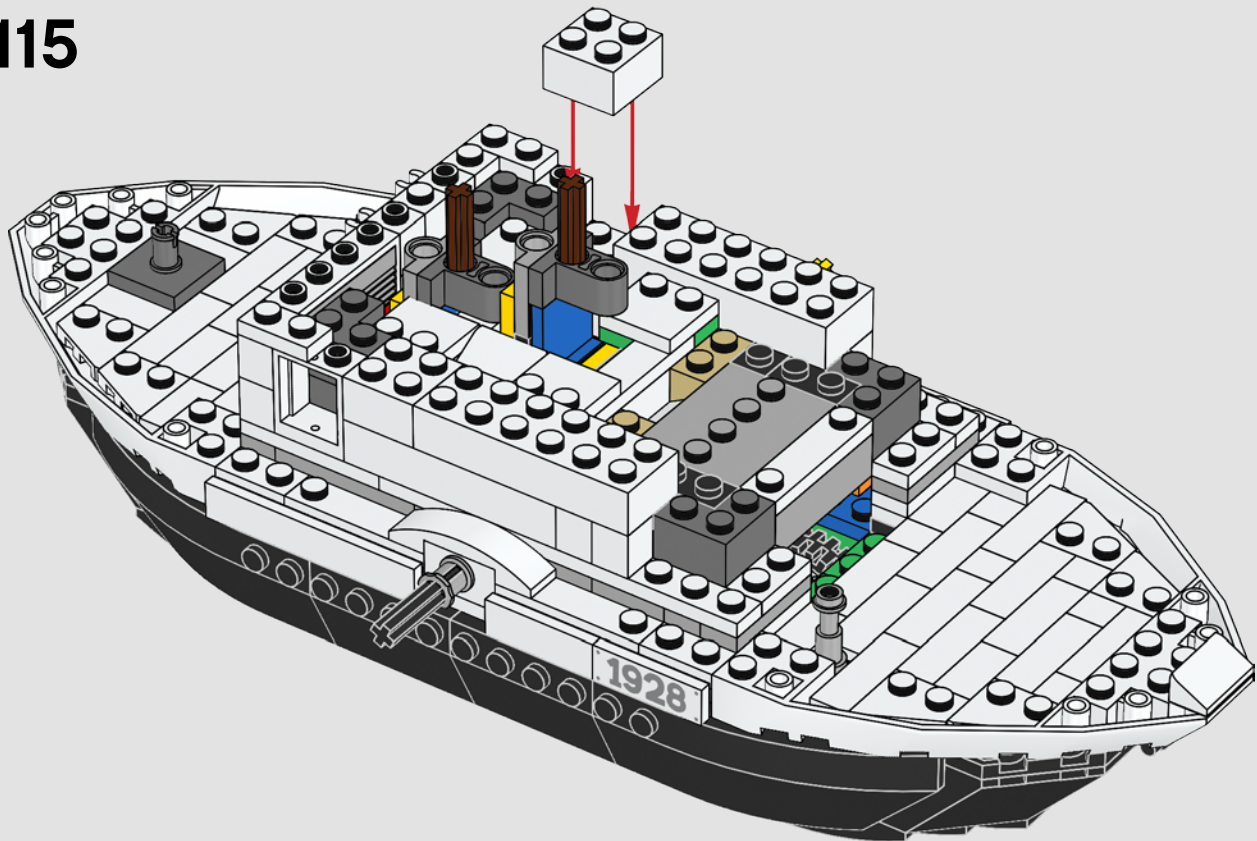

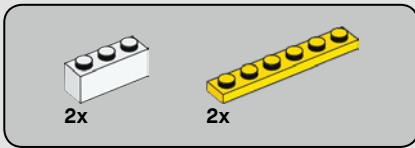

116

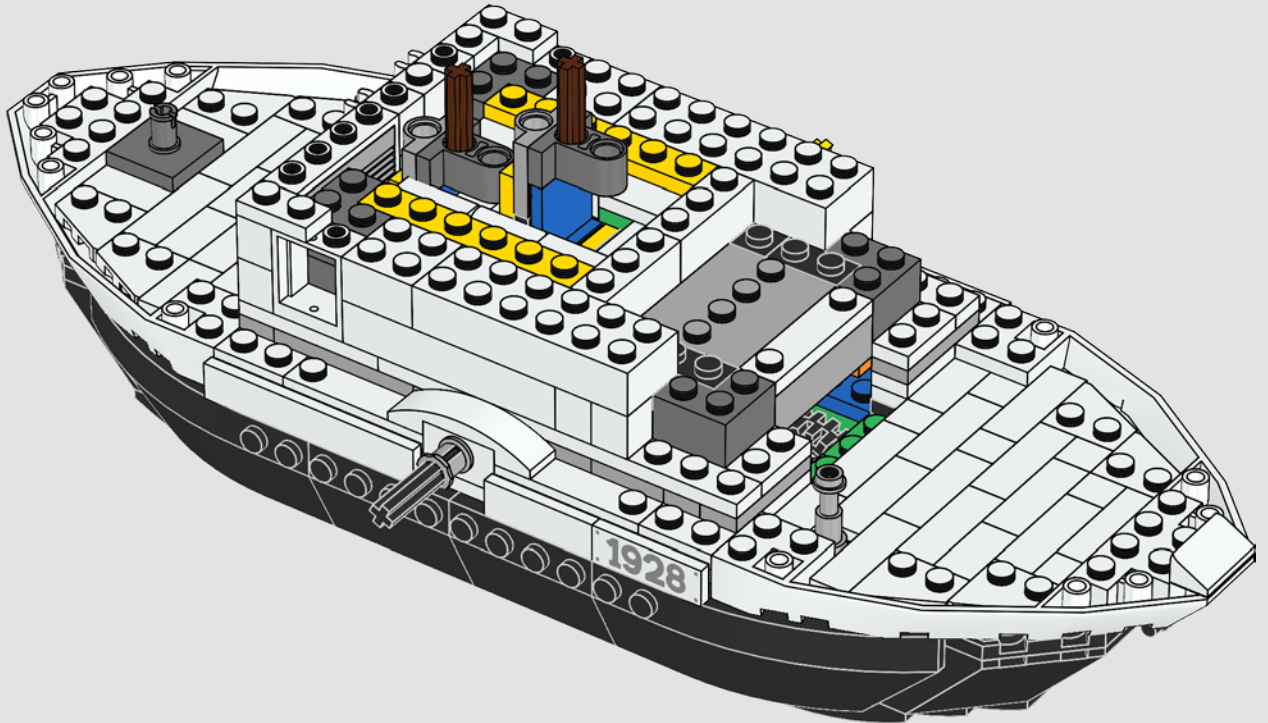



2x



2x

117

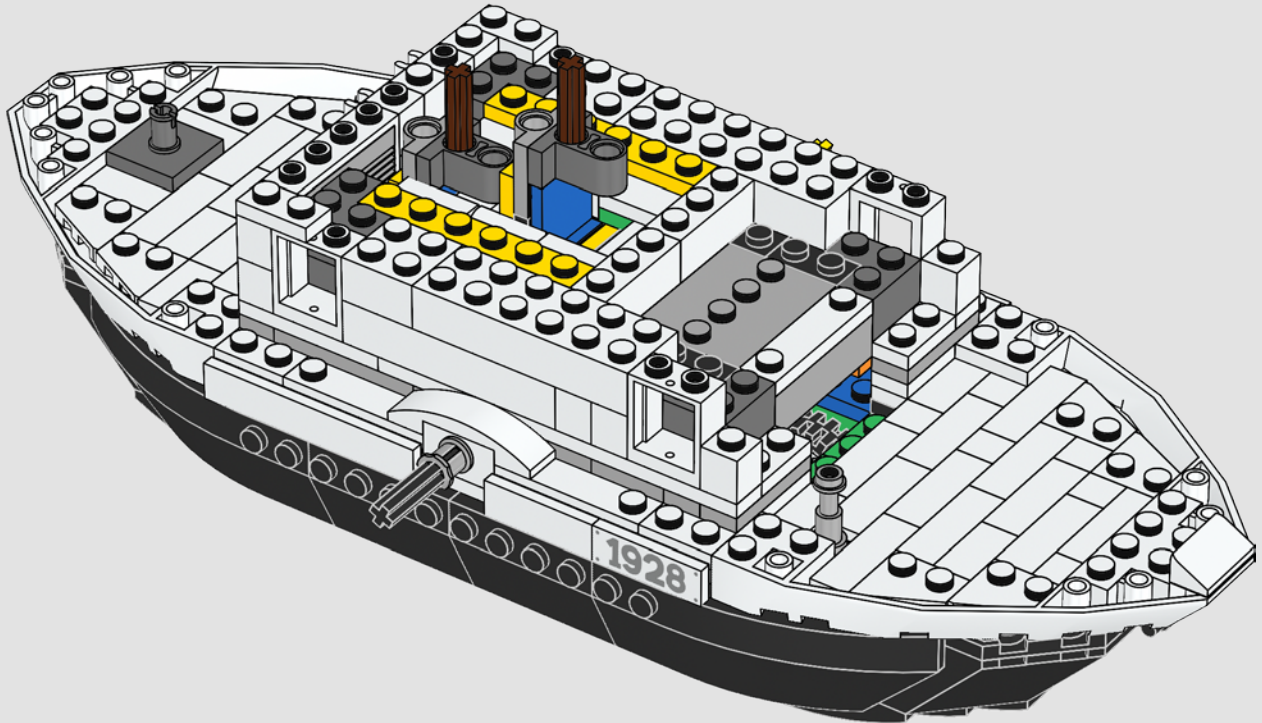

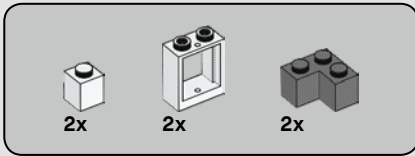

118

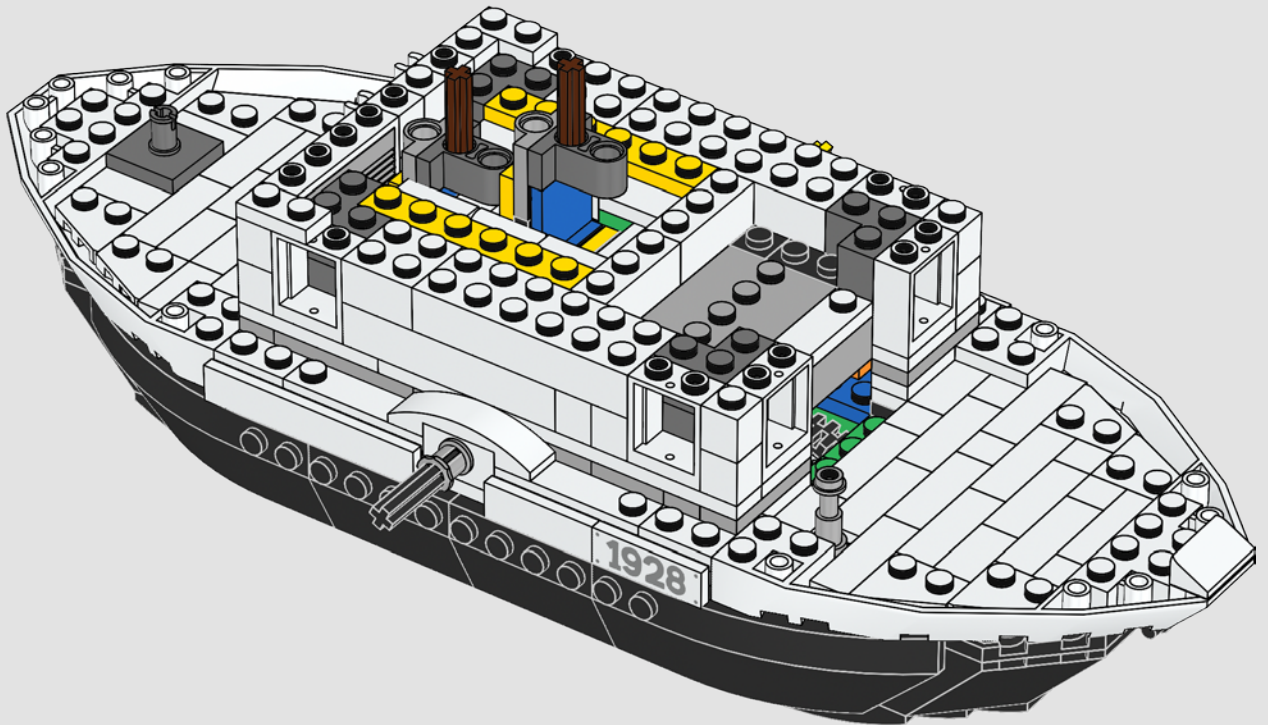

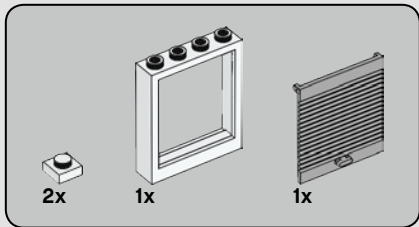

119

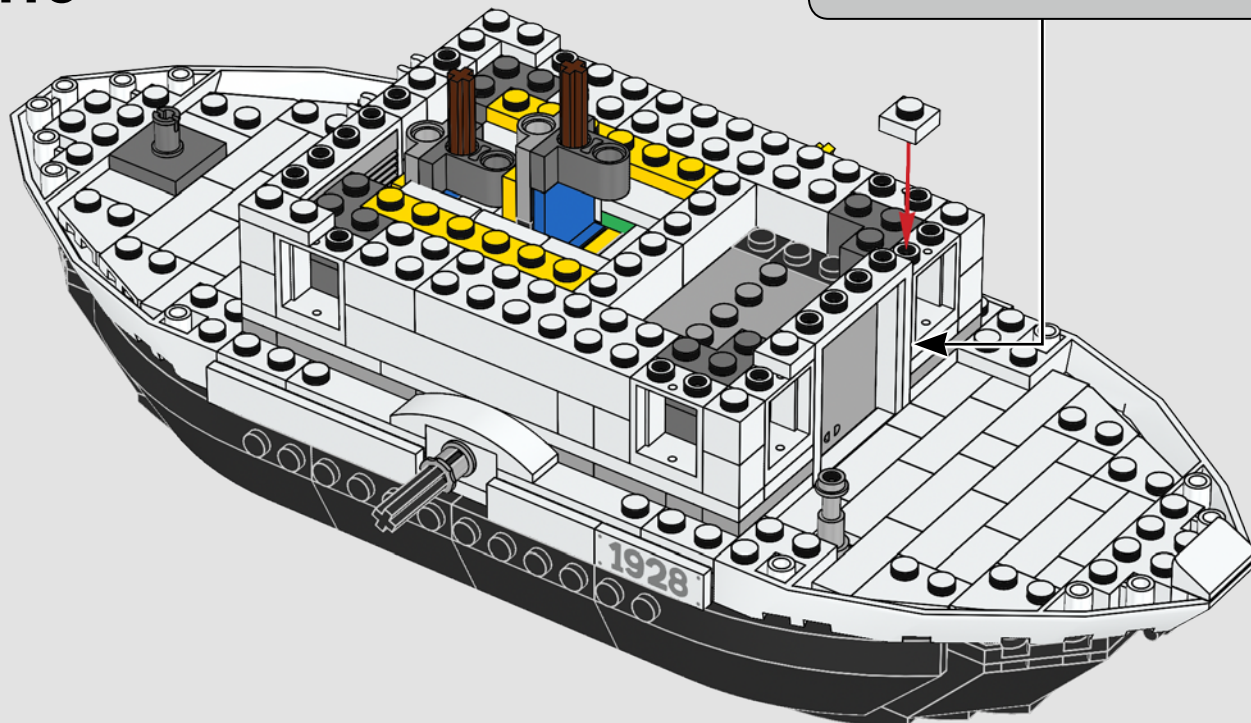
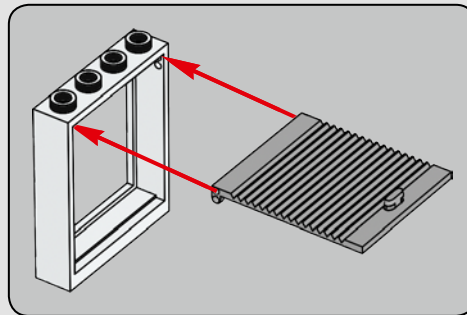

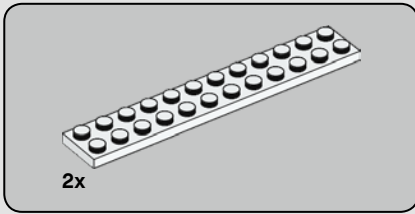

120

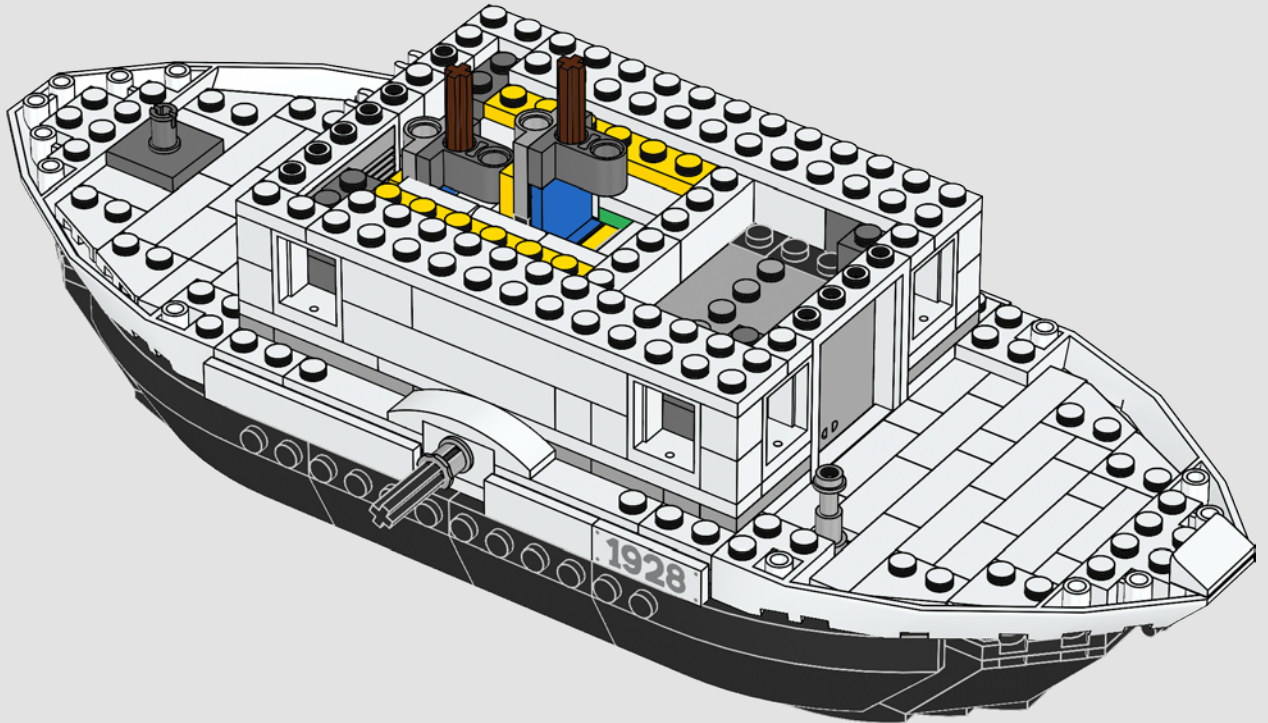

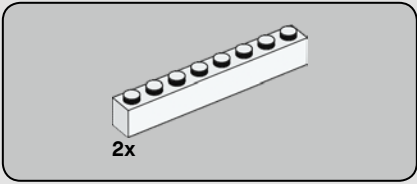

121

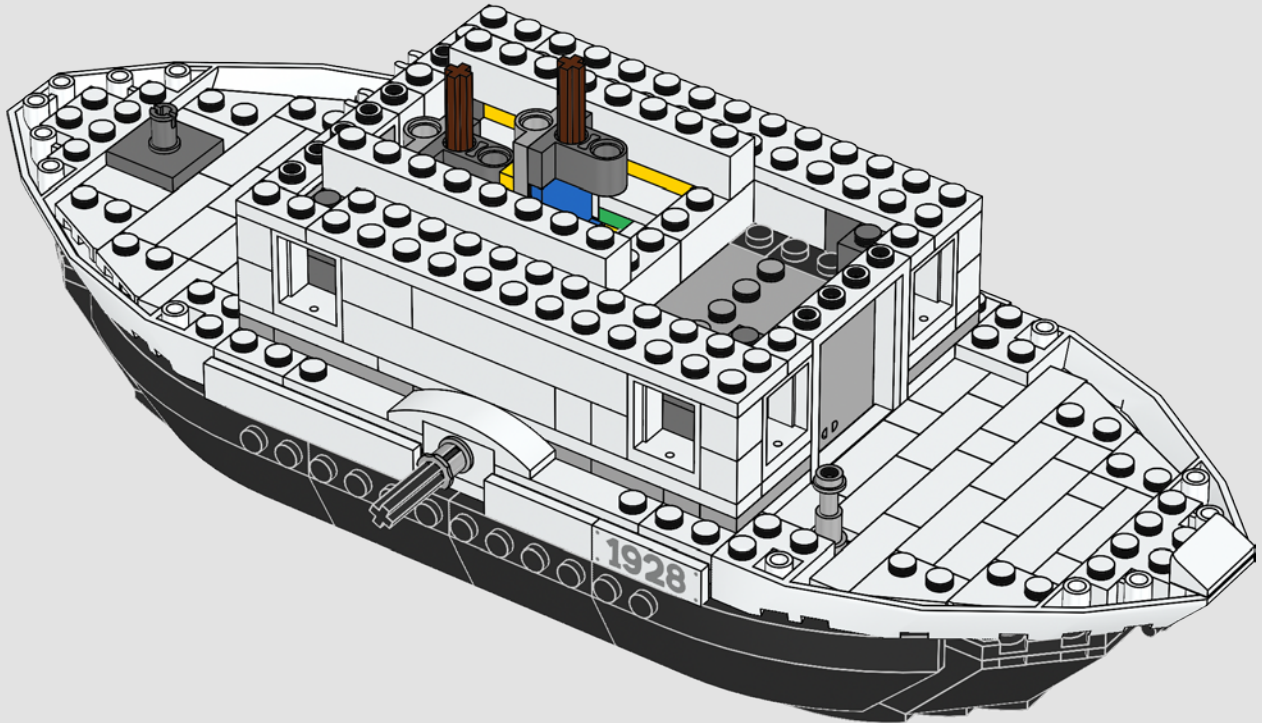

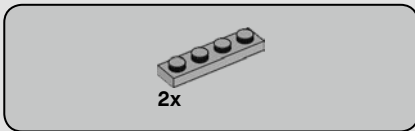

122

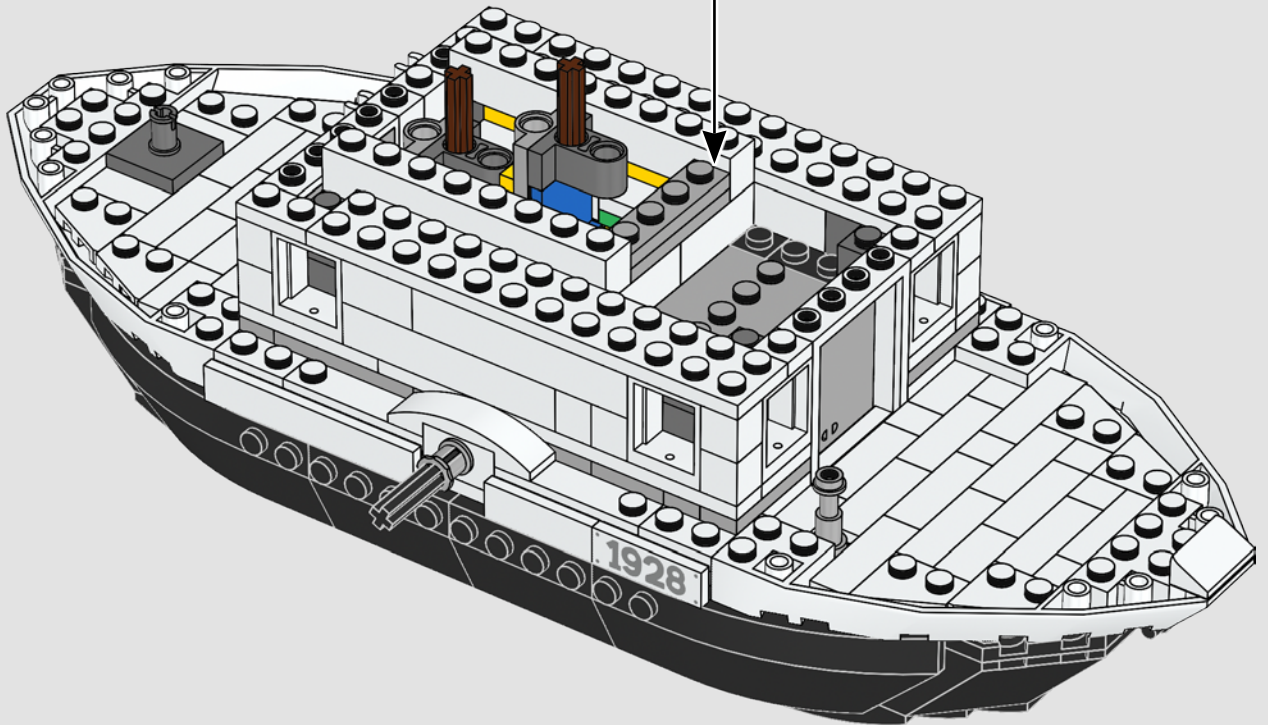
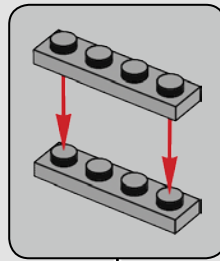



5x

123

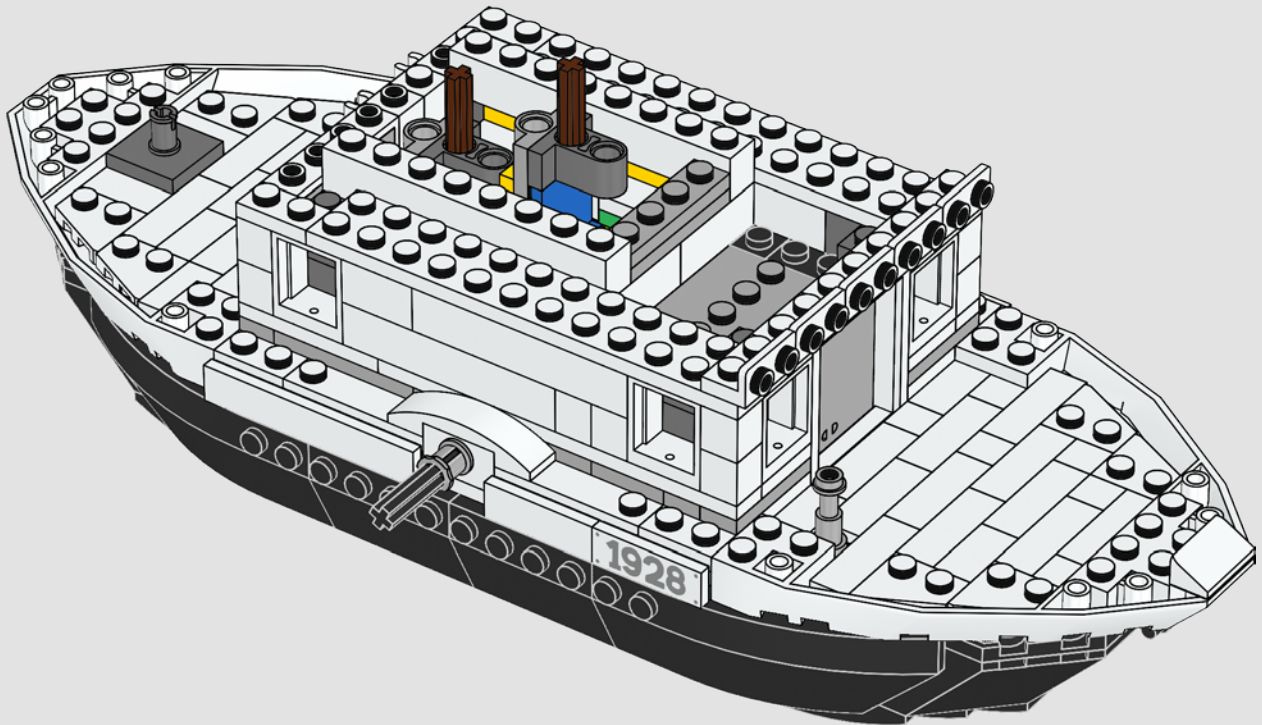

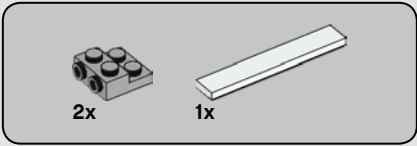

125

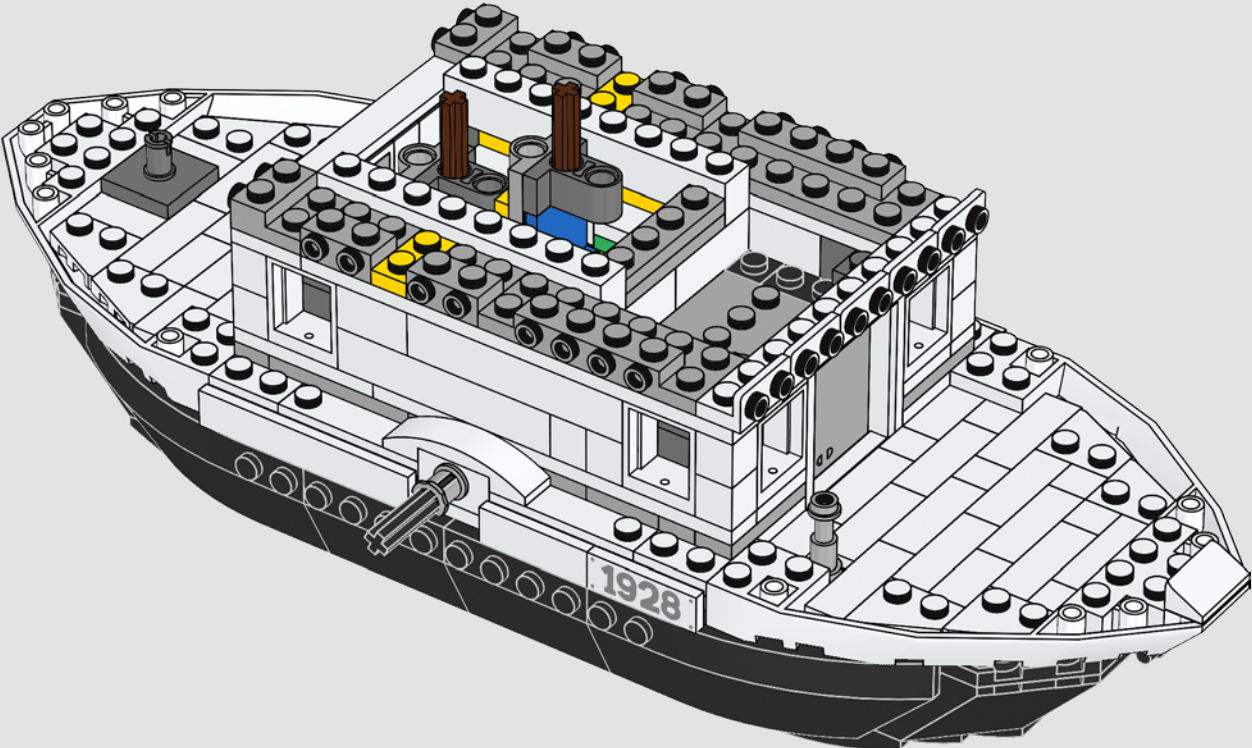

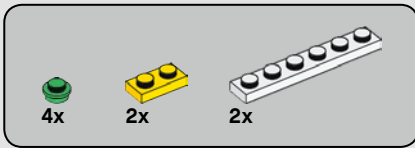

126

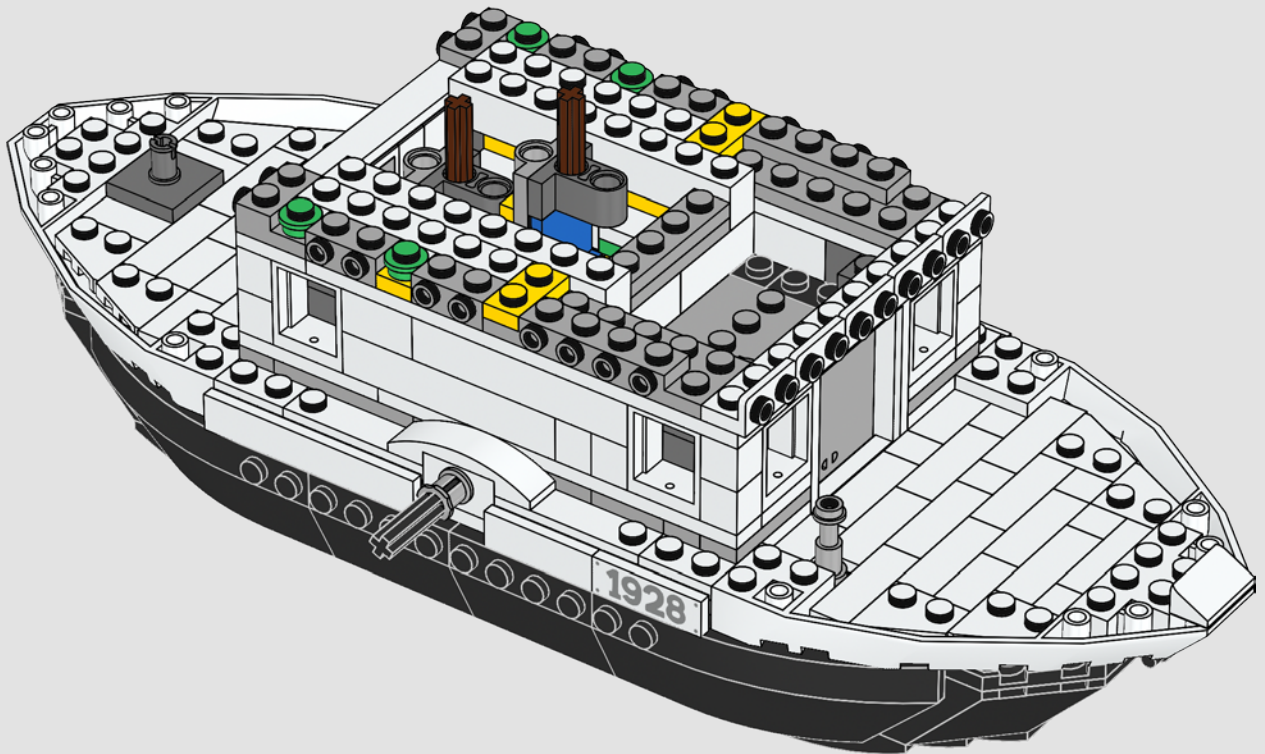

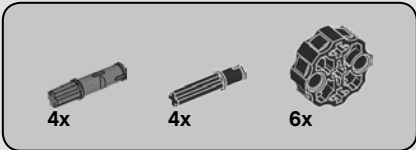

127

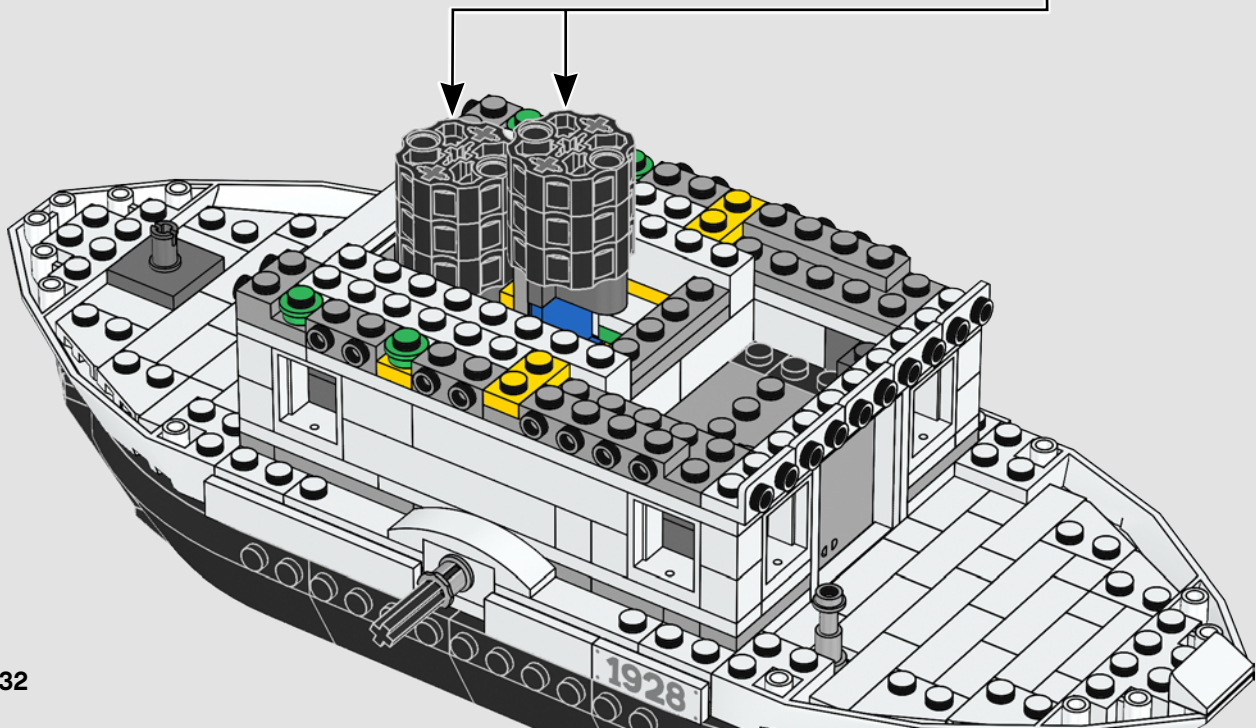
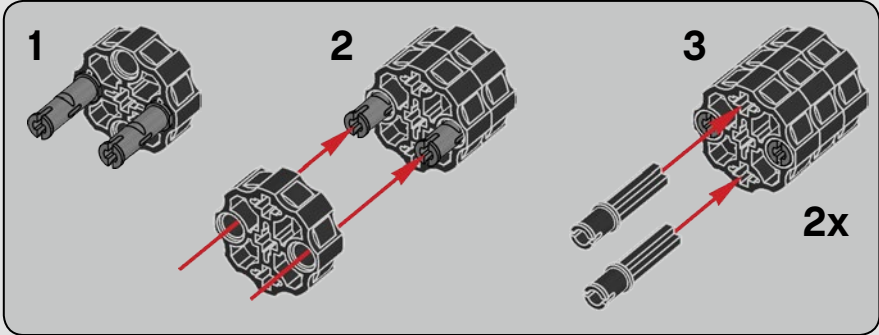



1x

128

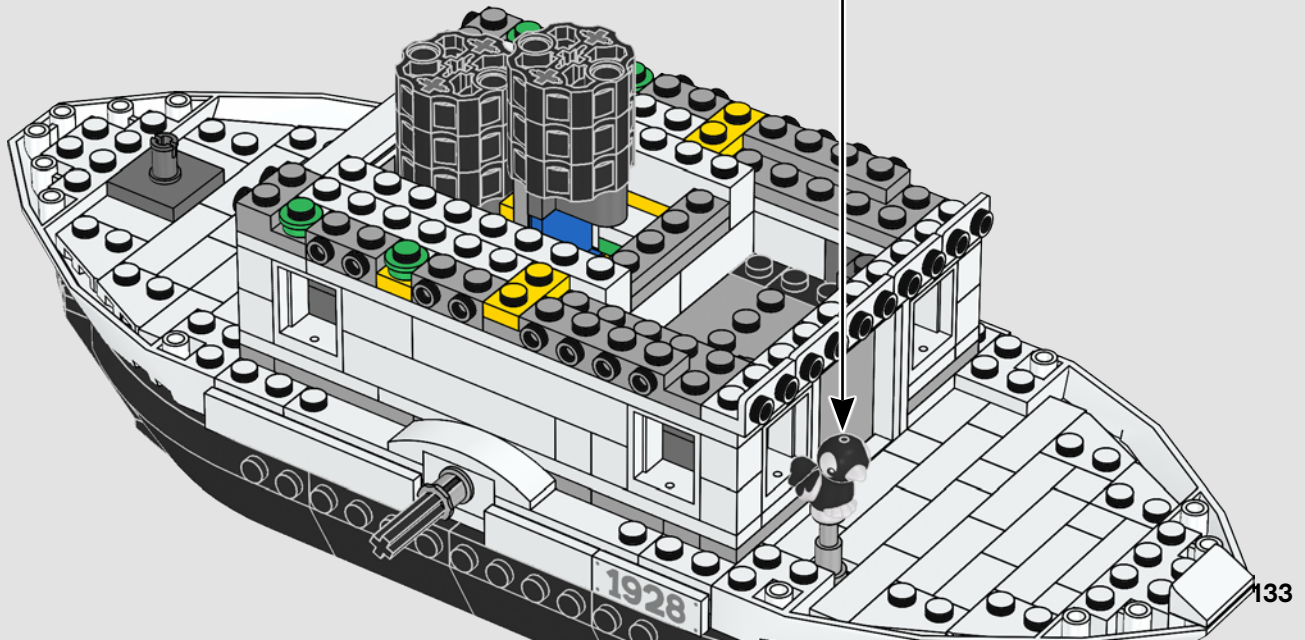

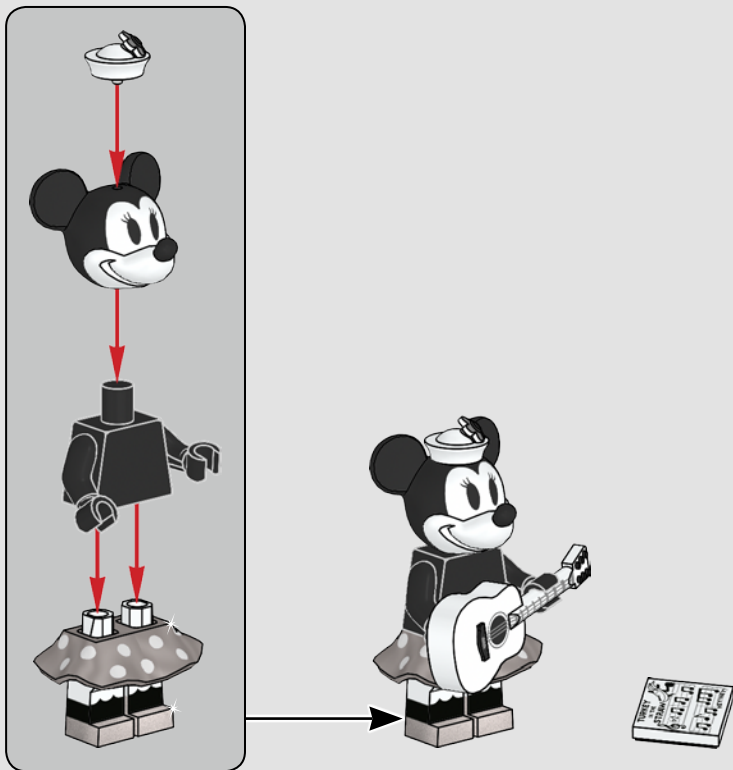
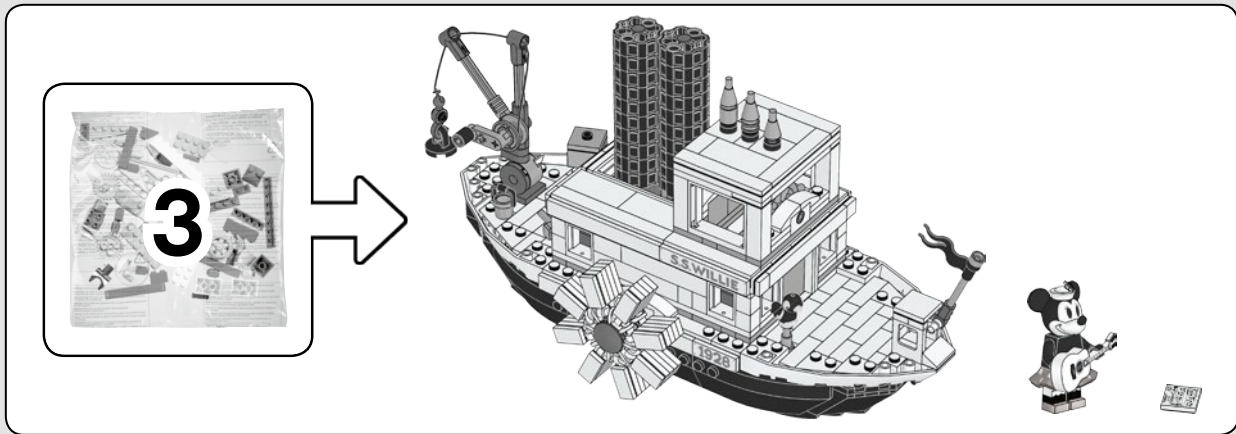

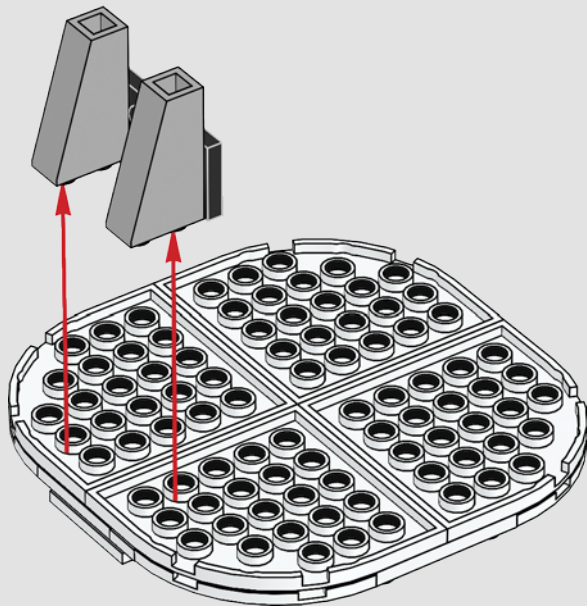



2x



2x



1x

129

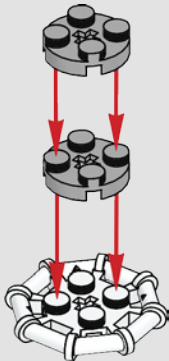

1x



1x

130

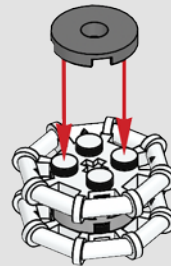



131

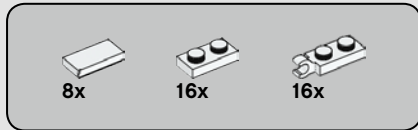
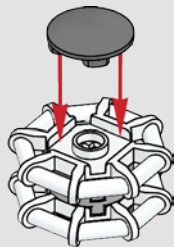

132

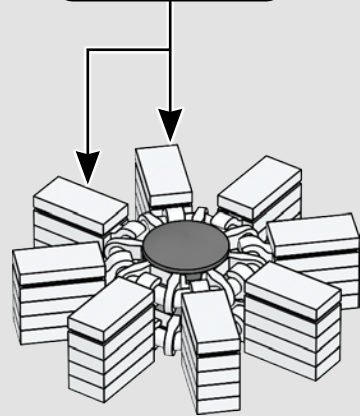
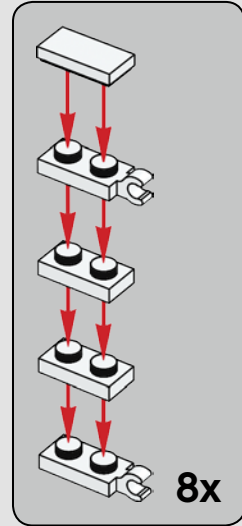

2x

133

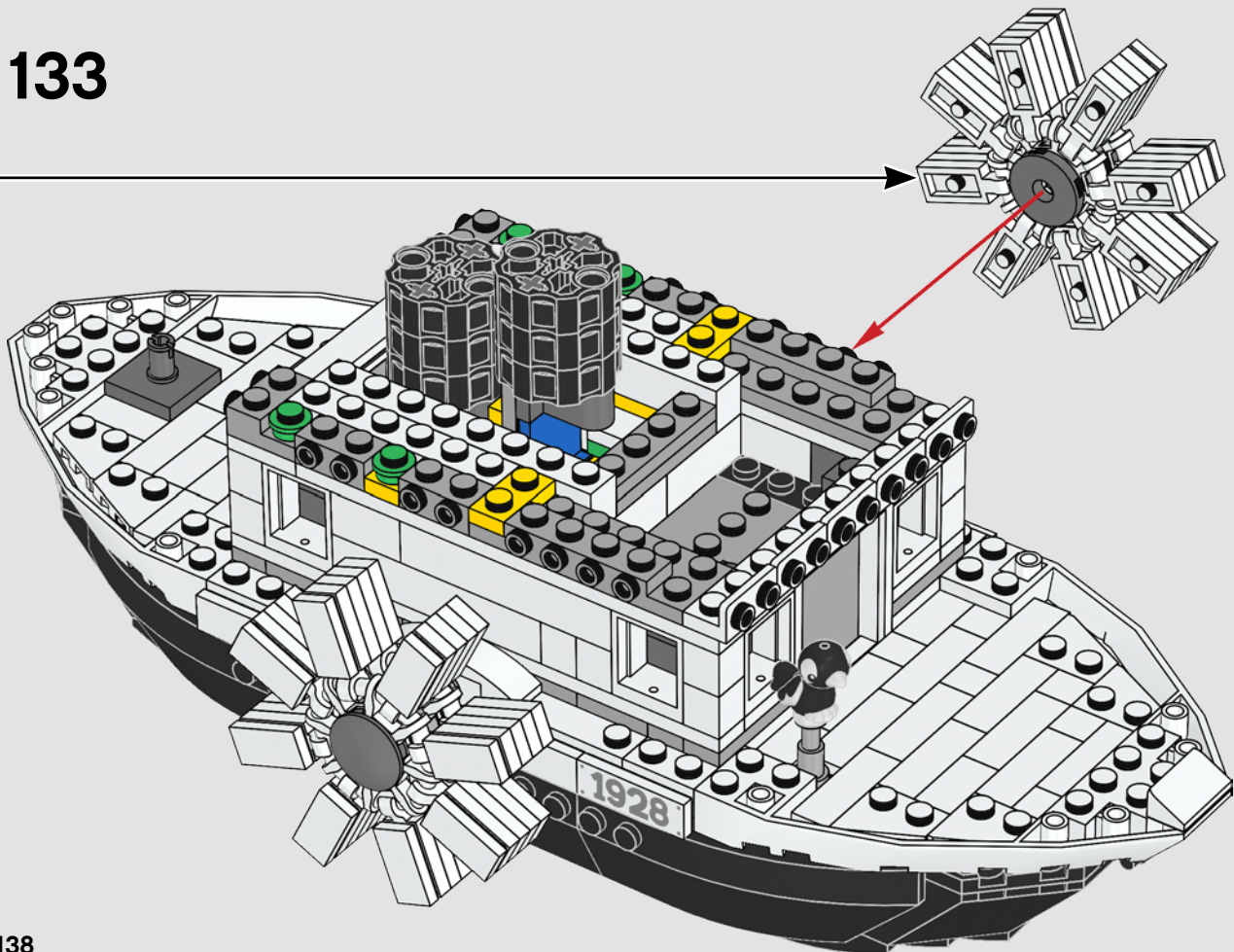

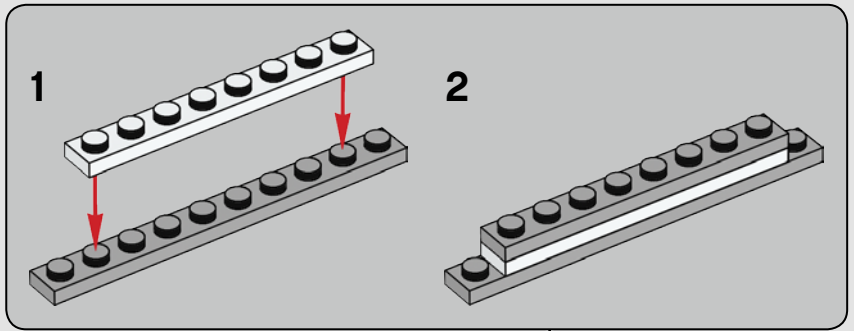
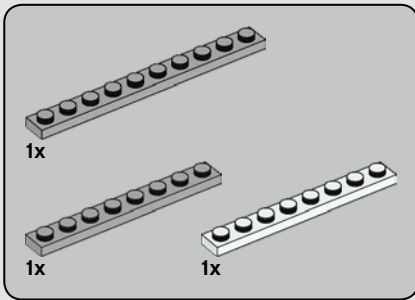

134

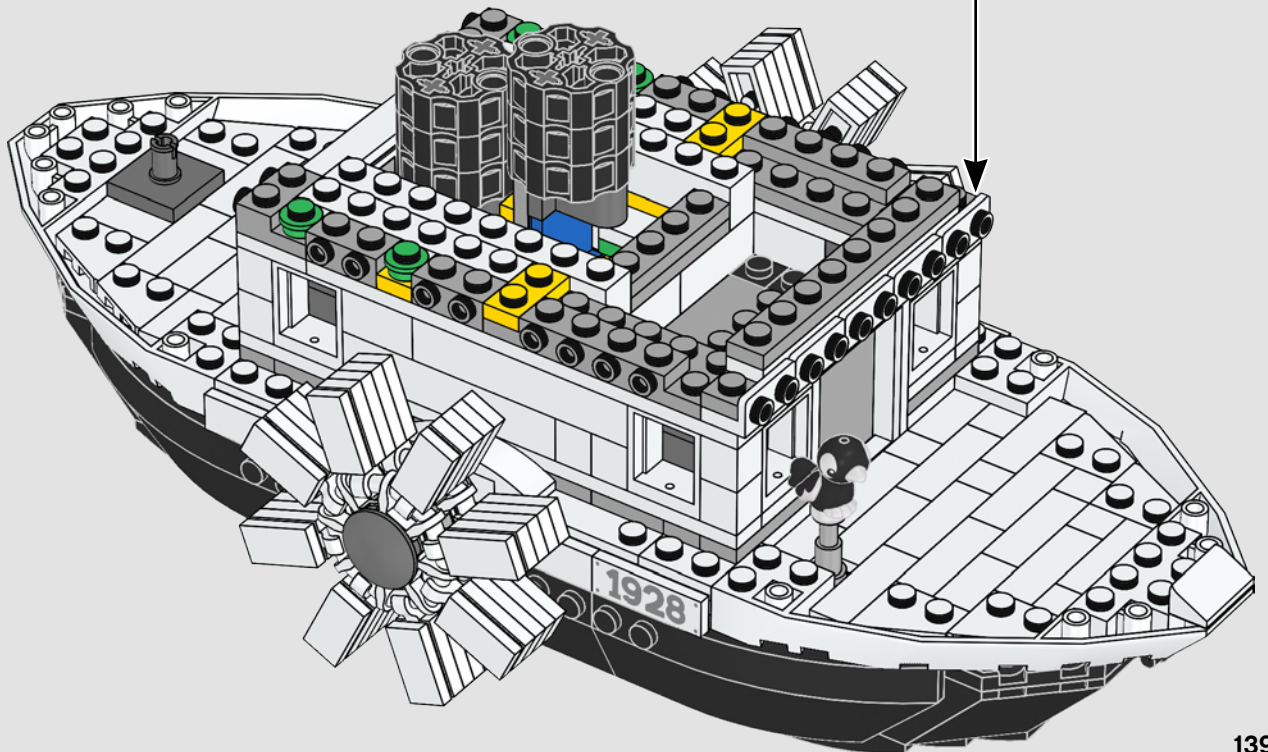



135

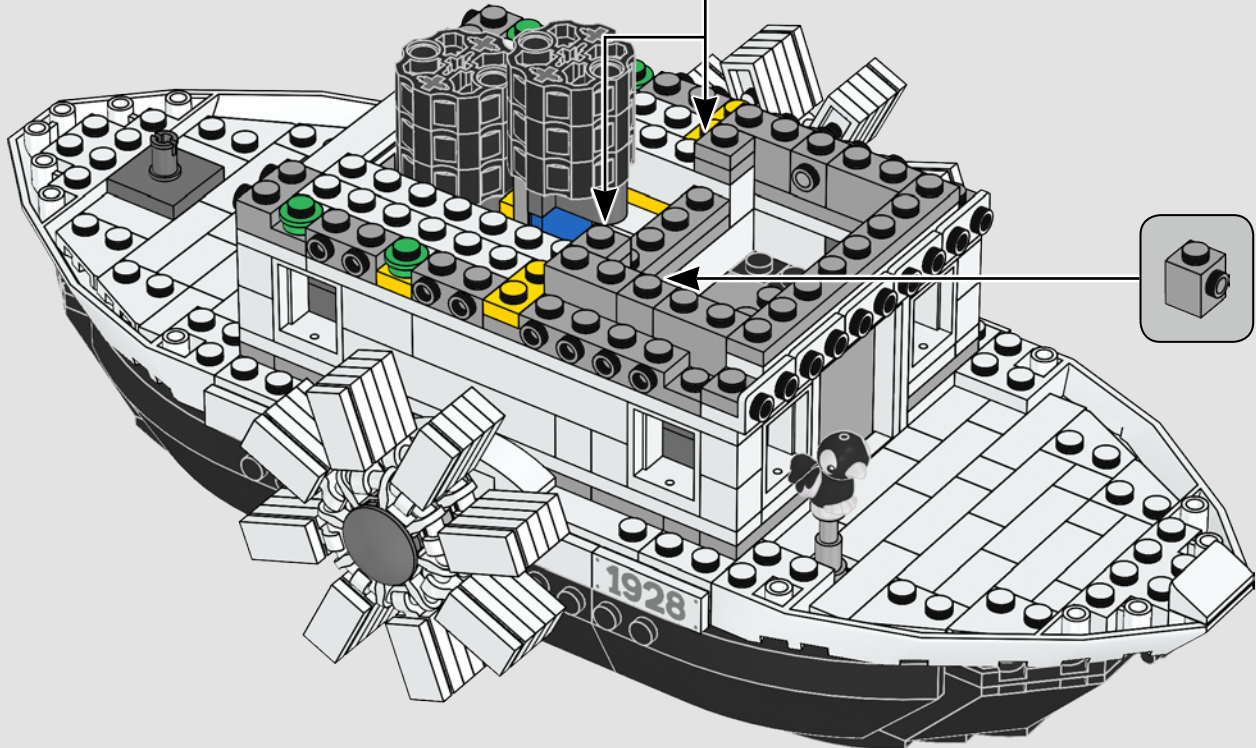
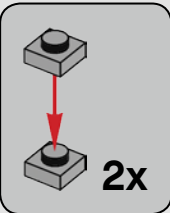



136

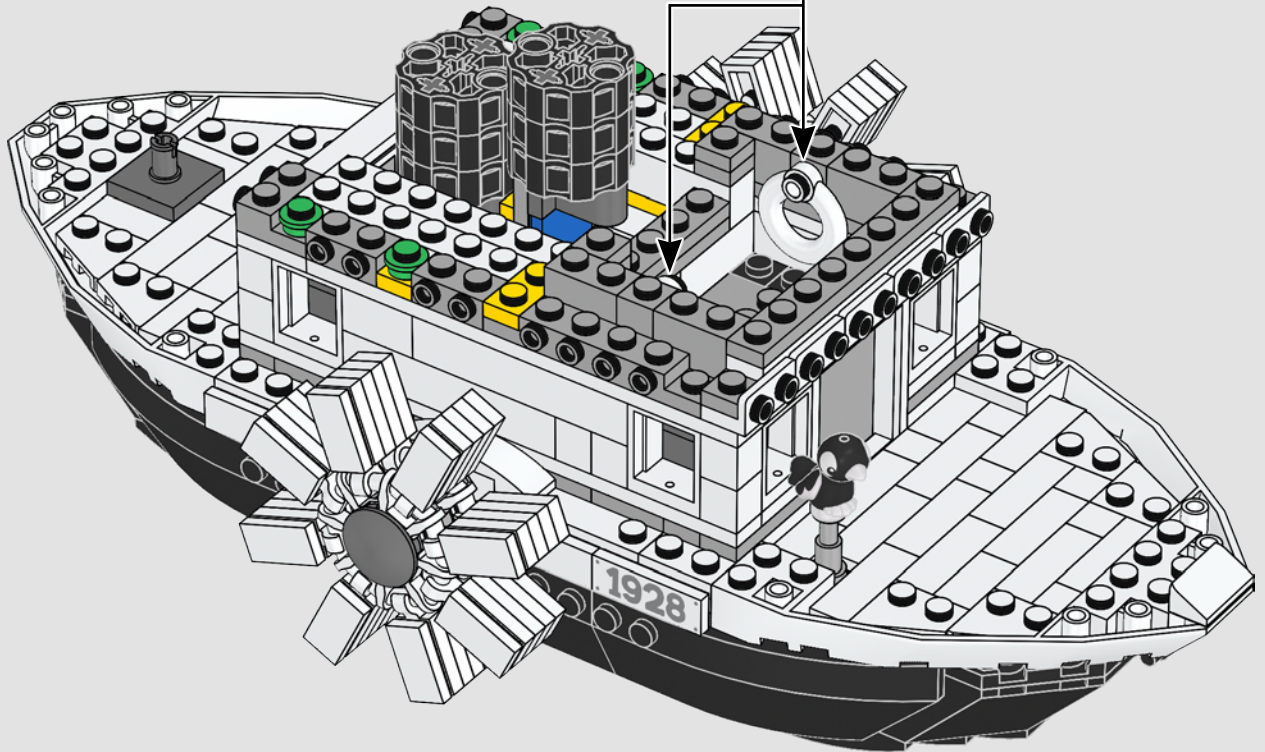

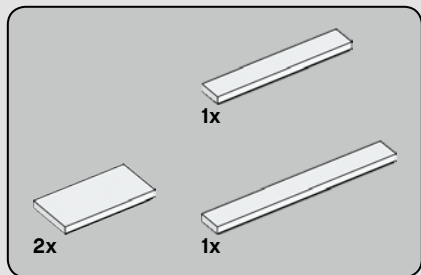

137

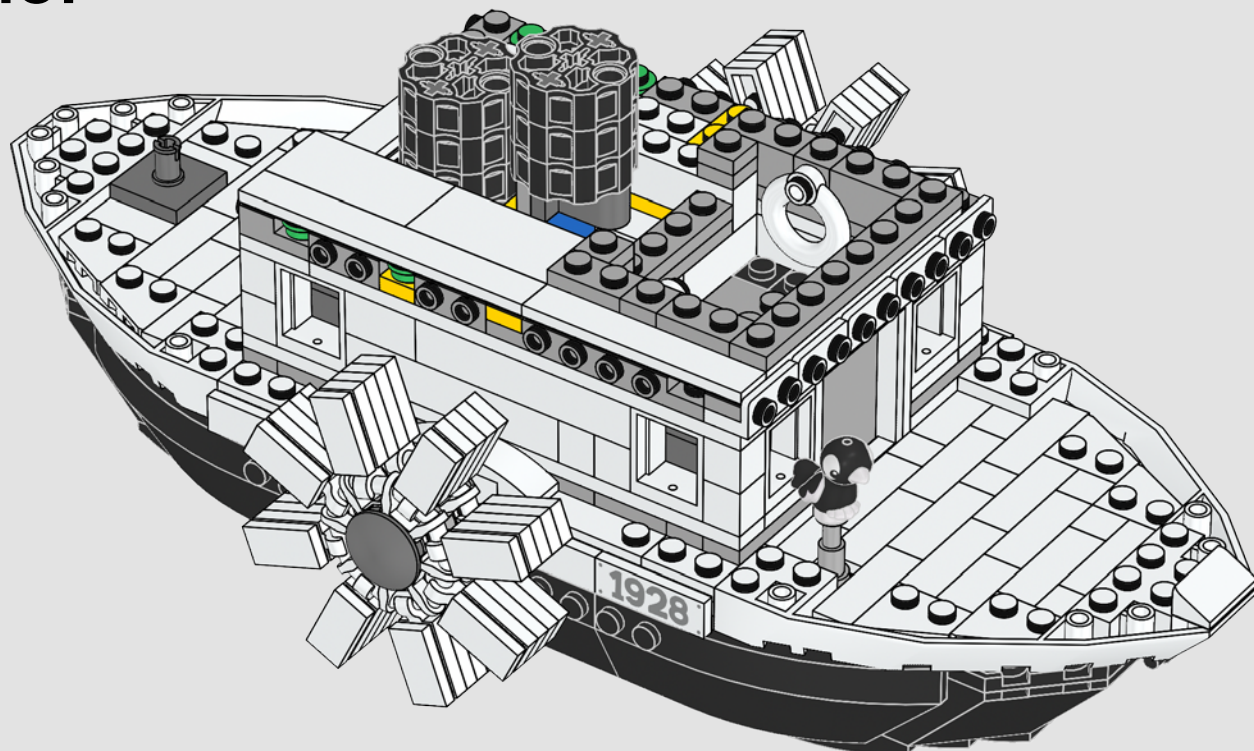

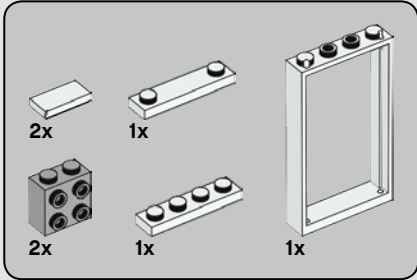
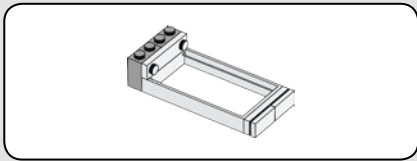

138

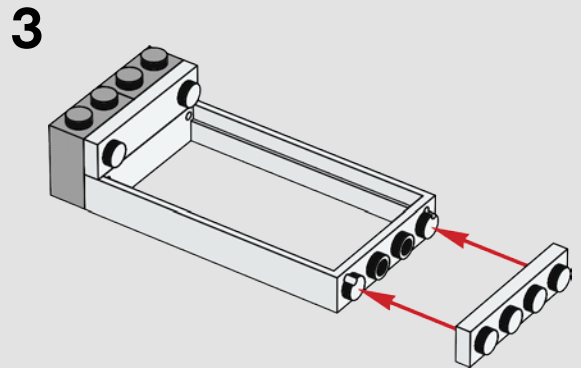
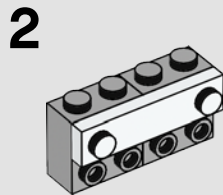
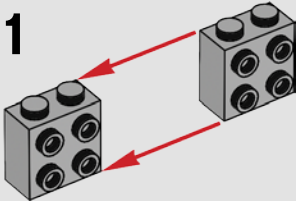

4

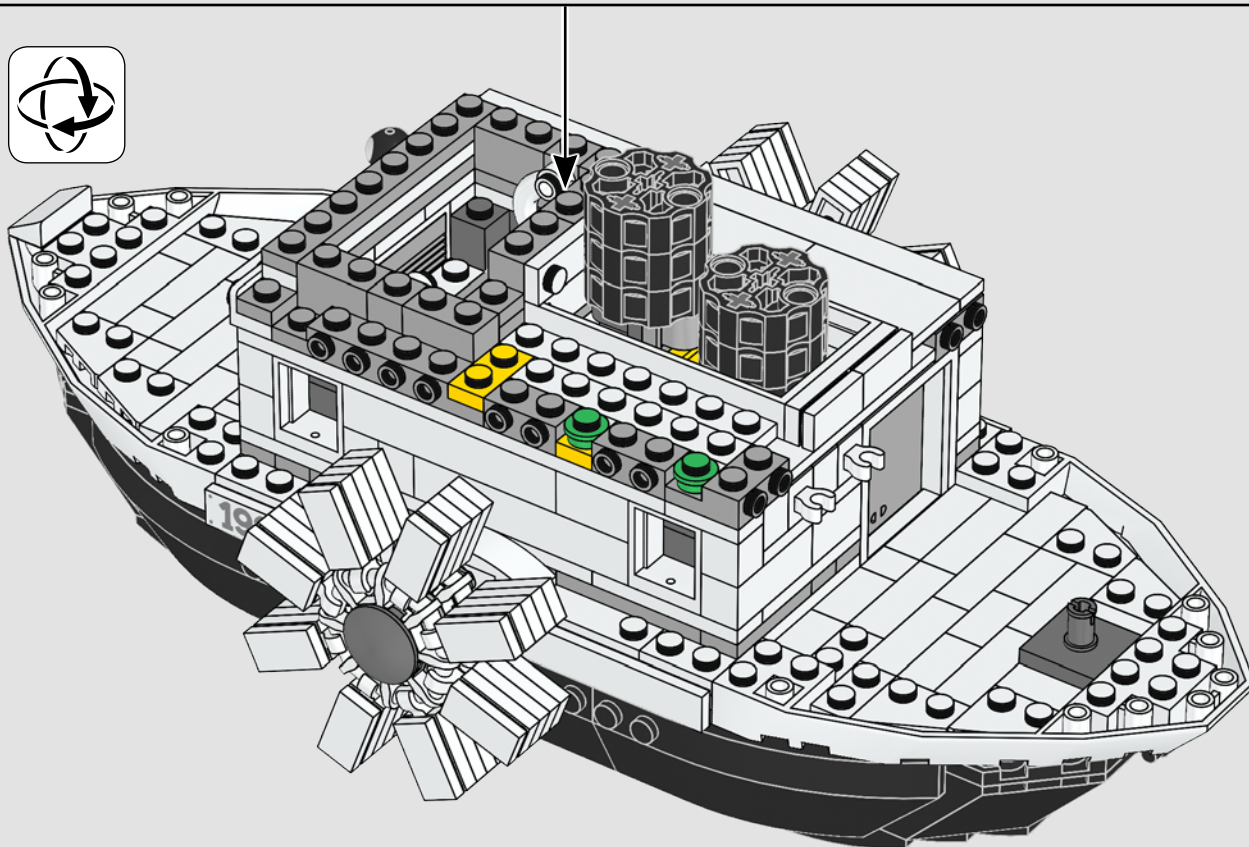
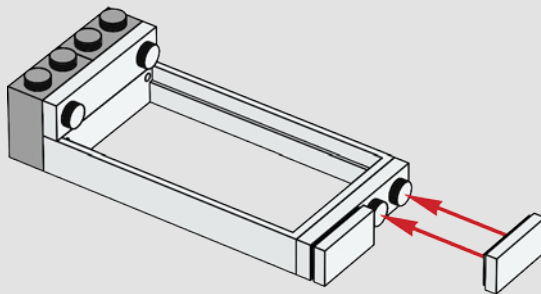

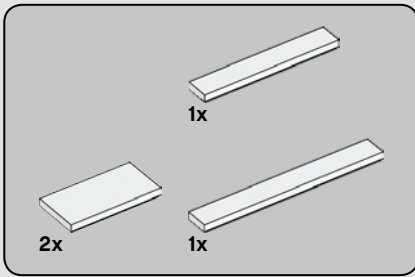

139

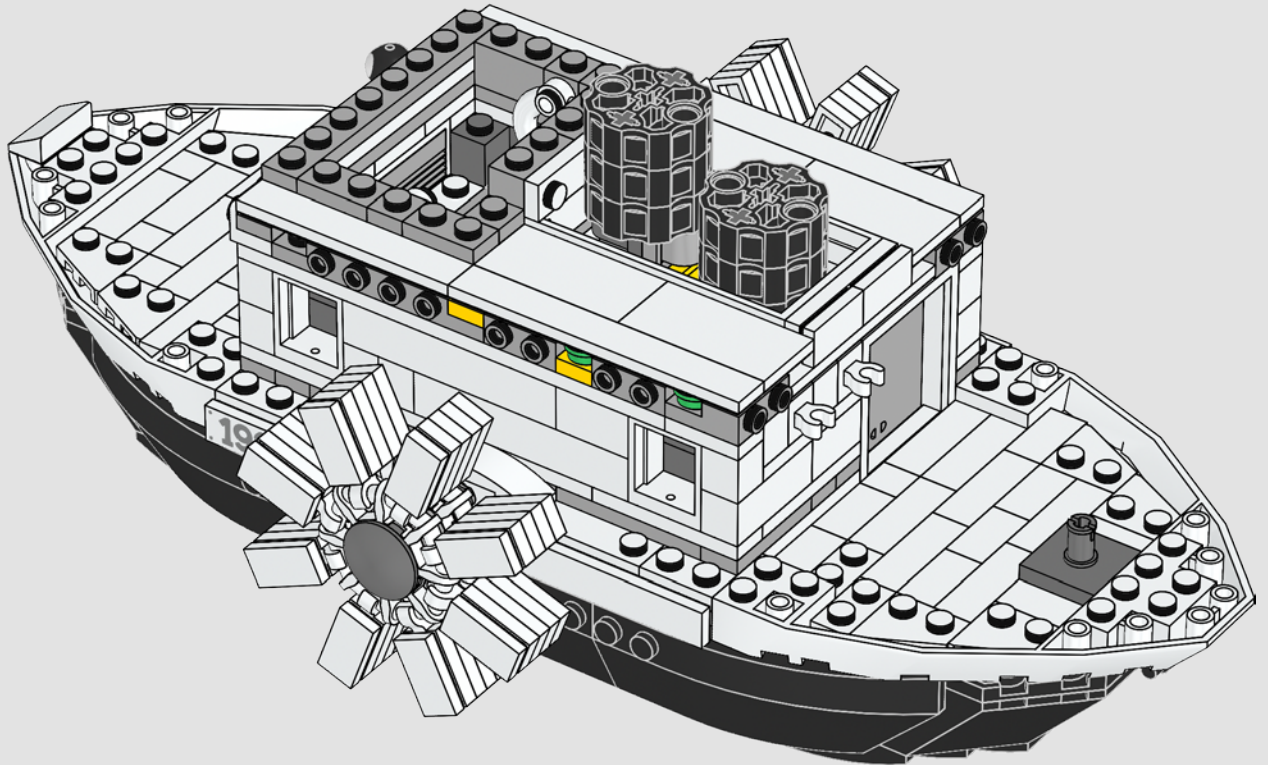

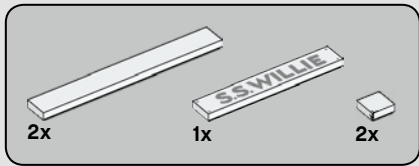

140

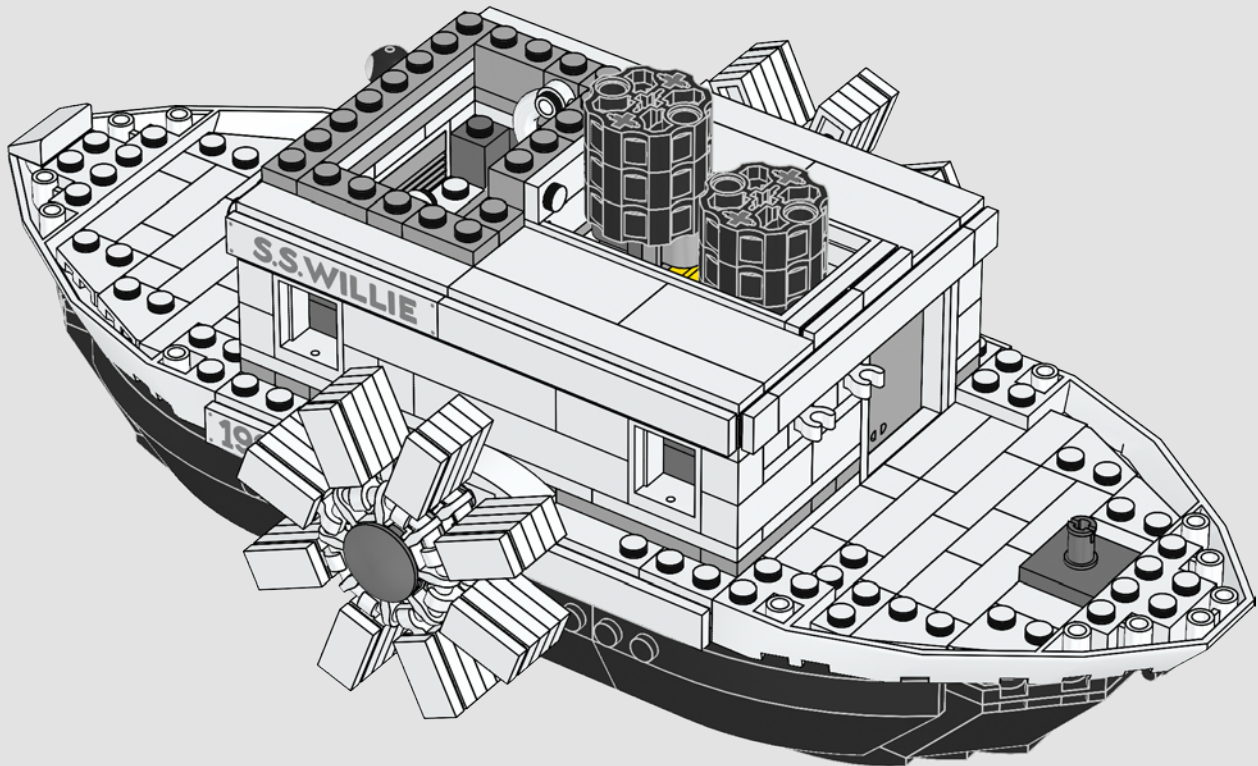

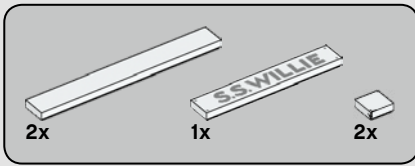

141

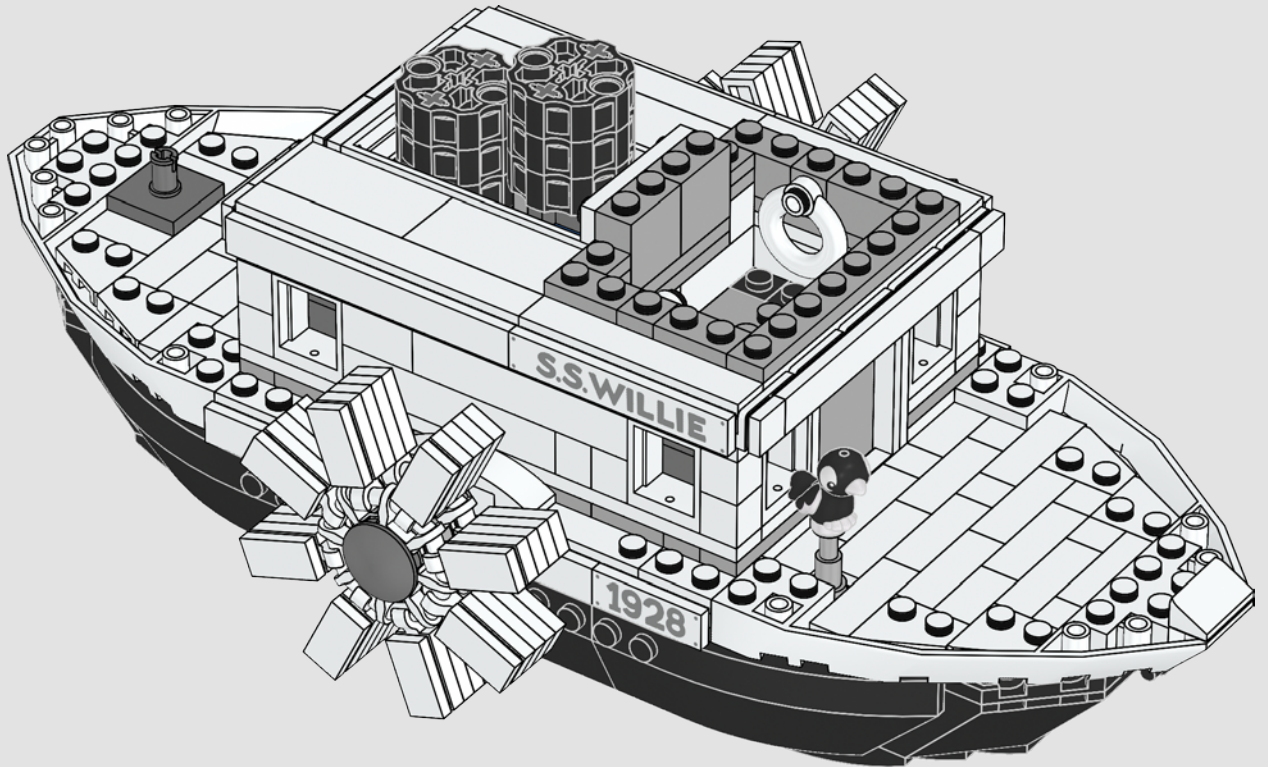



2x



4x

142

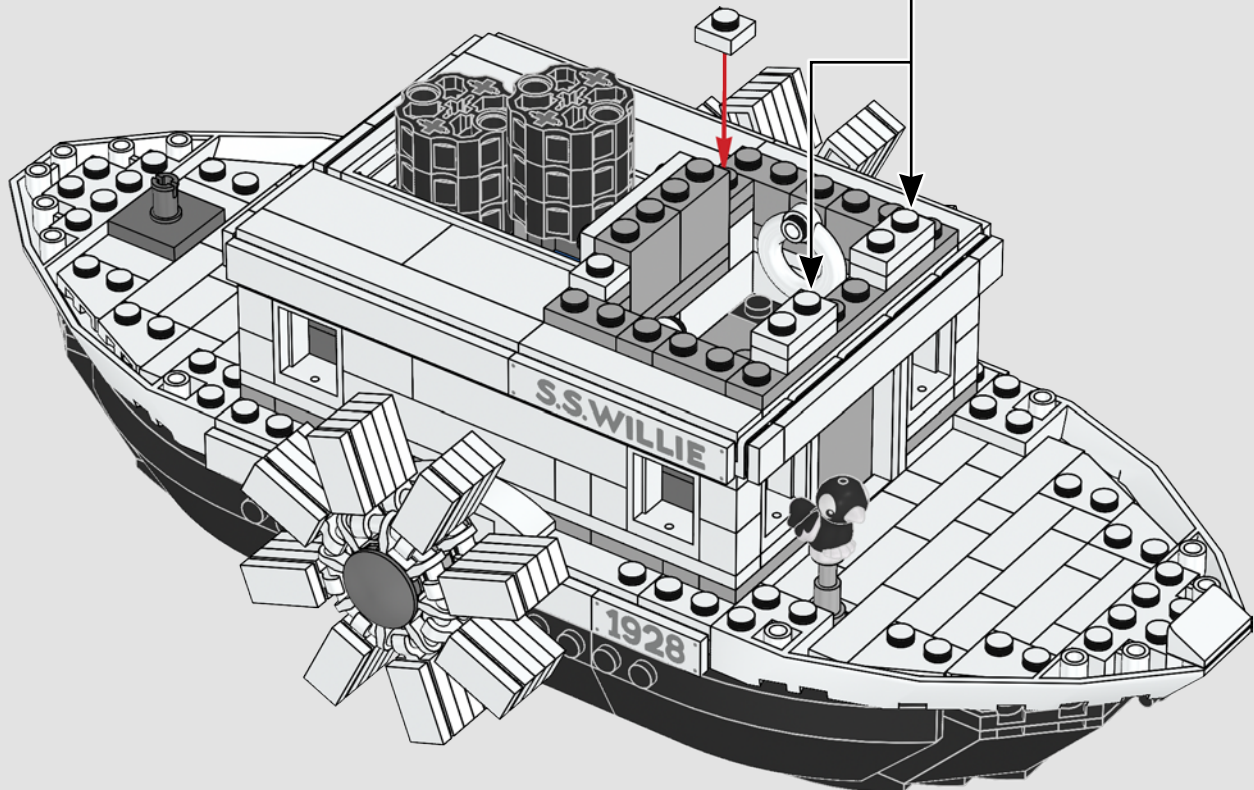
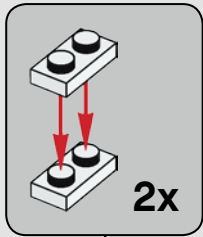

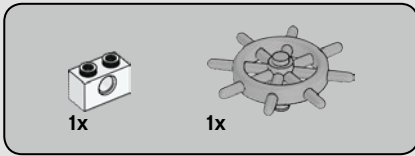

143

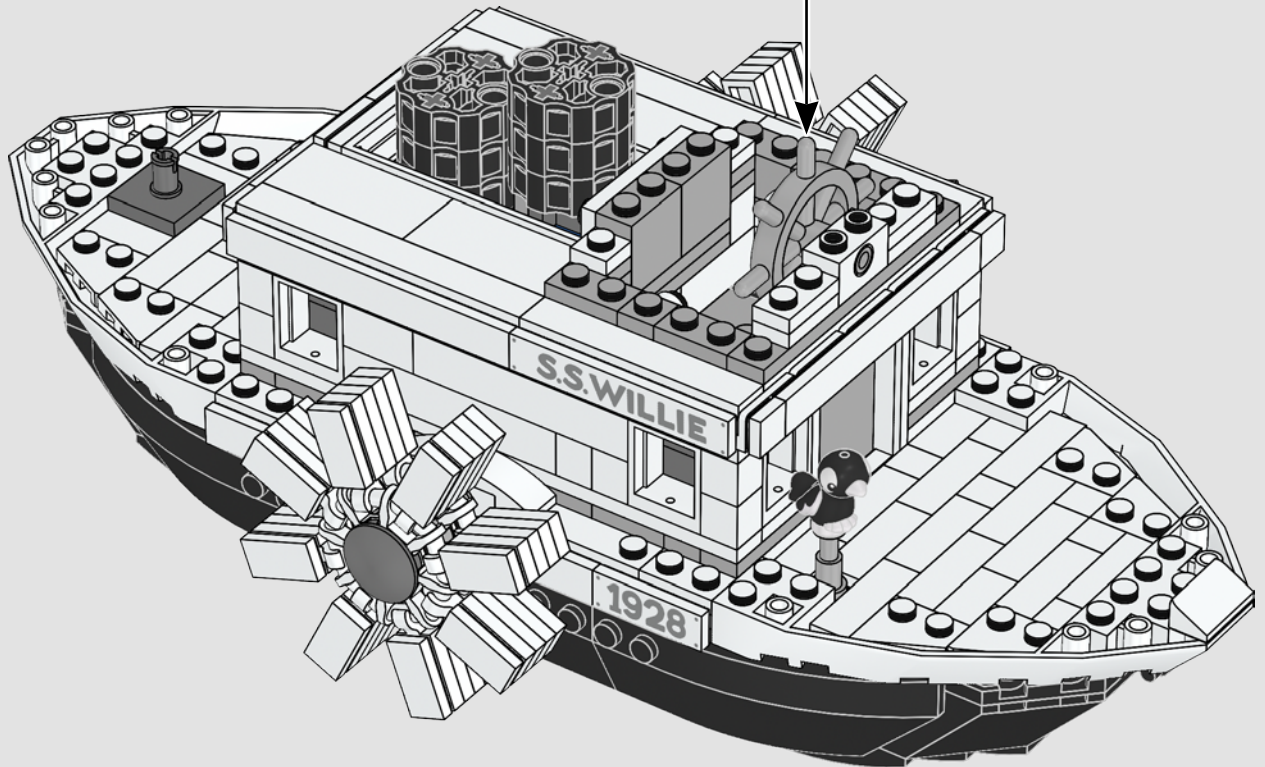
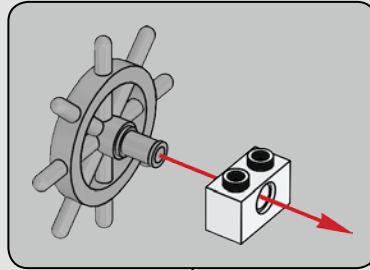



4x



1x

144

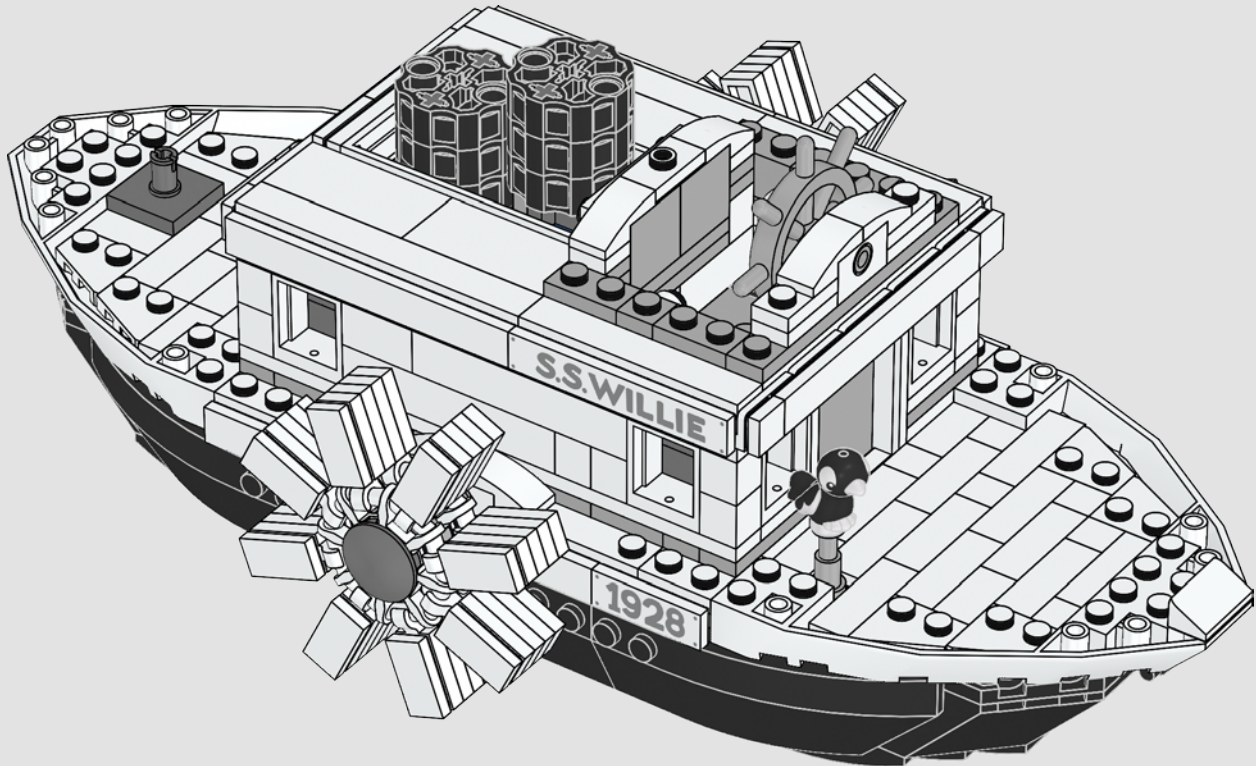



145

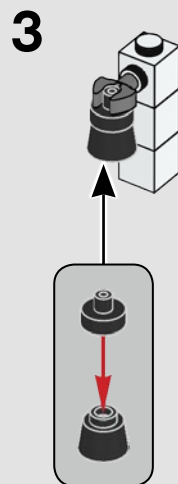
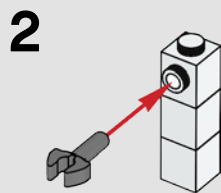
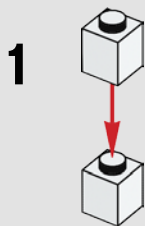

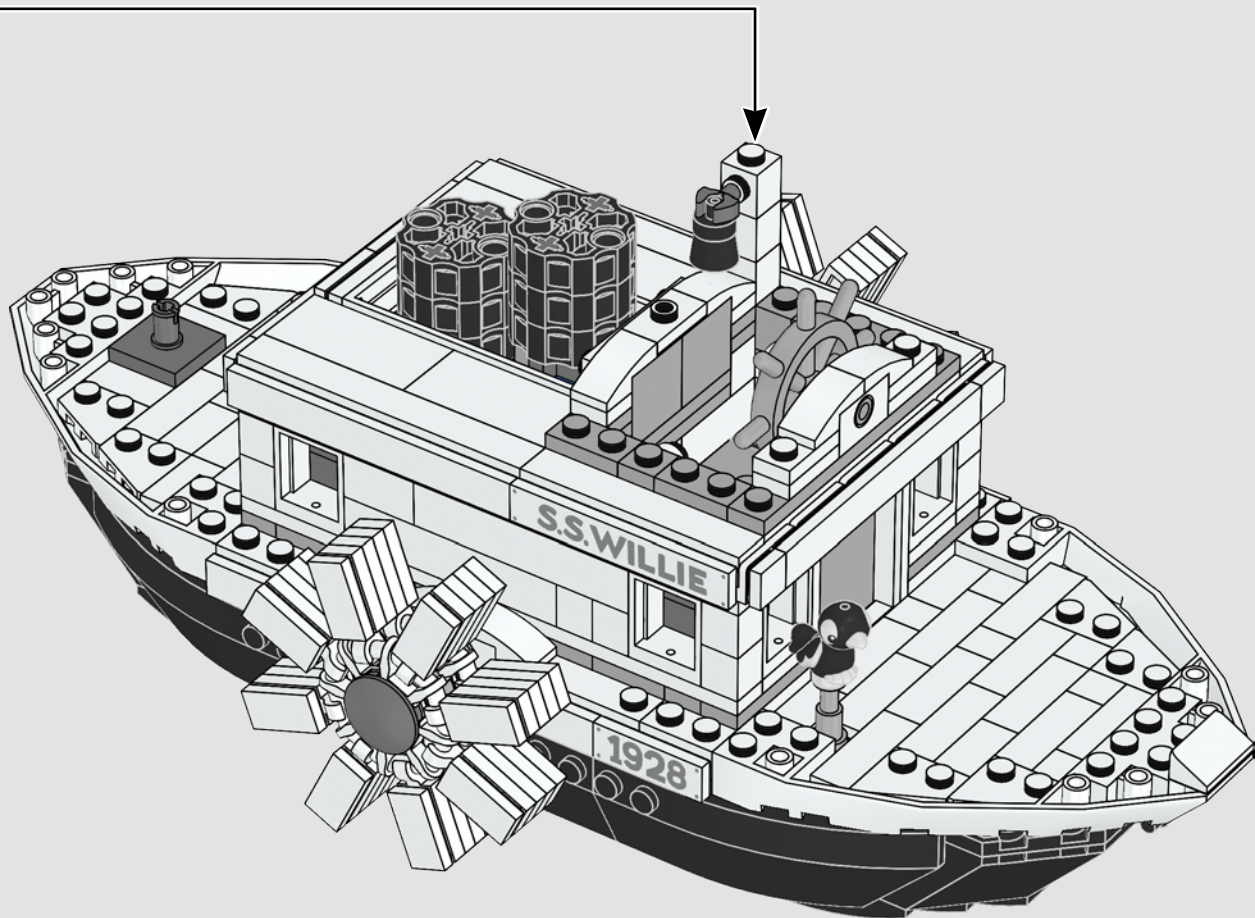

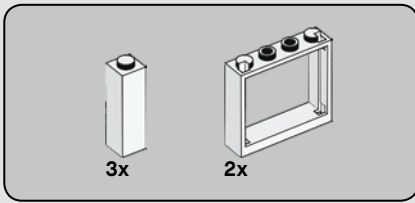

146

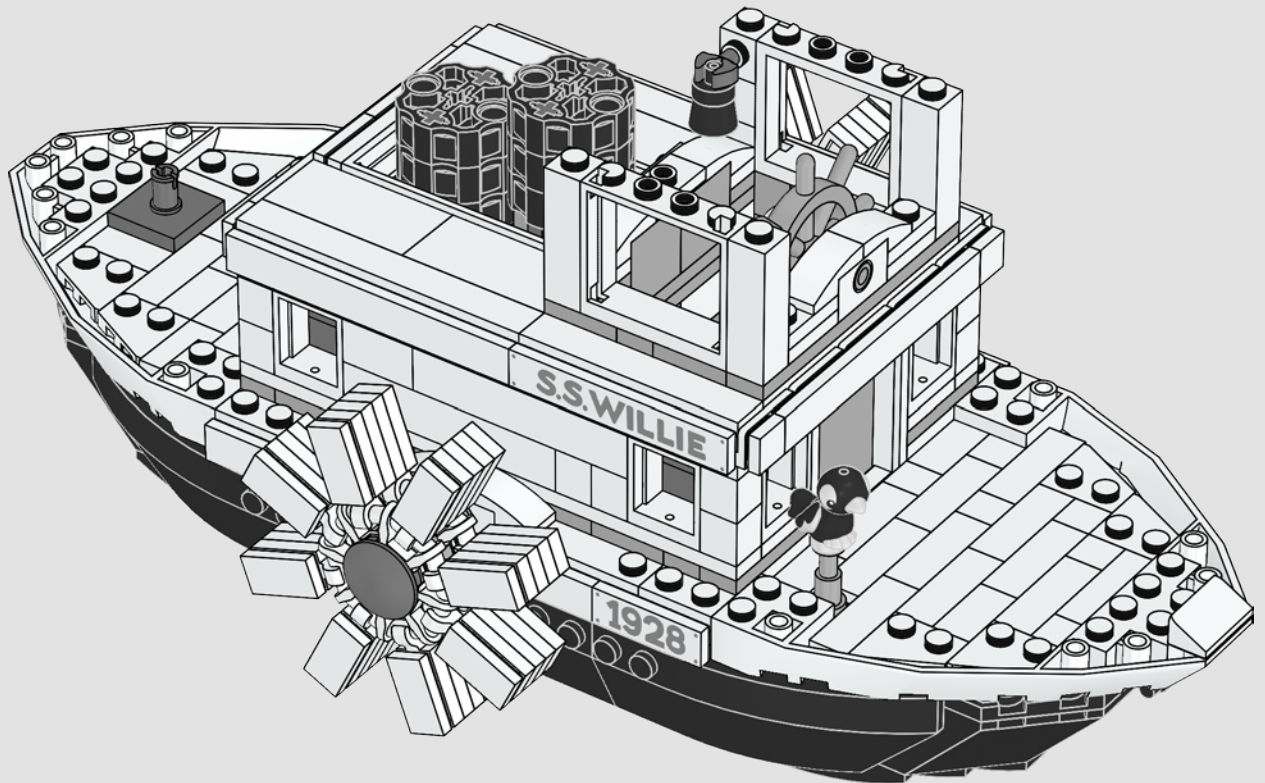

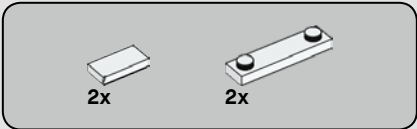

147

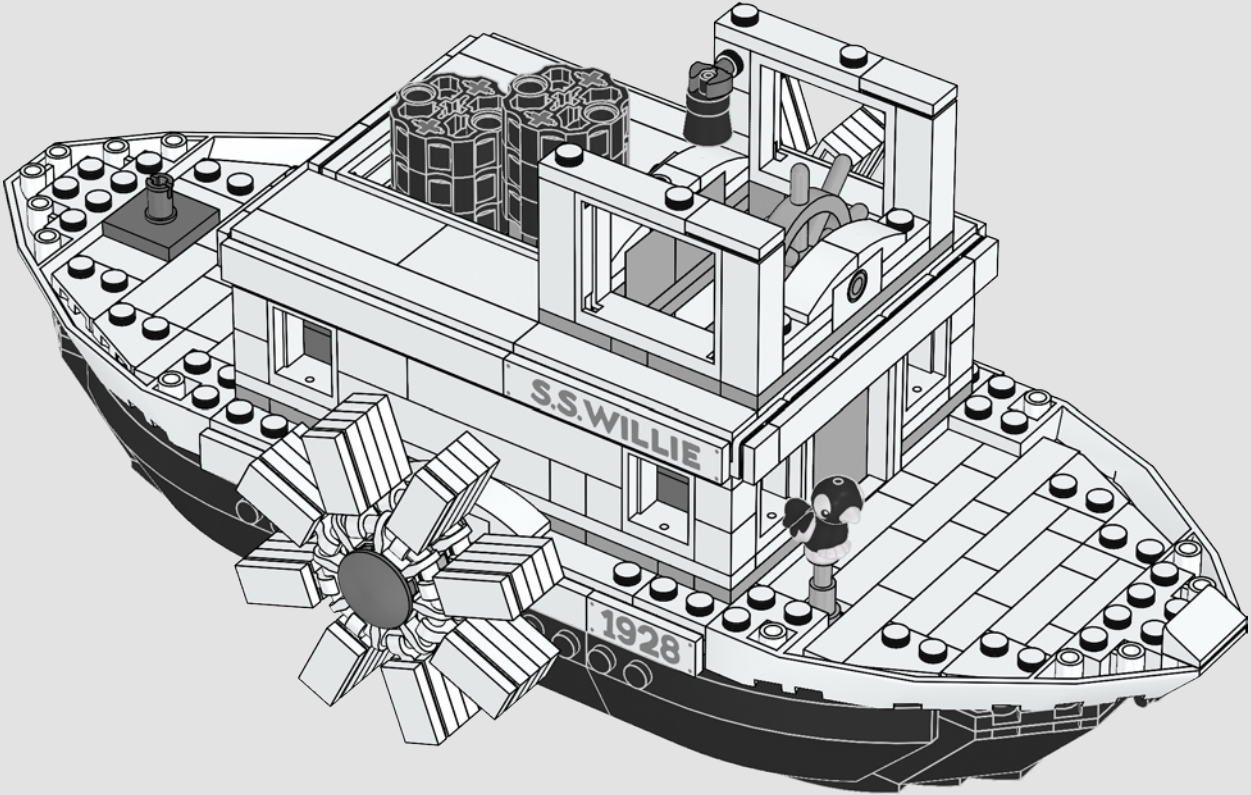

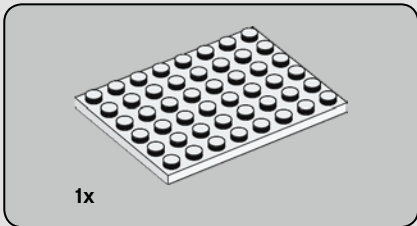
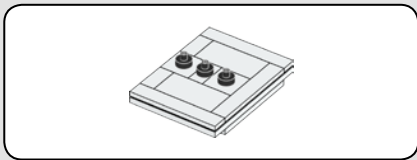

148

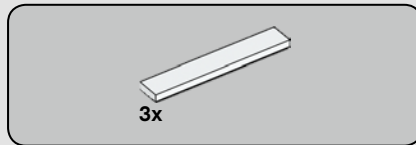
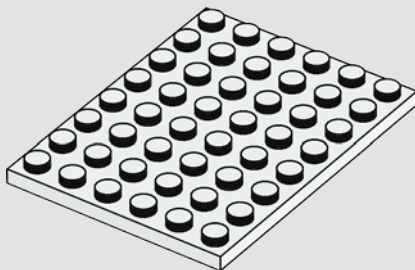

149

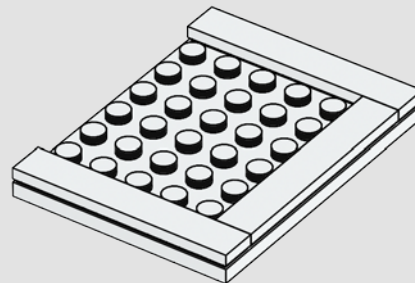

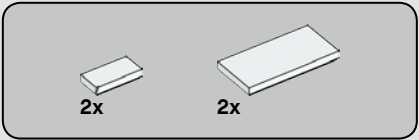

150

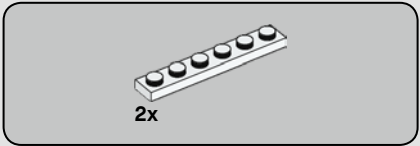
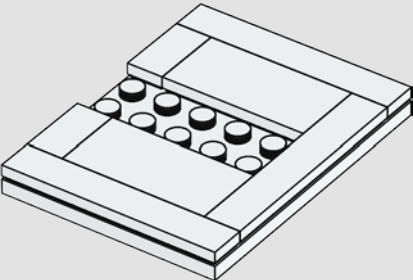

151

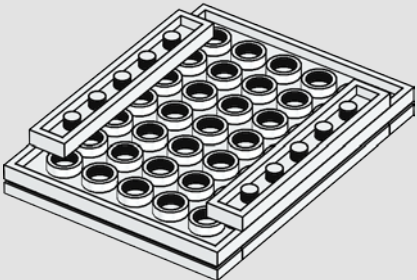

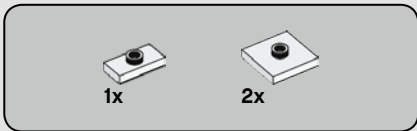

152

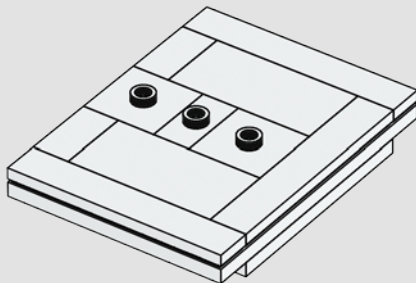

153

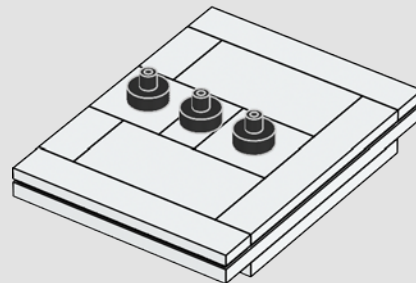

154

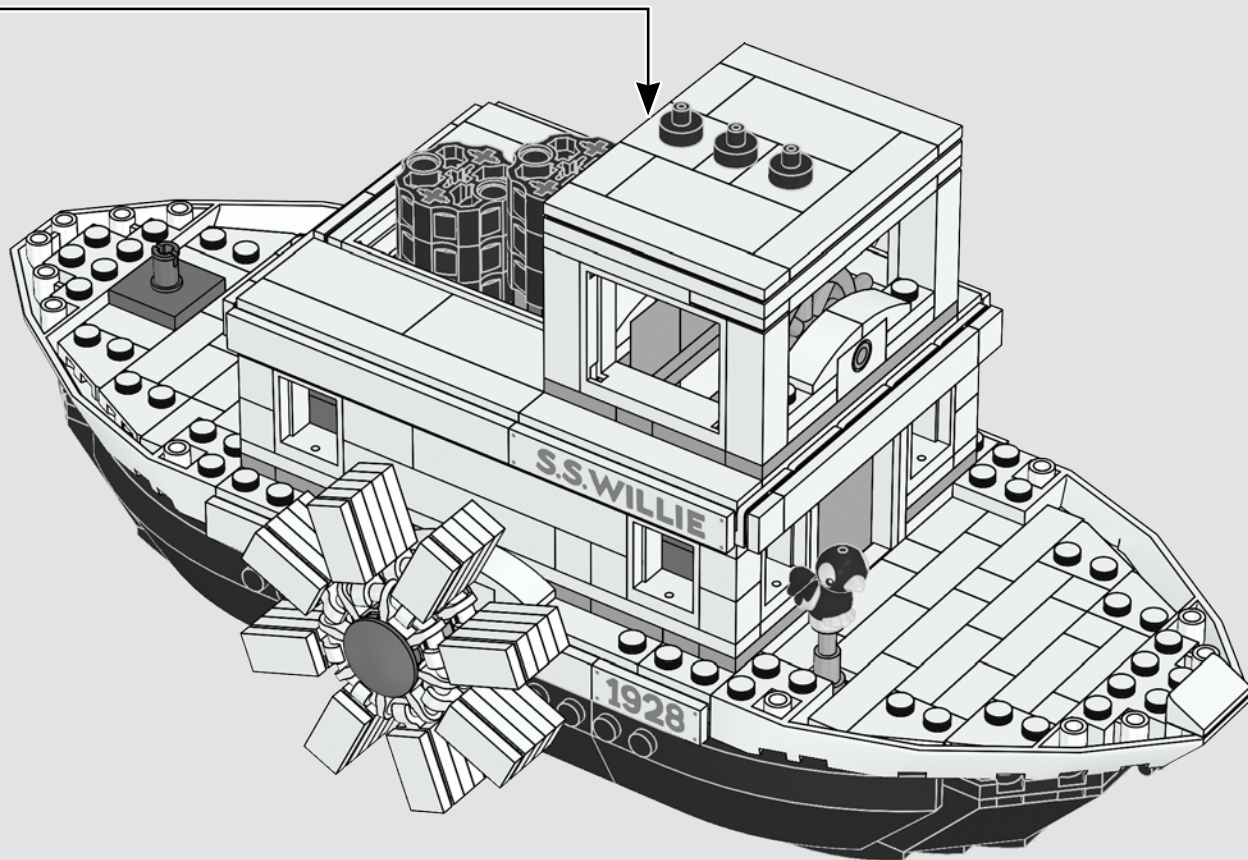

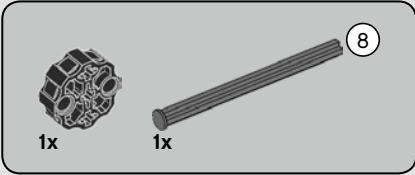
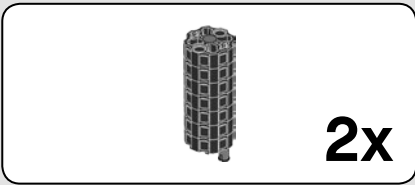

155

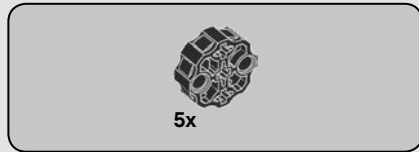
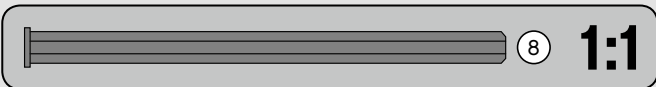
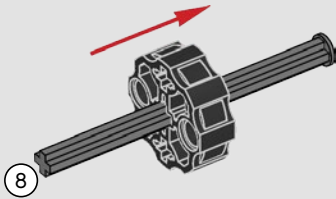

156

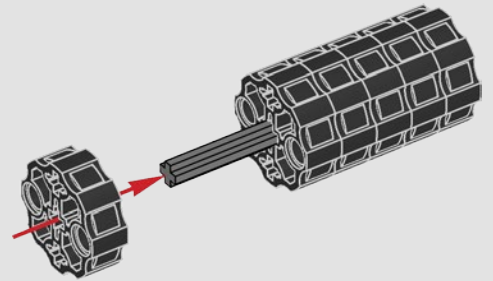

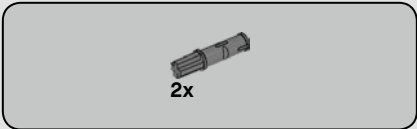

157

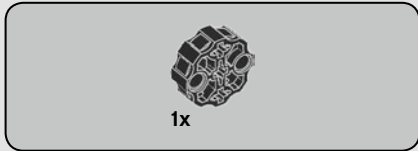
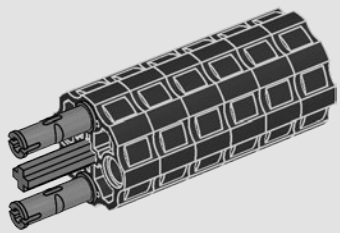

158

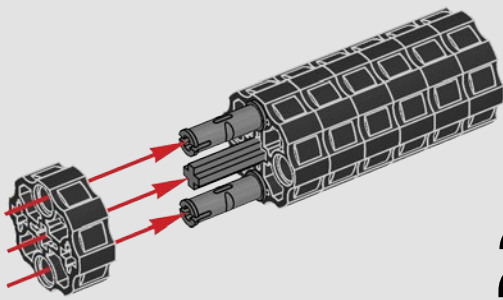

2x

159

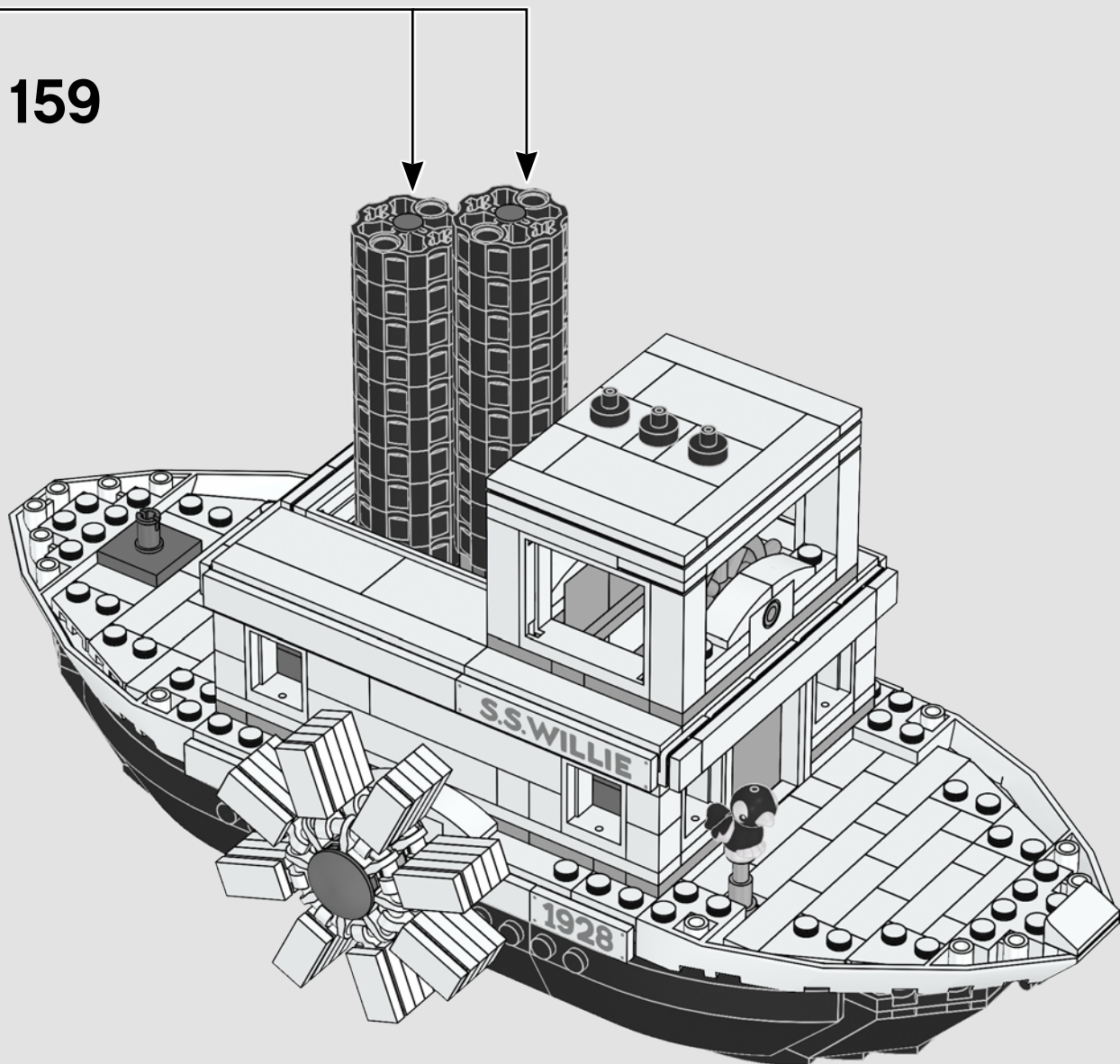

2x 1x 3x

160

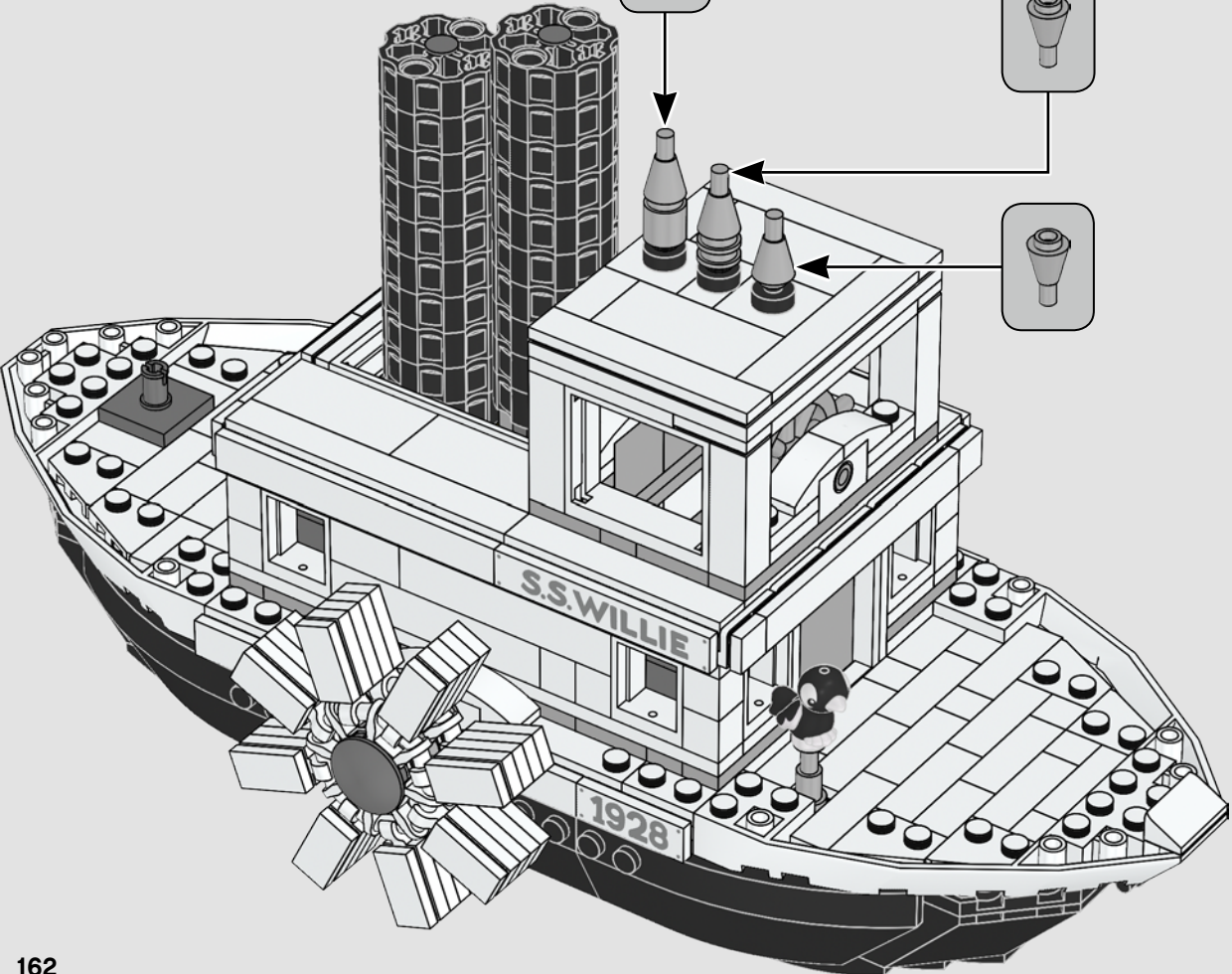
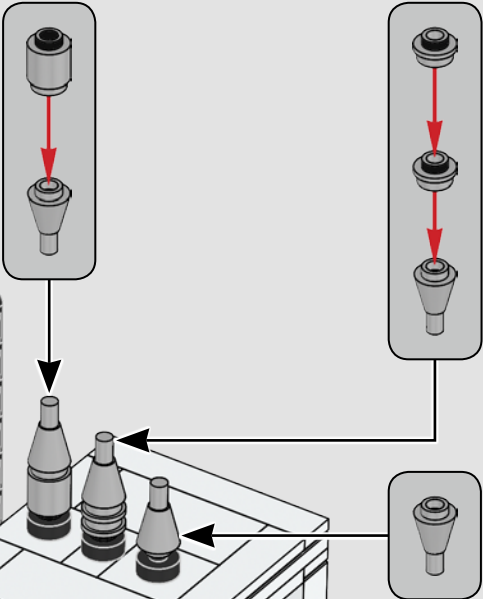

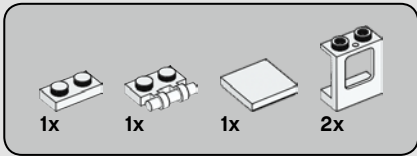

161

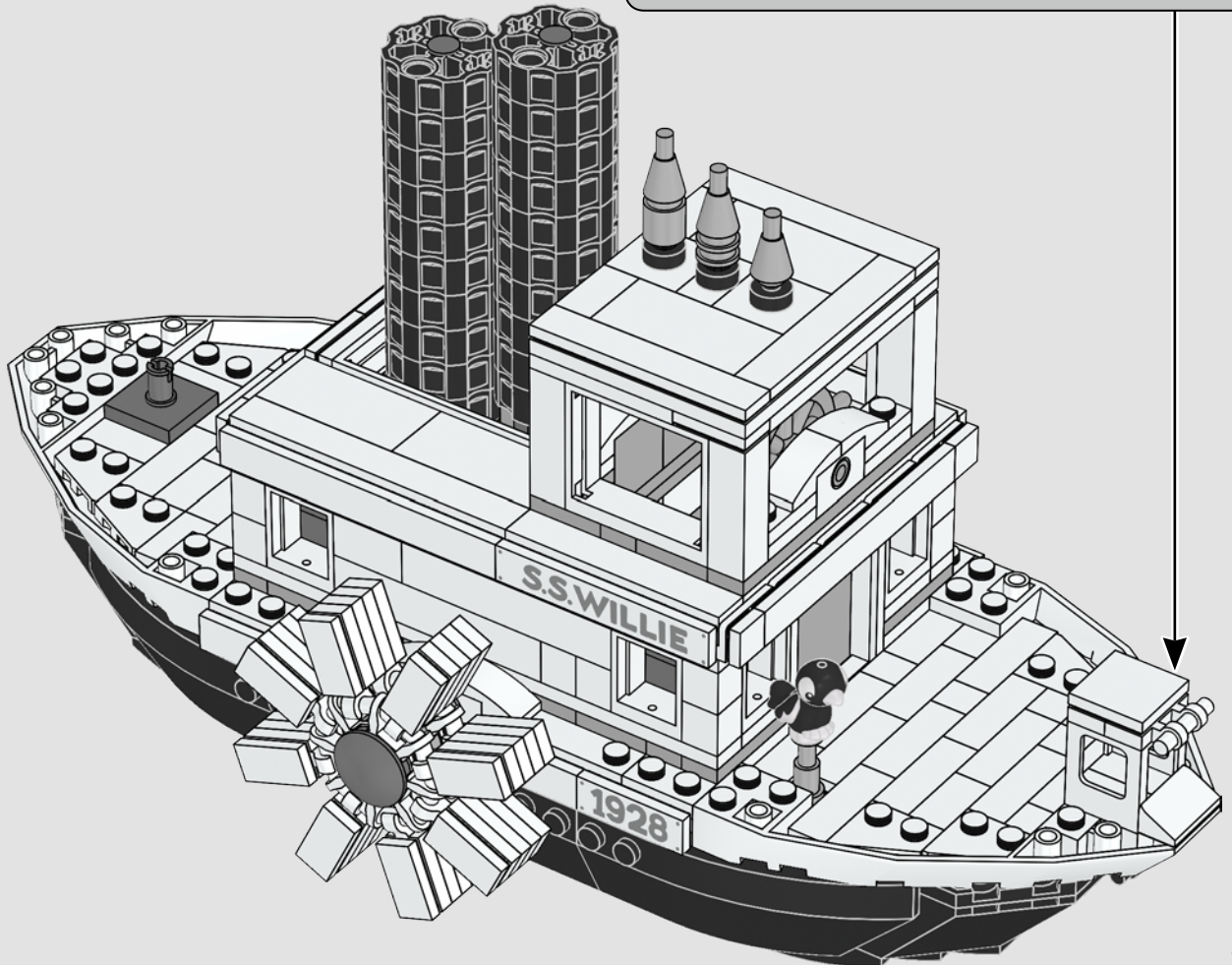
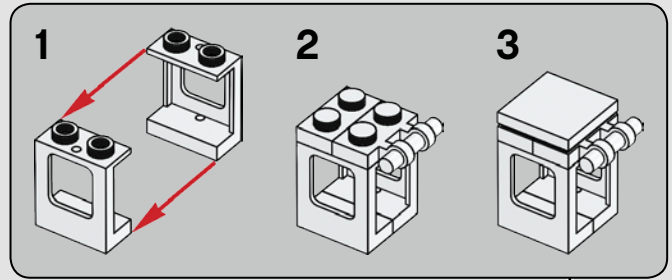

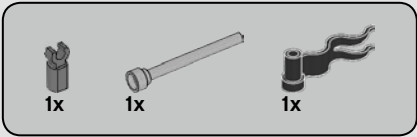

162

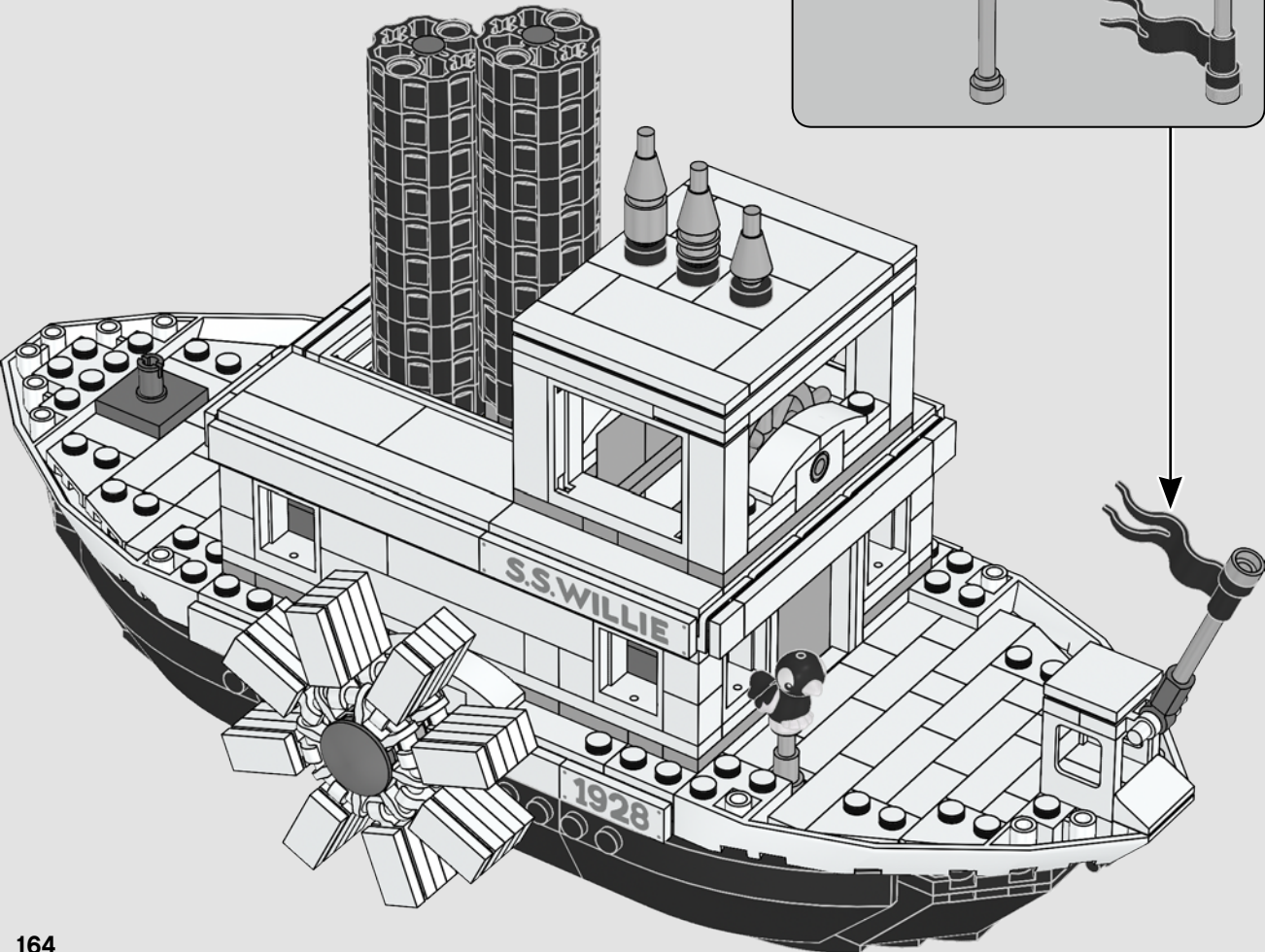
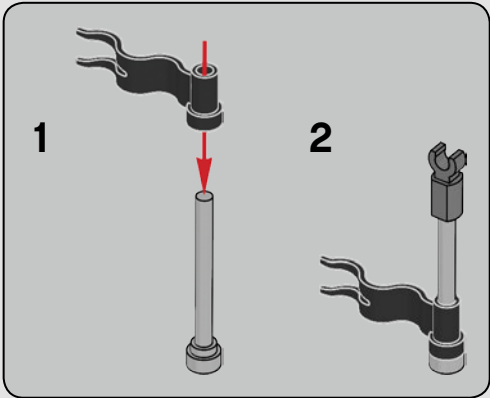

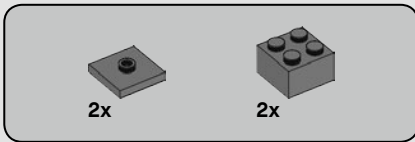

163

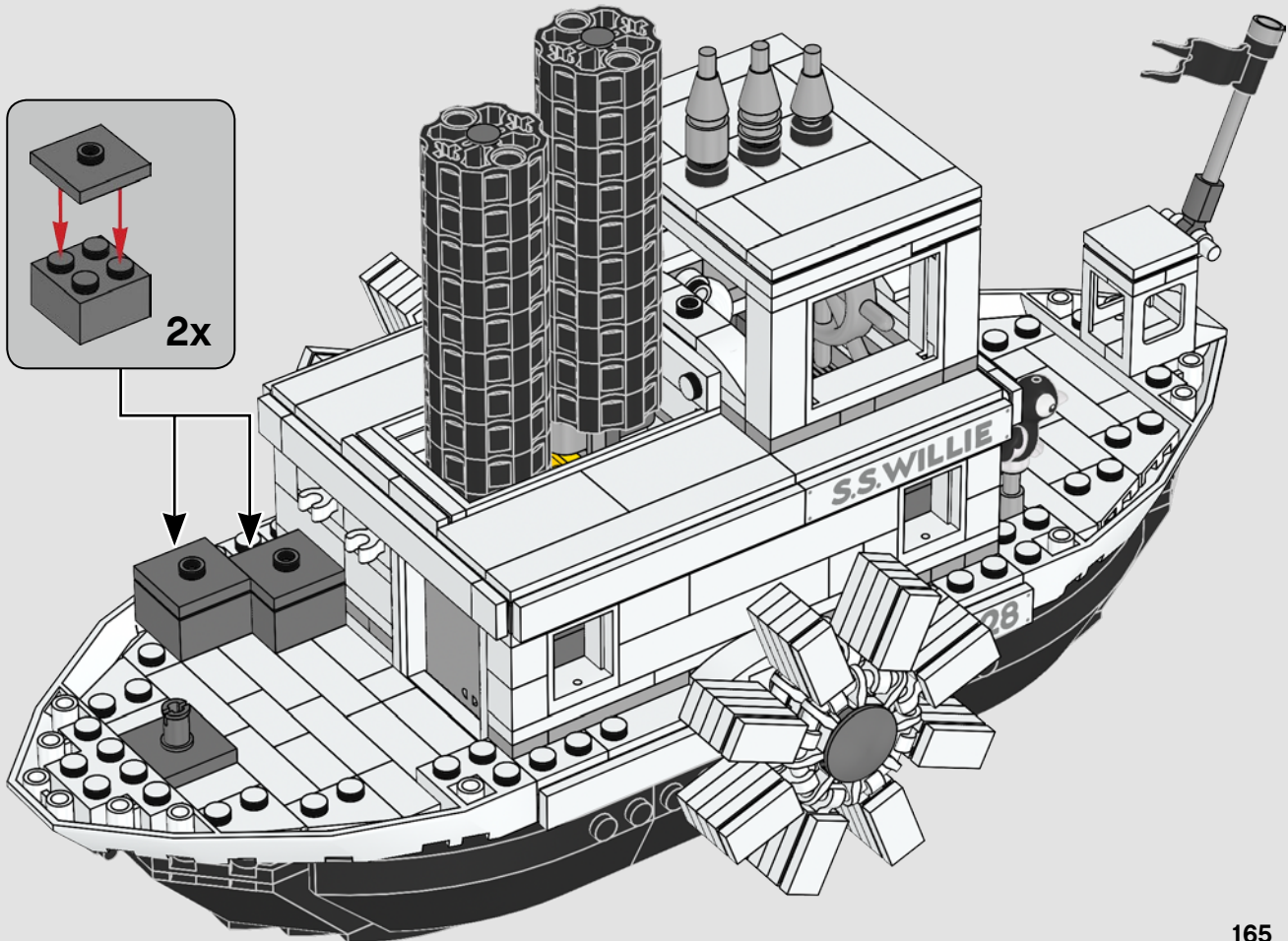

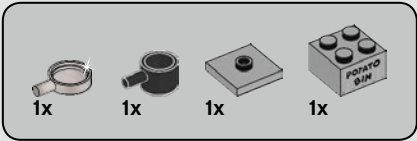

164

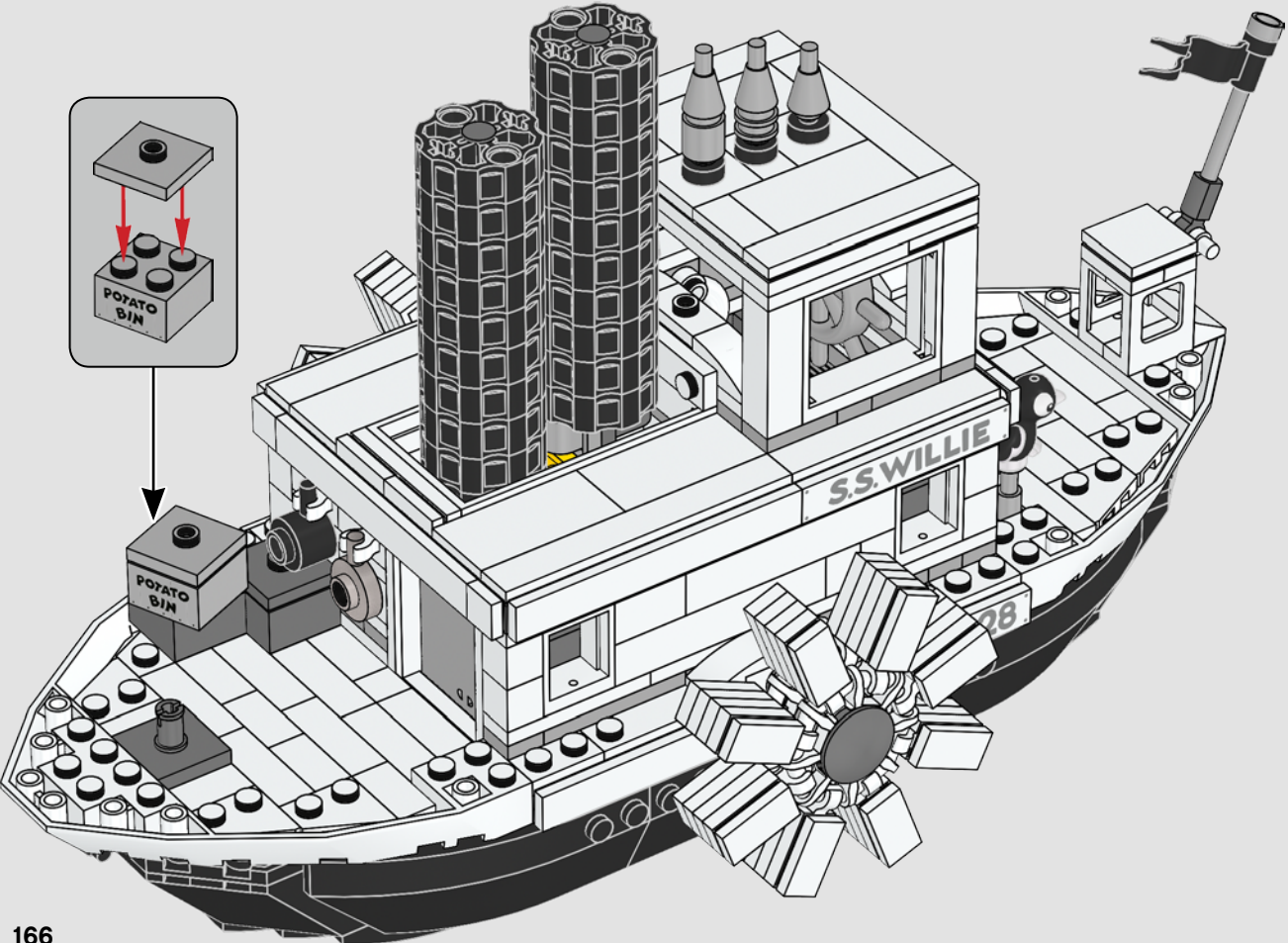

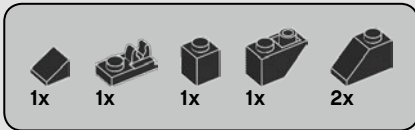

165

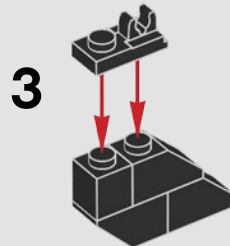
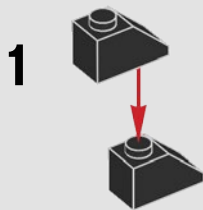

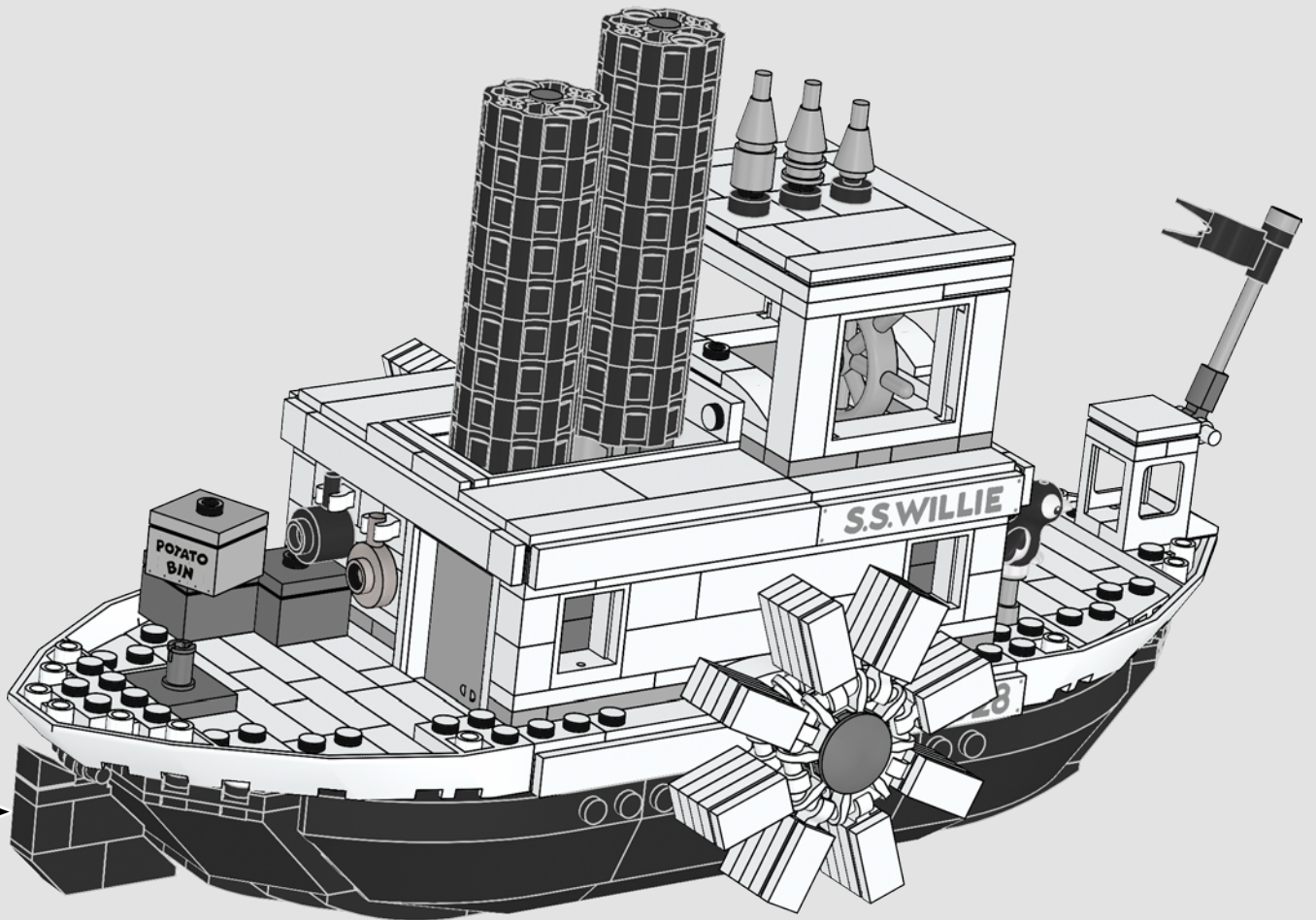

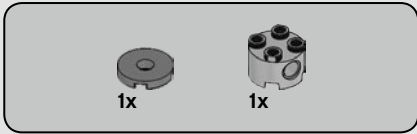
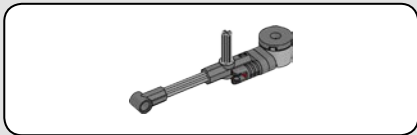

166

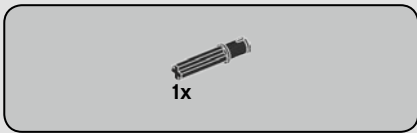
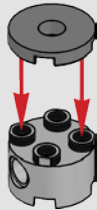

167

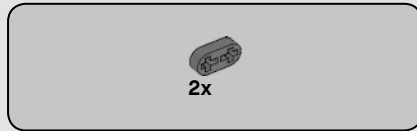
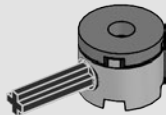

168

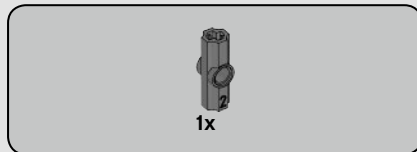
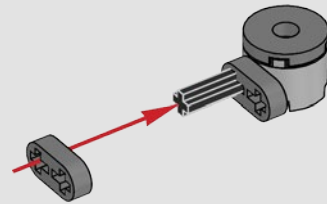

169

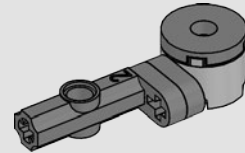

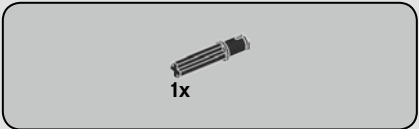

170

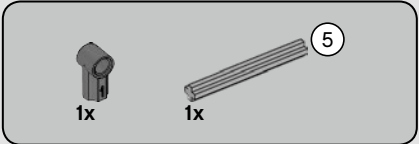
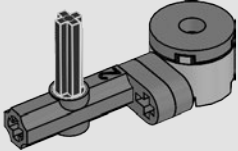

171

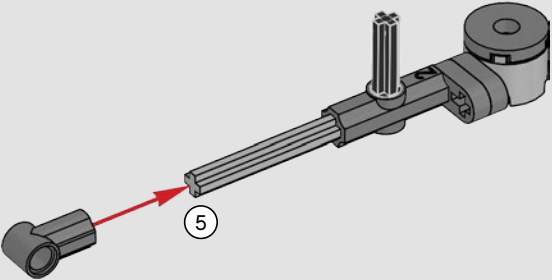

170

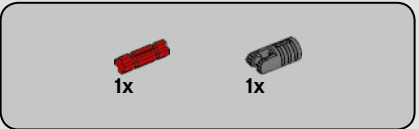

172

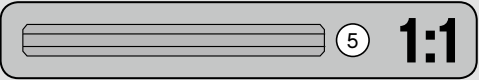
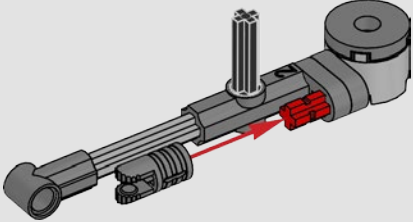

173

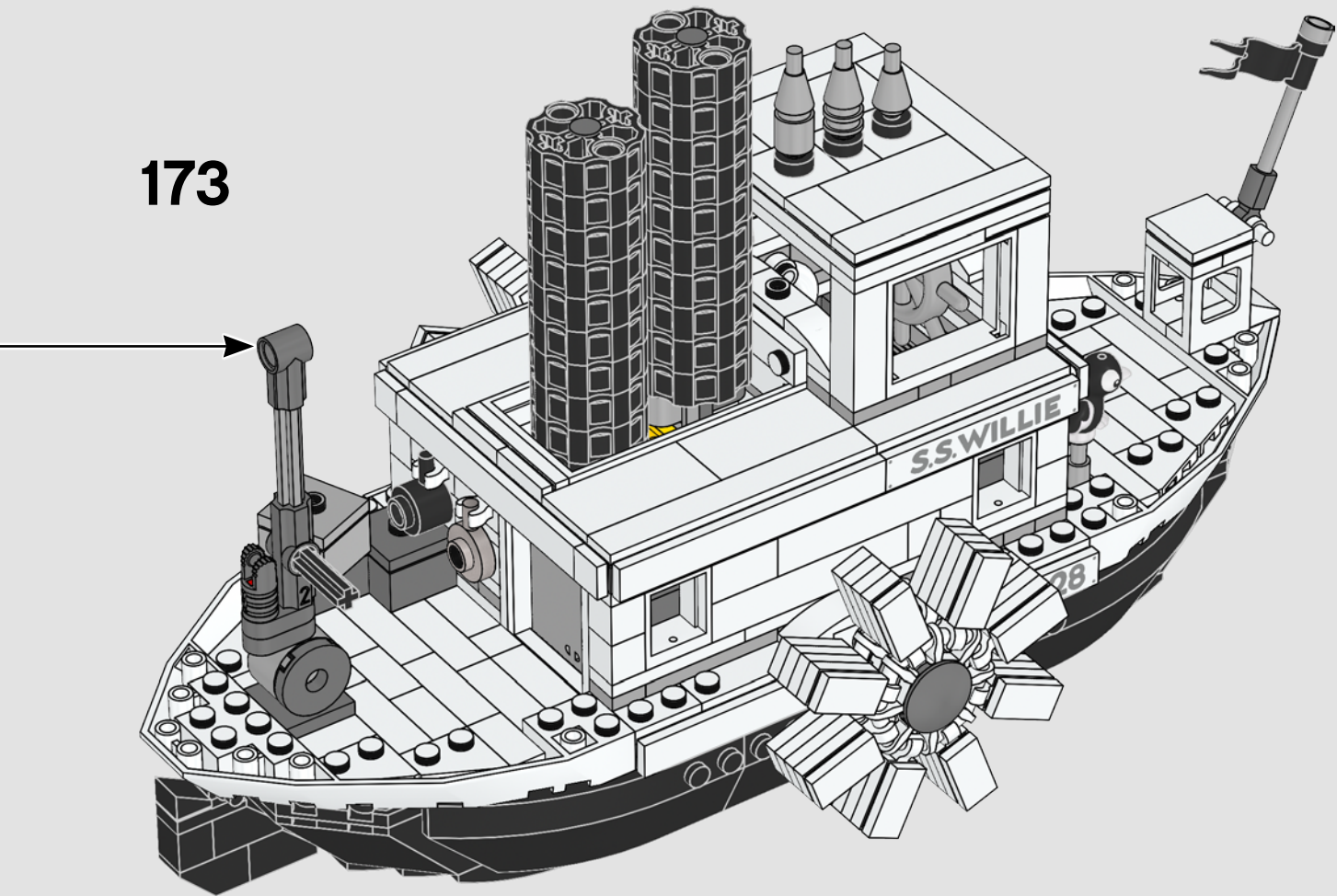

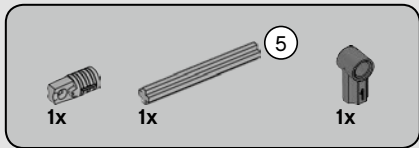

174

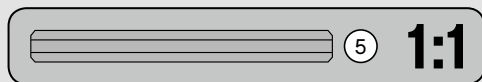
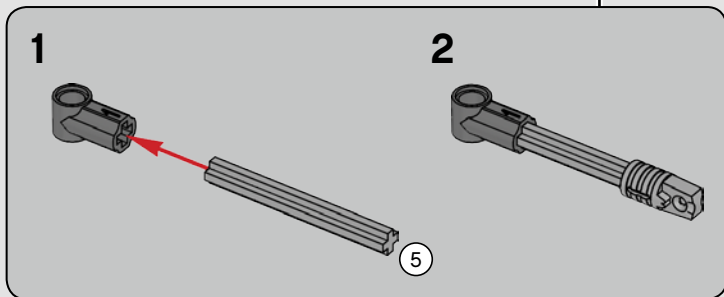
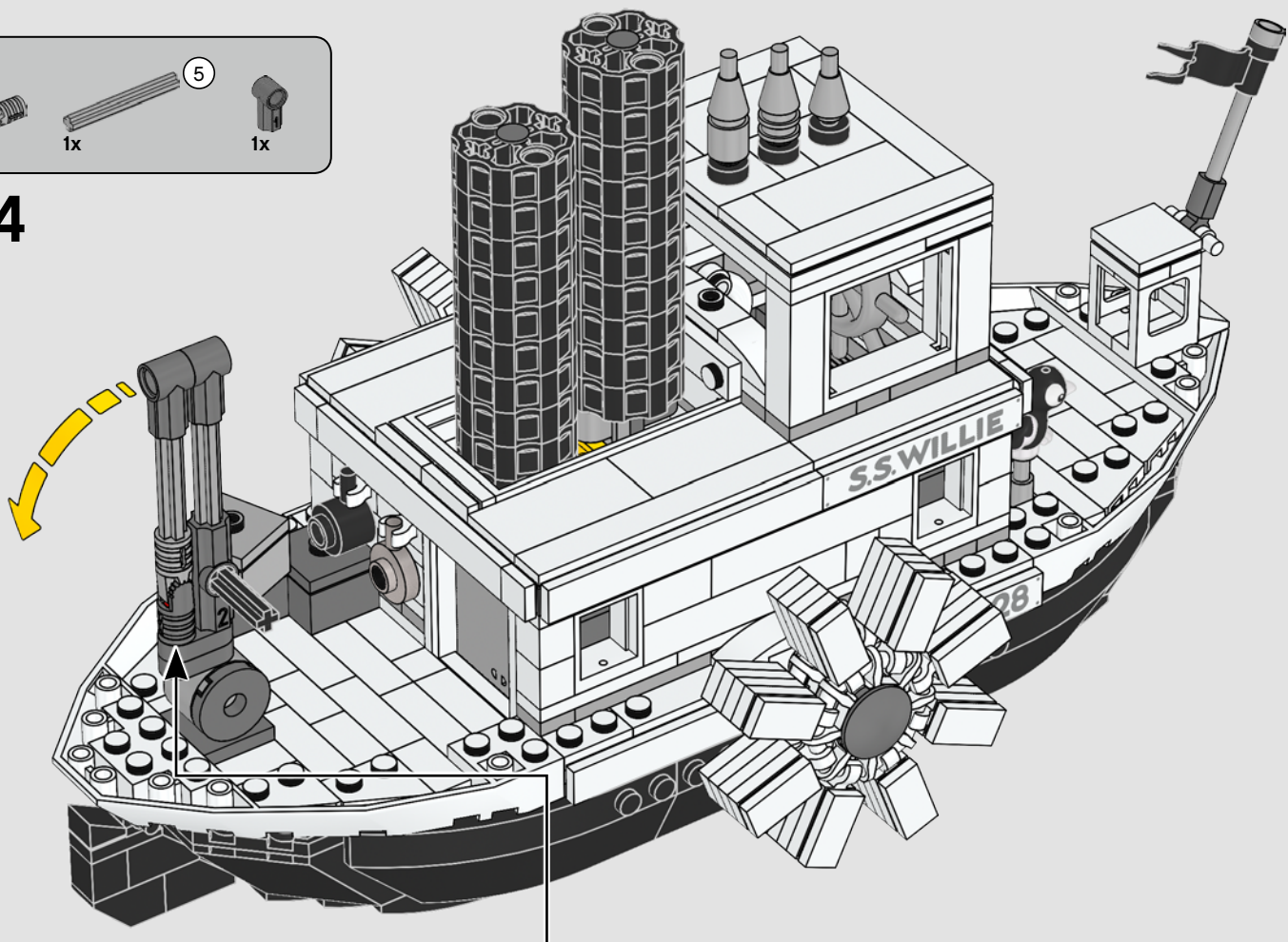

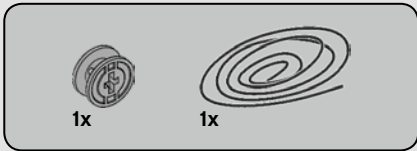

175

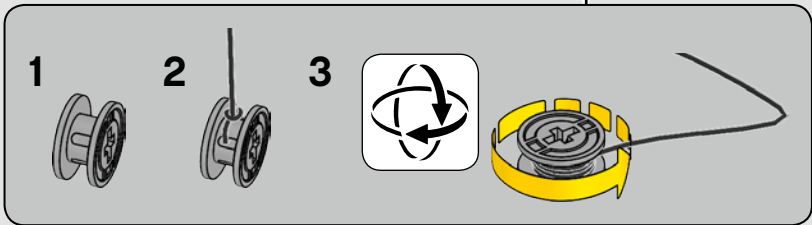
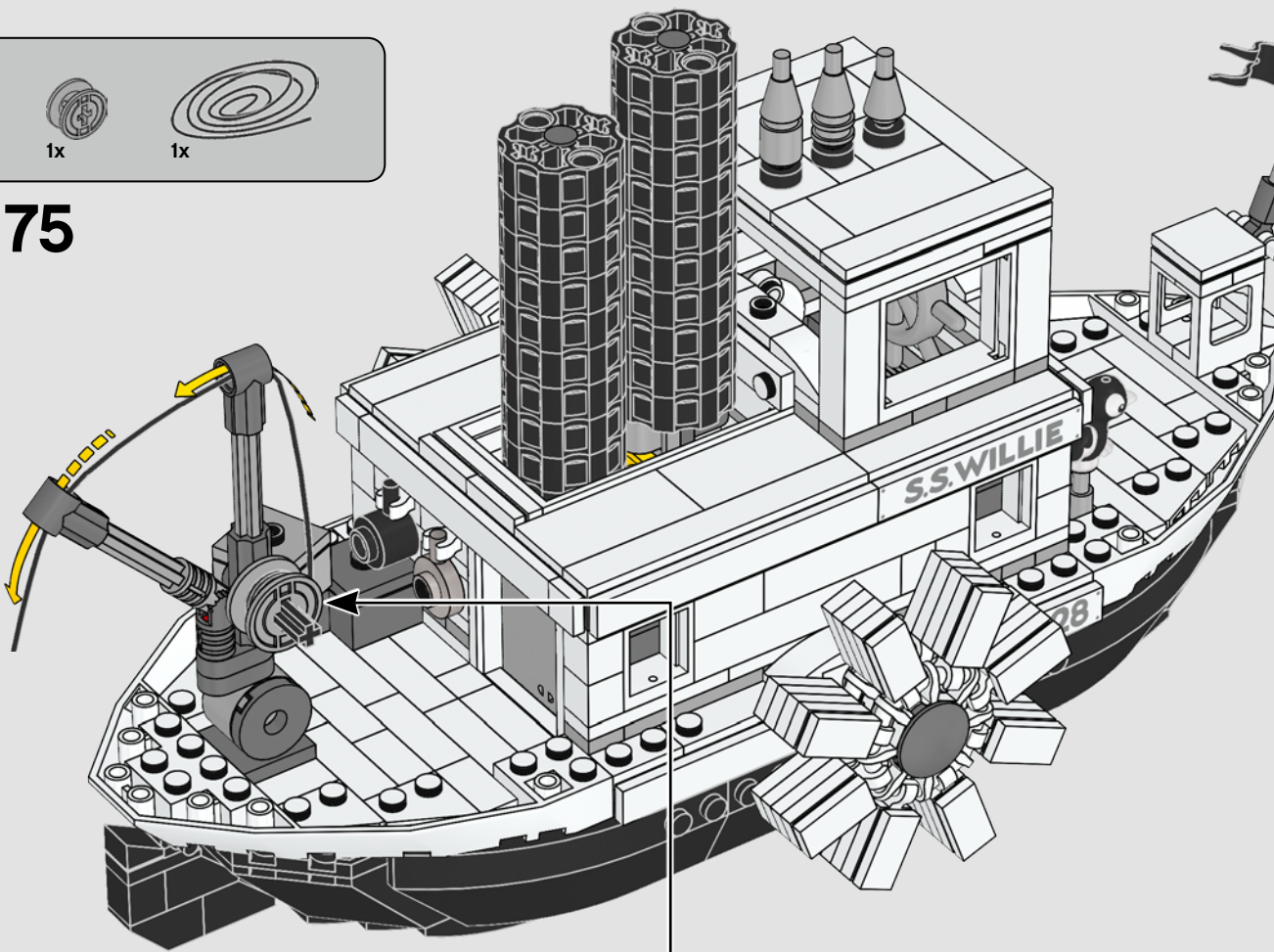

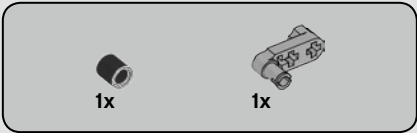

176

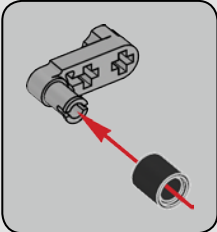
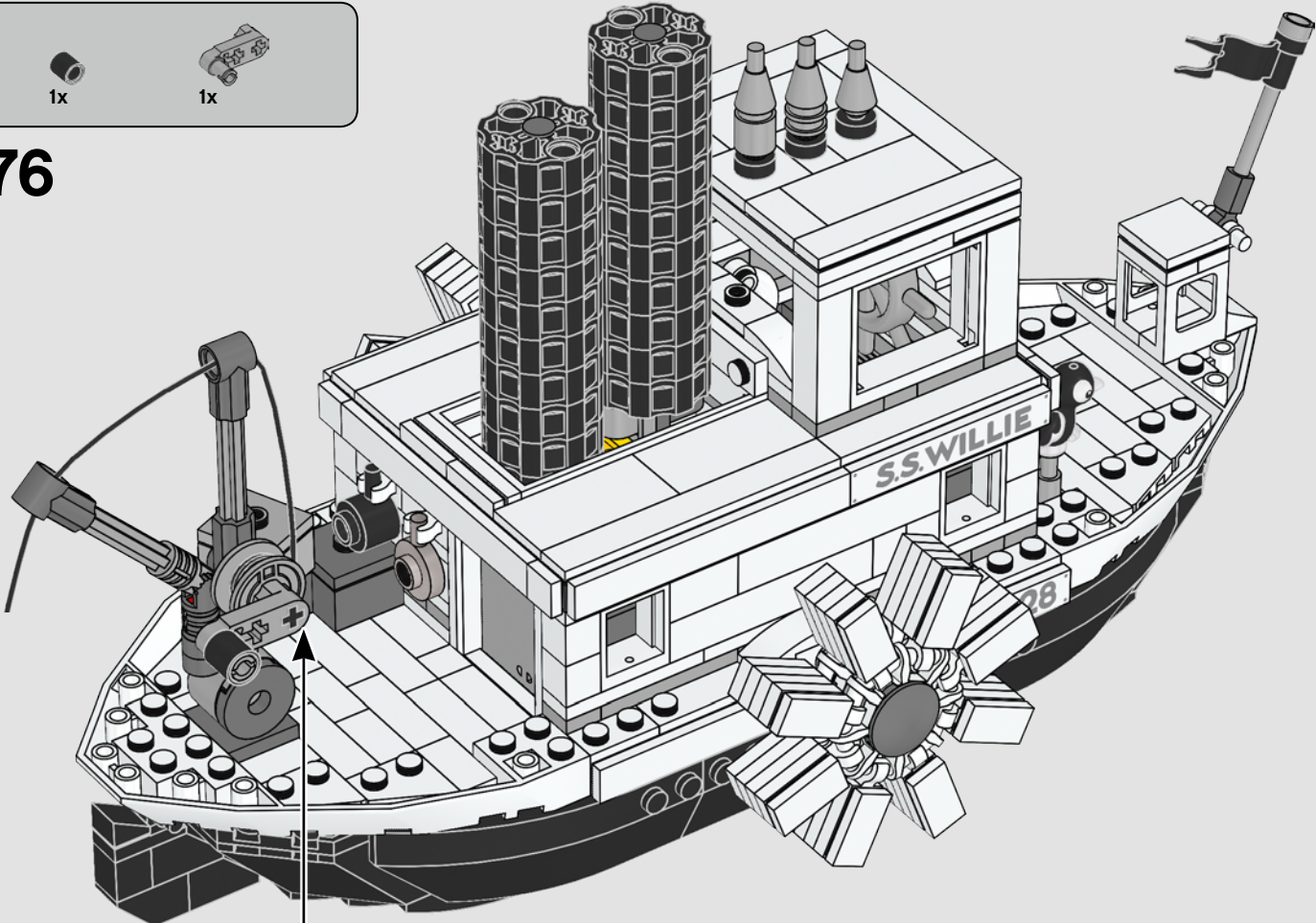



177

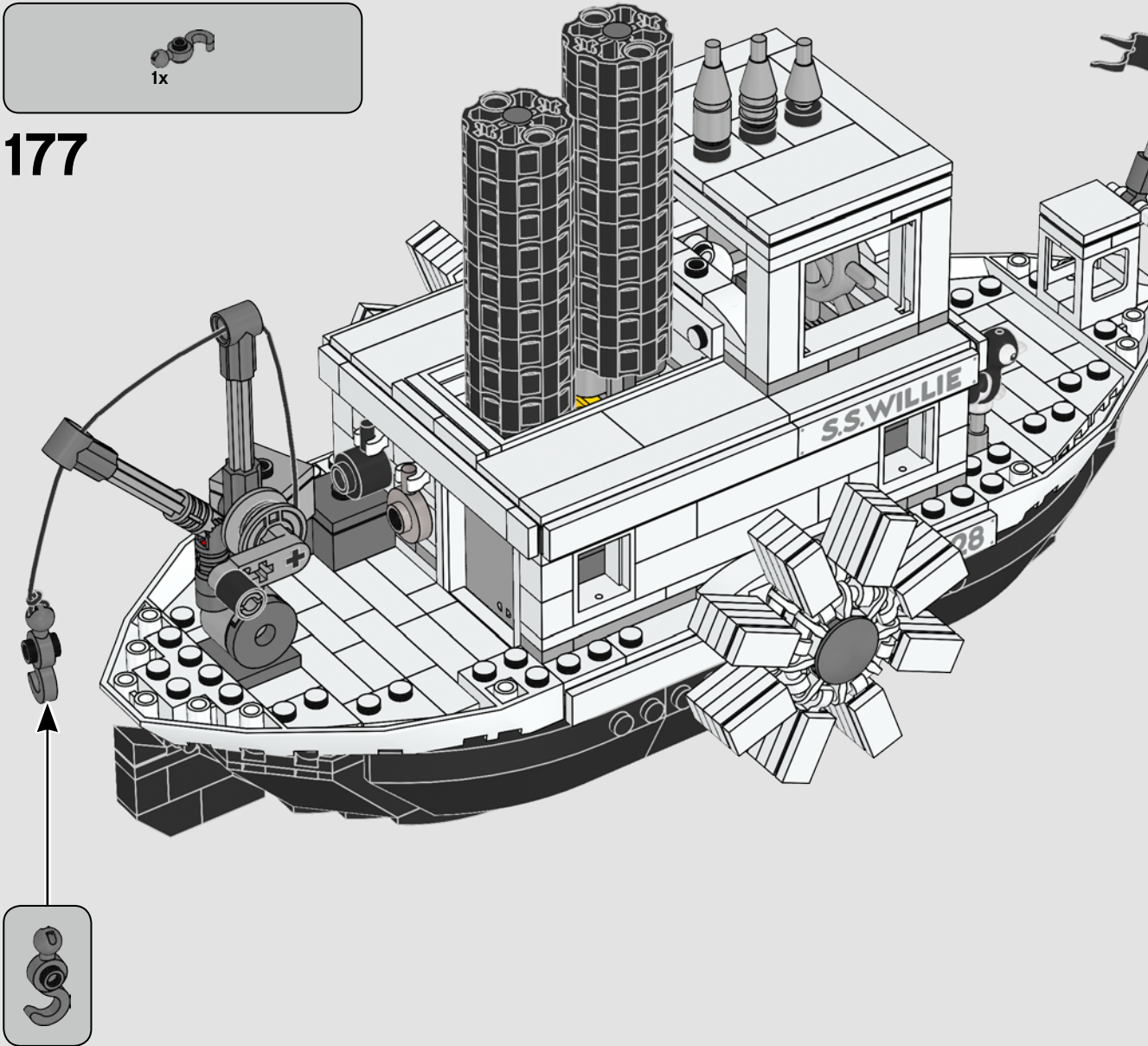



1x

178

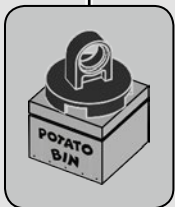
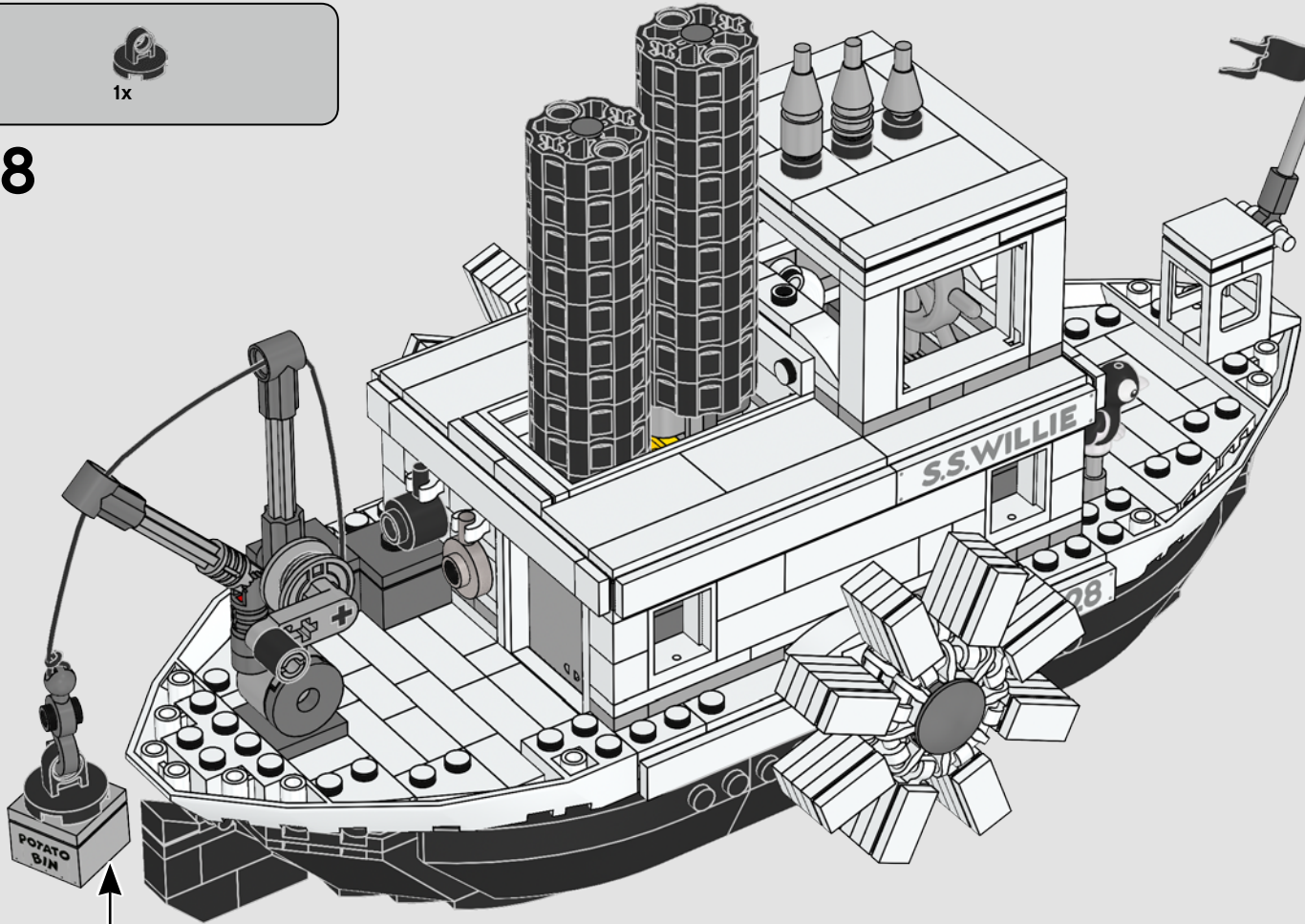

176

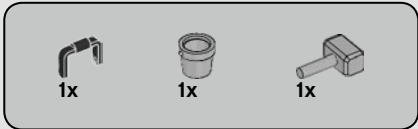

179

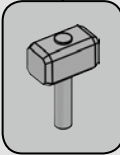
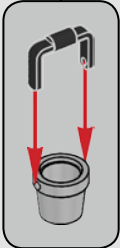
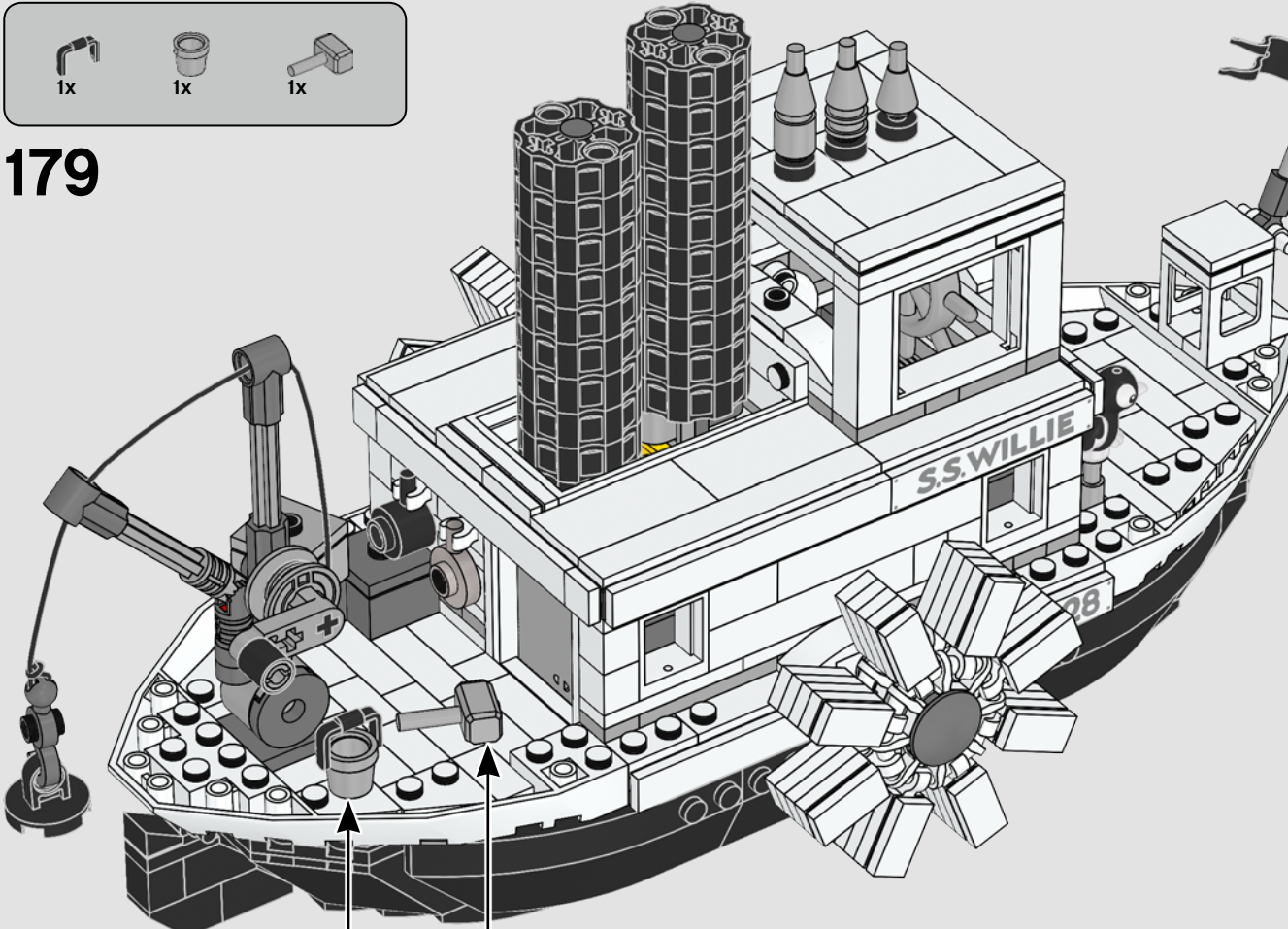



IDEAS

GATHER SUPPORT
OBTIENS DE L'APPUI
OBTÉN APOYOS



SHARE YOUR IDEA
PARTAGE TON IDÉE
COMPARTE TU IDEA

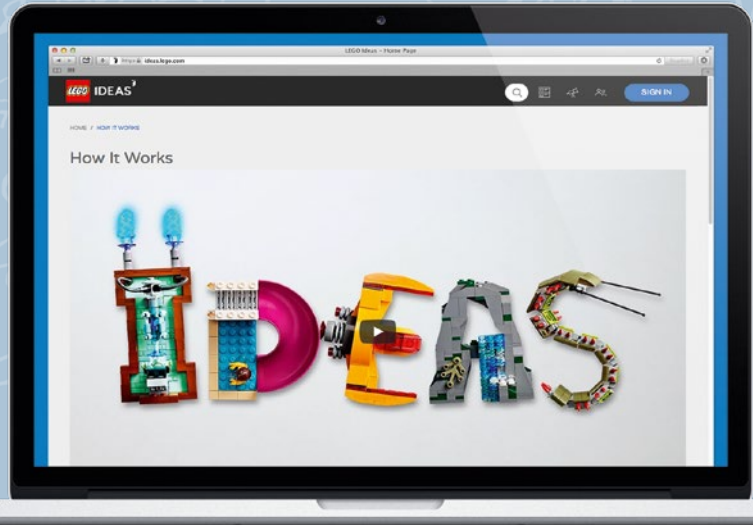

NEW LEGO® PRODUCT
NOUVEAU PRODUIT LEGO®
NUEVO PRODUCTO LEGO®

LEGO® REVIEW
EXAMEN LEGO®
REVISIÓN DE LEGO®



THE FLINTSTONES and all related characters and elements © & ™ Hanna-Barbera. (s19)
© Disney

LEGO.com/ideas



1x 6273916
 4x 302401
 1x 4558952
 12x 307001
 3x 6055541
 15x 300501
 4x 6132203
 4x 6132204
 2x 4533763
 4x 4547489
 1x 6212049
 2x 4507685
 2x 6051511
 2x 6058177

49x 302301
 5x 370001
 4x 6034044
 27x 306901
 6x 4521210
 4x 6013484
 5x 6070698
 2x 4297083
 1x 4140583
 32x 4535737
 1x 6273668
 10x 6218822
 2x 6126046
 1x 306801

4x 300301
 4x 242001
 1x 4208160
 1x 6195371
 3x 362201
 3x 6273663
 20x 4558168
 1x 6273932
 4x 302101
 4x 6009016
 1x 6245442
 1x 6245354

13x 4597131
 8x 371001
 2x 6023806
 2x 6254518
 3x 4530590
 2x 4530590
 1x 6262945
 1x 6273949
 6x 4560178
 2x 6273665
 1x 6192352

4x 366601
 8x 663601
 4x 6195358
 4x 4181142
 1x 346001
 6x 416201
 2x 300801
 2x 303201
 1x 6001831
 4x 6057460
 2x 447701

1x 303601
 2x 244501
 2x 6205090
 2x 306923
 2x 302223
 2x 6196596
 2x 370123
 2x 346023
 2x 303423
 2x 389523

2x 407021
 3x 4227155
 1x 4142865
 2x 4513174
 4x 235721
 4x 6118830
 2x 4141811
 1x 243121
 2x 300121
 3x 346021
 2x 303421

9

2x
4666579

2x
4109995

6x
4118866

2x
4181134

18x
302324

2x
302124

2x
300224

8x
374724

4x
366624

1x
6130010

2x
4514844

182

4x
6186675

1x
6203937

1x
6121485

1x
4504382

1x
300526

1x
6245281

2x
403226

1x
6010831

1x
452926

1x
4598528

1x
366526

2x
4121966

11x
302326

2x
4140588

2x
242026

6x
6089119

4x
4541455

20x
6186133

2x
6245788

1x
4636201

1x
6274813

4x
243126

16x
6037746

2x
4515350

4x
4227684

2x
302026

4x
329726

1x
6179847

4x
366626

2x
4160108

1x
6187587

2x
4160130

2x
370726

2x
6271278

2x
6270815

2x
4163334

2x
6271277

2x
6173129

1x
6057526

10x
4118782

2x
6249815

2x
6271130

9x
6248957

3x
4661486

1x
6254100

1x
4211412

3x
6167667

2x
6168647

2x
6275844

1x
6057487

7x
4211399

2x
4558953

4x
4533772

1x
4211679

4x
4211475

1x
6078985

3x
4211807

3x
4640536

8

5

4x
6043656

4x
4211388

1x
4521532

2x
6123809

2x
4216248

1x
4657366

1x
6004729

1x
6273212

1x
4563045

1x
6126082

1x
6273669

2x
6045988

2x
4211815

6x
4654577

3x
4211429

2x
6169980

1x
6278555

2x
4211445

1x
4211473

2x
4211639

3x
4211385

1x
6079461

6x
6102575

1x
4211425

1x
4251149

2x
4617862

4x
6135494

4x
6159763

10x
4569058

20x
4157120

2x
4106356

2x
4143953

1x
6015890

1x
4289542

1x
6179648

2x
4210658

2x
6012451

2x
4210980

1x
4210695

3x
6055313

2x
4278274

4x
6039479

2x
4210763

1x
4212529

2x
6126083

1x
4211129

8x
4211109

2x
4211060

8x
6015356

1x
6133119

2x
4499858

1x
6274730

1x
4624615

1x
6273702

1x
6274725

Customer Service
Kundenservice
Service Consommateurs
Servicio Al Consumidor

LEGO.com/service or dial

🇧🇪 🇩🇪 🇫🇷 🇮🇹 🇯🇵 🇰🇷 🇸🇪 🇸🇯 🇺🇰 🇺🇸
: 00800 5346 5555
: 1-800-422-5346



IDEAS

Do you like this LEGO® Ideas set?

The LEGO Group would like your opinion on the new product you have just purchased. Your feedback will help shape the future development of this product series.

Please visit:

[LEGO.com/productfeedback](https://www.lego.com/productfeedback)

By completing our short feedback survey, you will be automatically entered into a drawing to win a LEGO® prize.

Terms & Conditions apply.

Aimez-vous cet ensemble LEGO® Ideas ?

Le Groupe LEGO aimerait connaître votre opinion sur le produit que vous venez d'acheter. Vos commentaires nous aideront à concevoir les futurs produits de cette gamme.

Veuillez visiter :

[LEGO.com/productfeedback](https://www.lego.com/productfeedback)

En remplissant ce court sondage sur le produit, vous serez automatiquement inscrit à un tirage au sort pour gagner un prix LEGO®.

Des conditions s'appliquent.



¿Te gusta este set LEGO® Ideas?

The LEGO Group quiere conocer tu opinión acerca del nuevo producto que acabas de comprar. Tus comentarios nos ayudarán a dar forma a los futuros productos de esta serie.

Visita:

[LEGO.com/productfeedback](https://www.lego.com/productfeedback)

Al contestar este breve cuestionario de opinión, participarás automáticamente en el sorteo de un producto LEGO®.

Sujeto a términos y condiciones.