



MINECRAFT

21253







LEGO® Builder



LEGO.com/sustainable-packaging



 ^{FR} **DONNEZ
OU
RECYCLEZ**  OU  OU 
ASSOCIATION MAGASIN DÉCHÈTERIE

Adresses sur quefairedemesdechets.fr

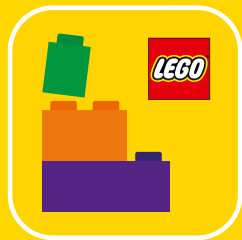

Q LEGO® Builder

BUILDER



Apple and the Apple logo are trademarks of Apple Inc., registered in the U.S. and other countries and regions. App Store is a service mark of Apple Inc. Google Play and the Google Play logo are trademarks of Google LLC. Tencent and the Tencent logo are trademarks of Tencent Inc.

Q [LEGO.com/devicecheck](https://lego.com/devicecheck)

EN Ask parents' permission before going online | **DE** Eltern um Erlaubnis bitten, bevor du online gehst | **FR** Demande l'autorisation d'un parent avant d'aller en ligne | **IT** Chiedi il permesso ai tuoi genitori prima di andare online | **ES** Pídeles permiso a tus papás antes de conectarte a Internet | **PT** Pede autorização aos pais antes de acederes online | **ZH** 上网前应先征得父母的同意 | **PL** Poproś rodziców o zgodę, zanim wejdziesz do Internetu | **CS** Než půjdeš na internet, požádej rodiče o svolení | **SK** Skôr než pôjdeš na internet, vypýtaj si povolenie od rodičov | **HU** Kérj szülői engedélyt, mielőtt online csatlakoznál! | **RO** Cere permisiunea părinților înainte de a te conecta online | **BG** Поискайте разрешение от родител, преди да влезете онлайн | **LV** Pirms došanās tiešsaistē palūdz atļauju vecākiem | **ET** Enne Interneti kasutamist küsi vanematelt luba | **LT** Prieš prisijungdami prie interneto, atsiklauskite tėvų

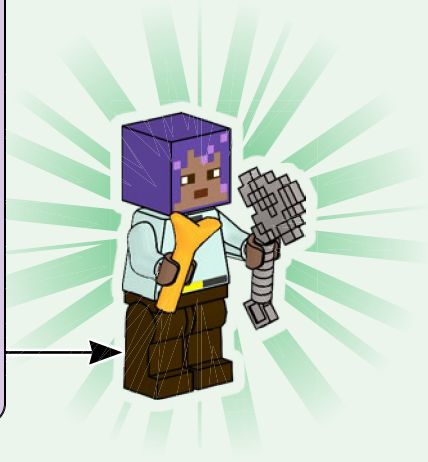
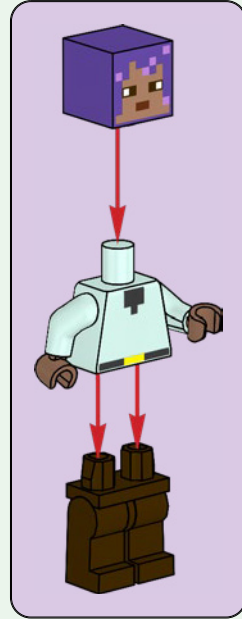

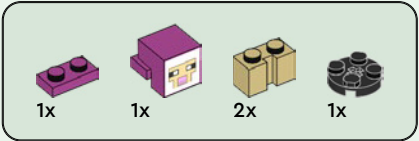

1



2

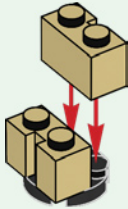

3



4

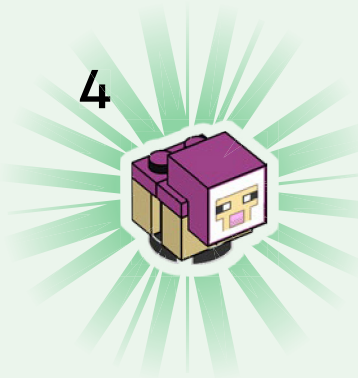

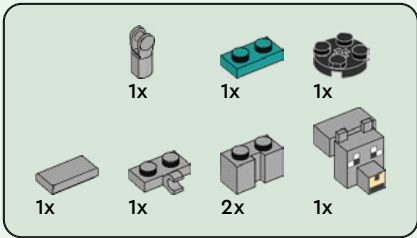
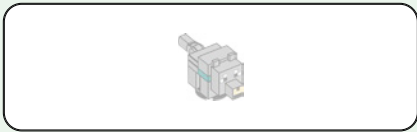

1



2

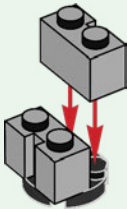

3

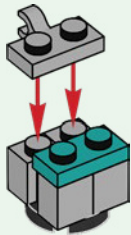

4

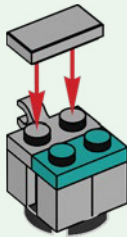

5

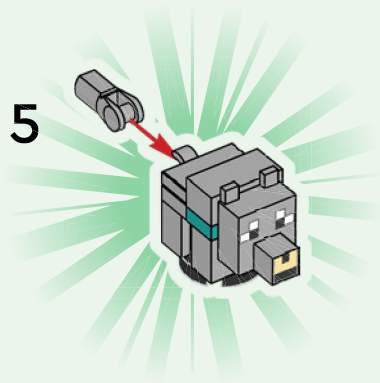

6



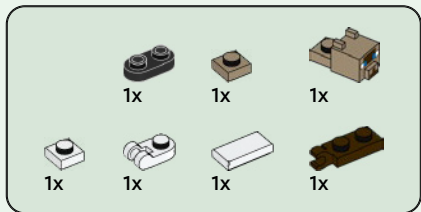

1



2

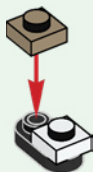

3



4

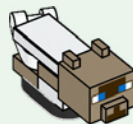

5

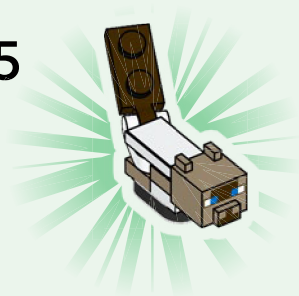

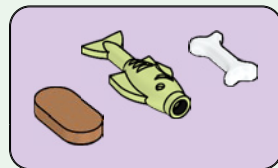
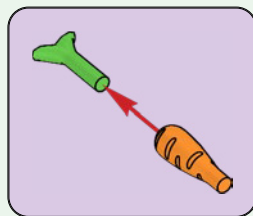
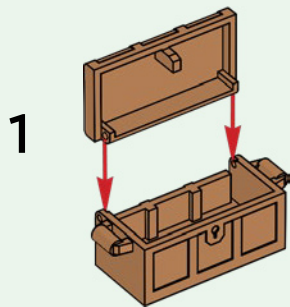
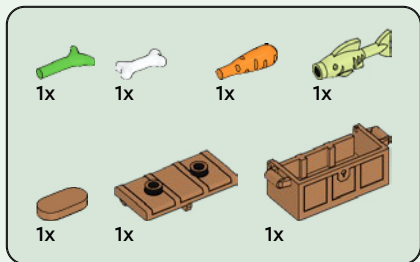

2

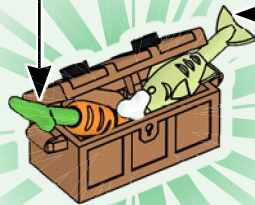



2x



2x



2x



2x



2x

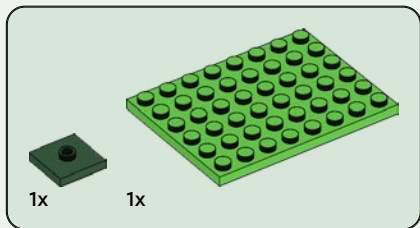
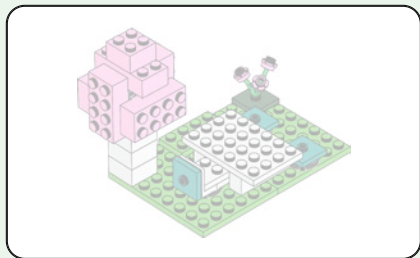

1

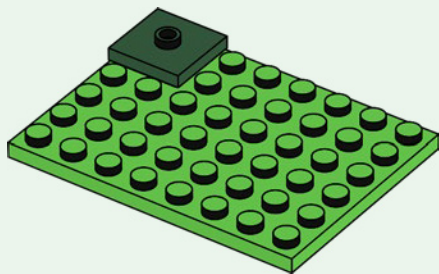

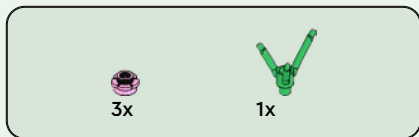

2

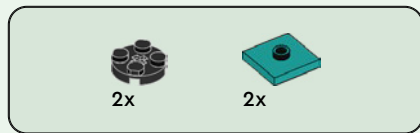
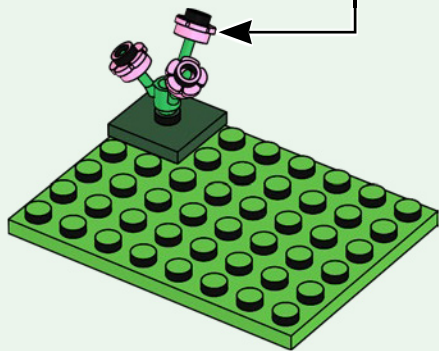
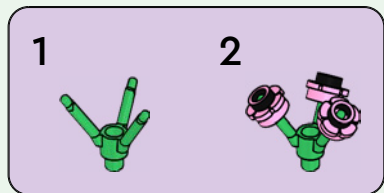

3

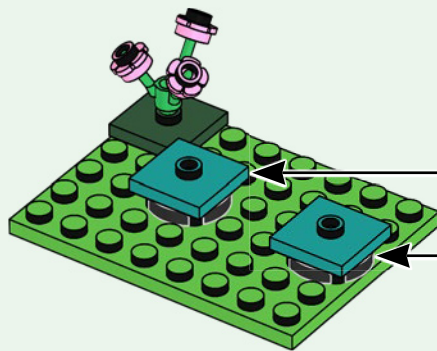
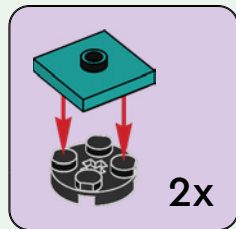

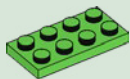

1x

4

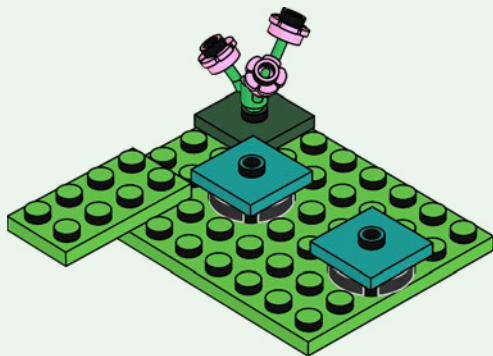

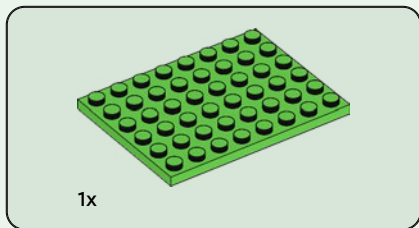

5

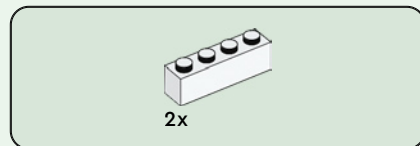
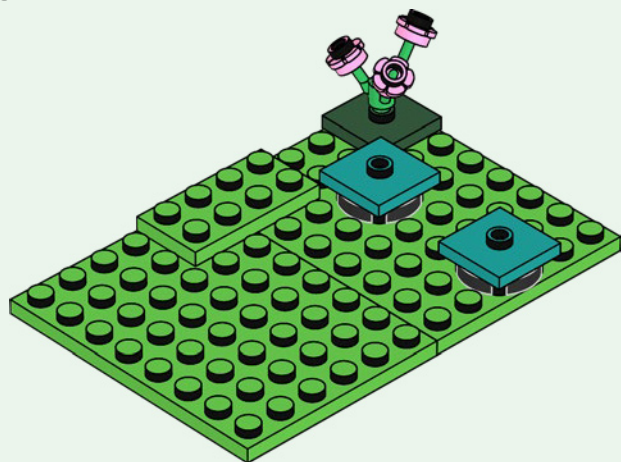

6

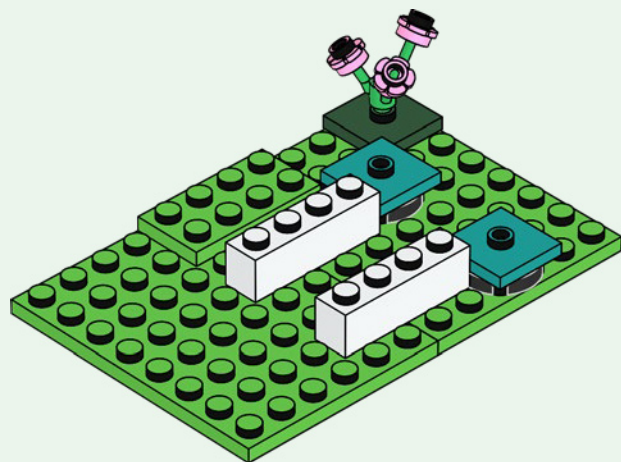

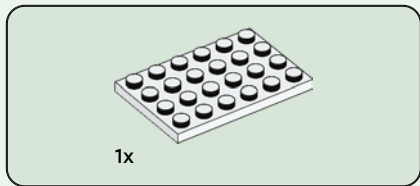

7

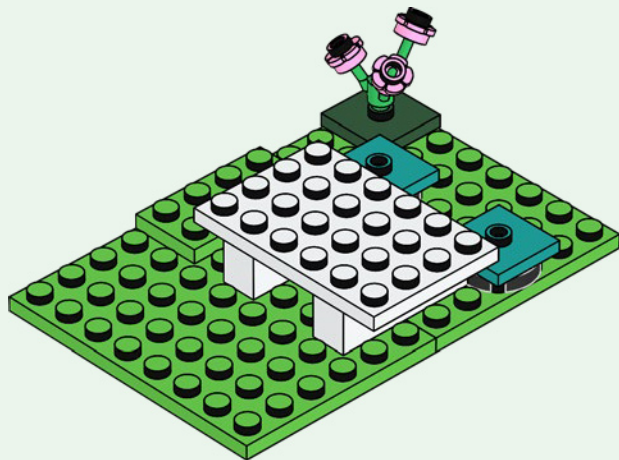

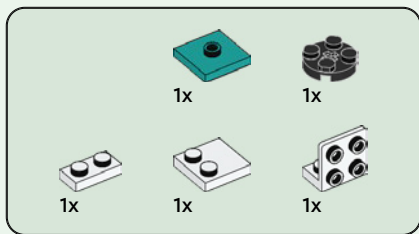

8

1



2



3

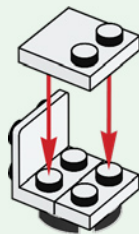

4

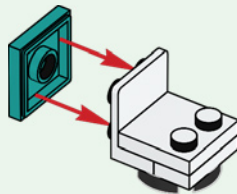

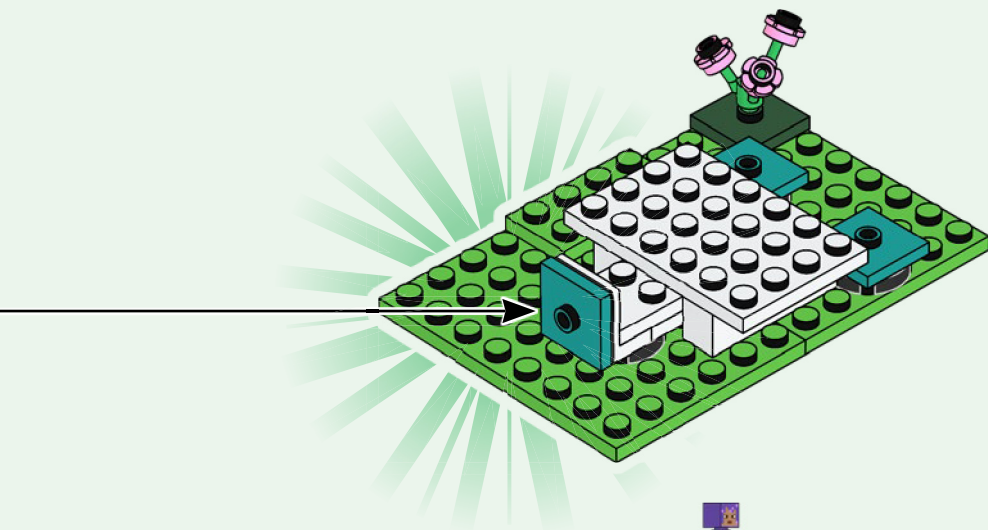

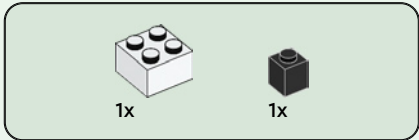
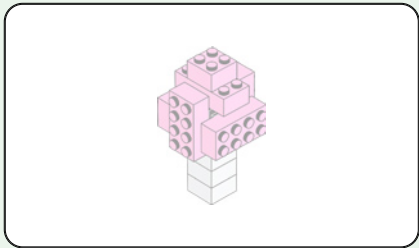

9

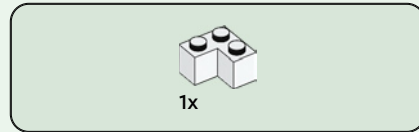
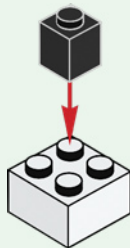

10

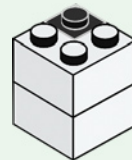



3x

11

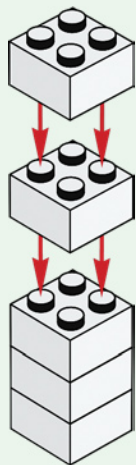

2x

12

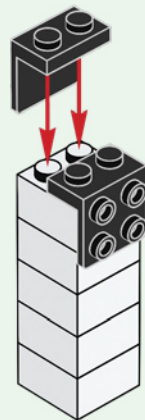



2x

13

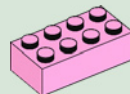
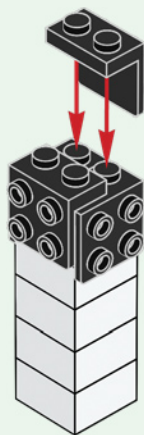

2x

14

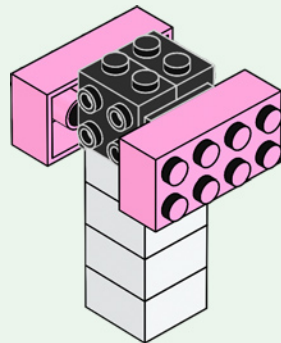

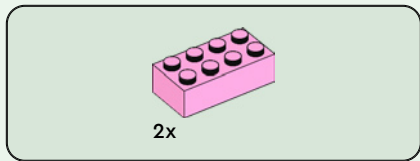

15

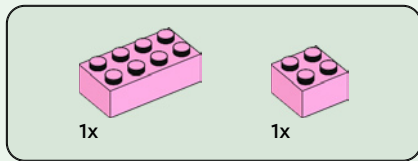
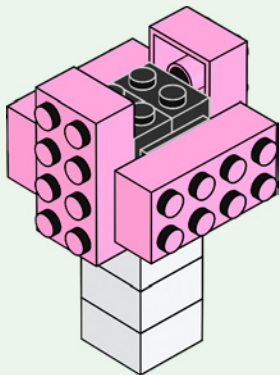

16

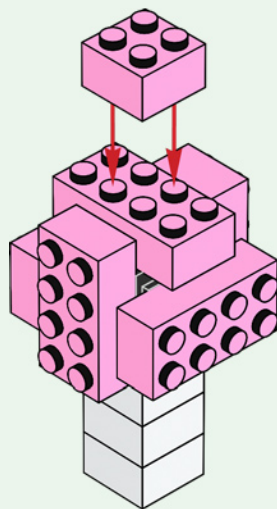

17

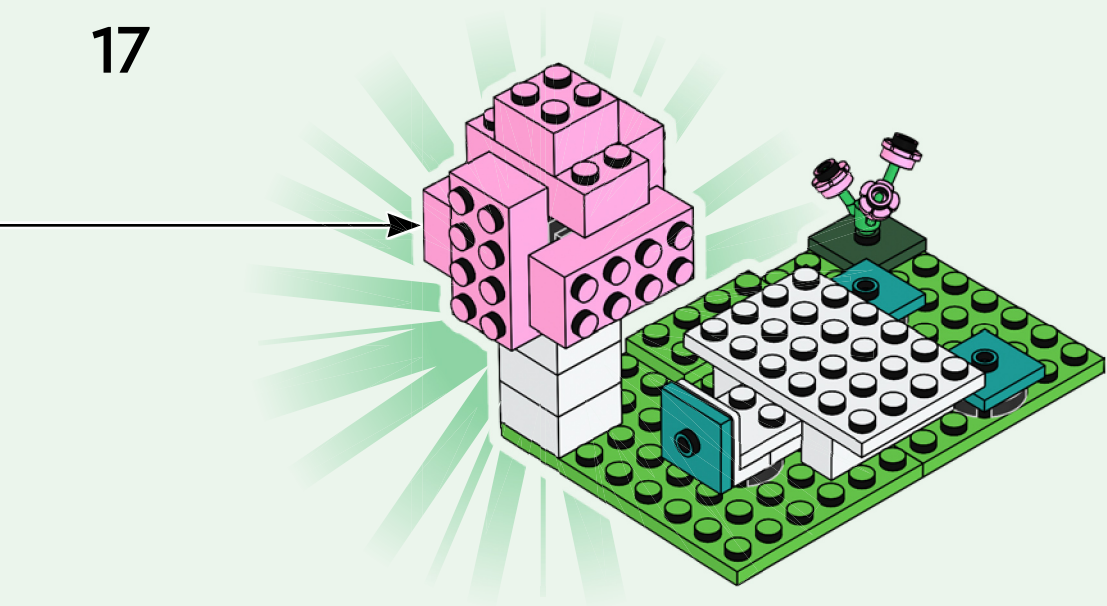

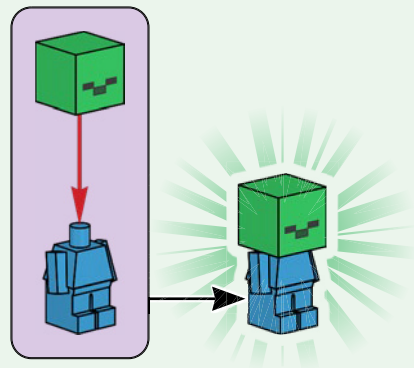



1x



1x



2x



1x



1x

1



2

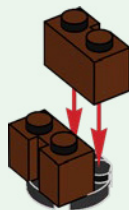

3

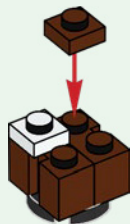

4

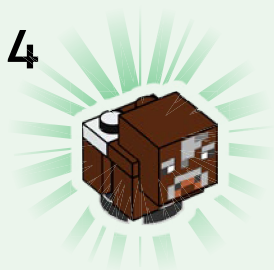



1x



1x



1x



1x

1



2



3

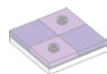

1x



2x



2x

1

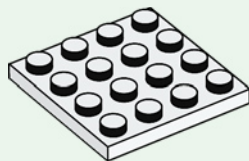

2

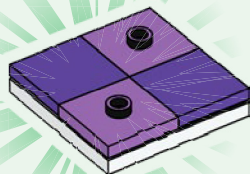

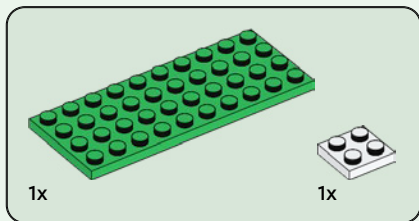
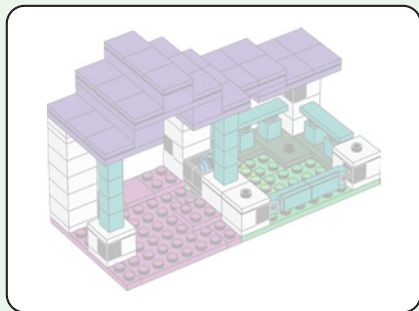

18

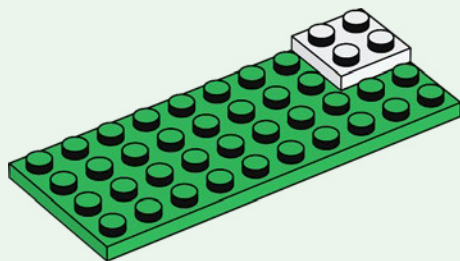



2x

19

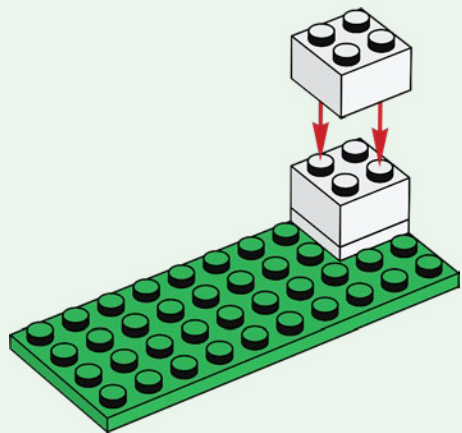

1x

20

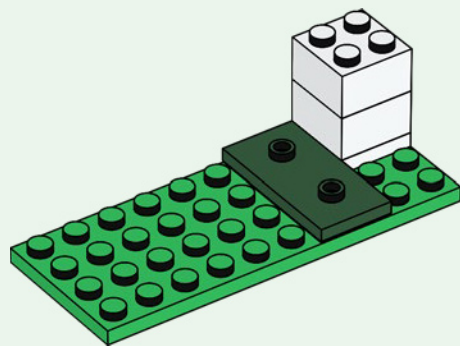

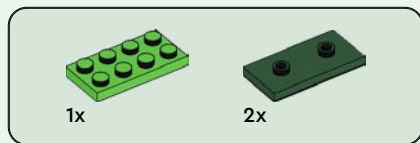

21

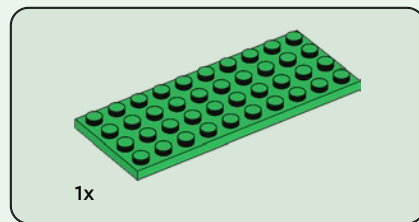
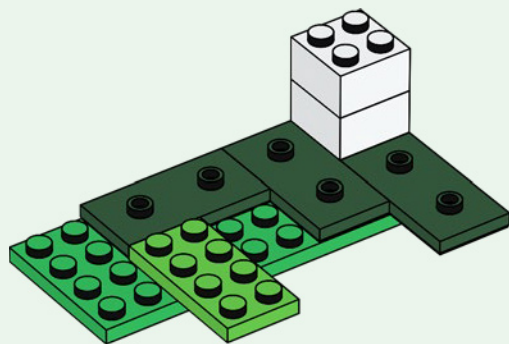

22

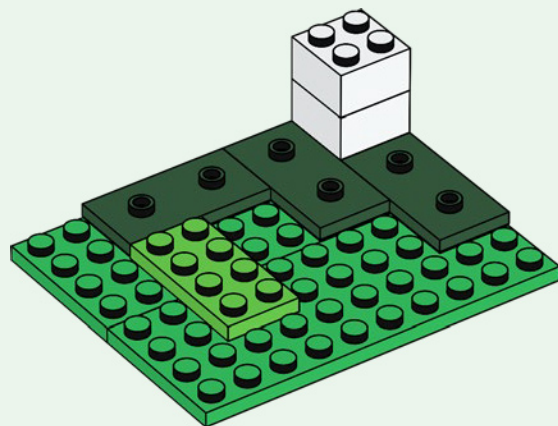



5x



5x

23



5x

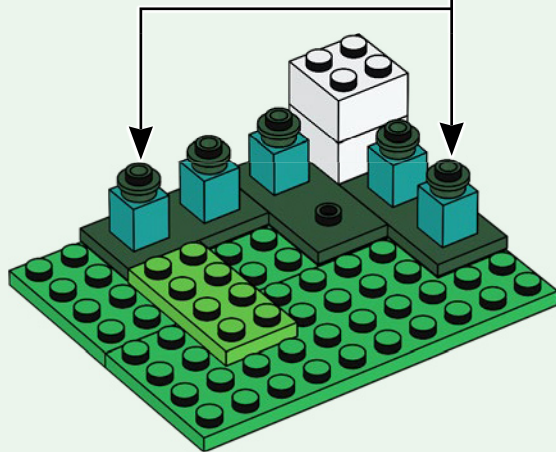

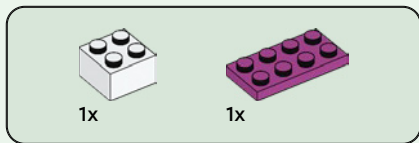

24

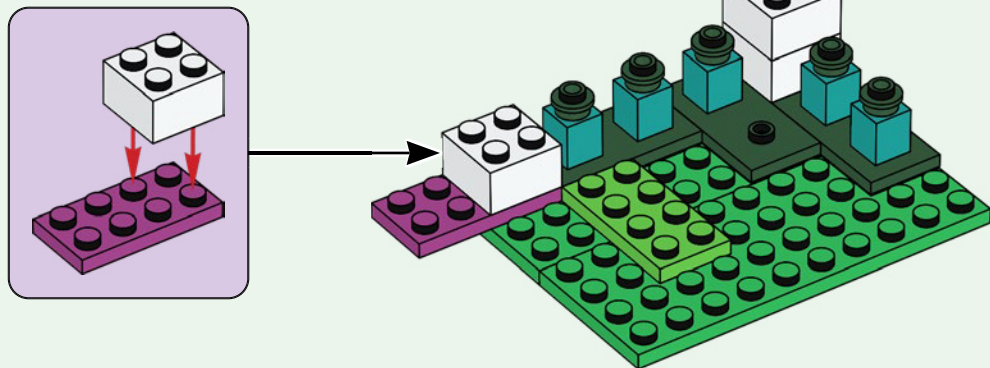

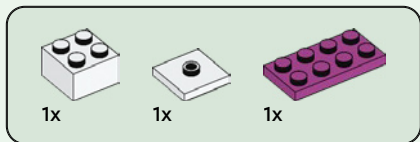

25

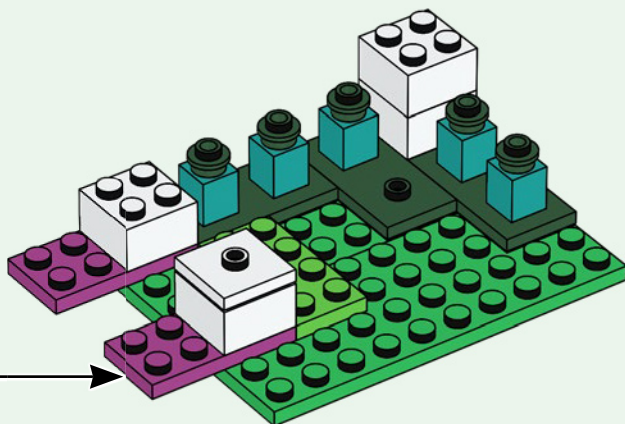
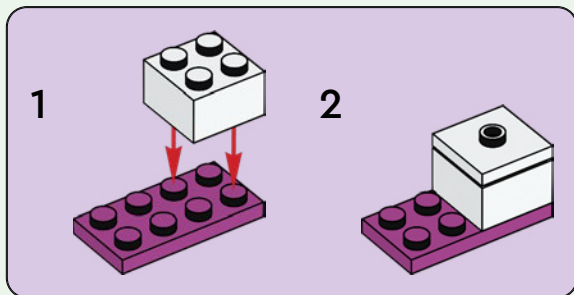

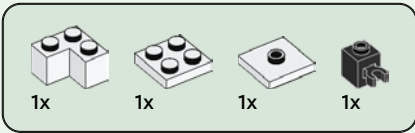

26

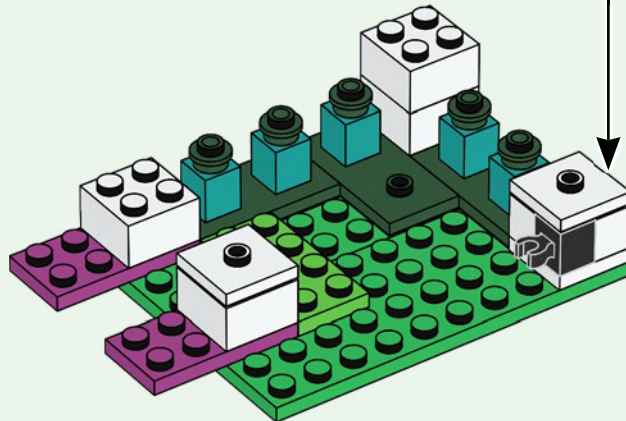
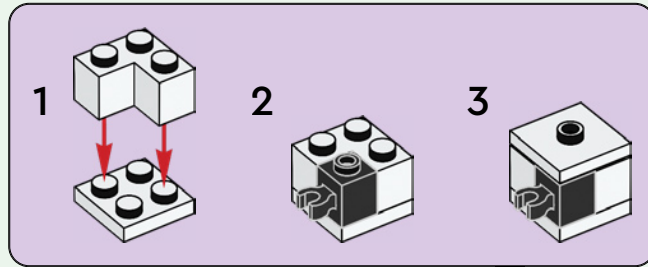

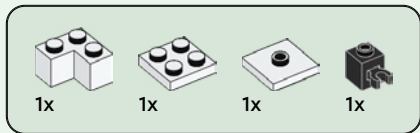

27

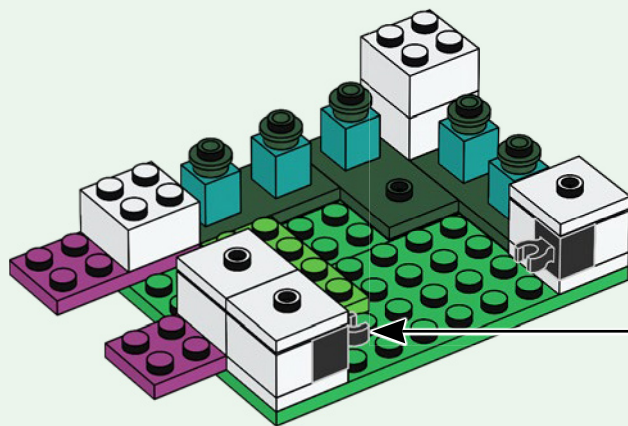
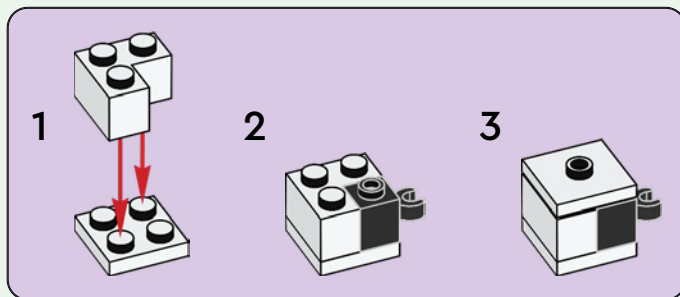

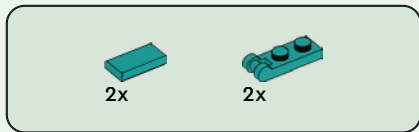

28

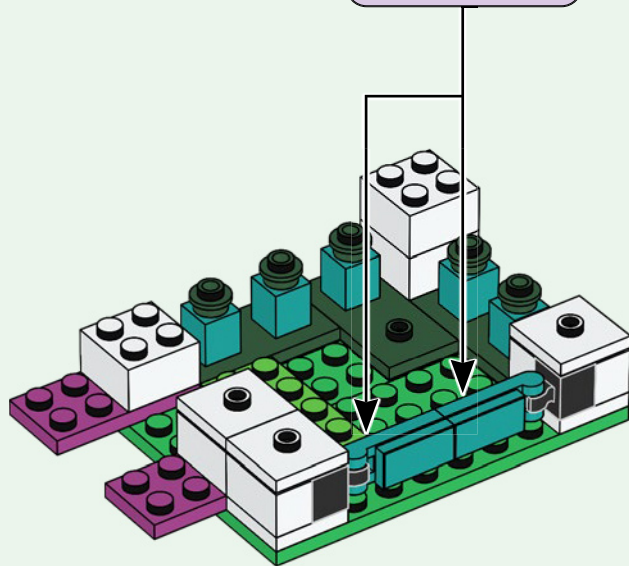
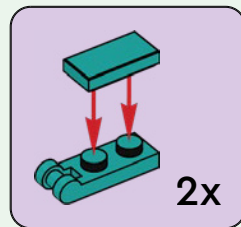



2x



1x



1x



2x

29

1

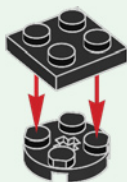

2

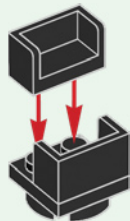

3

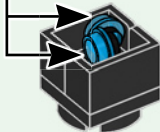

2x

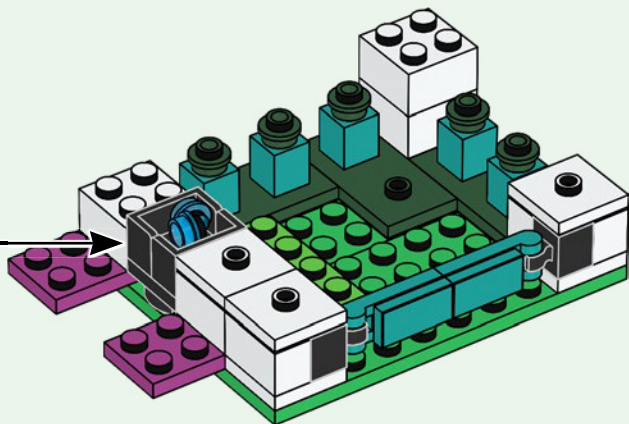

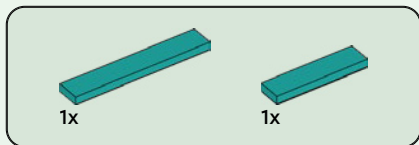

30

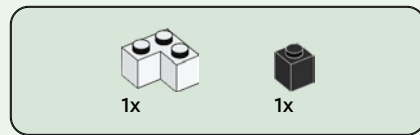
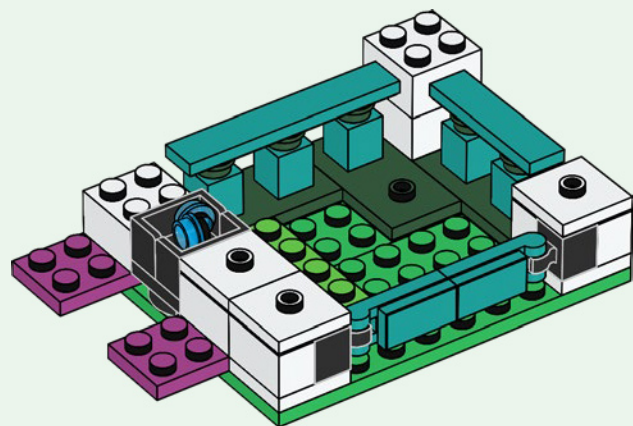

31

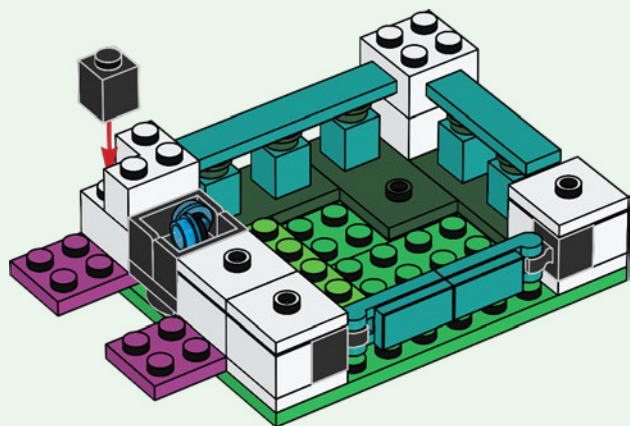



1x



1x

32

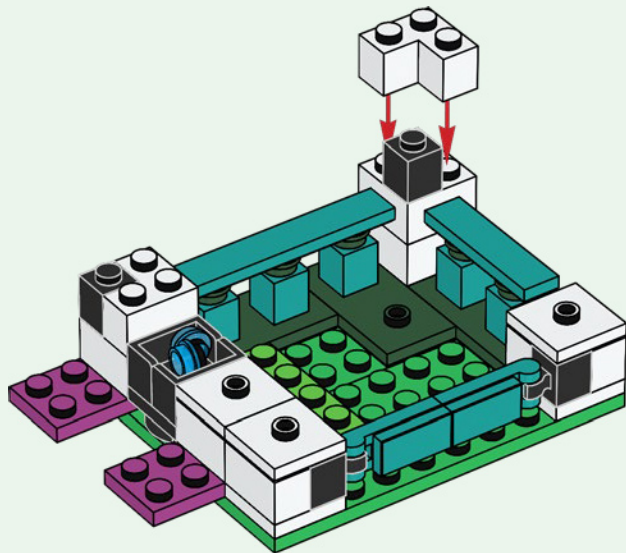



1x

33

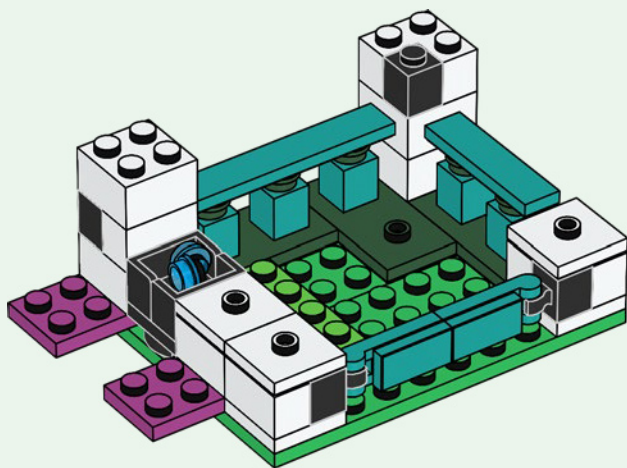

2x

34

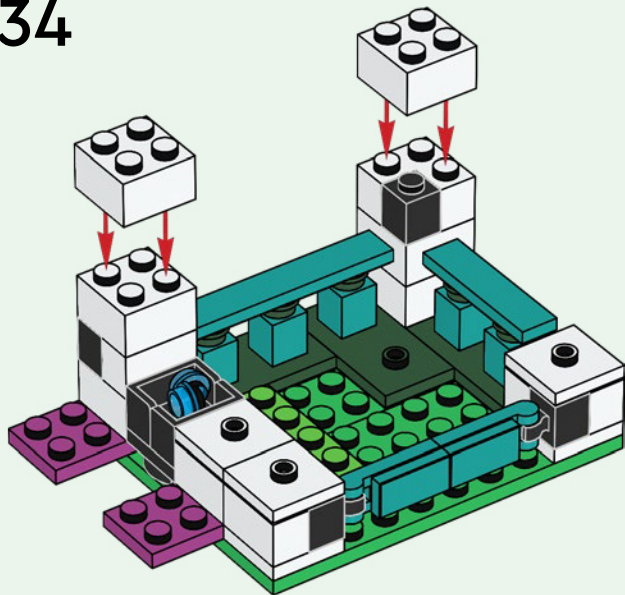

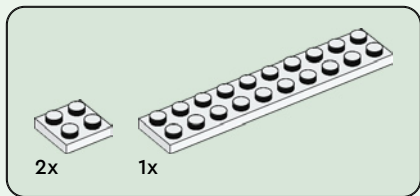

35

1

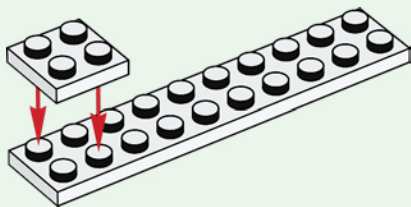

2

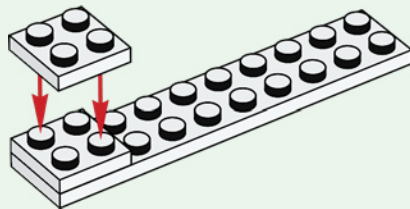

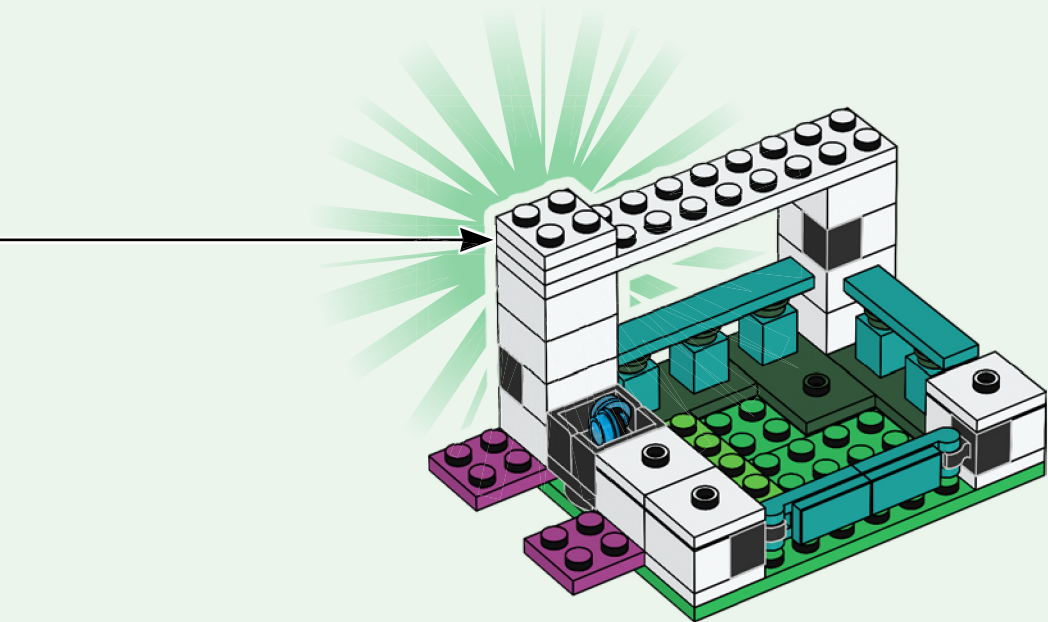

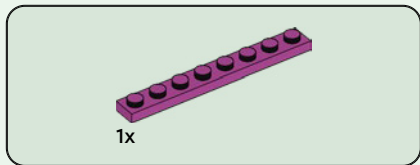

36

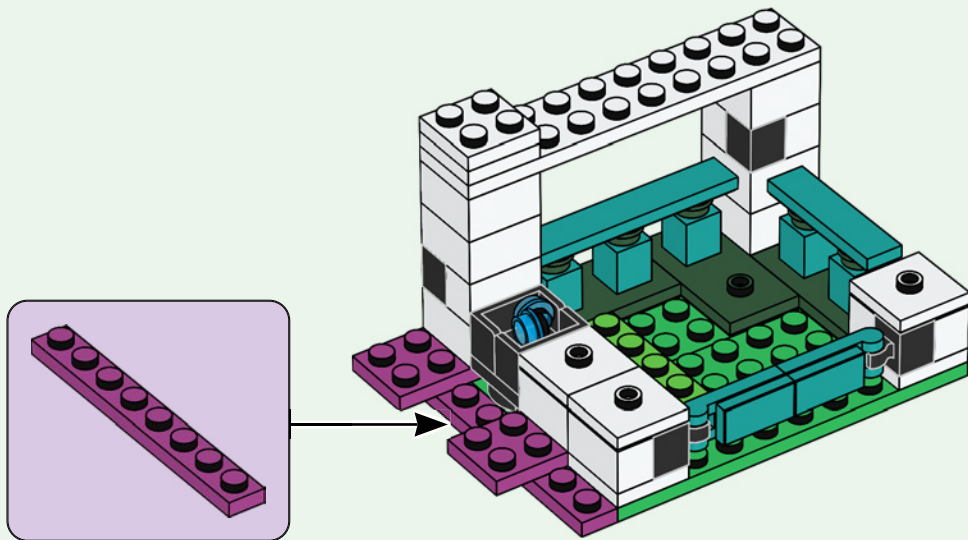

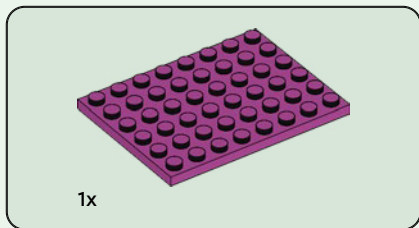

37

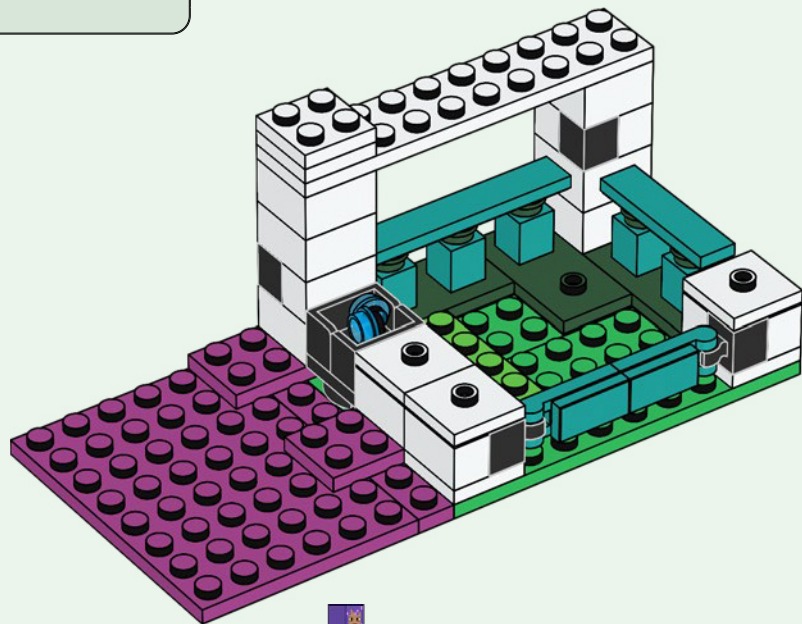



1x



2x

38

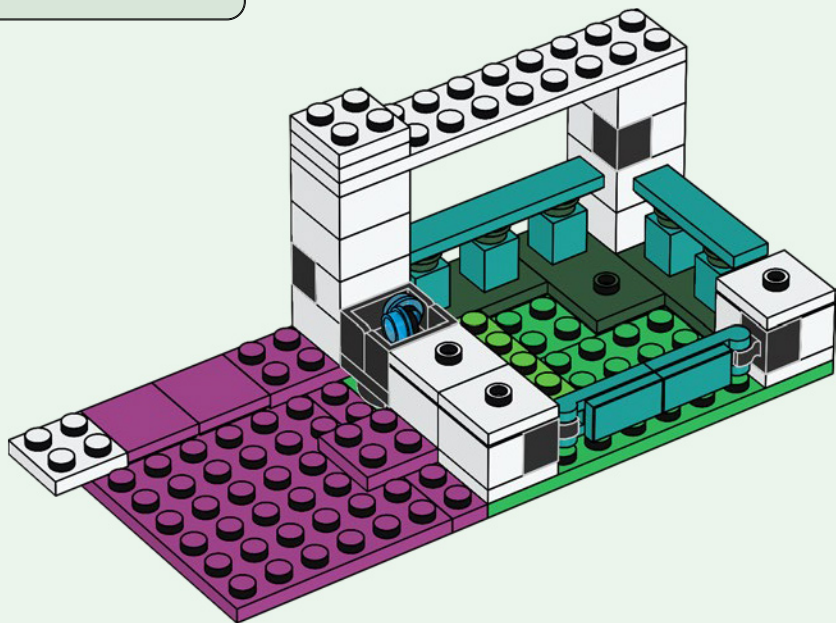

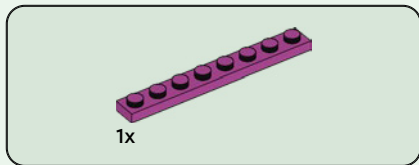

39

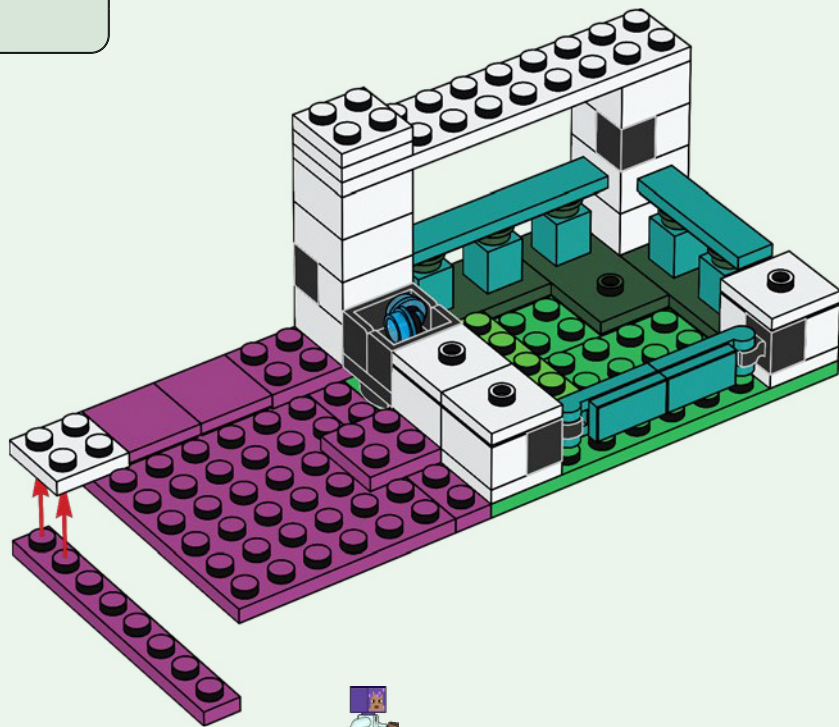

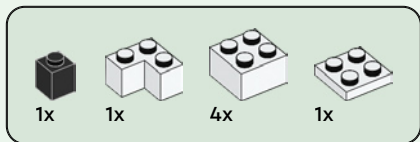

40

1

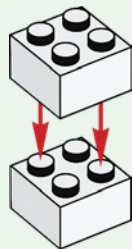

2

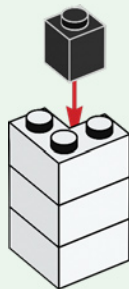

3

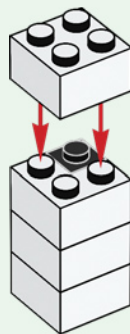

4

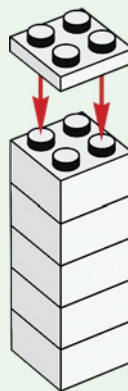

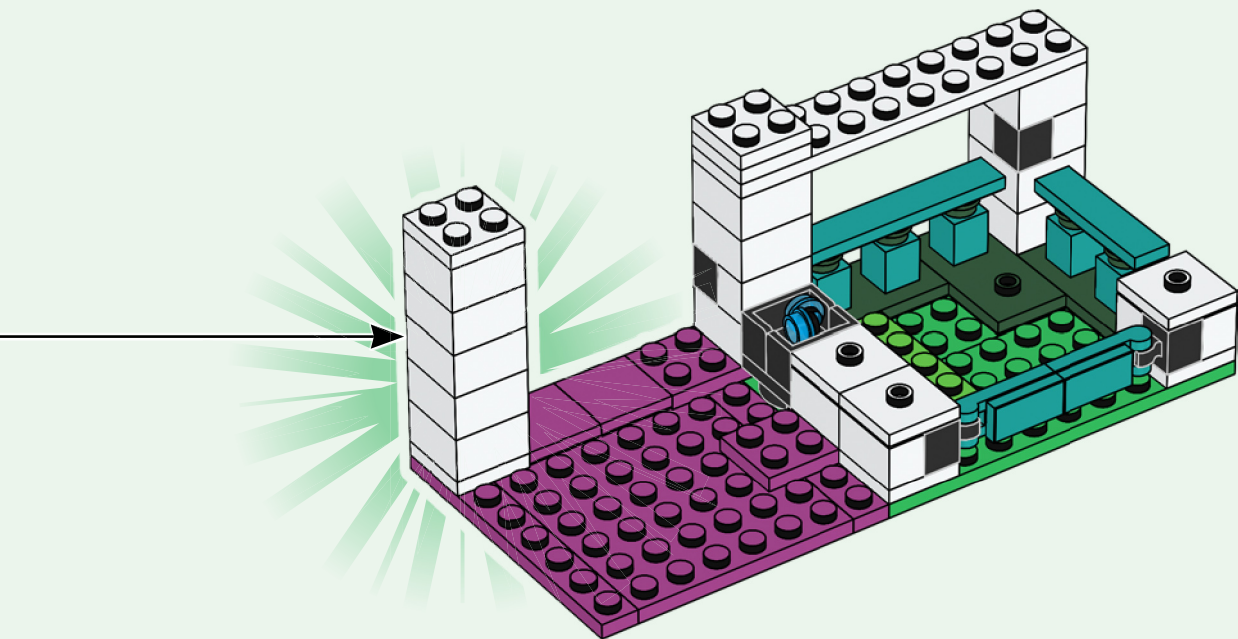

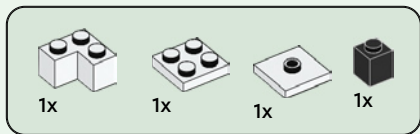

41

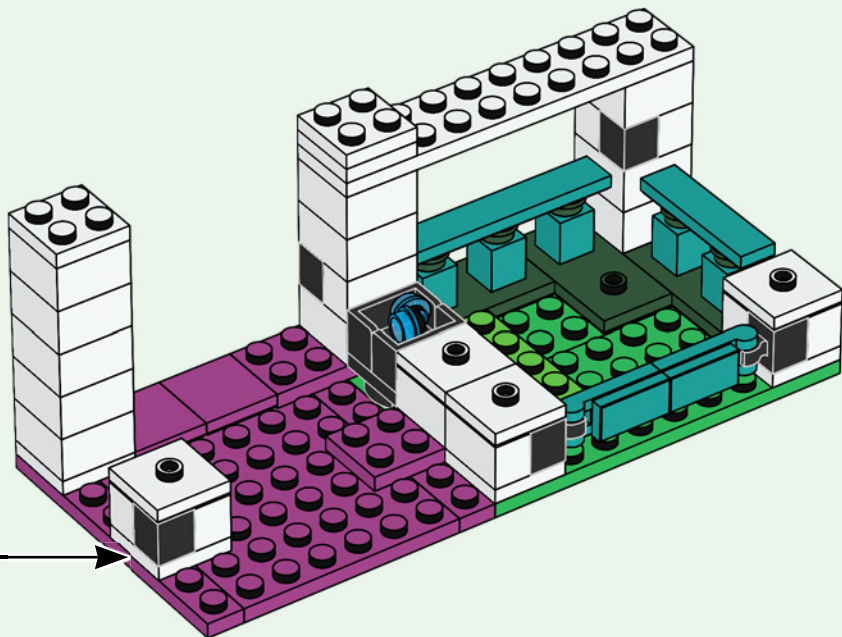
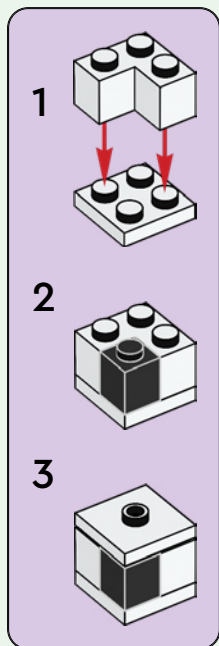

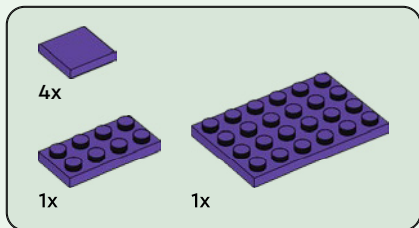

42

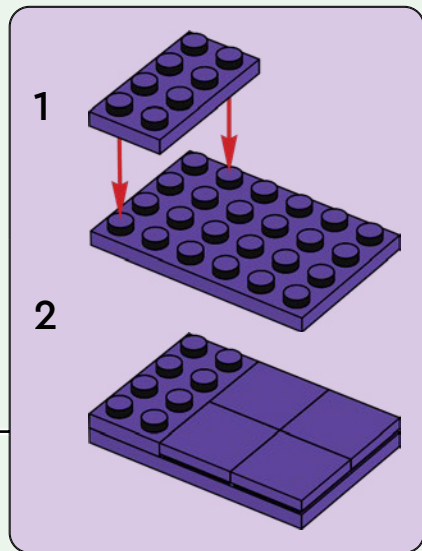
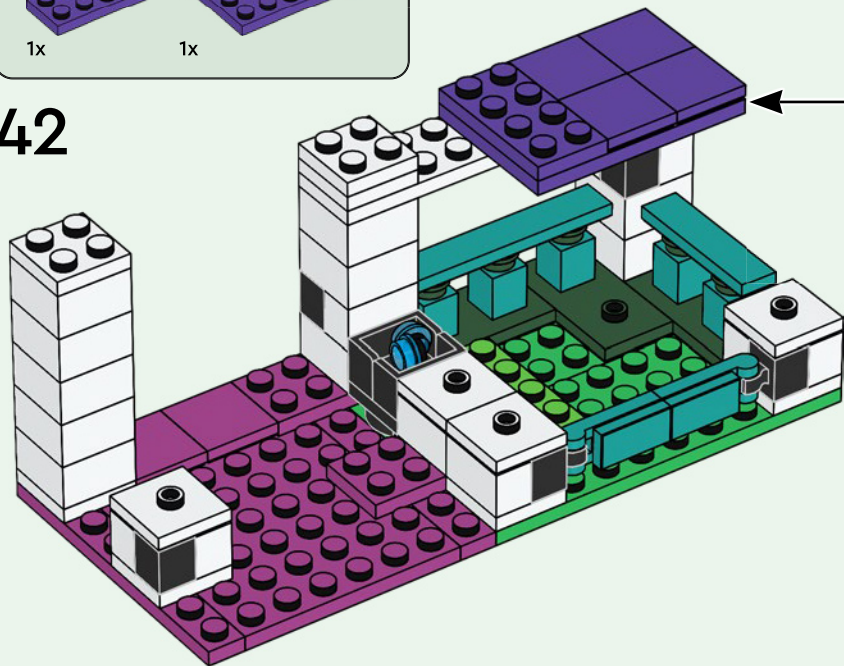

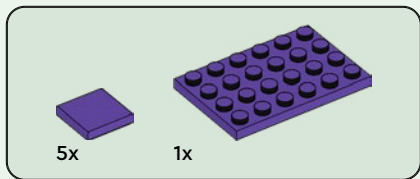

43

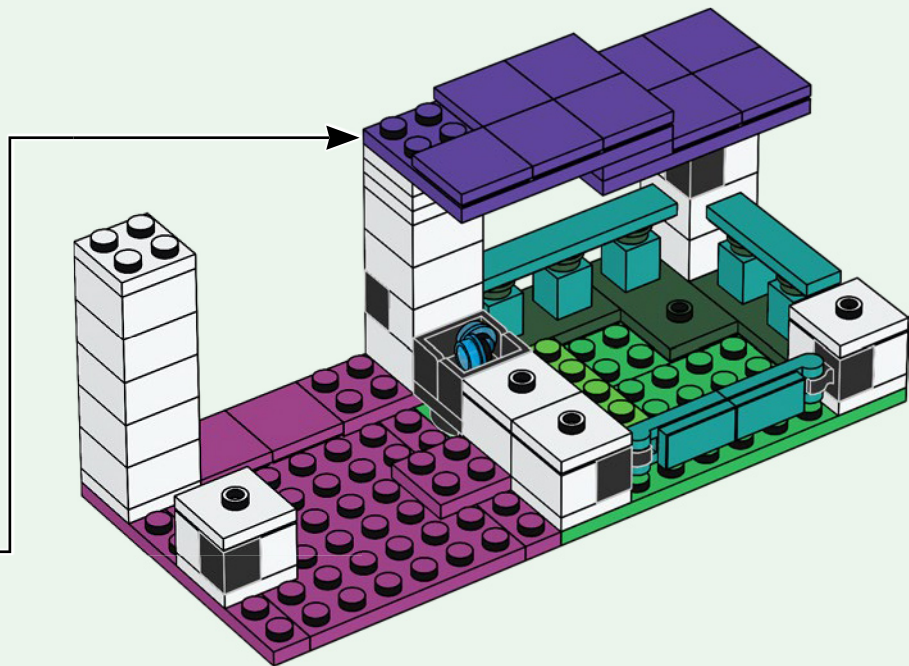
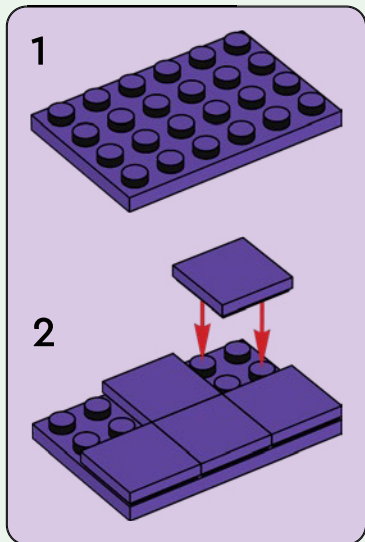

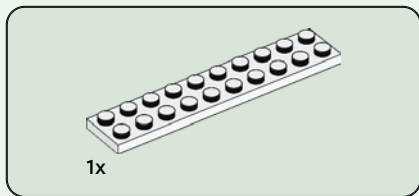

44

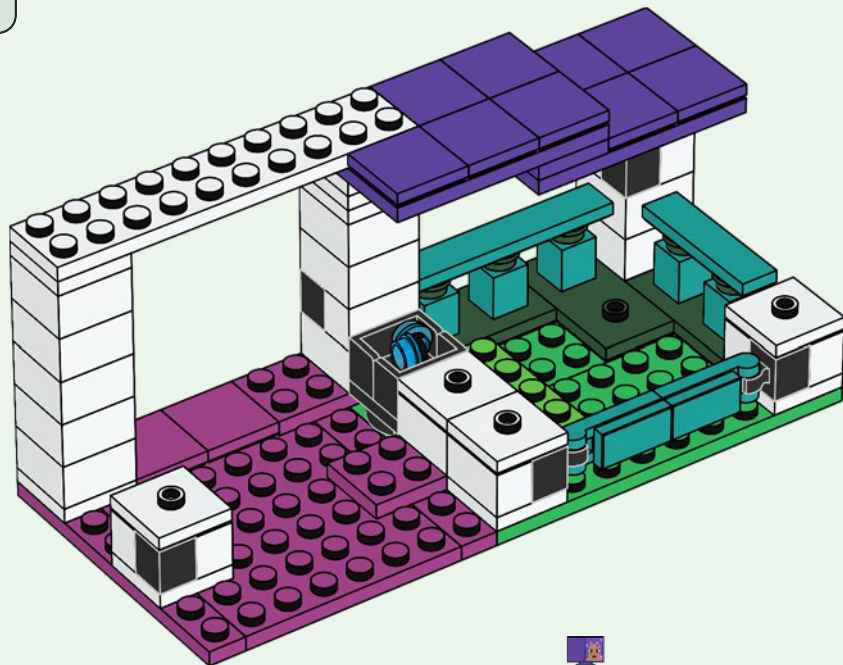



8x



2x

45

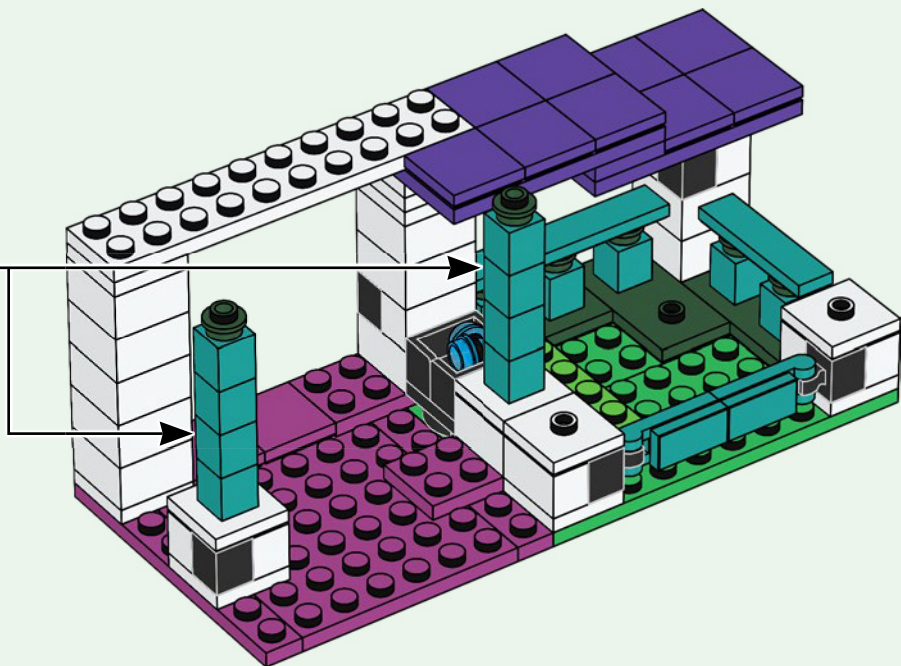
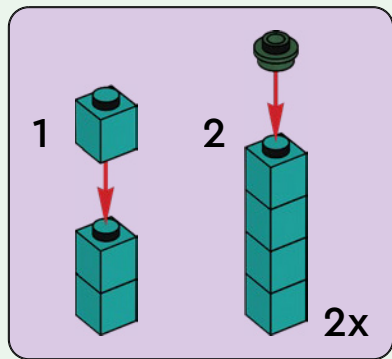

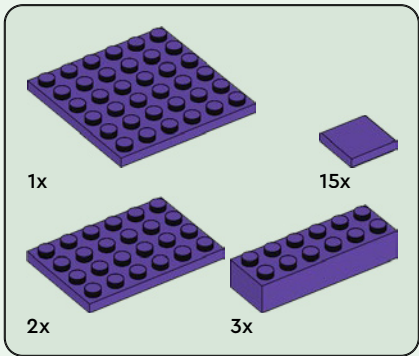

46

1

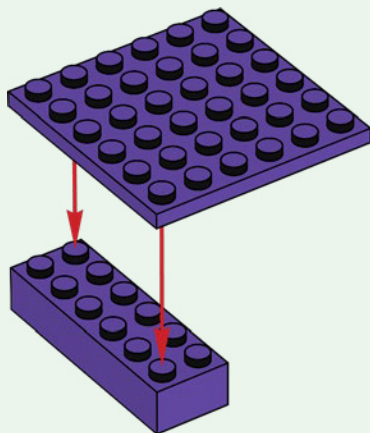

2

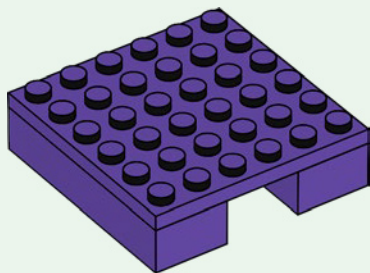

3

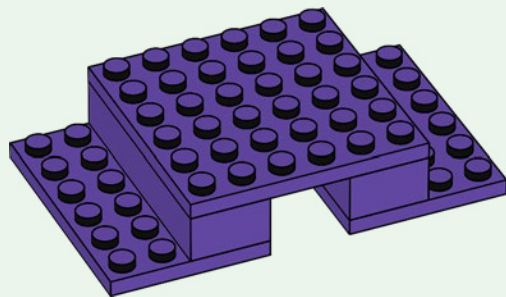

4

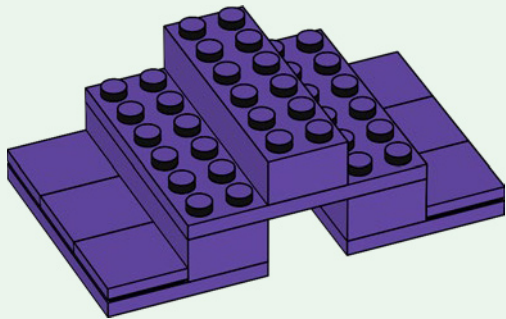

5

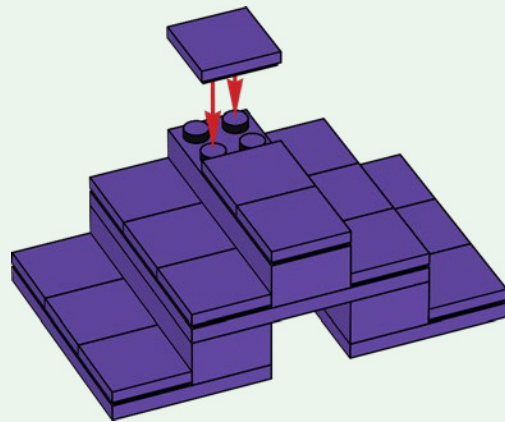

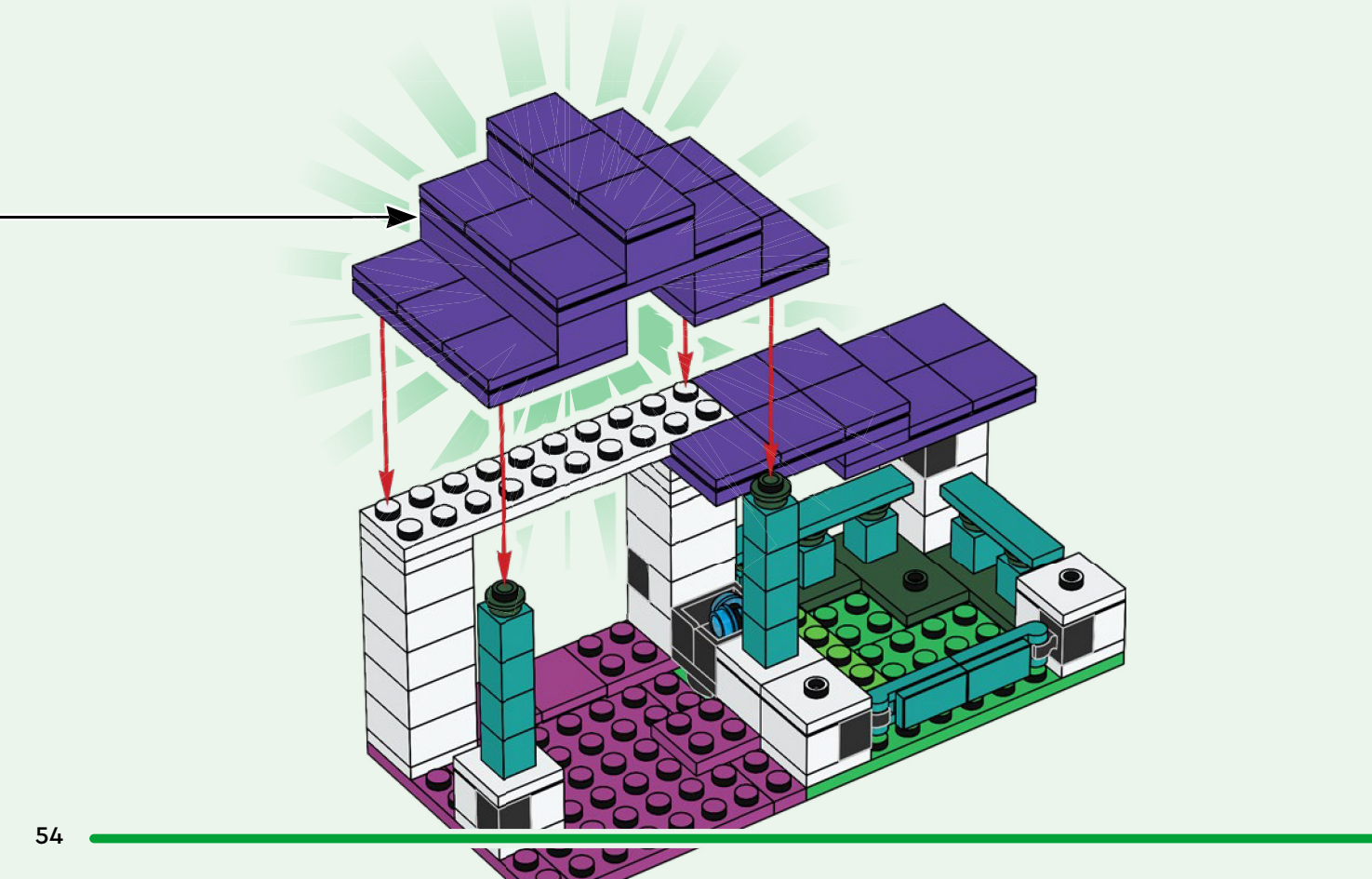

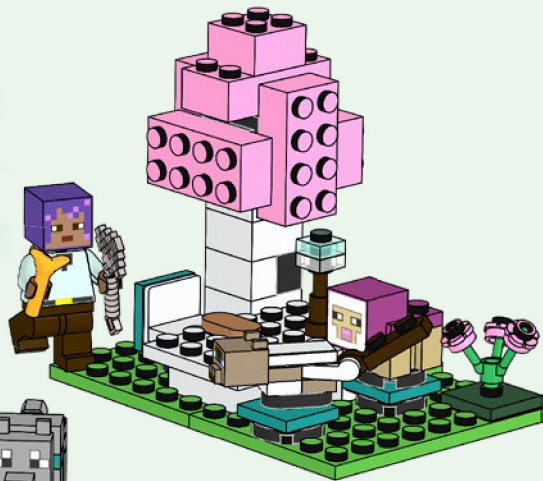
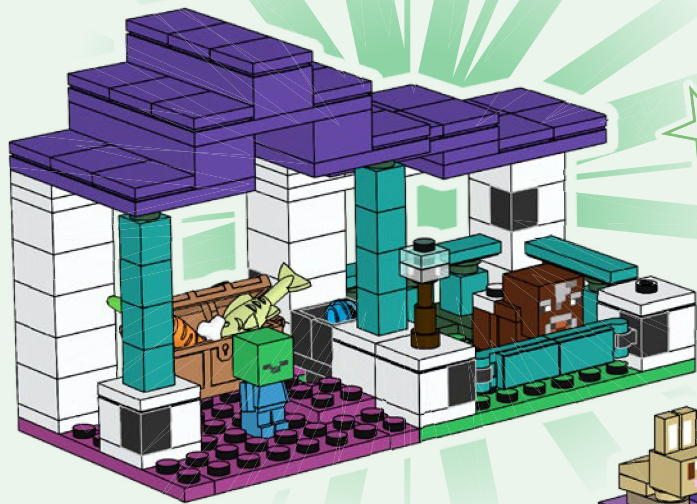



MINECRAFT

21256



21257



21251

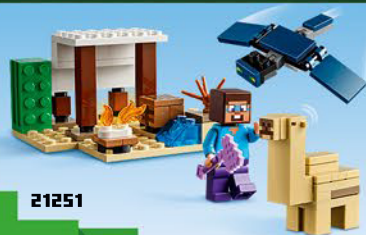

21255



21252



21253



21254



MINECRAFT



21252



21255

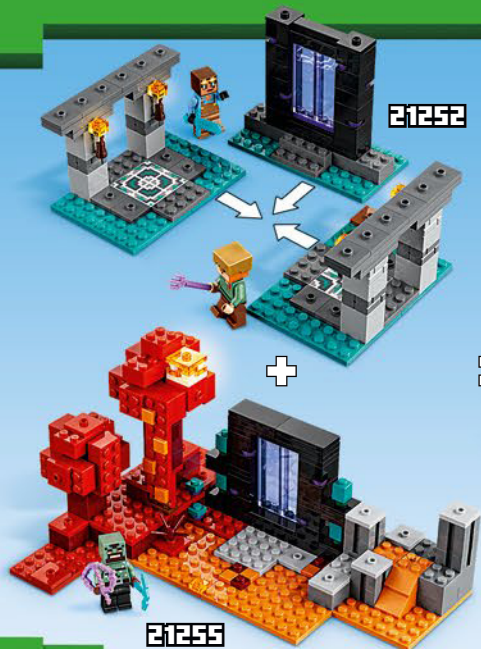

Combine sets to expand your play!

Kombiniere Sets für noch mehr Spielspaß!

Combine les niveaux pour étendre ton expérience de jeu !

Combina i set per espandere il tuo gioco!

¡Combina sets para jugar mucho más!

Combina sets para expandir os teus momentos de diversão!

組合系列套裝，增強玩樂體驗！

Łącz zestawy i baw się jeszcze lepiej!

Kombinujte stavebnice a rozšiřujte svou hru!
Kombinujte stavebnice a rozšiřujte herné možnosti!
A készletek egyesítésével bővítsd a játékot!

Combină seturi pentru a-ți extinde joaca!
Комбинируйте комплекты за по-интригуваща игра!
Arvieno kompleksus, lai pilnveidotu savas rotaļas!

Kombineeri komplekte, et mängu laiendada!
Derinkite rinkinius ir išplėskite žaidimą!

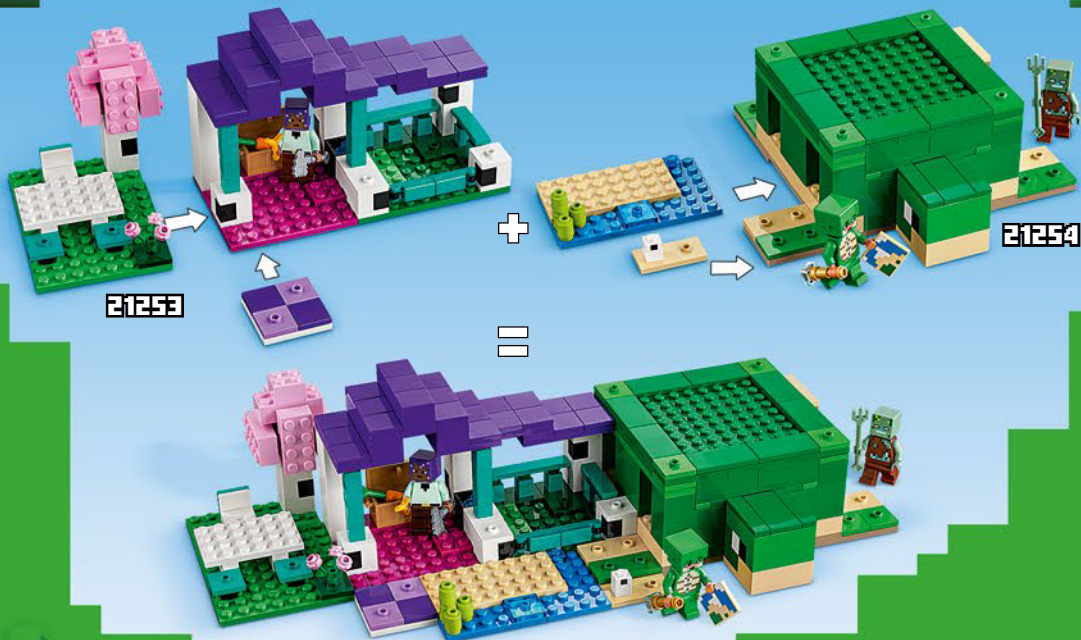



Rebuild
the
world™





Rebuild
the
world™





2x
302401



1x
6360202



1x
6174937



1x
302301



1x
306901



1x
6097637



1x
6218822



8x
302201



15x
300301



7x
235701

62



4x
6126046



2x
301001



1x
4243812



1x
303201



2x
383201



1x
4161734



1x
4159553



2x
6103001



1x
6468465



1x
6468465



5x
300526



2x
6336977



1x
6210270



7x
403226



2x
6248496



4x
6117973



1x
302226



1x
302226



1x
302226



1x
302226



1x
6331398



1x
6269971



1x
4119479



2x
6141590



2x
6340684



2x
6398657



1x
6264986



1x
6264986



1x
6264986



1x
6264986



13x
6213776



1x
6213777



2x
6213779



3x
6290269



2x
6295286



1x
6292786



1x
6264986



1x
6264986



1x
6264986



1x
6264986



1x
6424015



1x
6103415



2x
6249234



1x
6468464



2x
6037658



2x
6109929



2x
6109929



2x
6109929



1x
6441042



1x
6441042



1x
4549436



1x
6231386



1x
6468466



7x
6230571



1x
6186827



3x
6383324



1x
4221744



2x
6103004



1x
6468468



1x
6343976



2x
4617170



1x
6313114



1x
4211414



1x
6468467



3x
6212501



1x
4550359



5x
4520632



26x
6057386



1x
6468469



1x
6030277



3x
6147004



4x
6147032



1x
6426669



2x
6252043



2x
6252041



2x
6240214



1x
6291414



1x
4529672



2x
4538950



1x
6347286



1x
6096682



1x
6399909



1x
6394960



1x
6102984



1x
6089099



1x
6397838



1x
6470358



2x
6177195



 [LEGO.com/service](https://www.LEGO.com/service)

YOU COULD
WIN



Scan this QR code or go to
LEGO.COM/PRODUCTFEEDBACK and give
us your short feedback about this LEGO® set
for a chance to win a cool LEGO prize.

Terms and Conditions apply*

EN: YOU COULD WIN. Terms and Conditions apply* **DE: Du könntest GEWINNEN.** Es gelten die Teilnahmebedingungen* **FR: Tu pourrais GAGNER.** Des conditions s'appliquent* **IT: Potresti VINCERE tu.** Termini e condizioni sono applicabili* **ES: Puedes GANAR.** Aplican términos y condiciones* **PT: Poderá GANHAR.** Aplicam-se termos e condições* **ZH: 轻松获奖. 条款和条件适用*** **PL: Szansa na WYGRANĄ.** Obowiązują warunki korzystania* **CS: Máte šanci VYHRÁT.** Platí všeobecné smluvní podmínky* **SK: Máte šancu VYHRAŤ.** Platia všeobecné zmluvné podmienky* **HU: TE IS NYERHETSZ.** Felhasználási feltételek érvényesek* **RO: Ai putea CÂȘTIGA.** Se aplică termenii și condiții* **BG: Можете да СПЕЧЕЛИТЕ.** Има определени правила и условия* **LV: Tu vari LAIMĒT.** Ir spēkā noteikumi un nosacījumi.* **ET: Sul on võimalus VÕITA.** Kehtivad tingimused* **LT: Jūs galite LAIMĖTI.** Taikomos sąlygos*

*[LEGO.com/productfeedback-terms](https://www.lego.com/productfeedback-terms)

LEGO and the LEGO logo are trademarks of the LEGO Group. ©2024 The LEGO Group.

© 2024 Mojang AB. All Rights Reserved. Minecraft, the Minecraft logo, the Mojang Studios logo and the Creeper logo are trademarks of the Microsoft group of companies.

6495800