



duplo

EXTRA
IDEAS
INCLUDED

D'AUTRES
IDÉES
INCLUSES

INCLUYE
IDEAS
EXTRA



10929
LEGO.com/DUPLO



duplo



Page 4

Page 36



CHOOSE
YOUR
FAVORITE

CHOISISSEZ
VOTRE
PRÉFÉRÉ

ELIGE
TU
FAVORITO



Page 61
Página



1x



1x

1x



1x

1x

1x



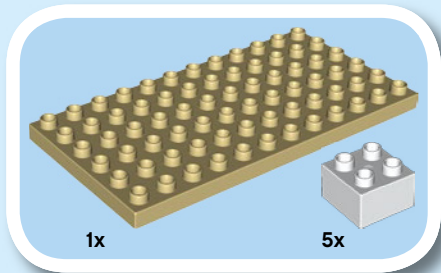

1

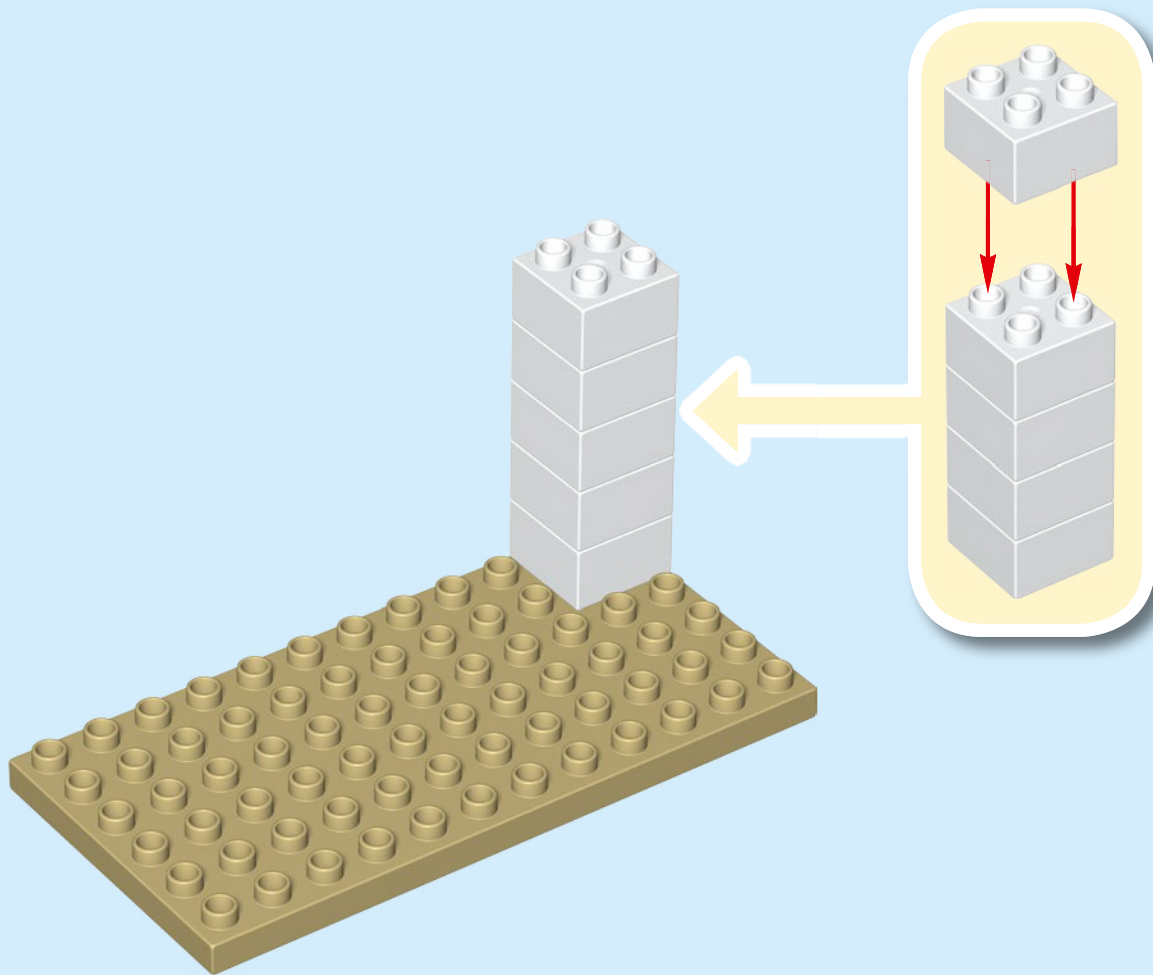

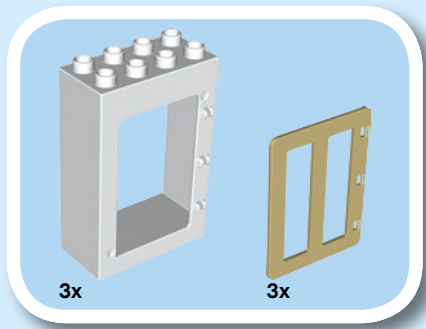

2

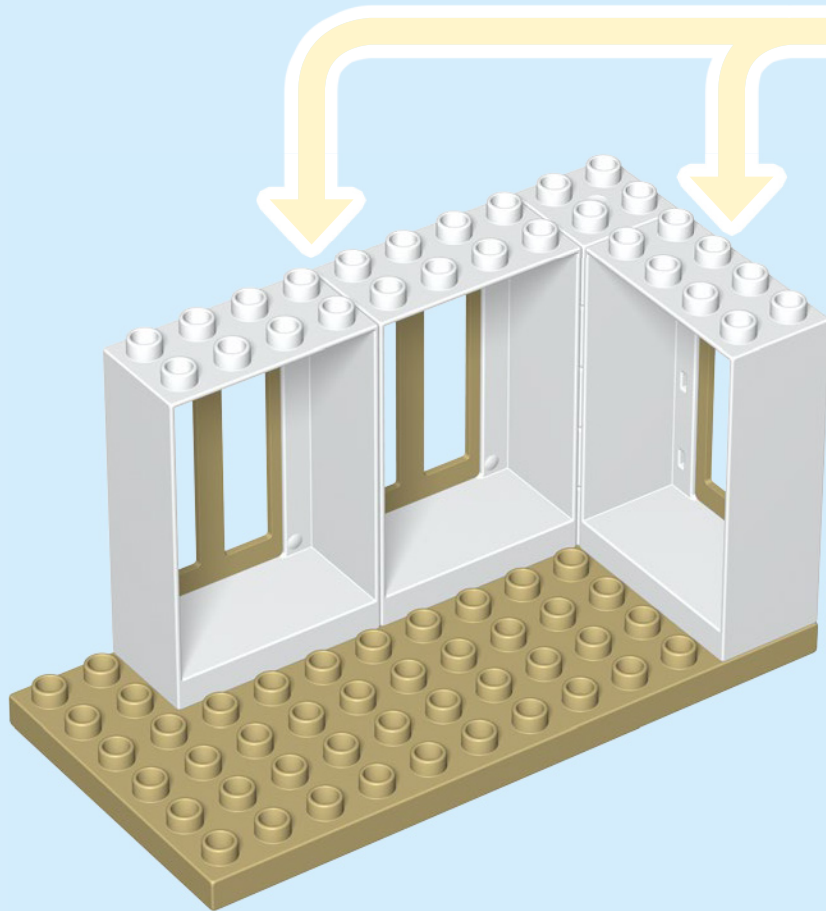
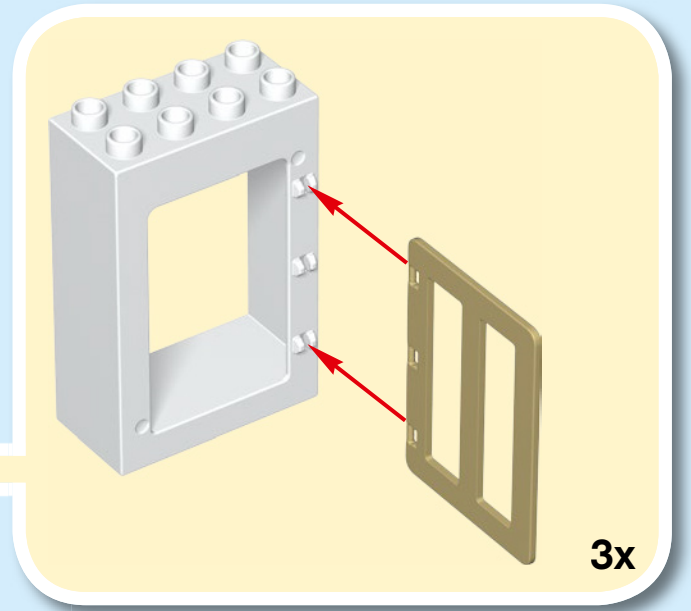

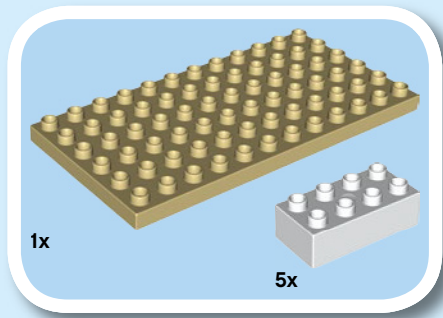

3

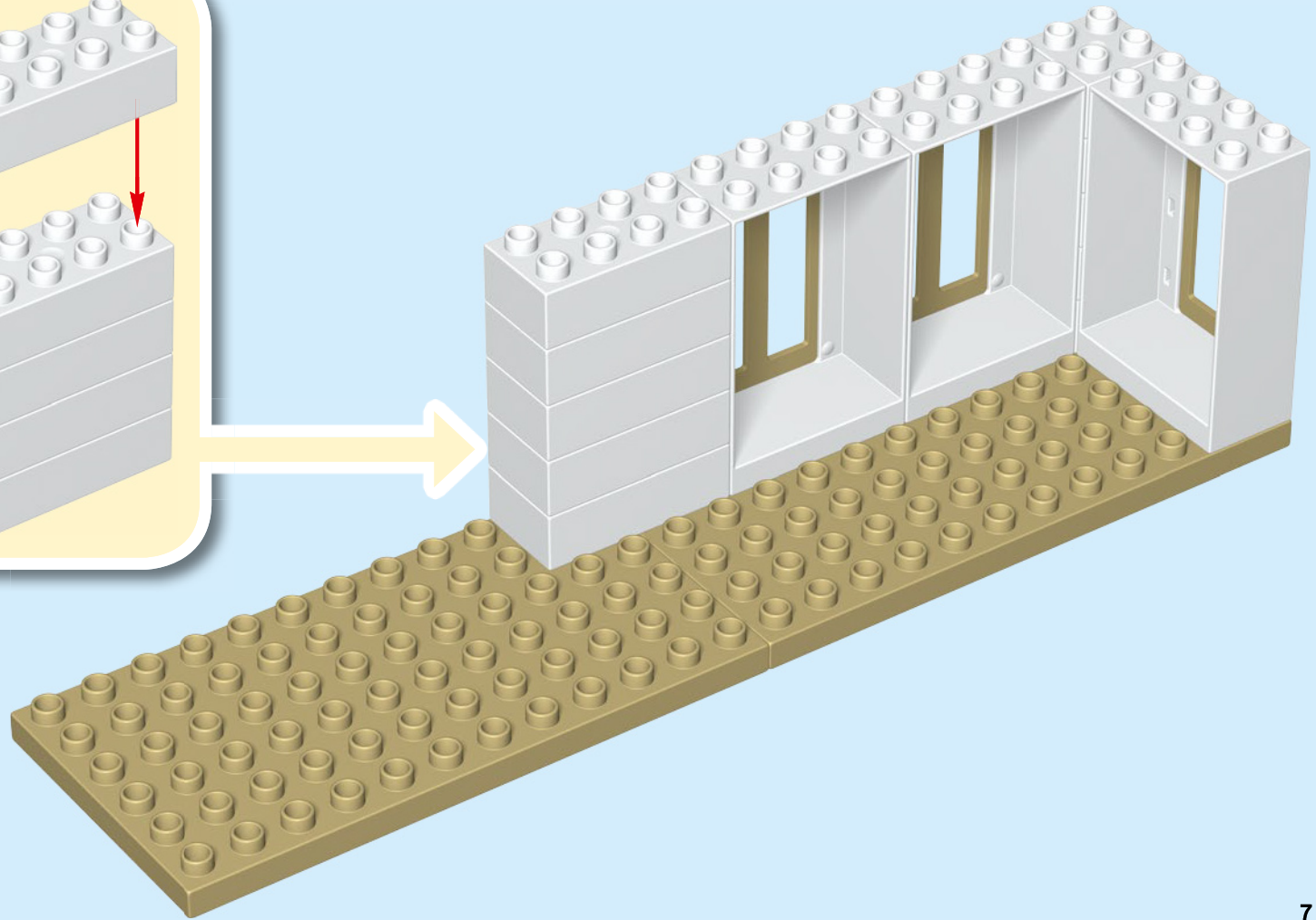
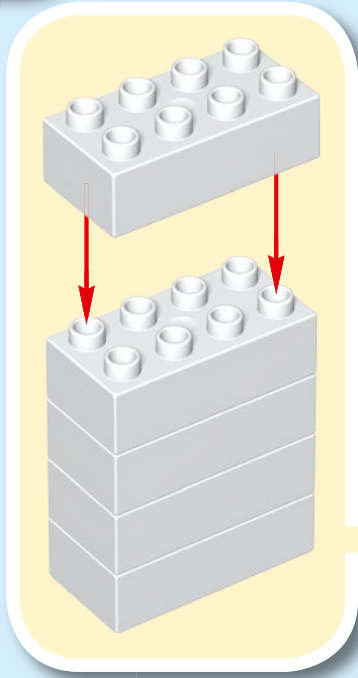

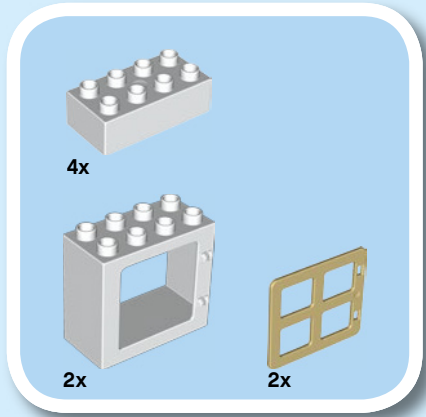

4

1

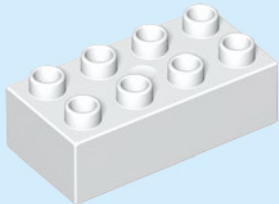

2

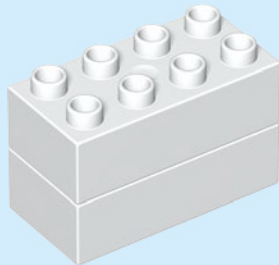

3

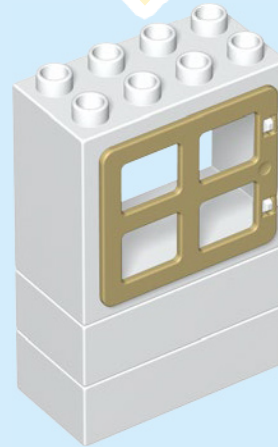

2x

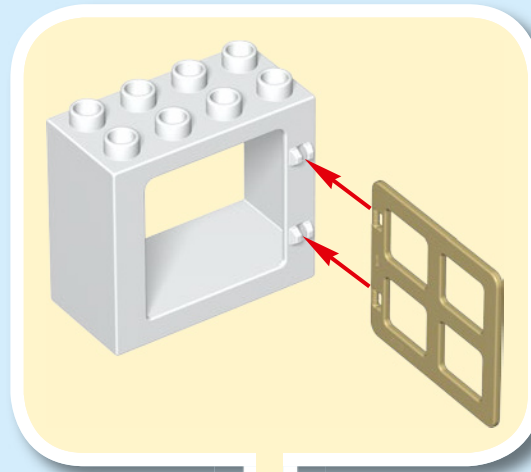

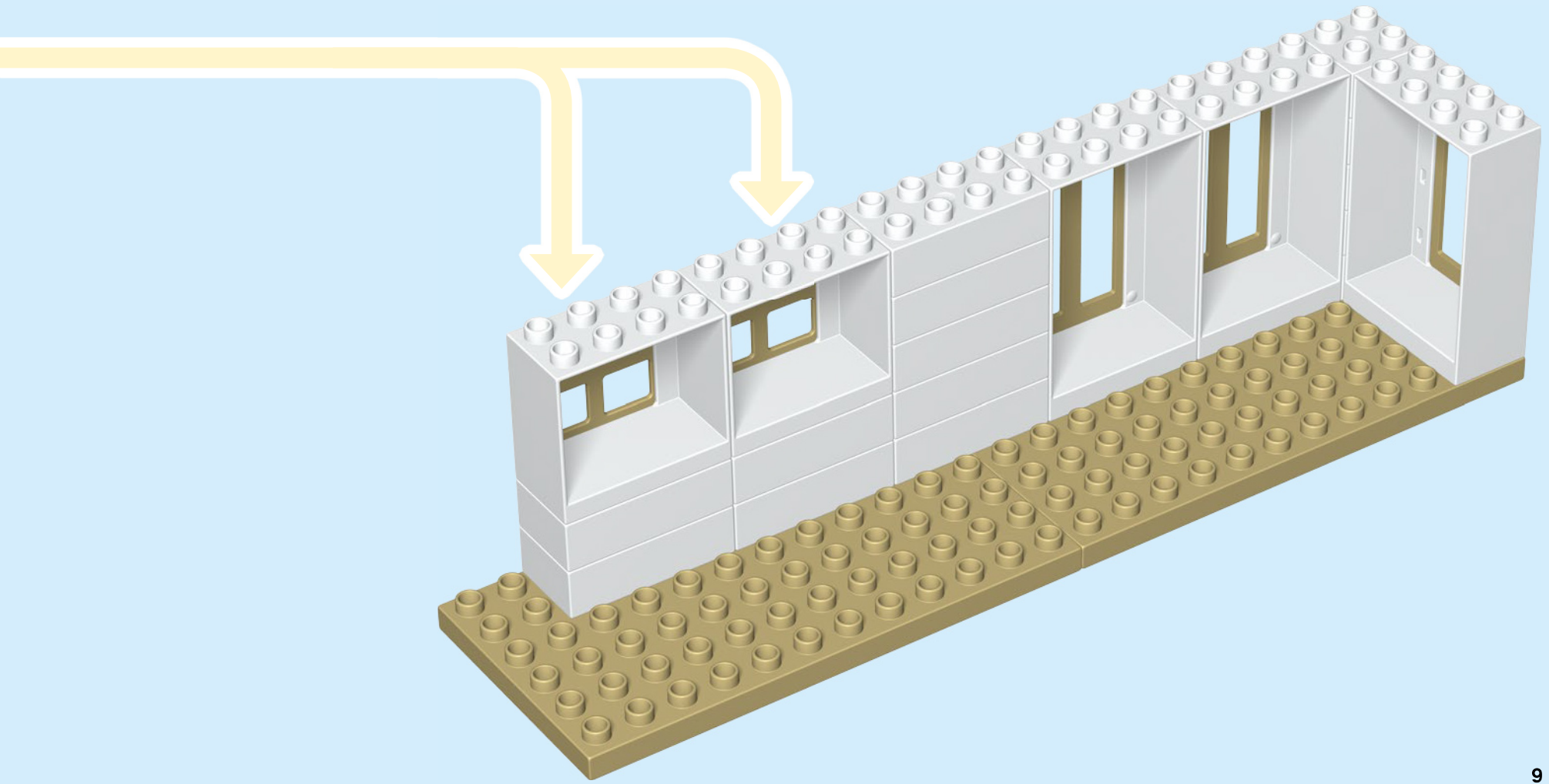

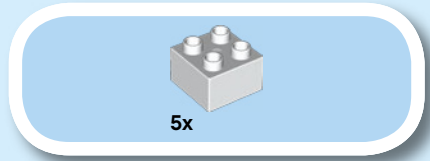

5

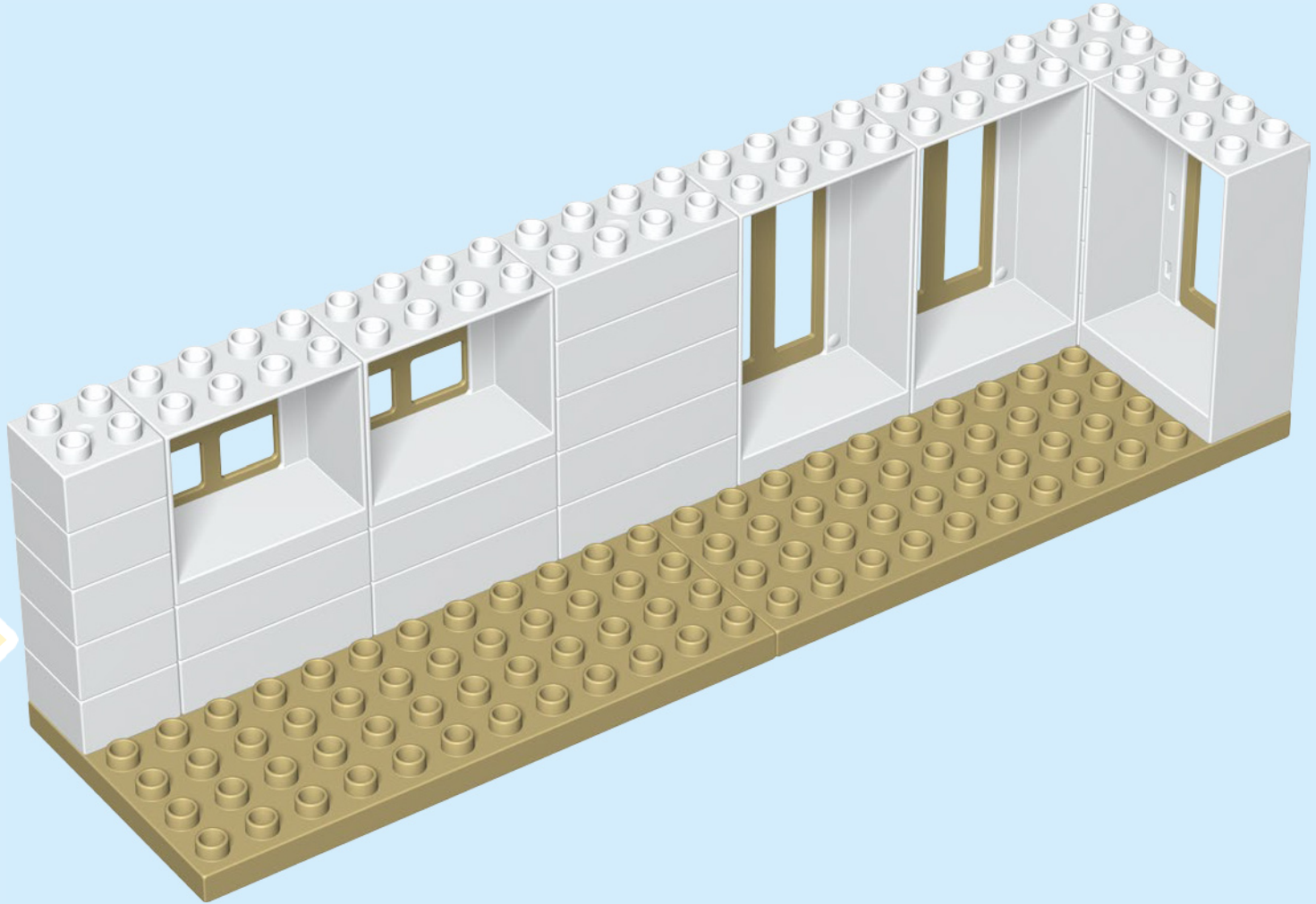
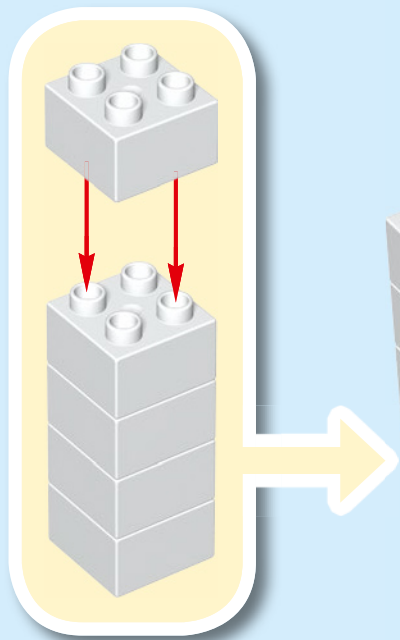

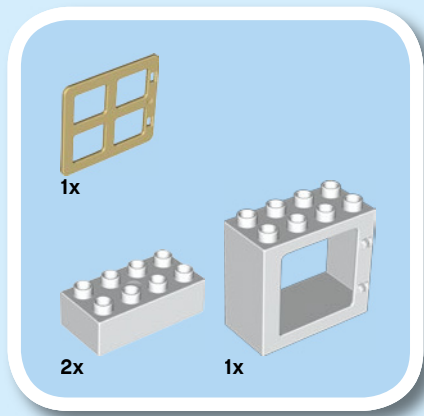

6

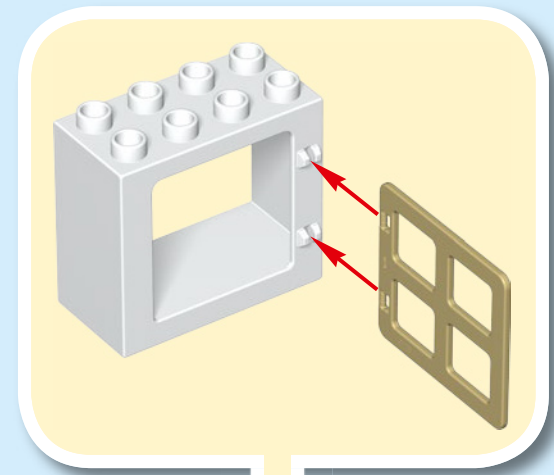

1

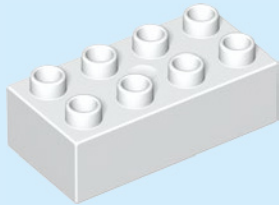

2

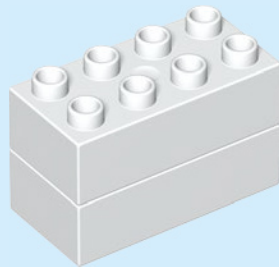

3

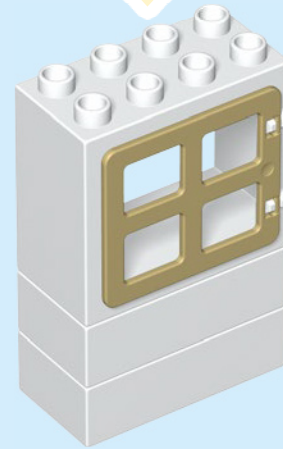

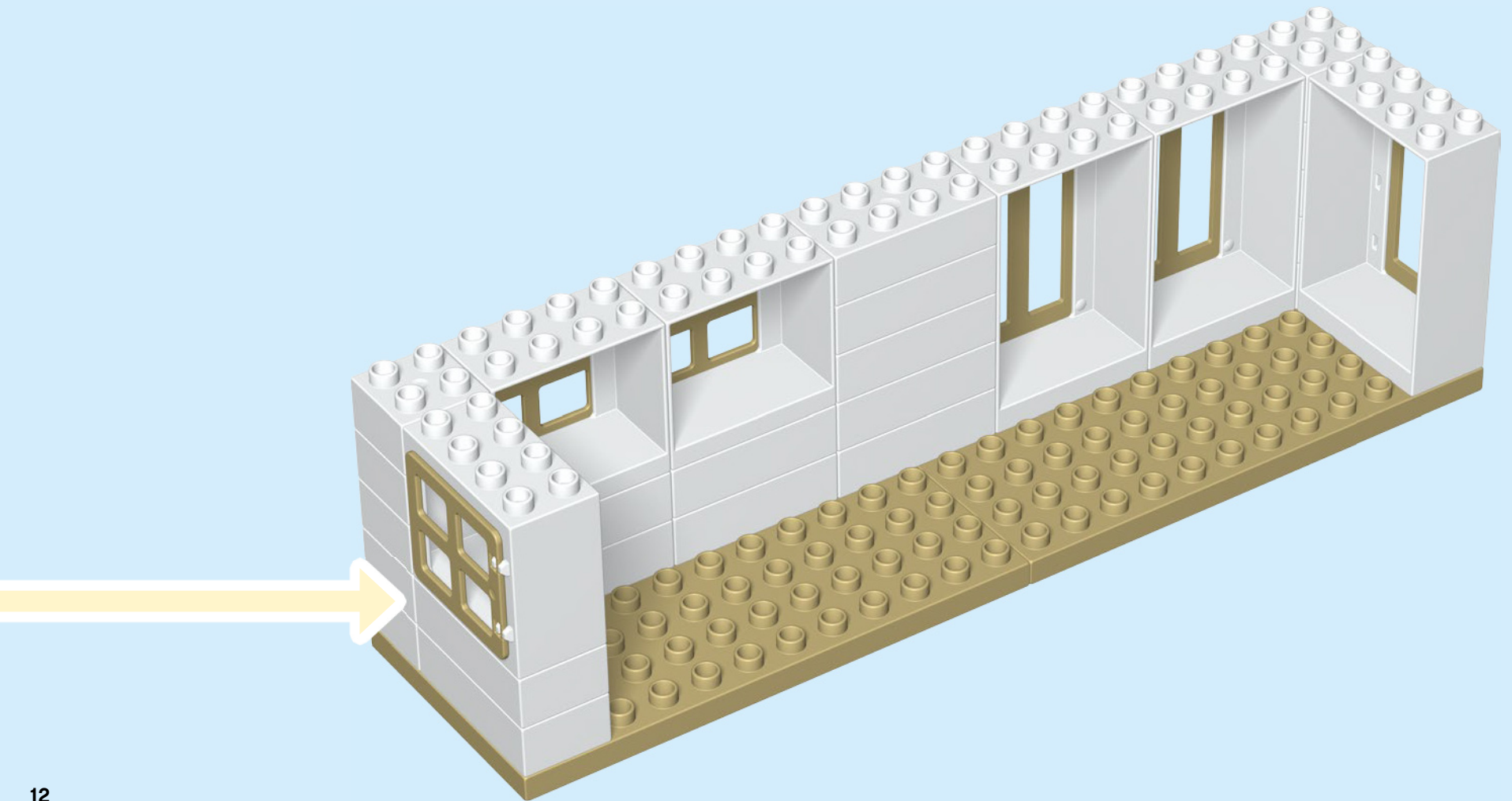

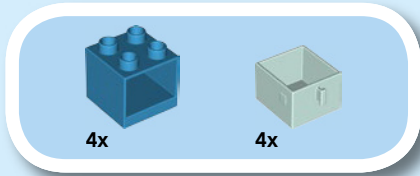

7

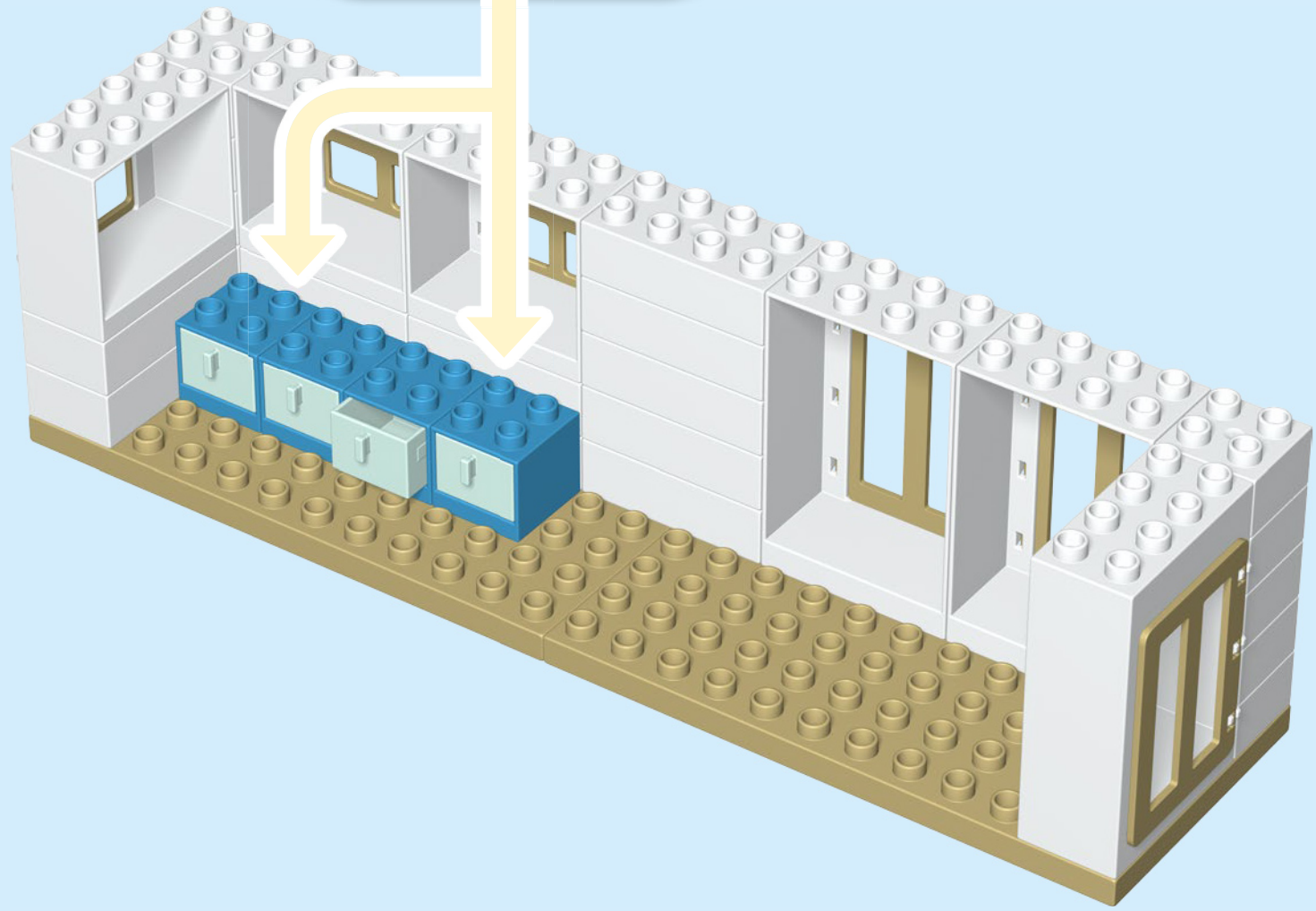
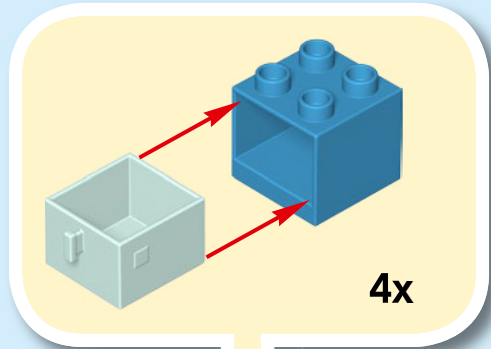

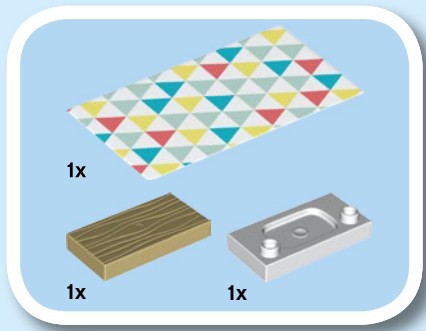

8

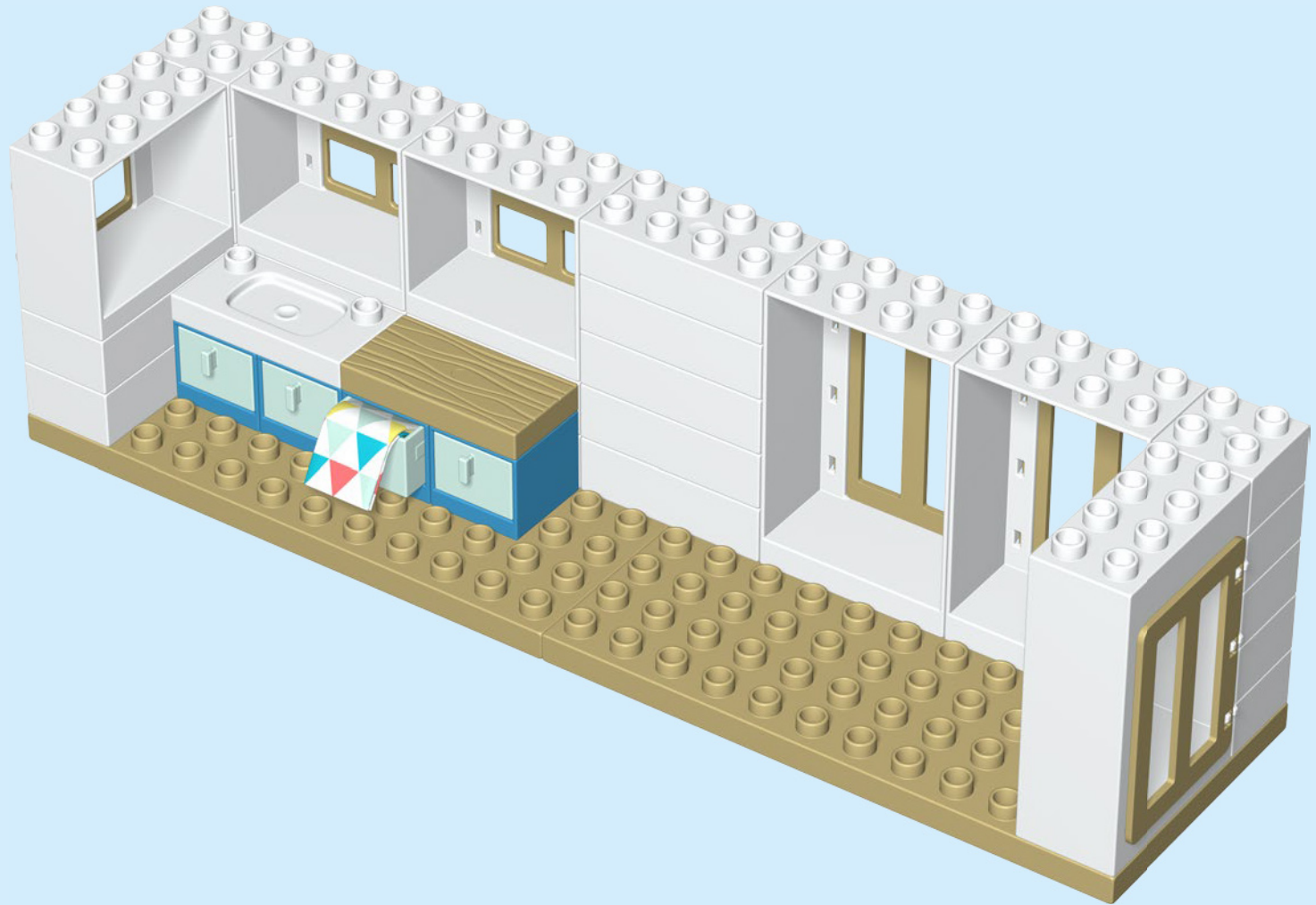

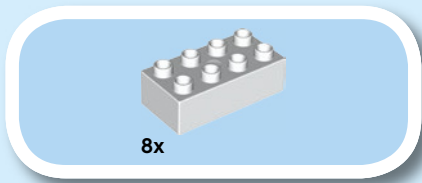

9

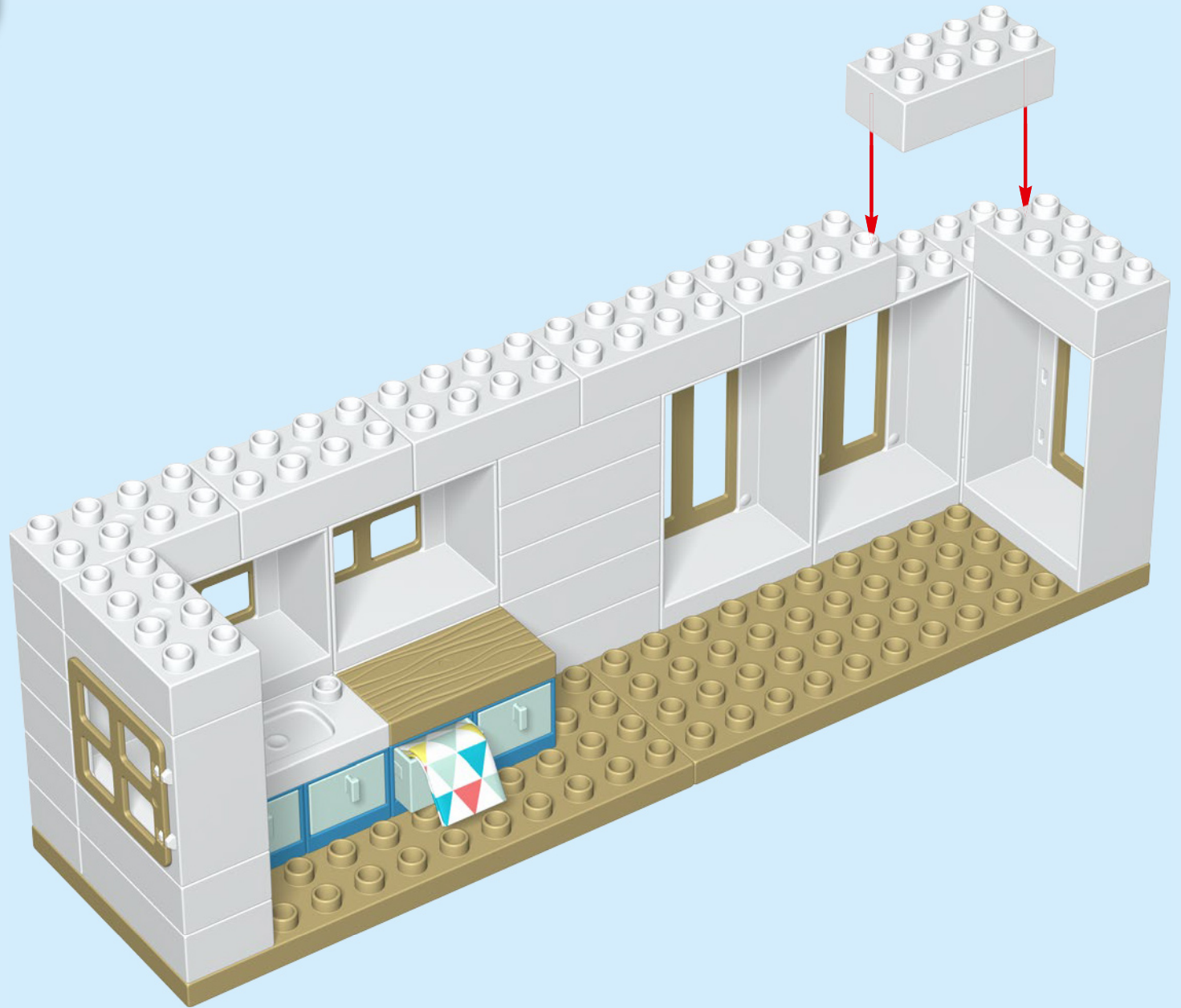

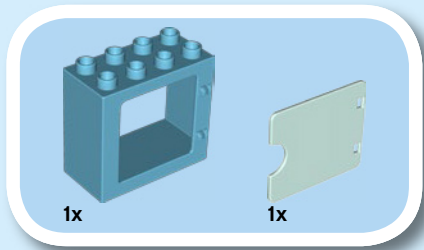

10

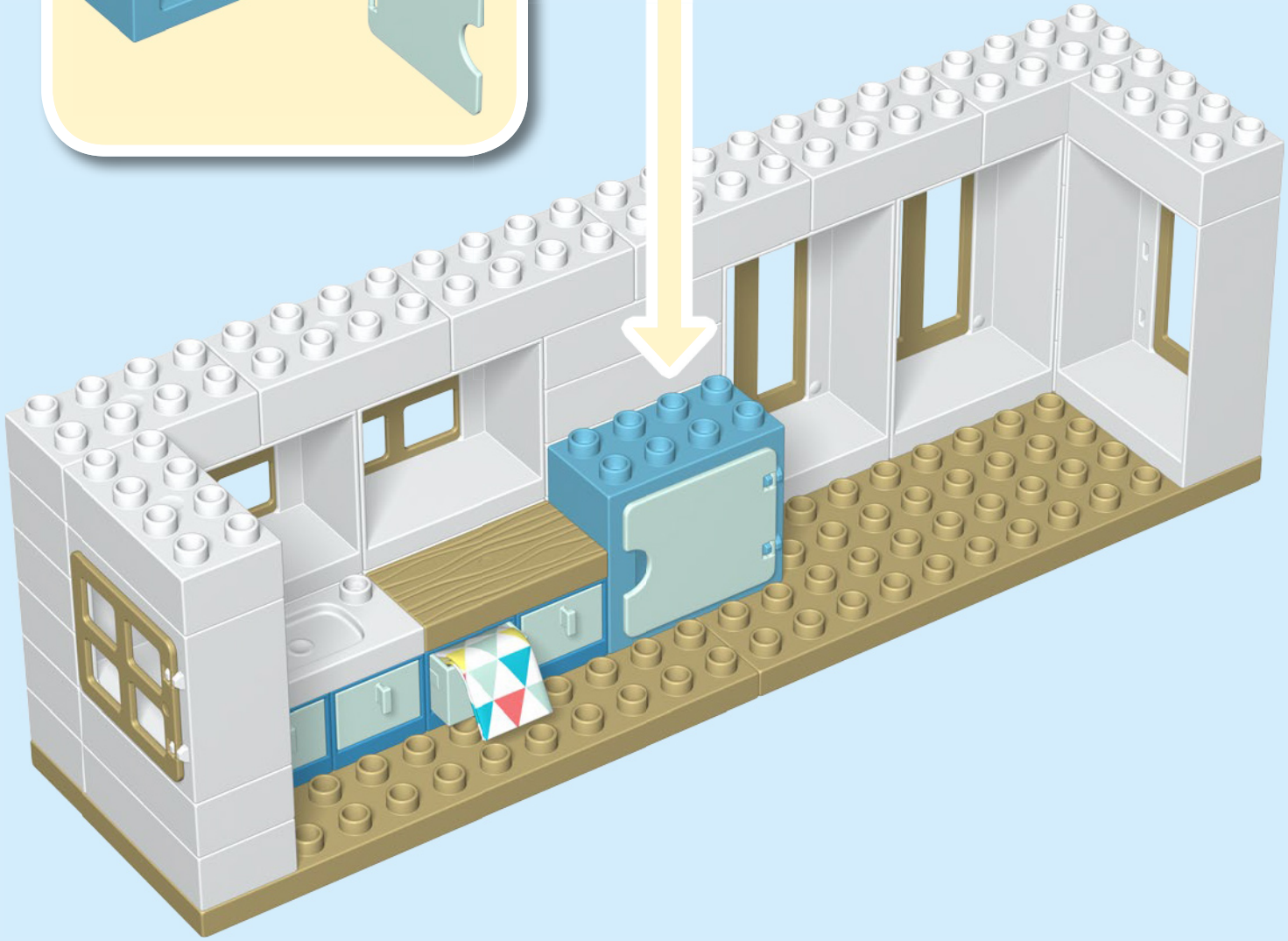
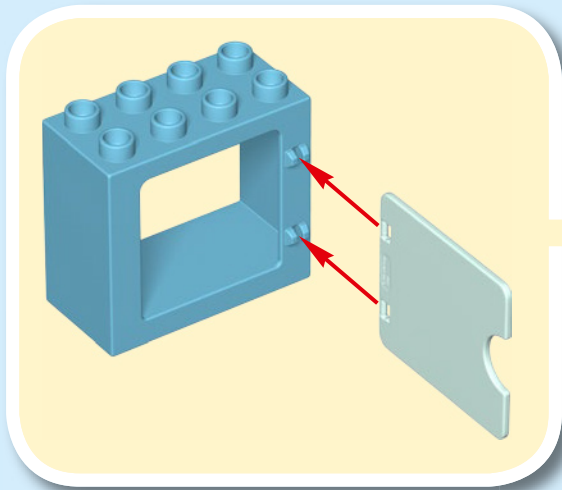

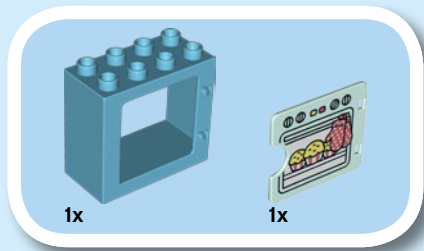

11

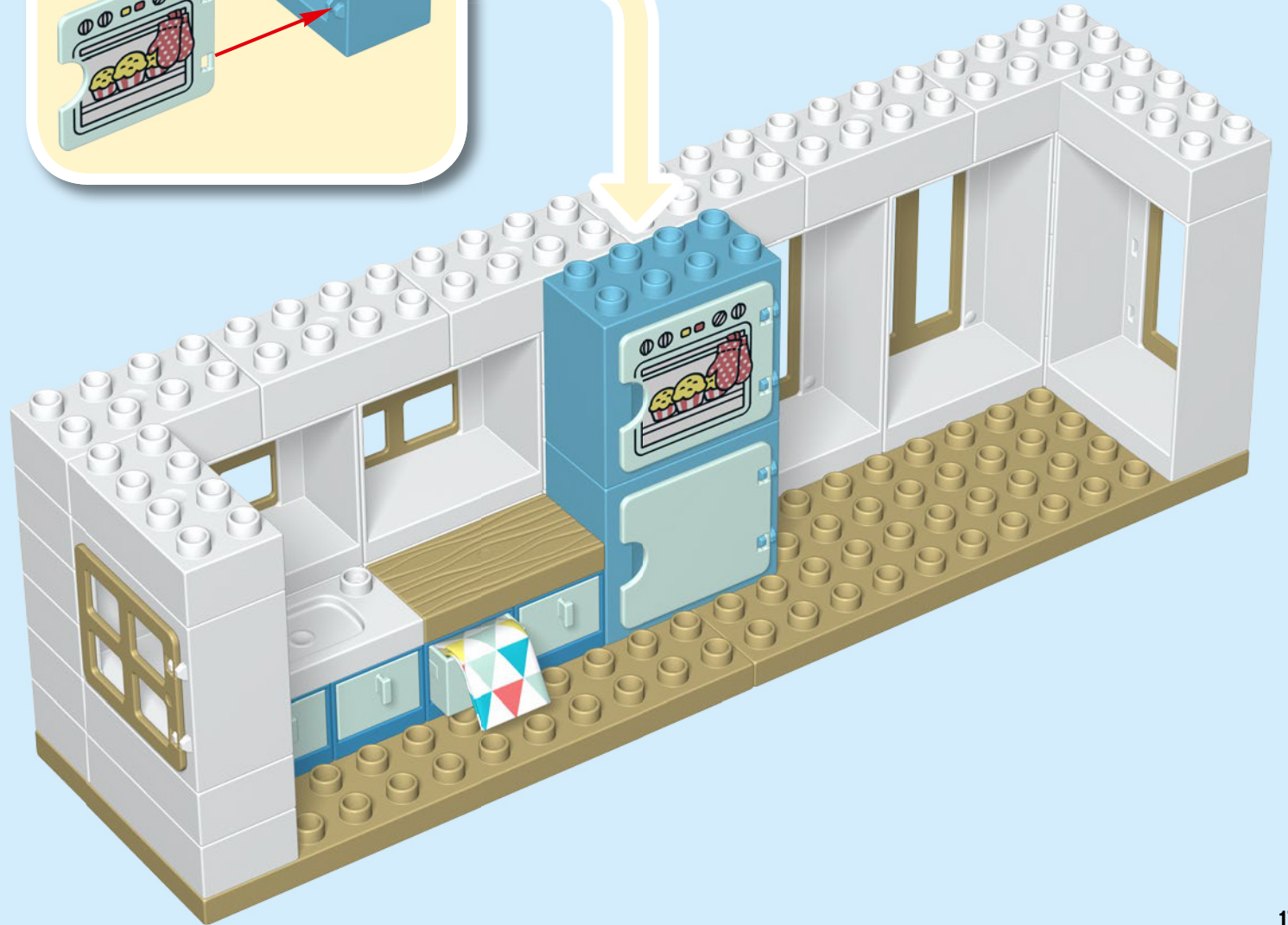
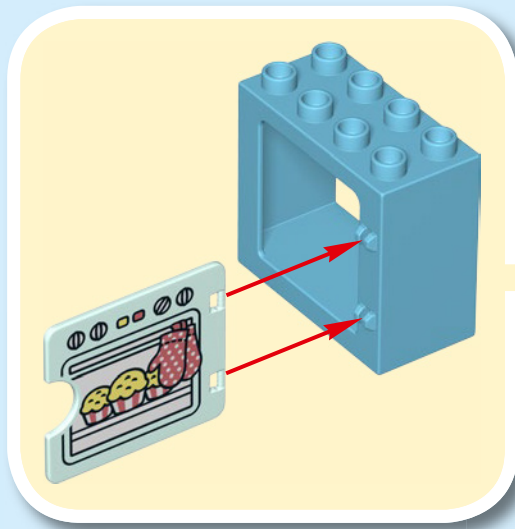

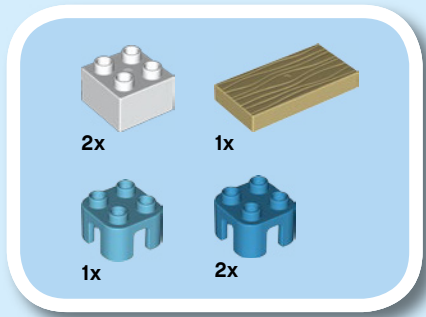

12

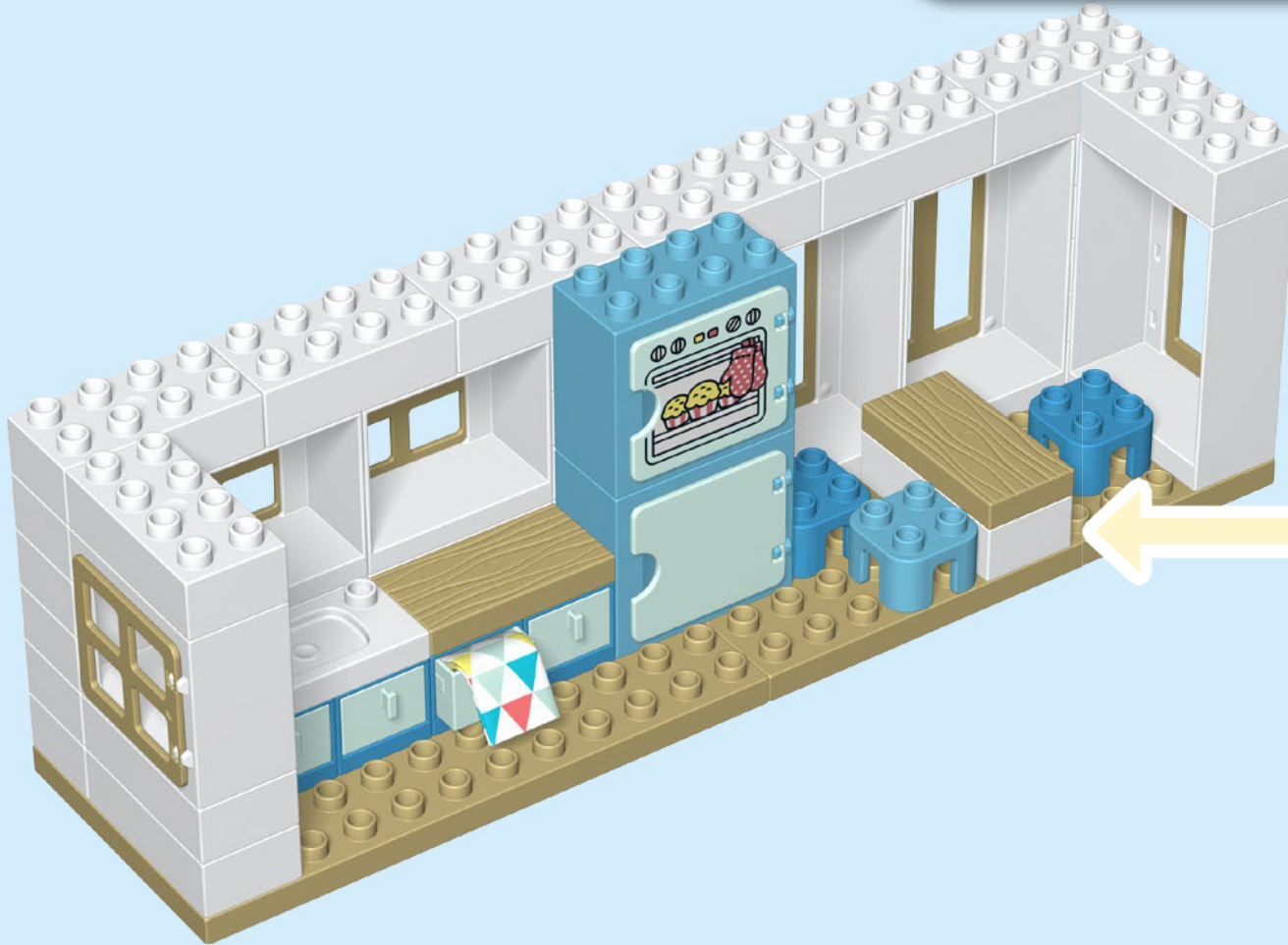
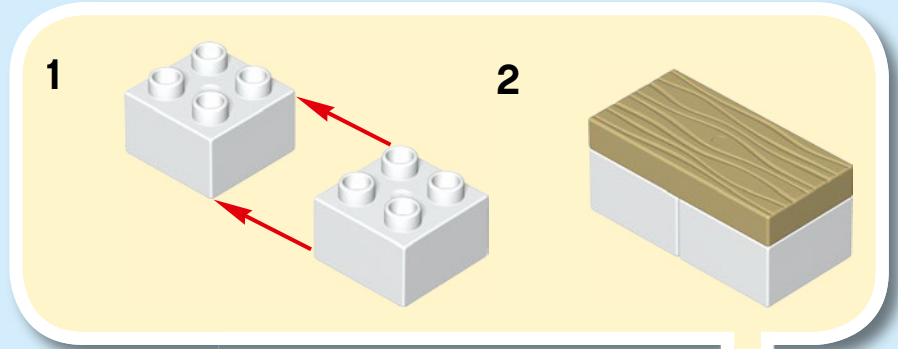

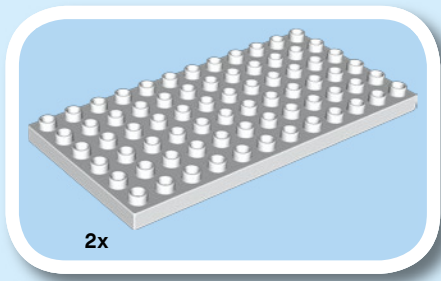

13

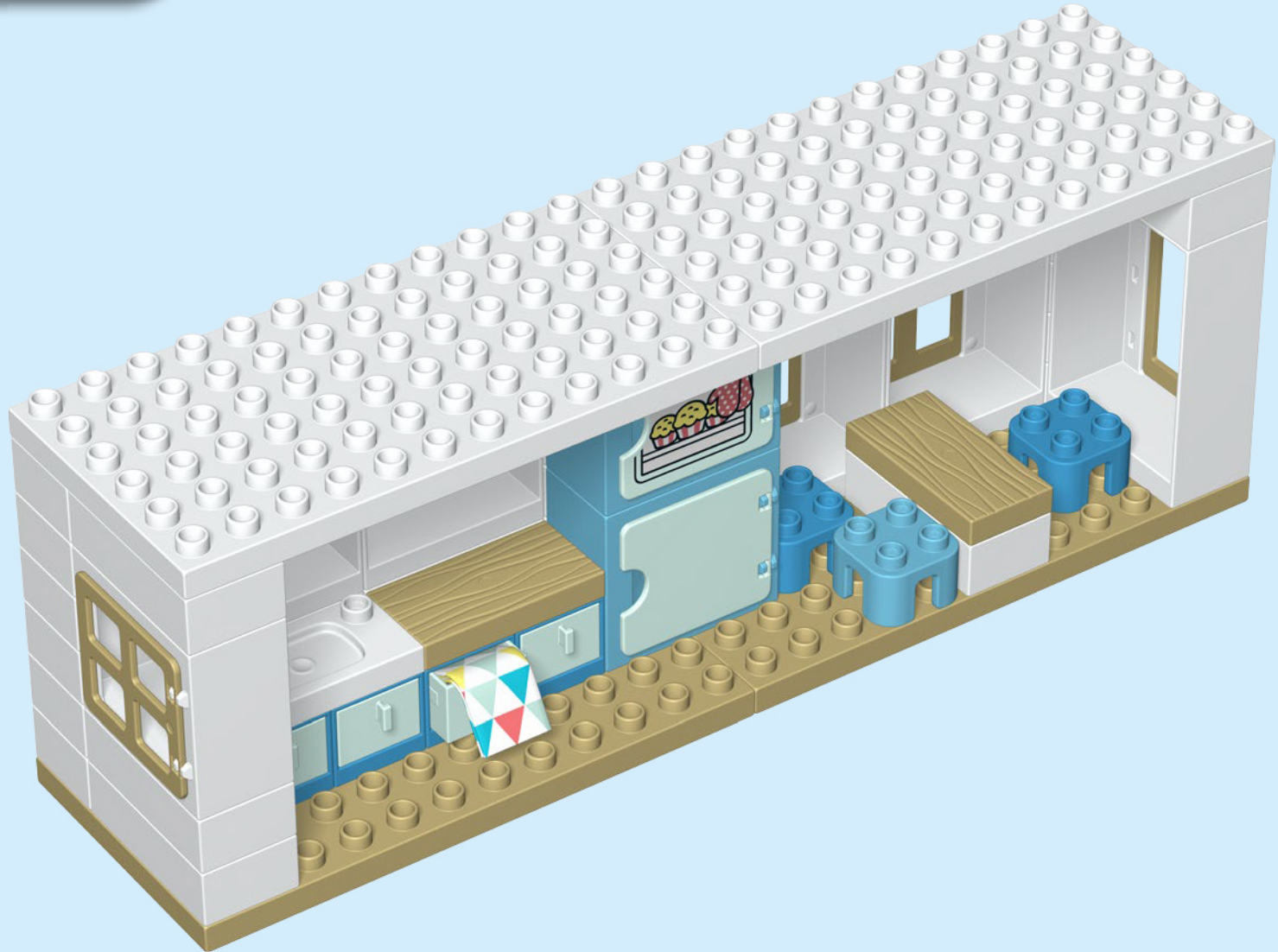

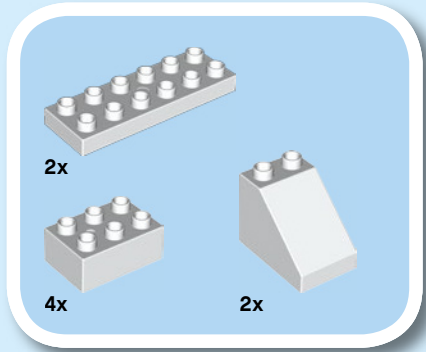
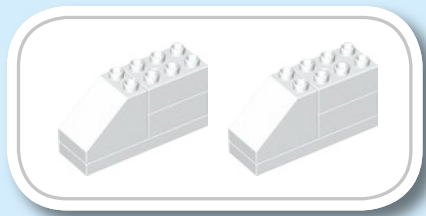

14

1

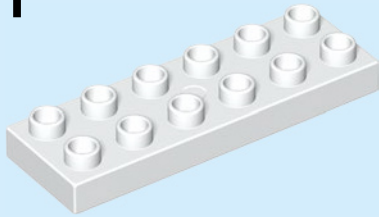

2

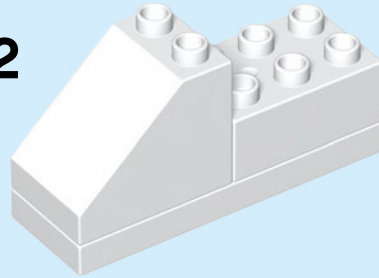

3

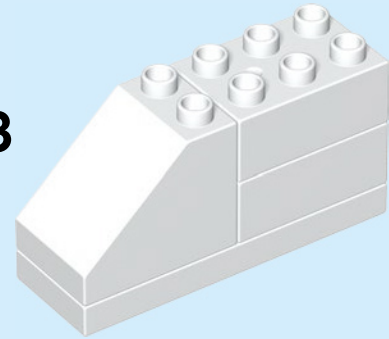

2x

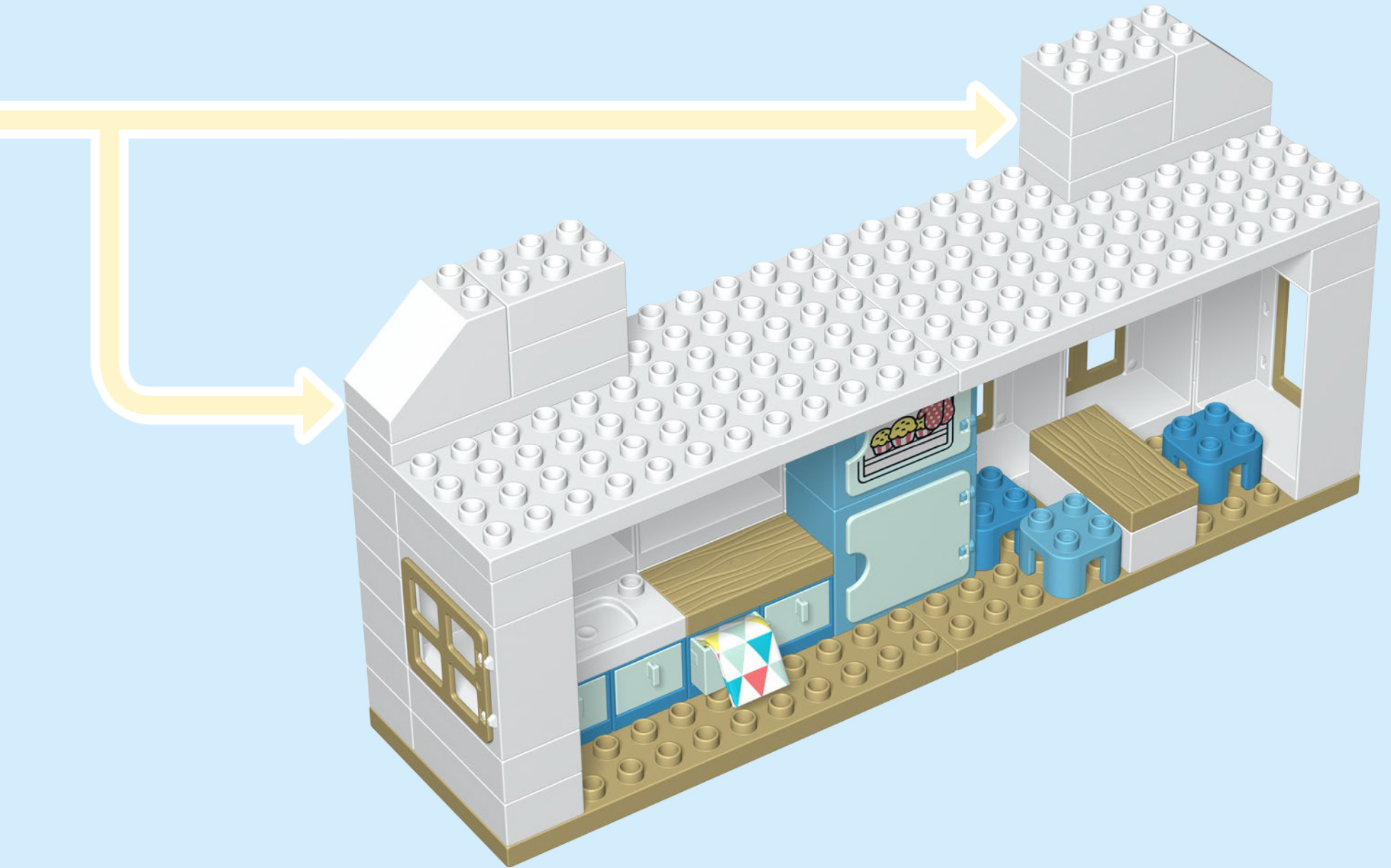

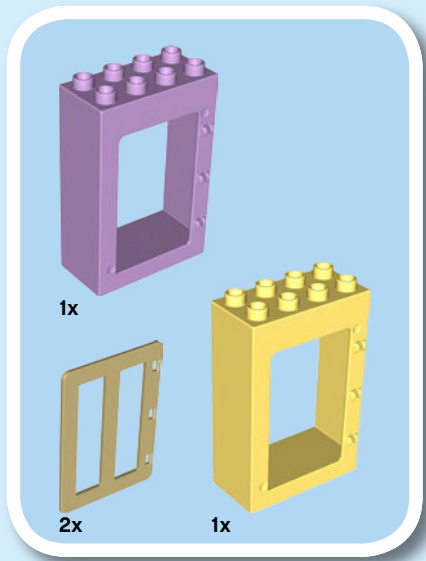

15

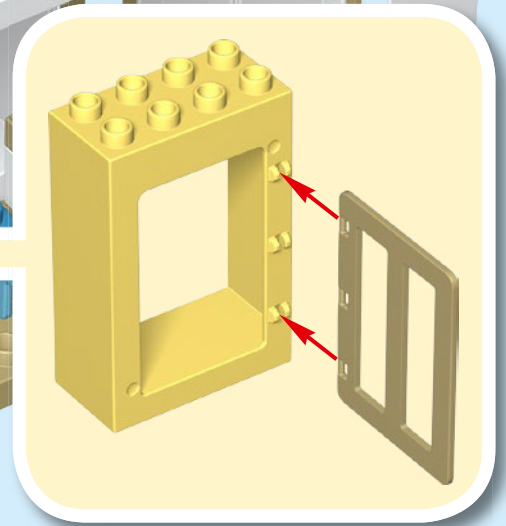
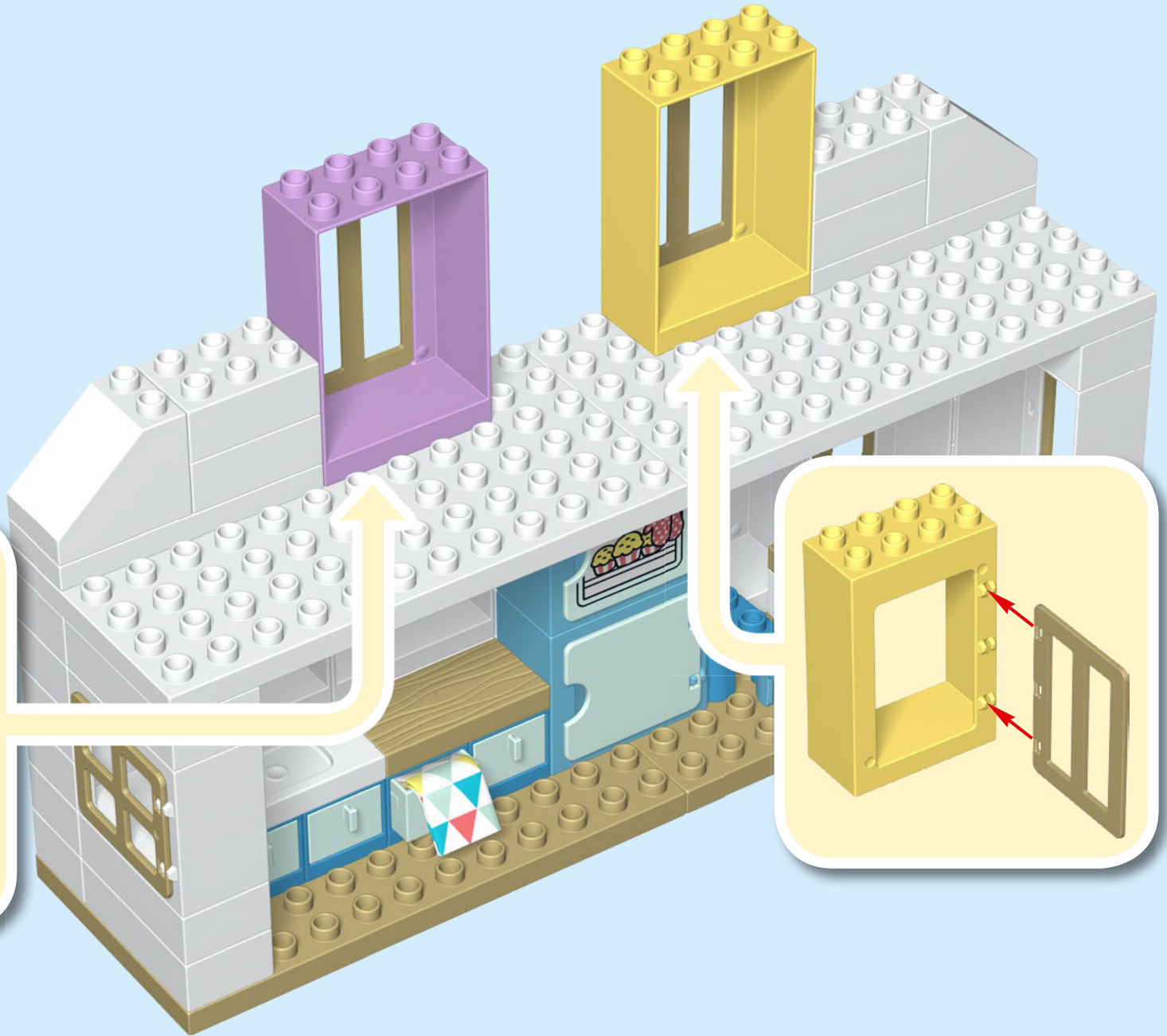
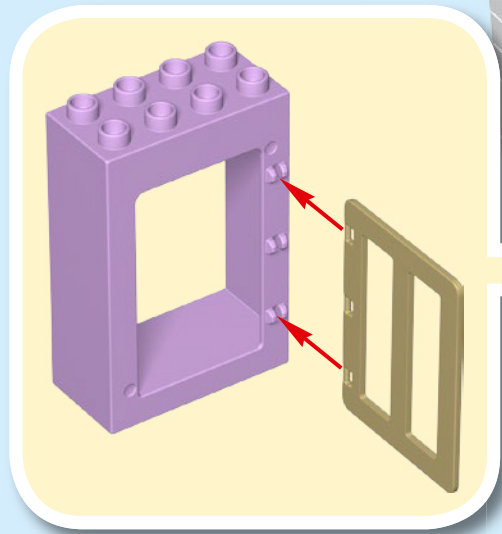

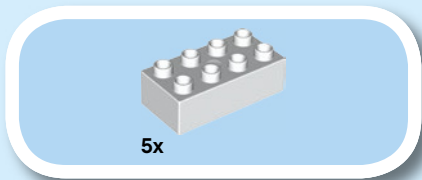

16

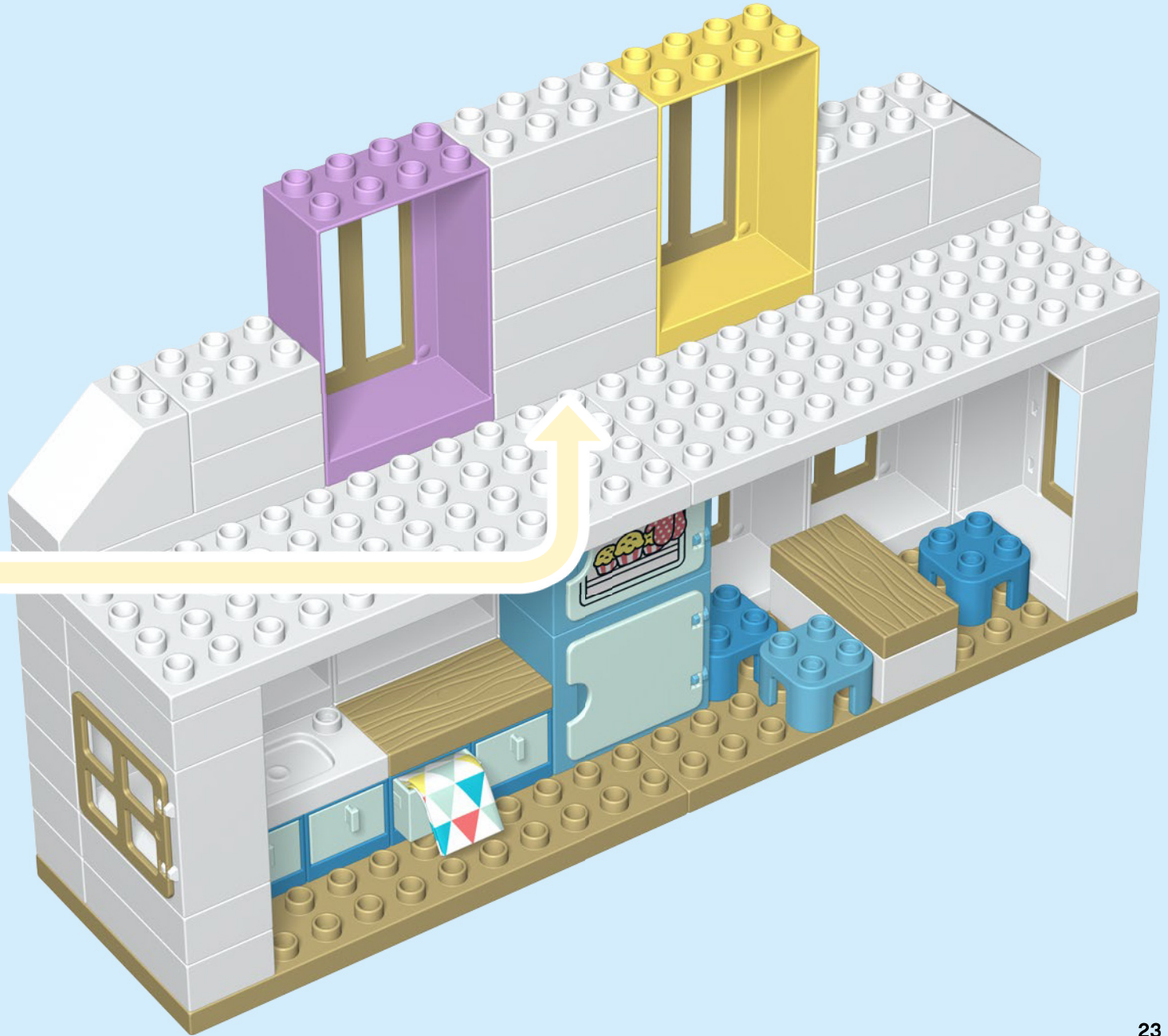
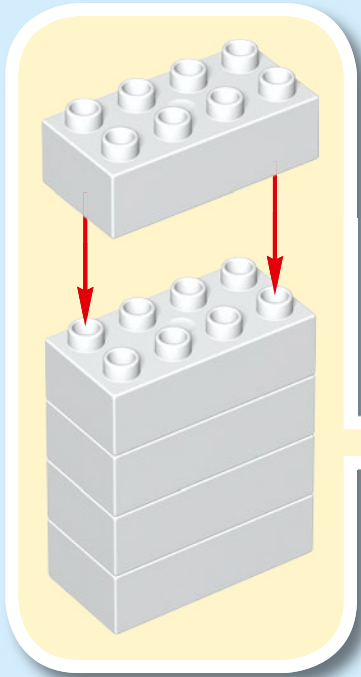

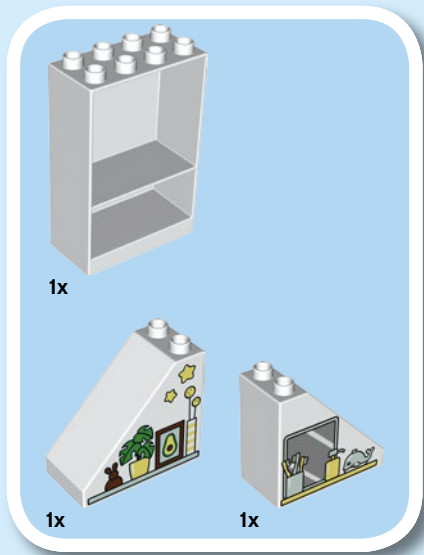

17

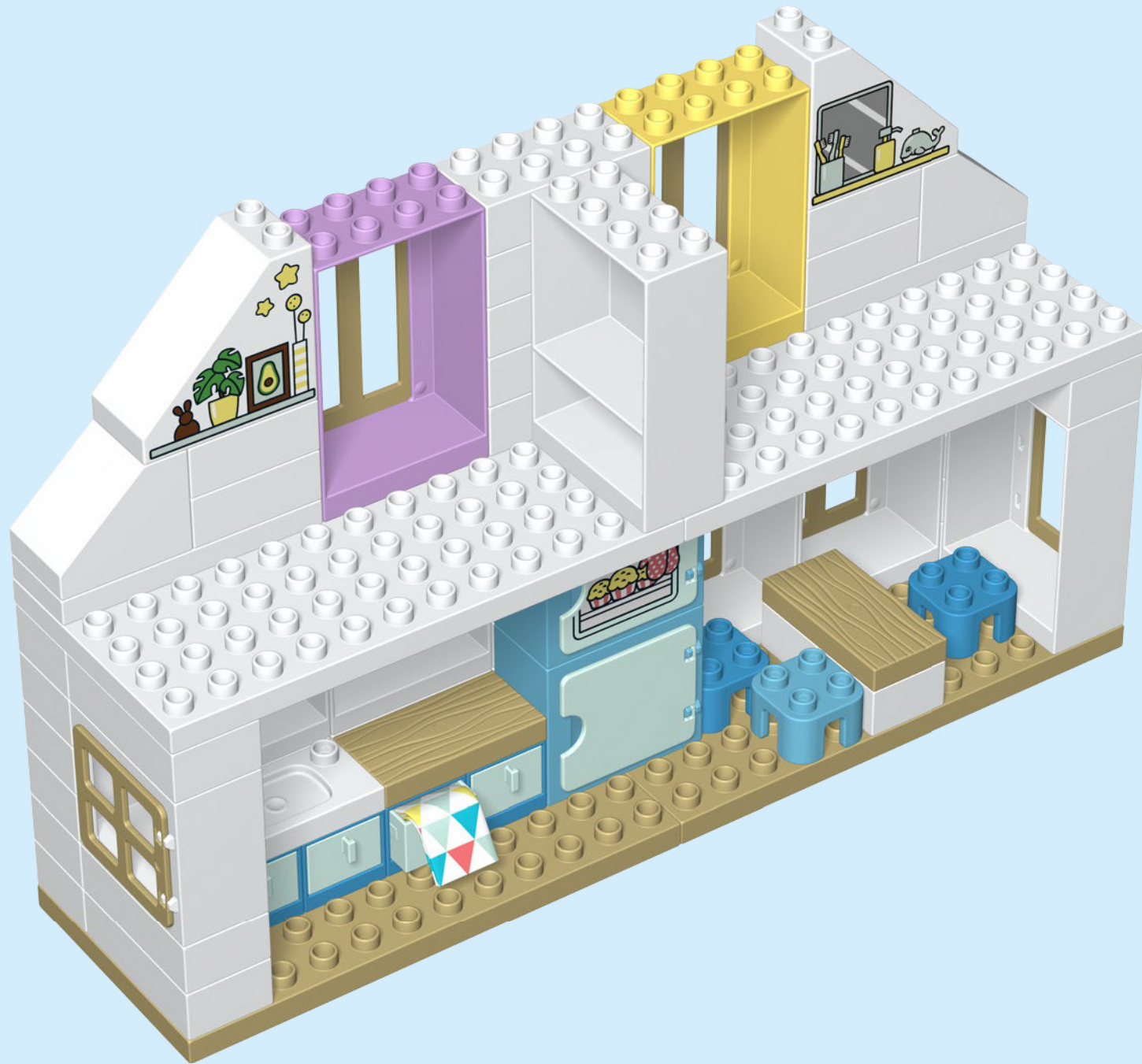

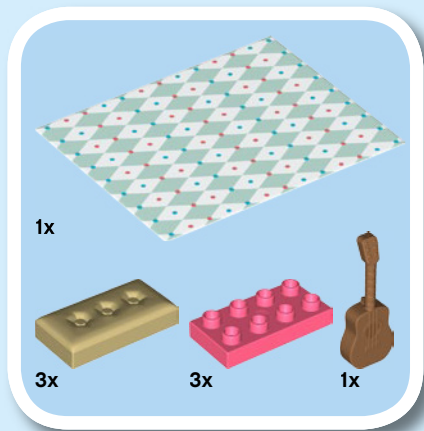

18

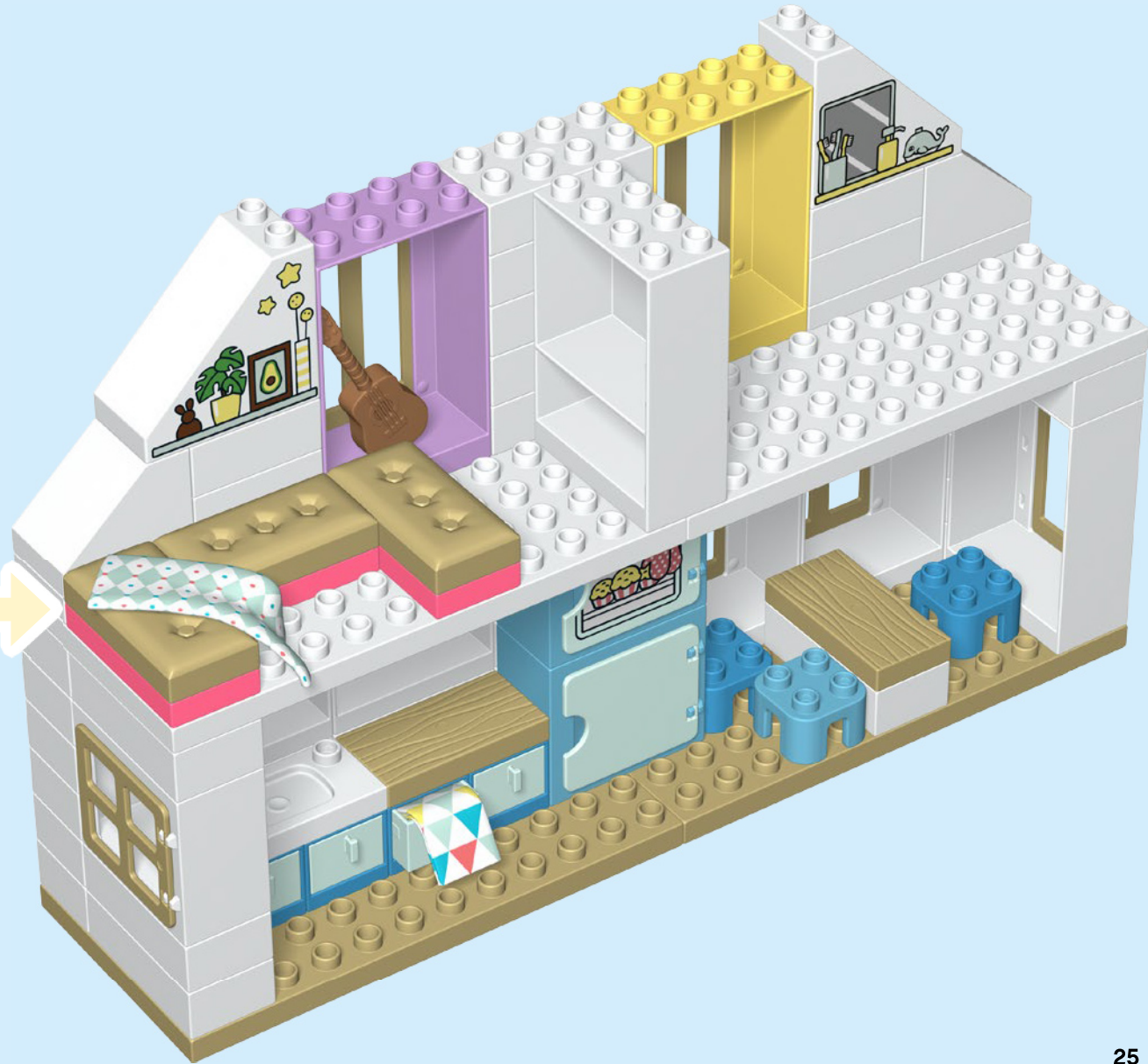
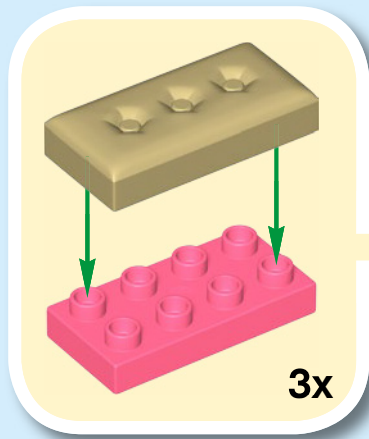

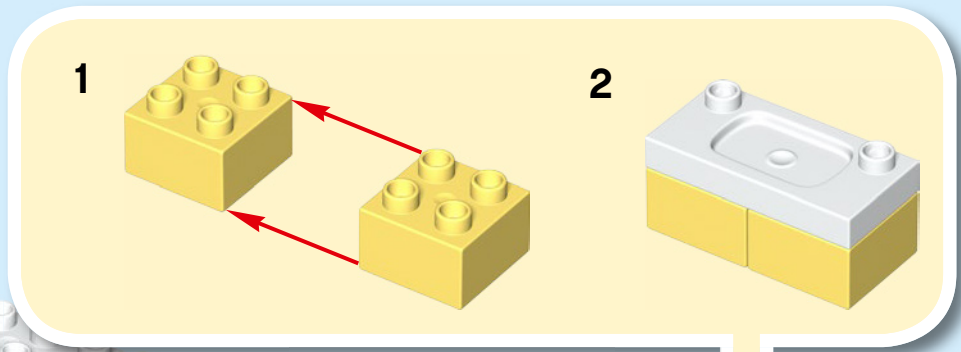
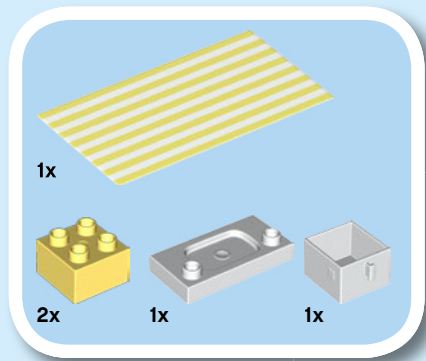

19

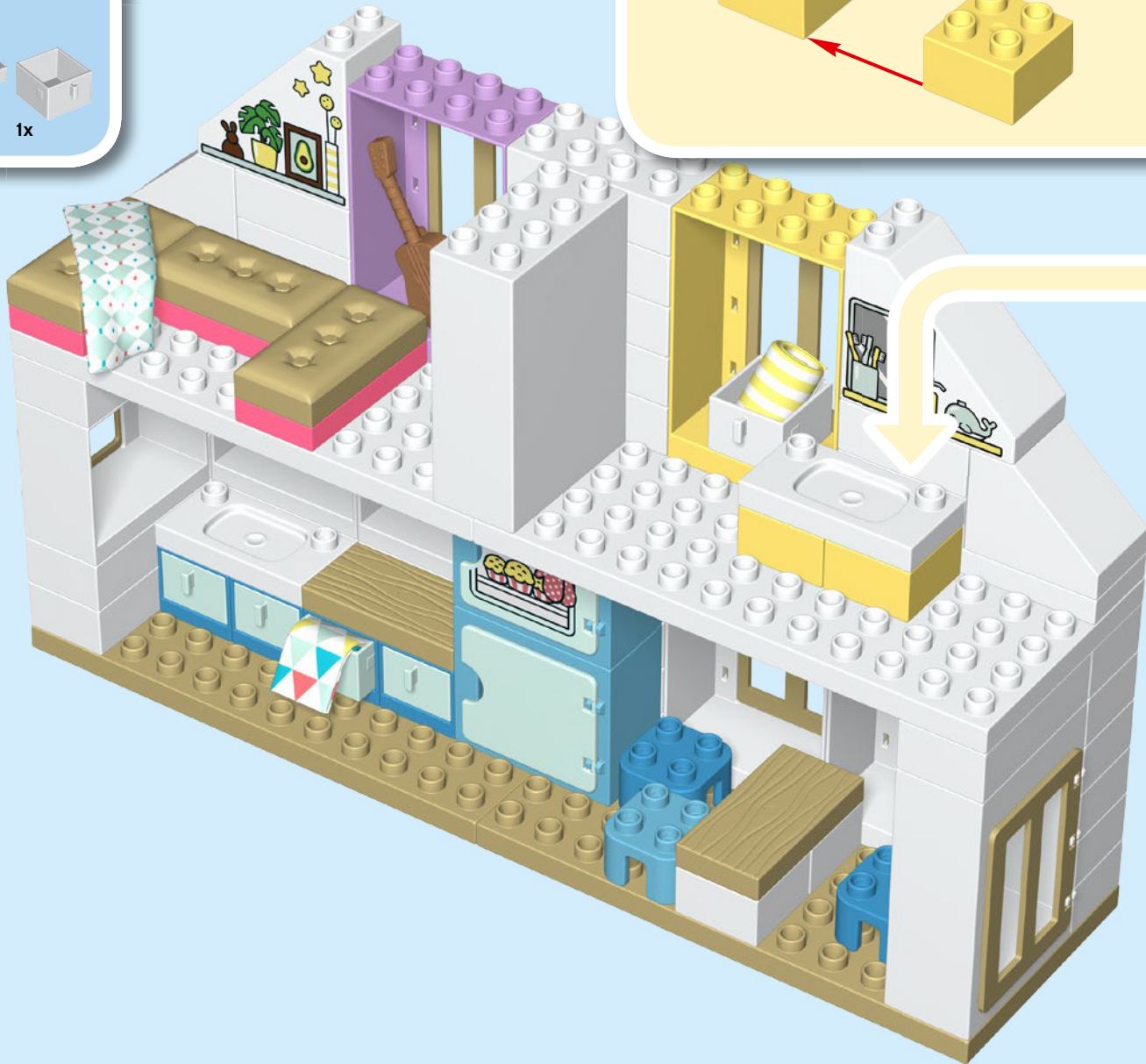

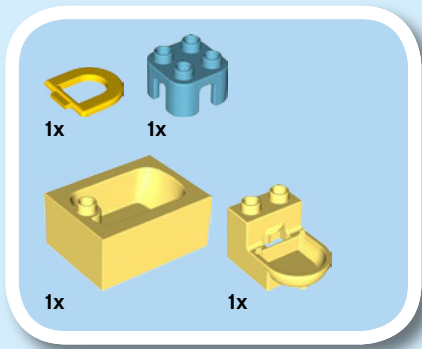

20

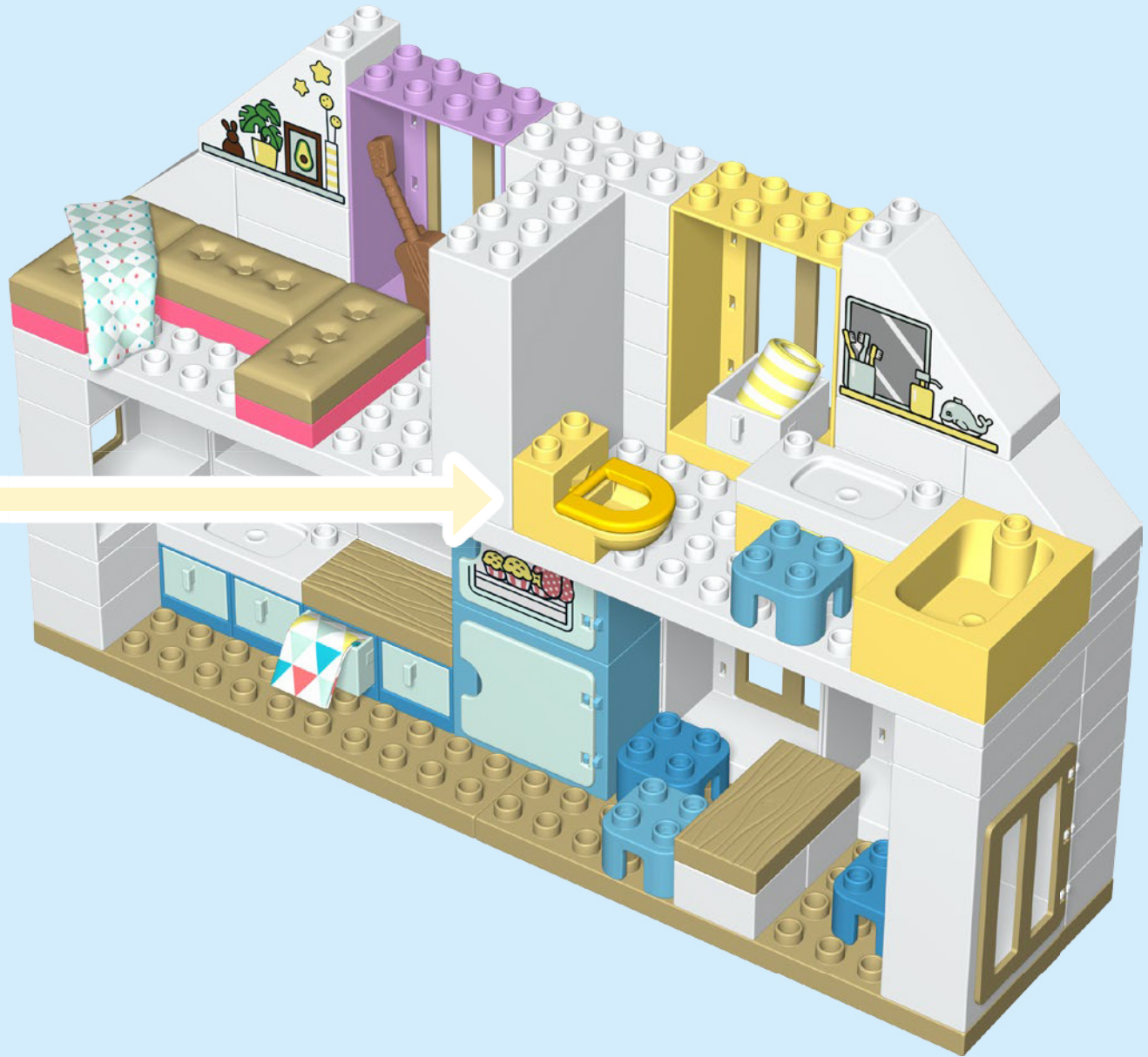
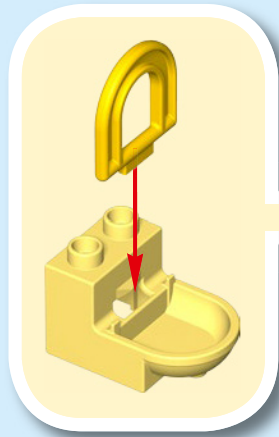

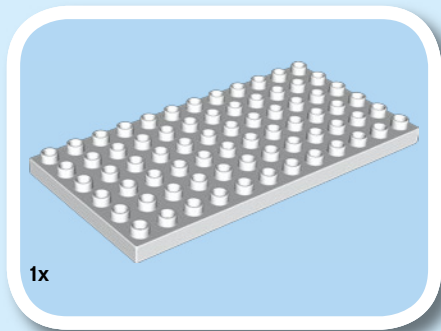

21

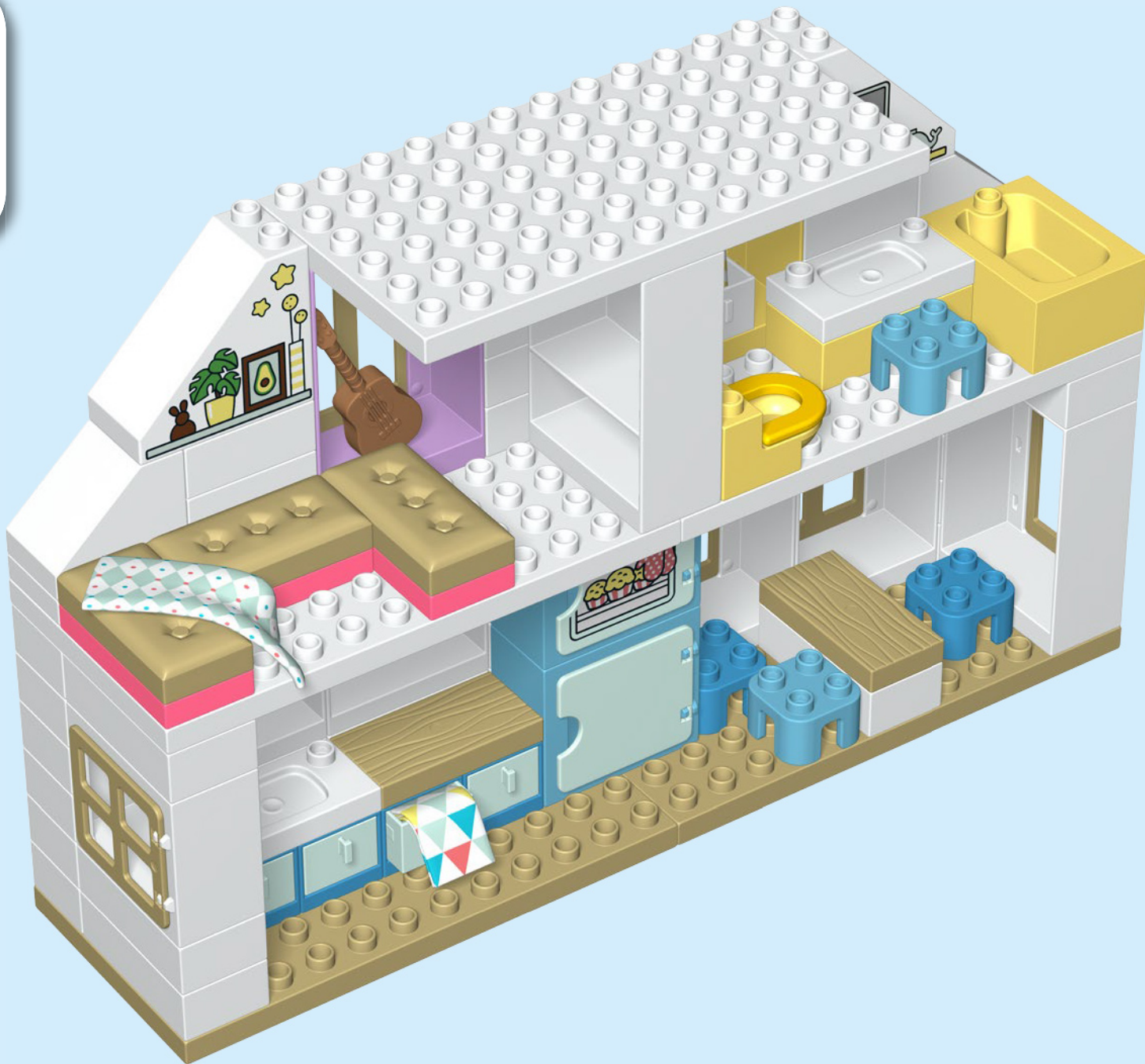

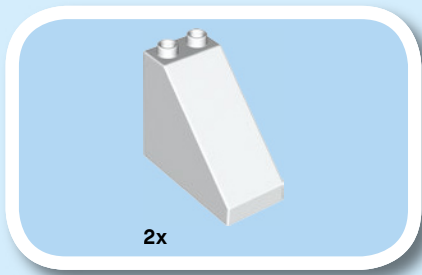

22

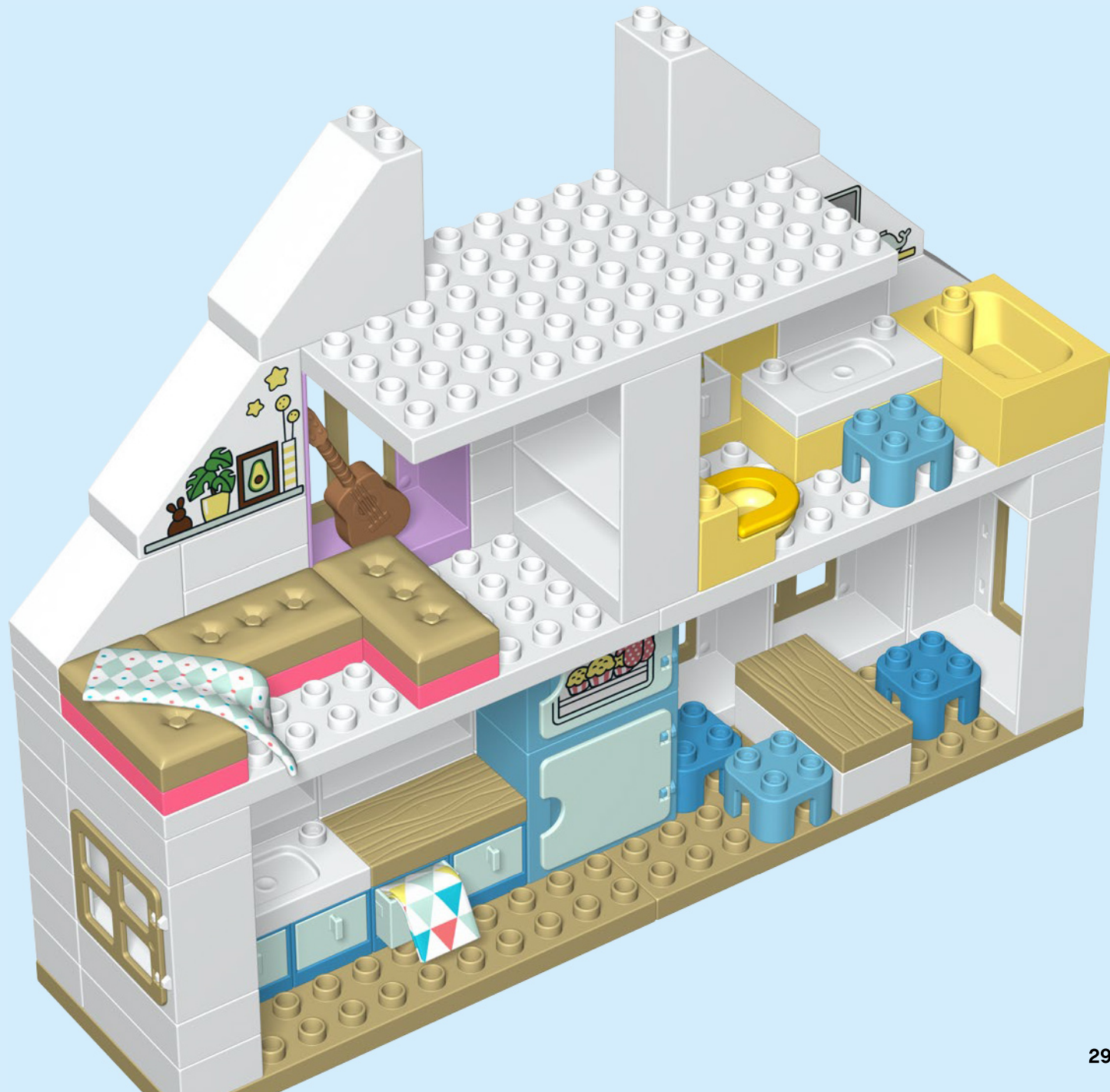

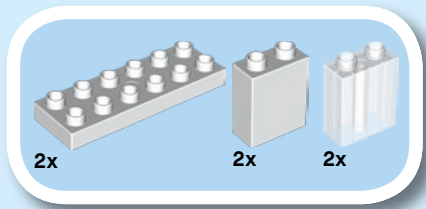

23

1

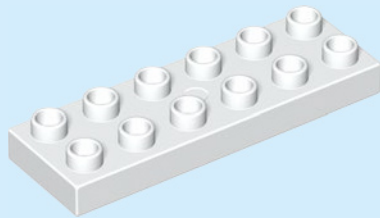

2

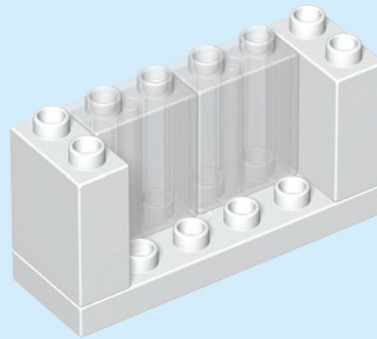

3



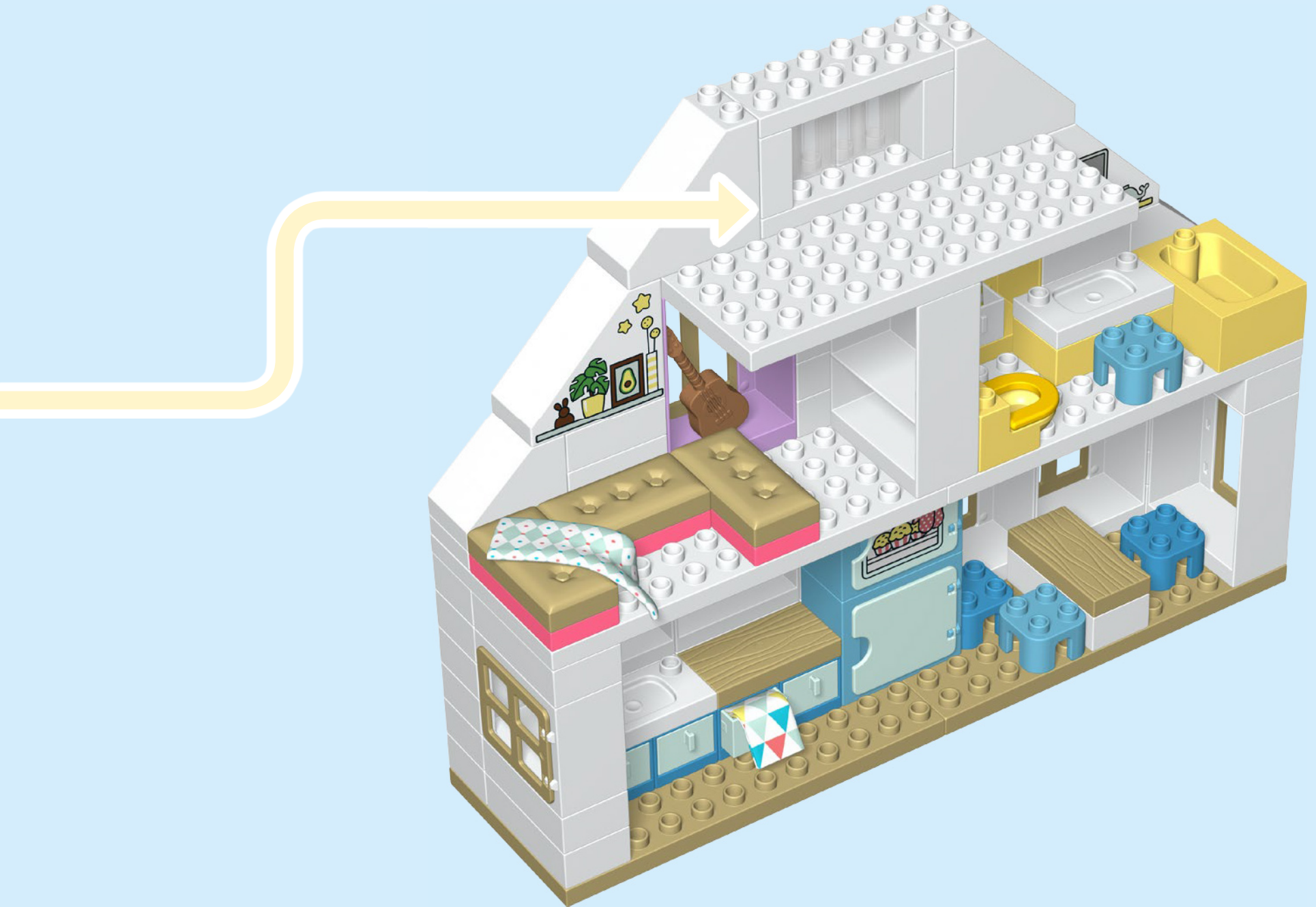

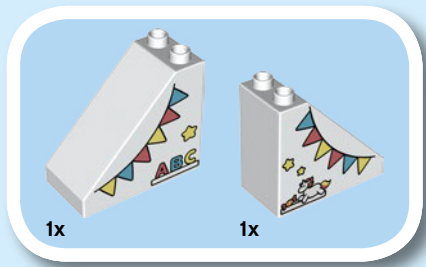

24

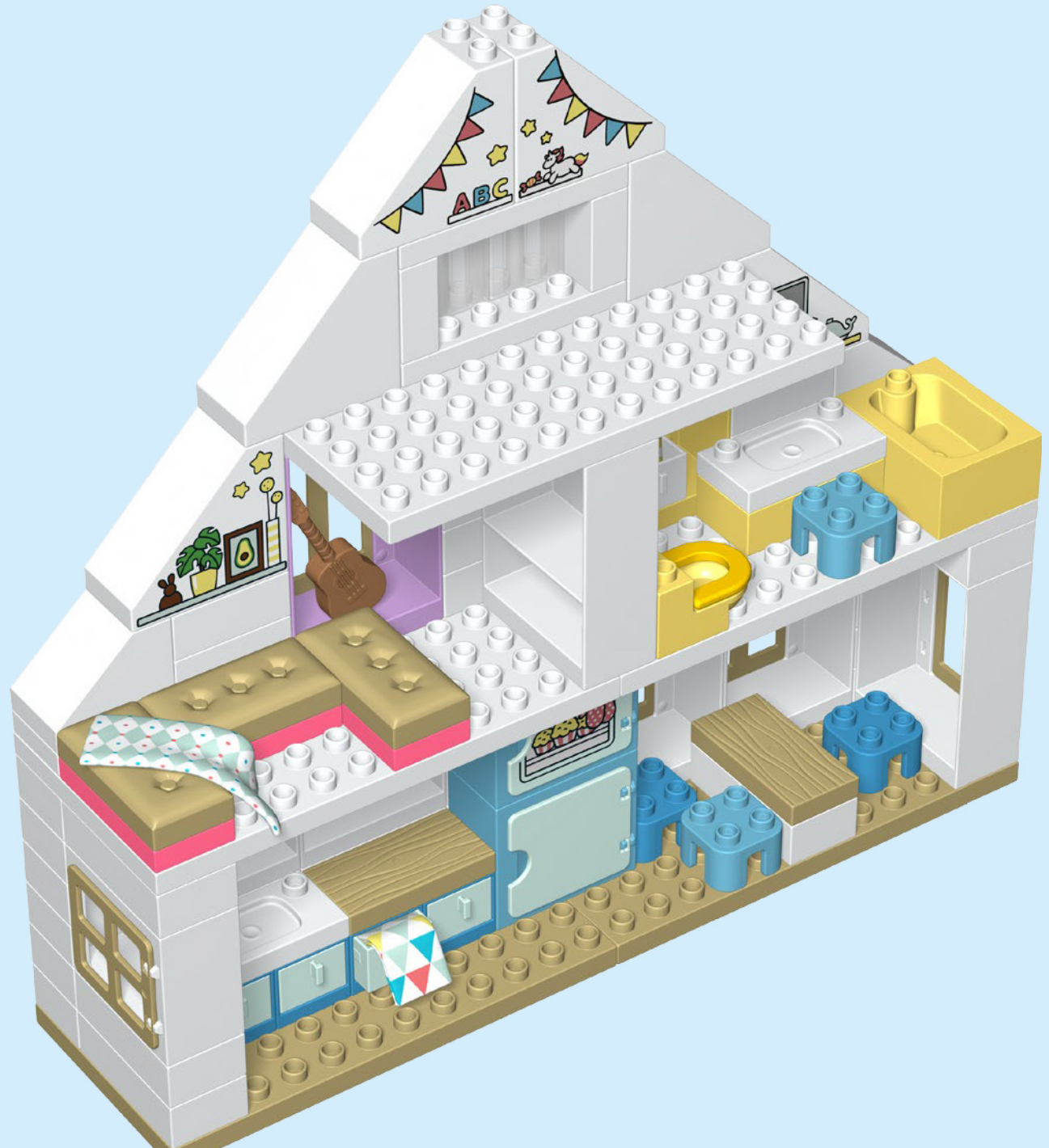

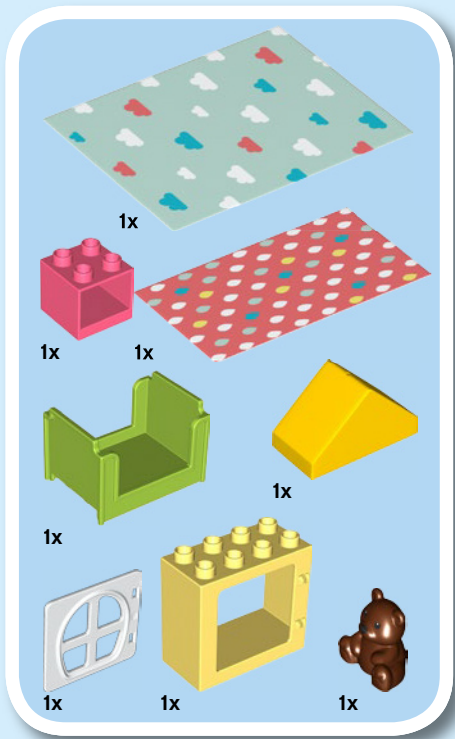

25

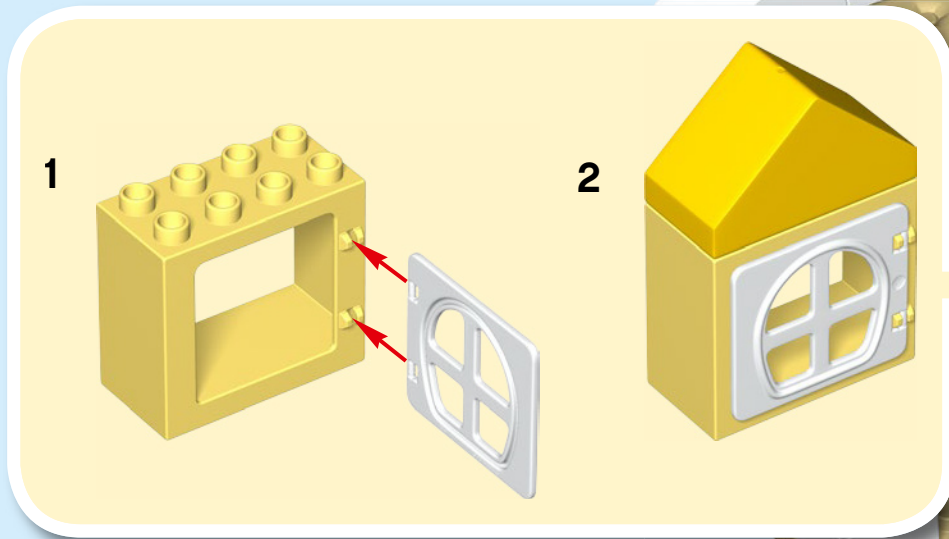



26





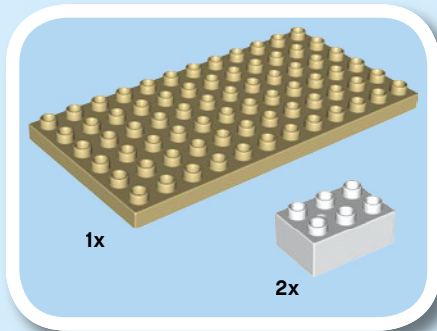
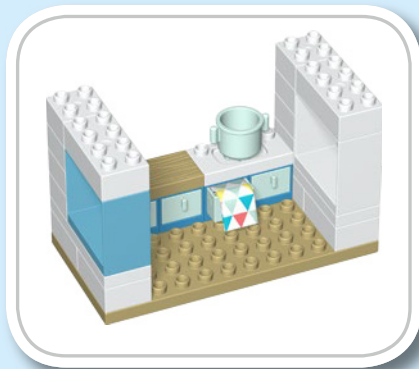

1

EXTRA
IDEAS
INCLUDED

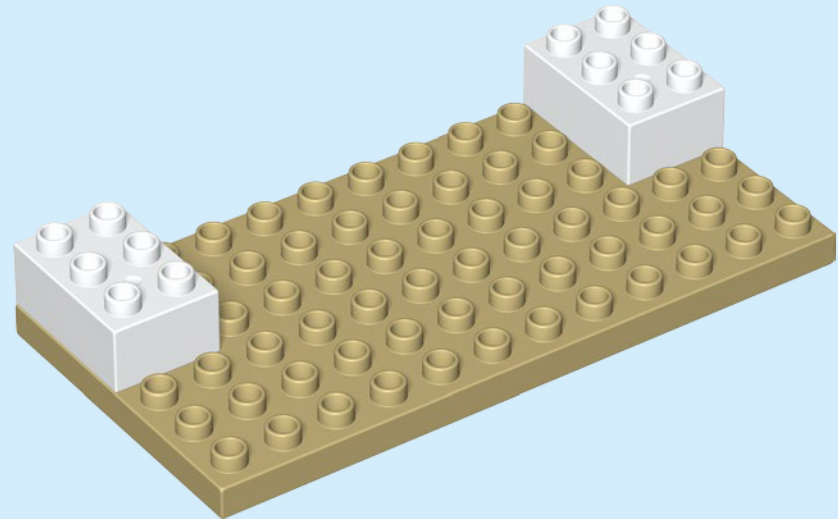

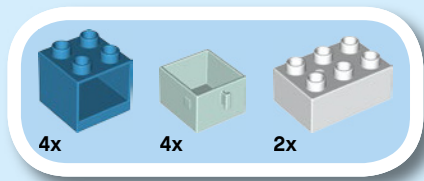

2

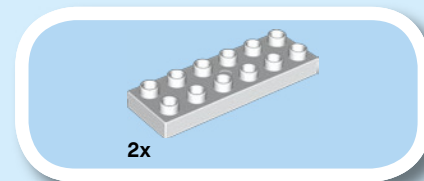
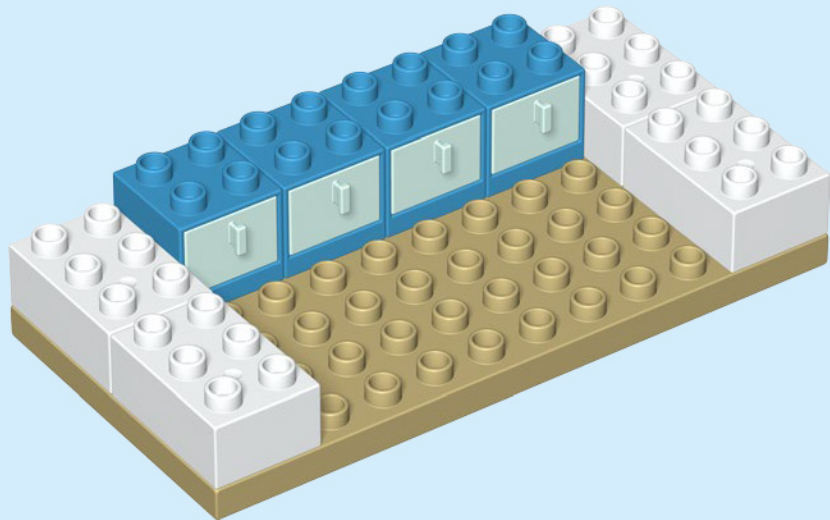
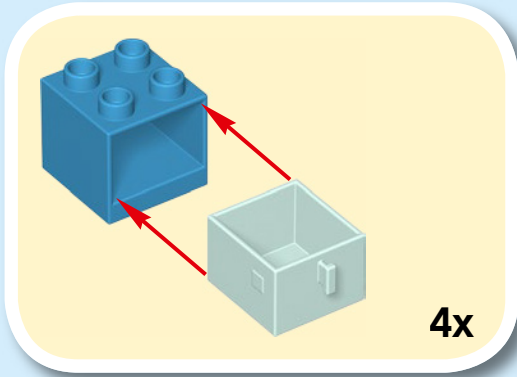

3

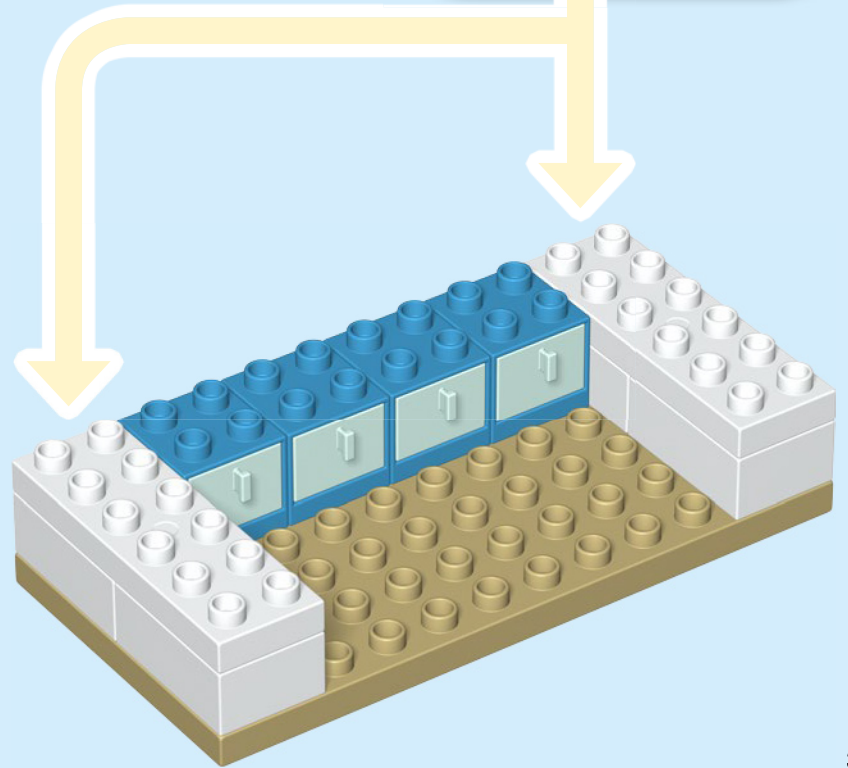
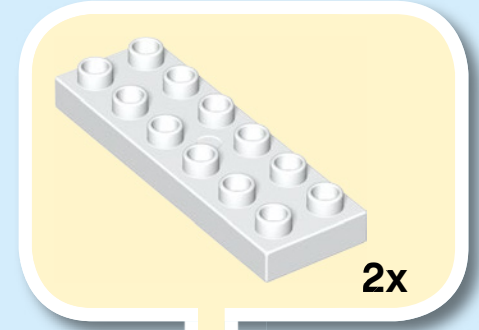

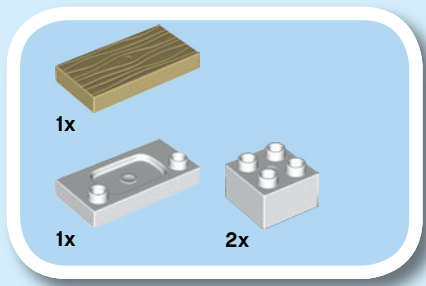

4

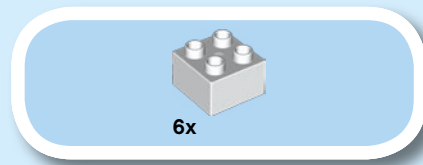
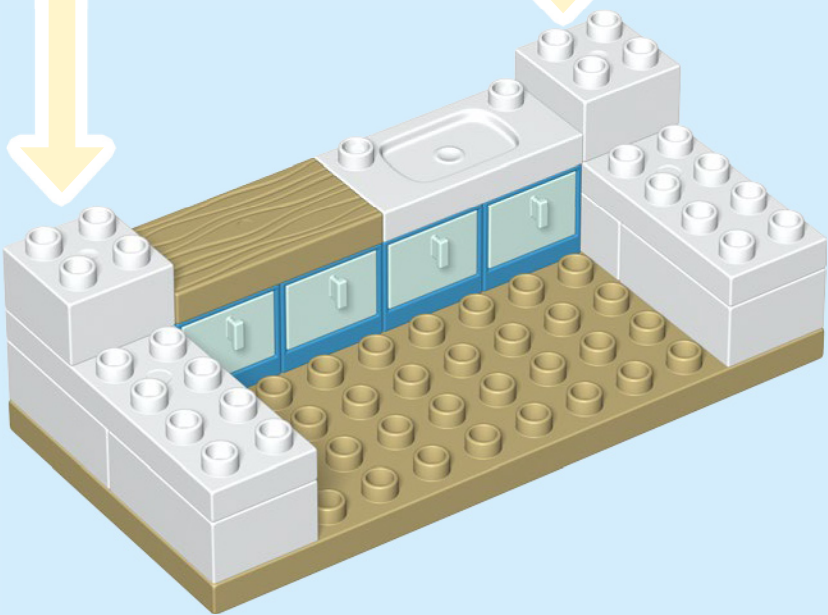
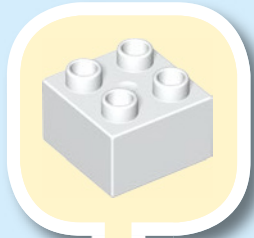

5

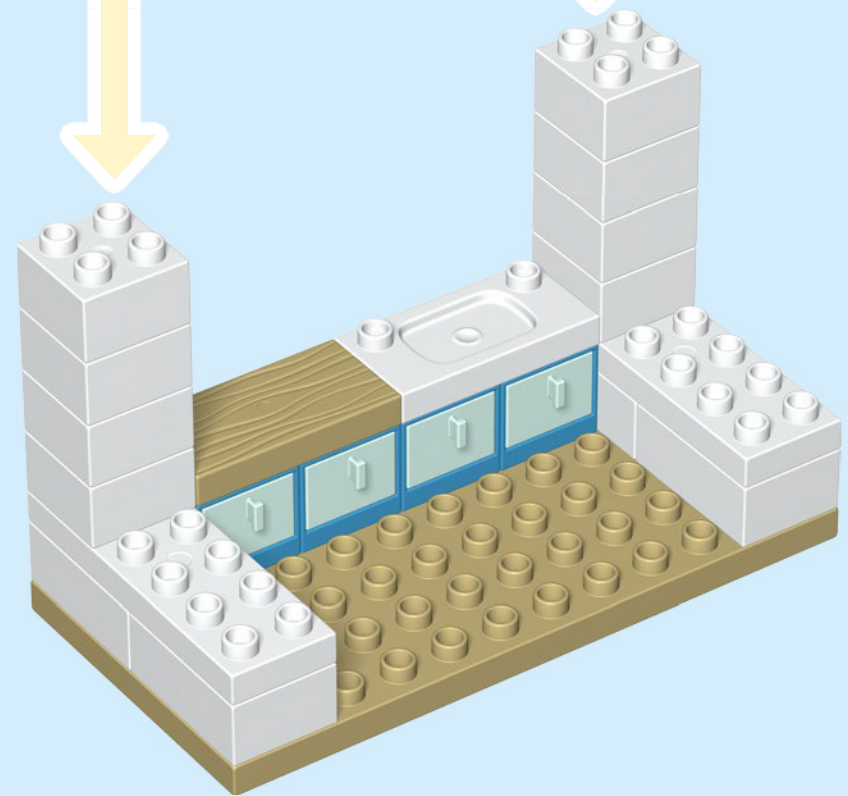
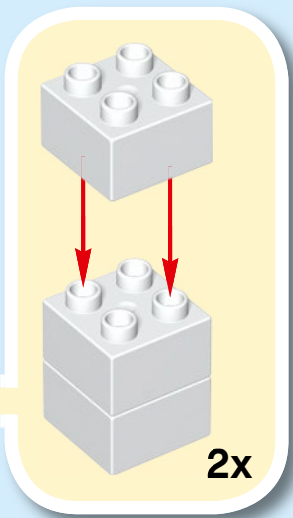

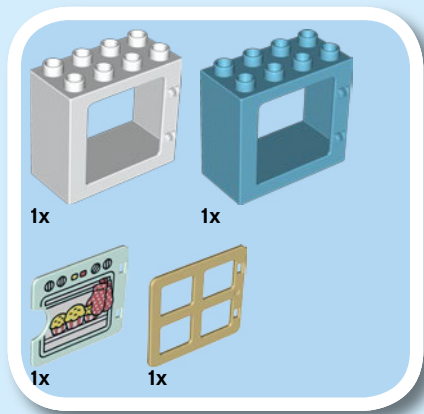

6

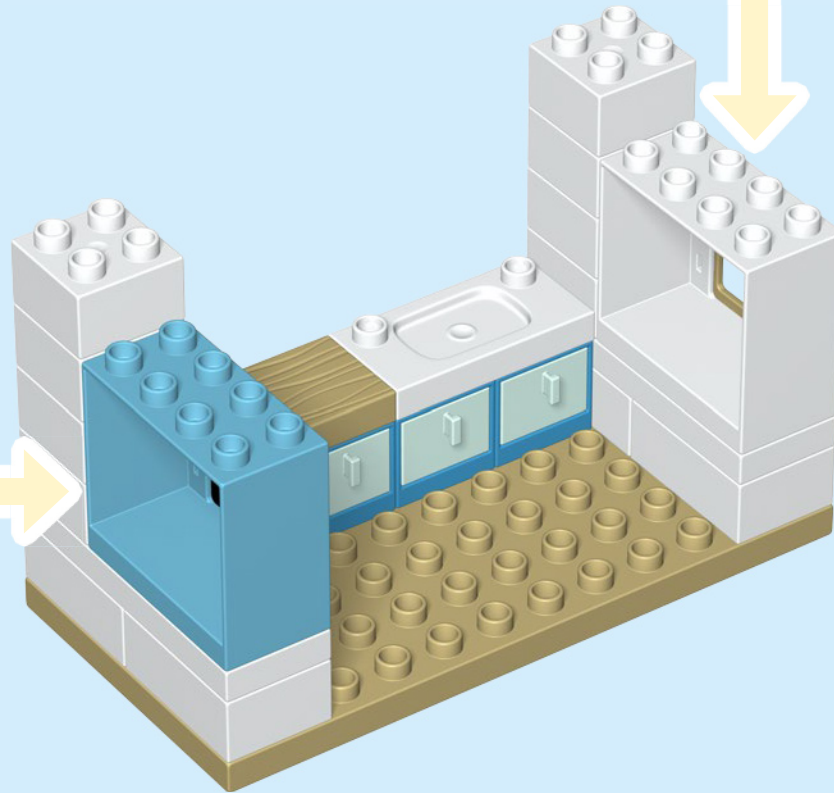
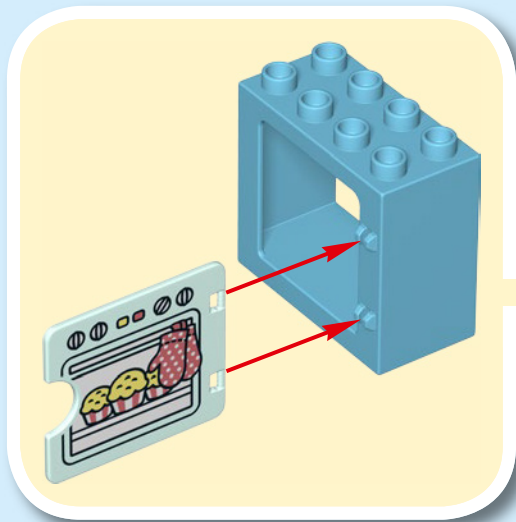
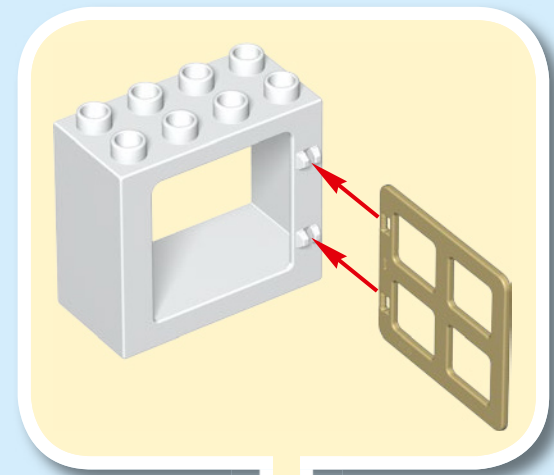

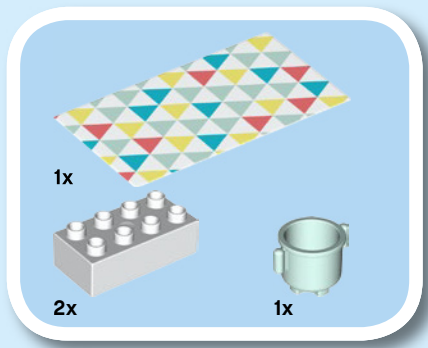

7

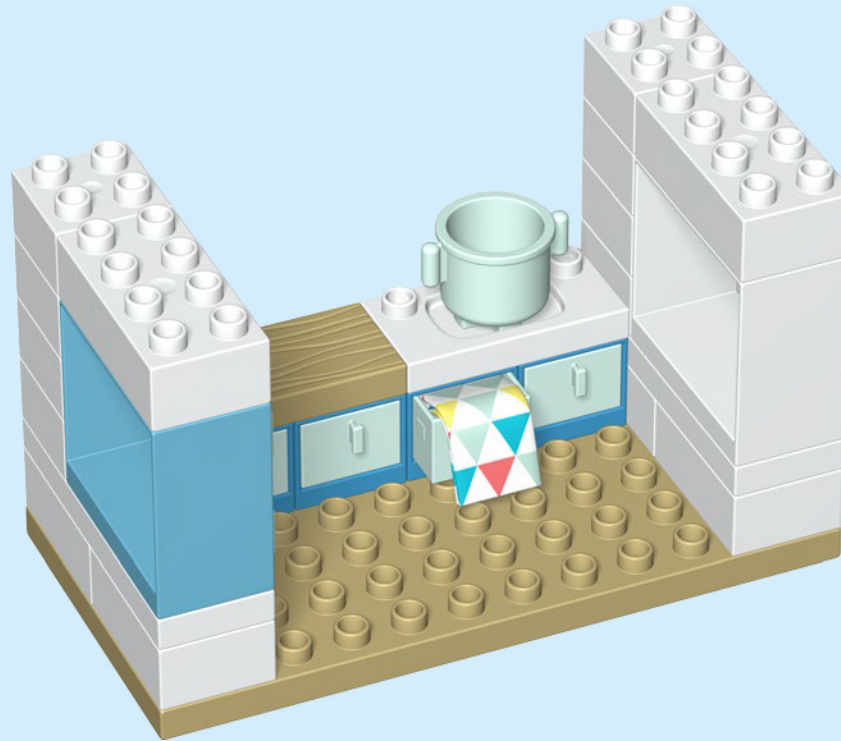

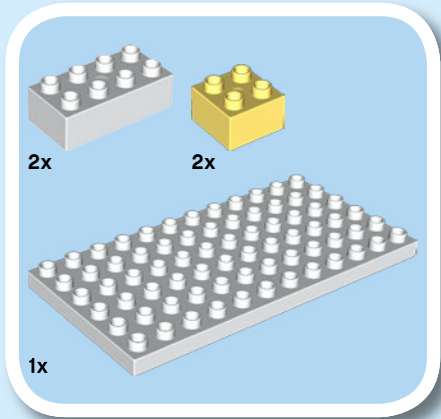

8

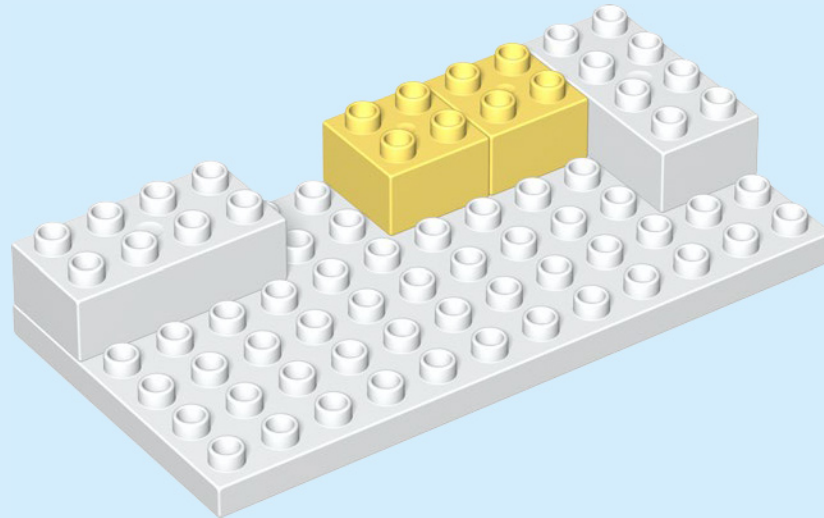

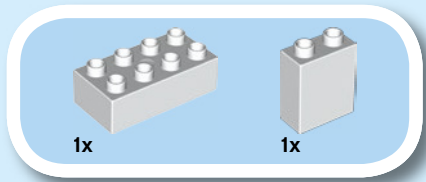

9

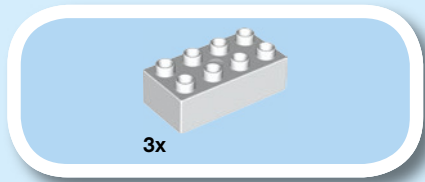
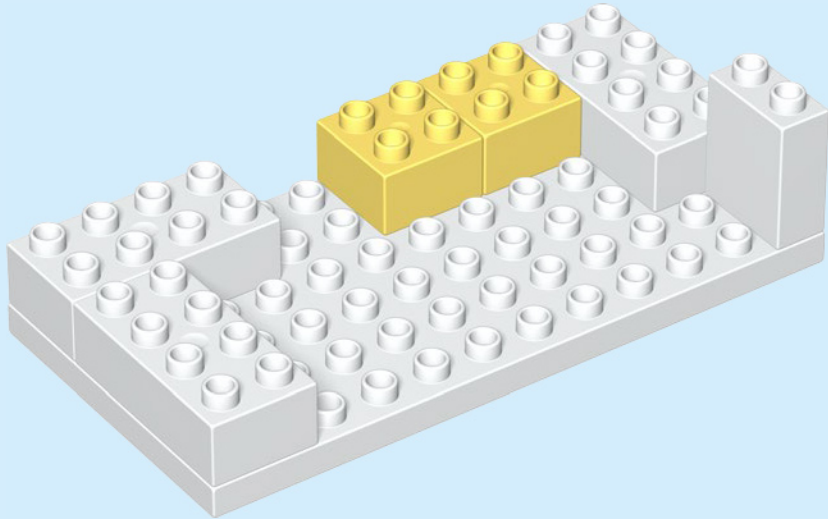

10

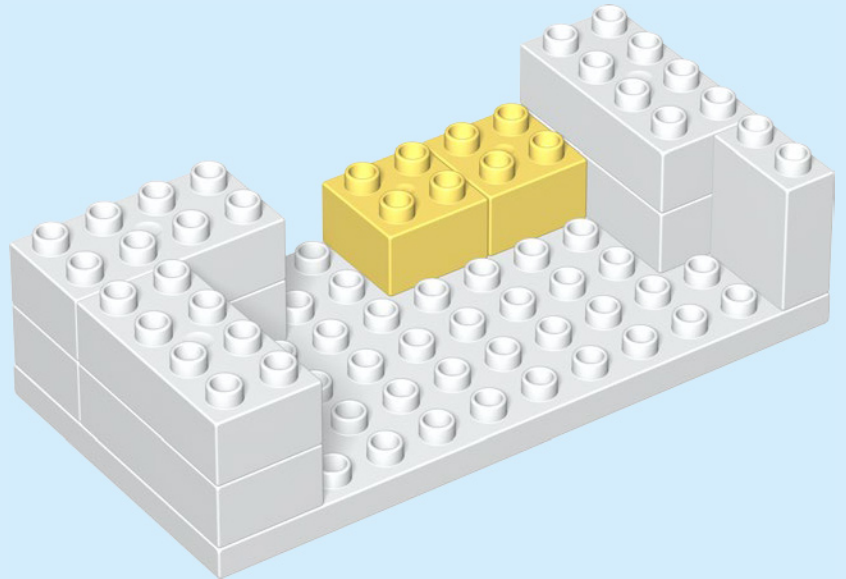

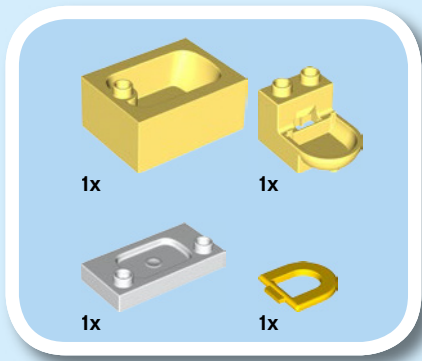

11

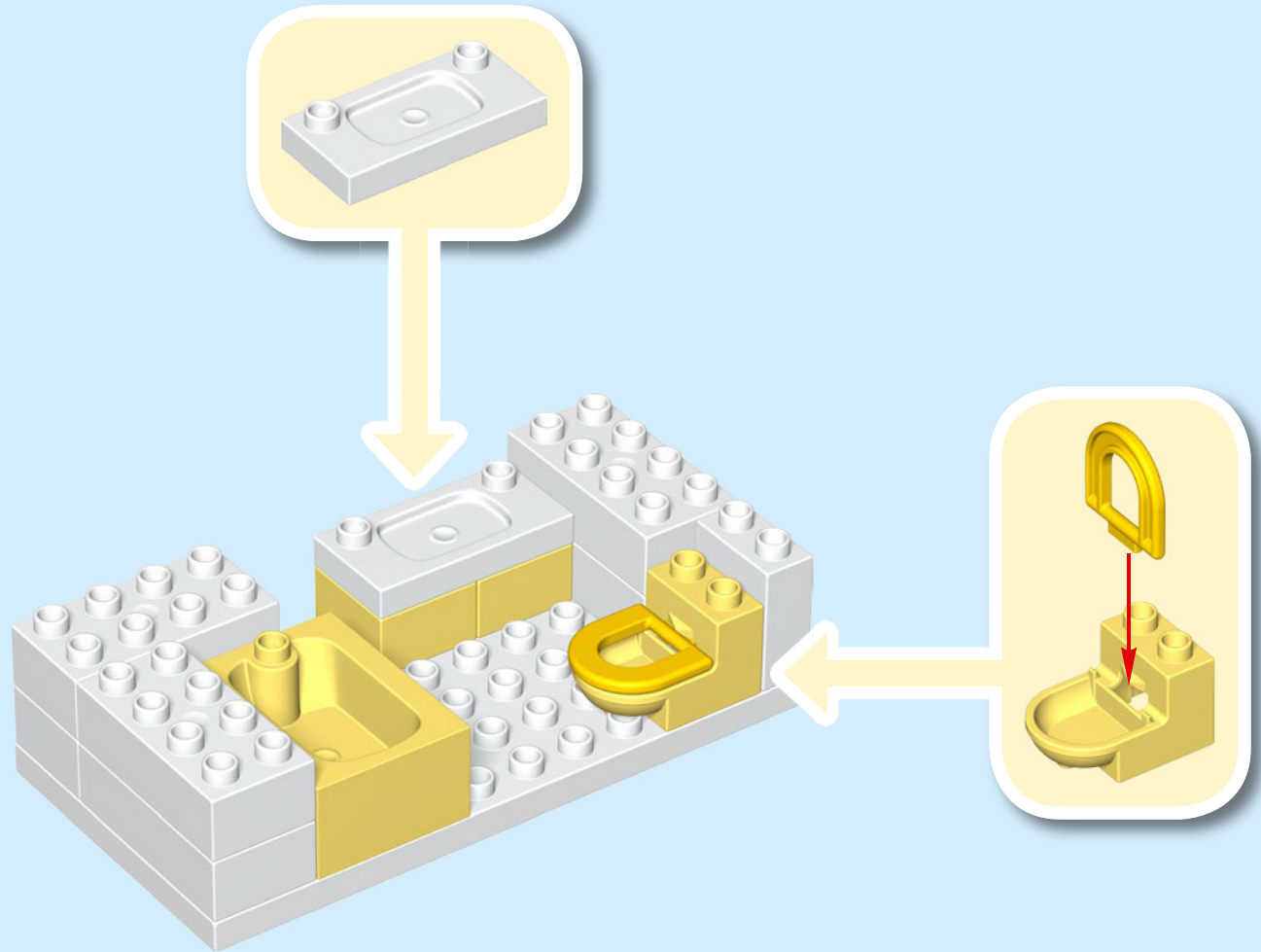

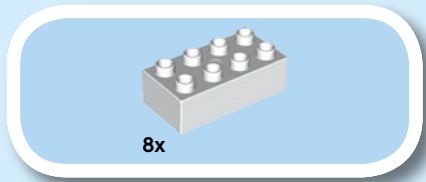

12

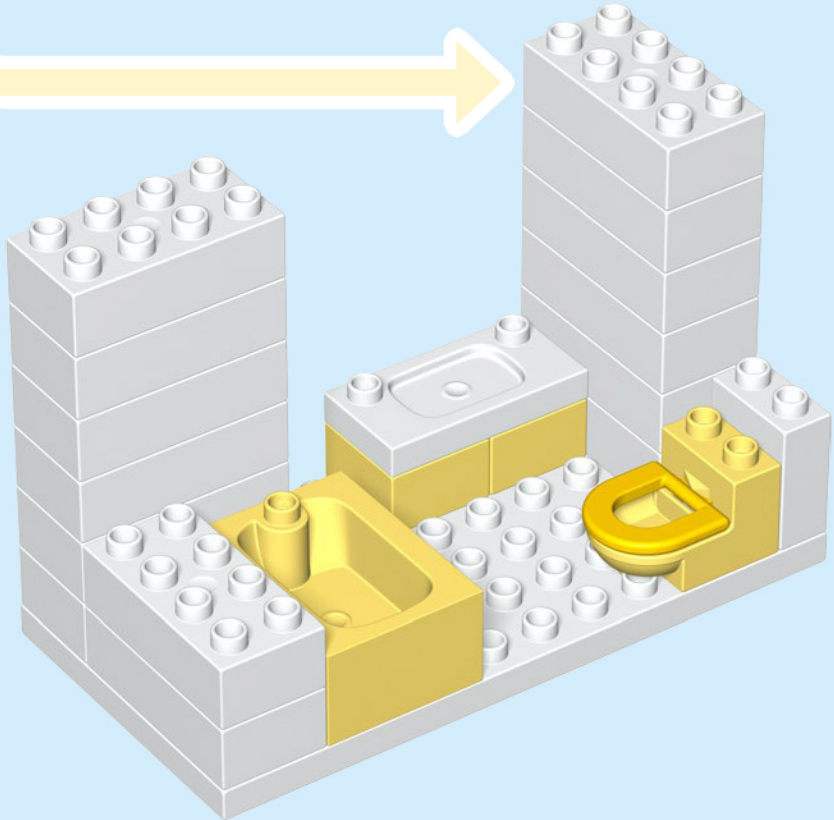
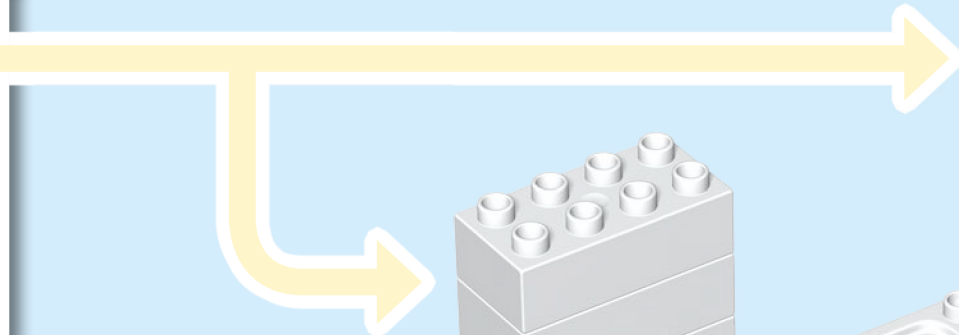
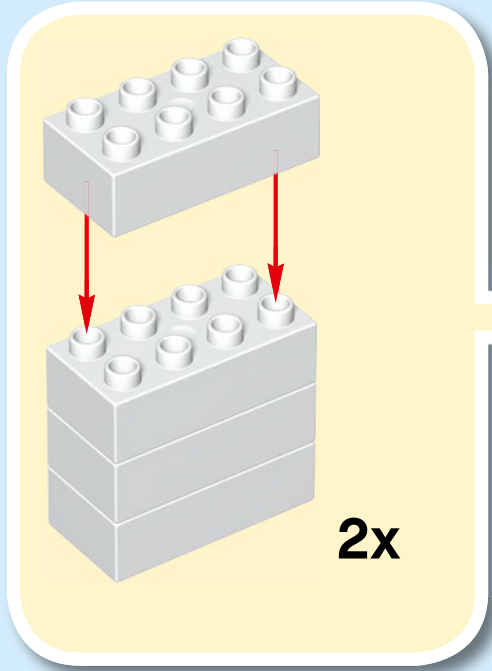

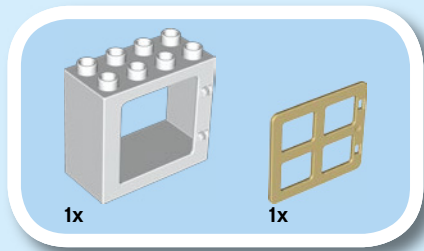

13

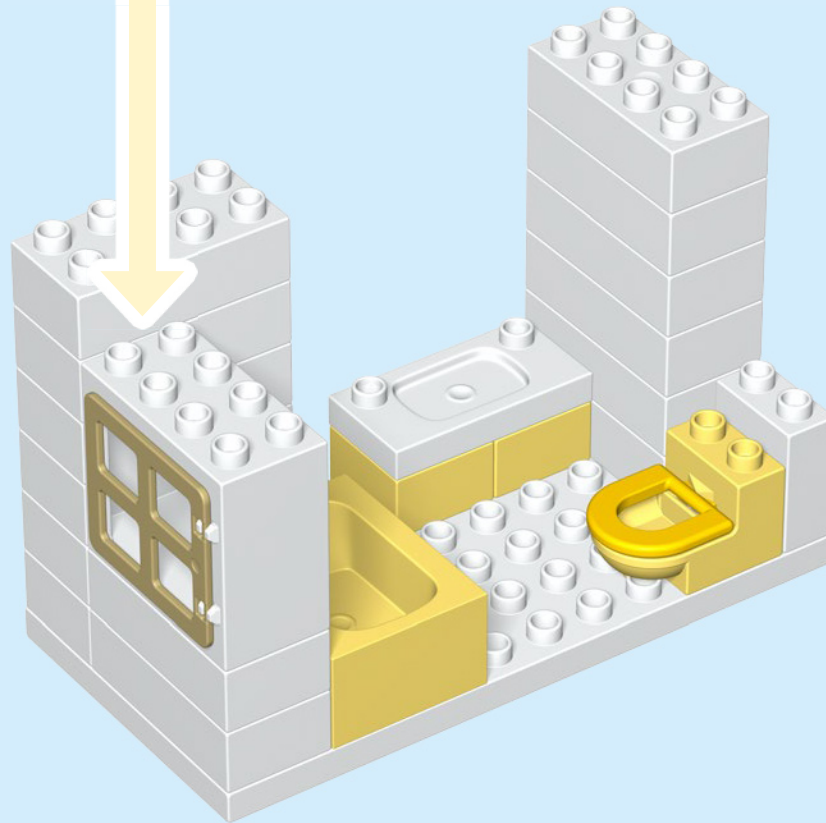
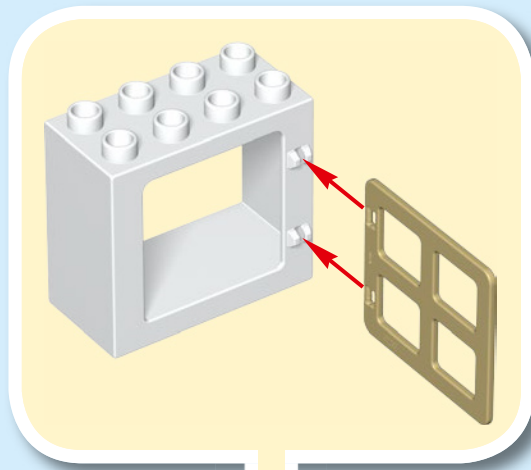

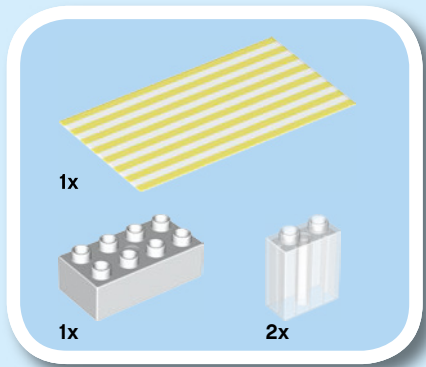

14

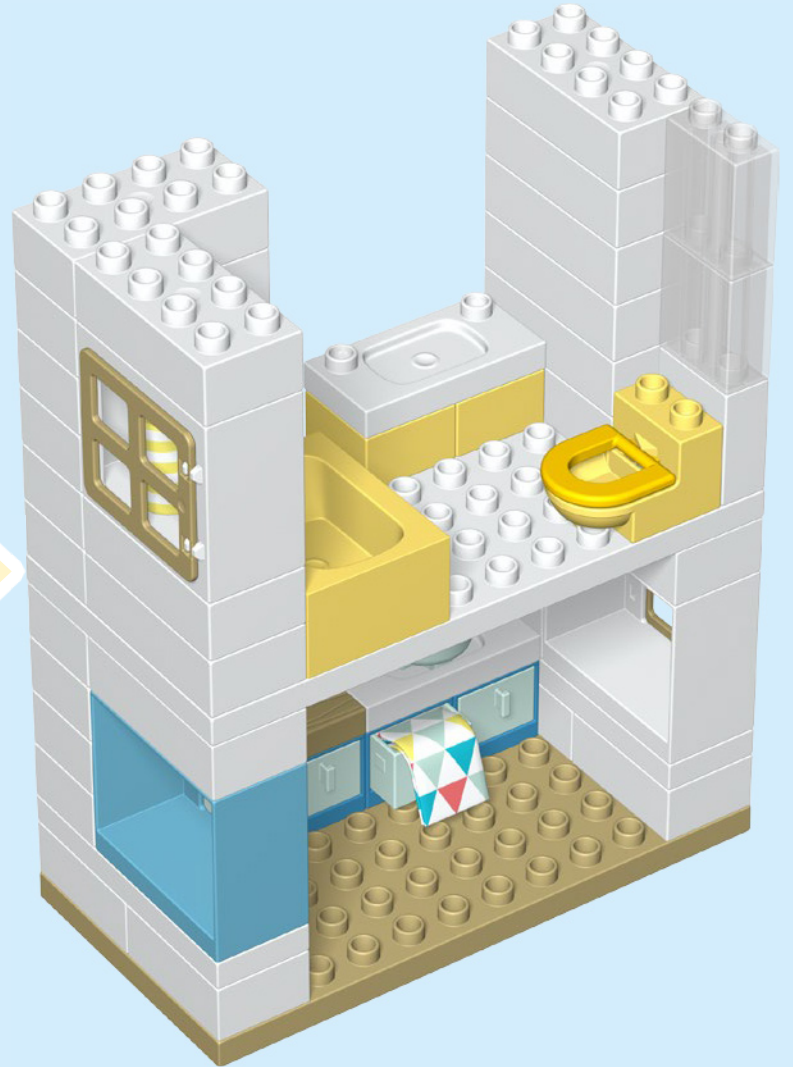
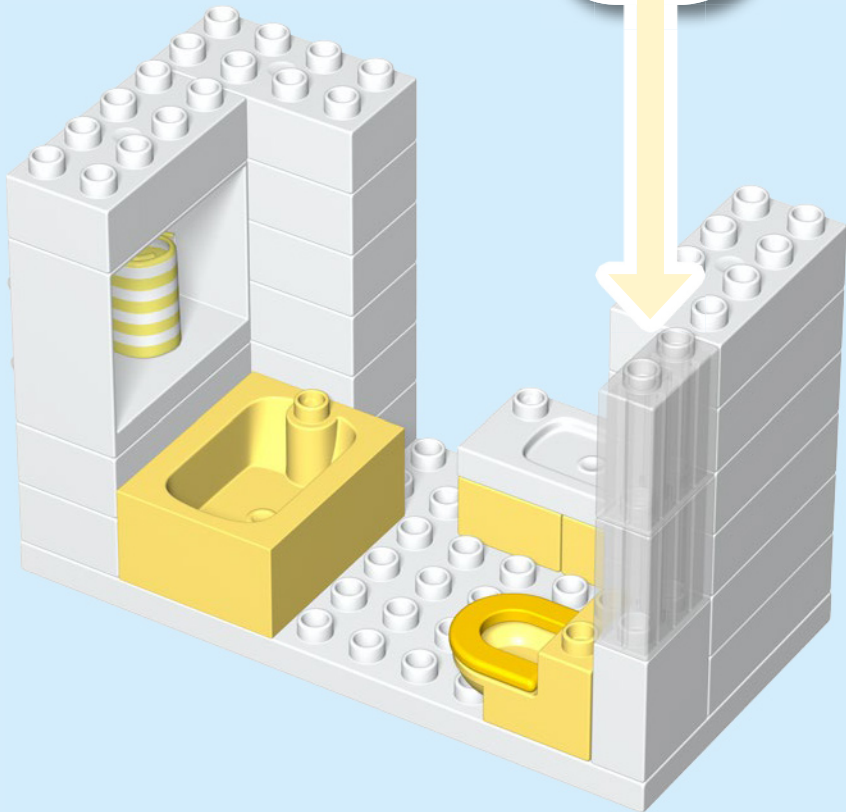
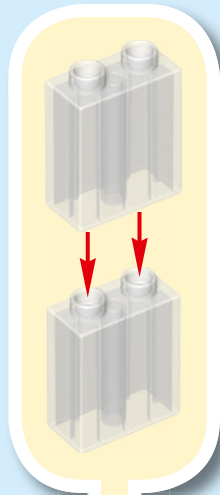

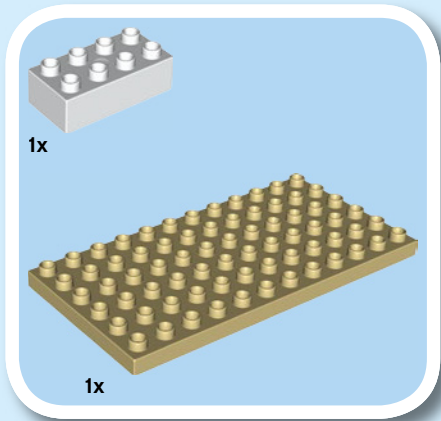

15

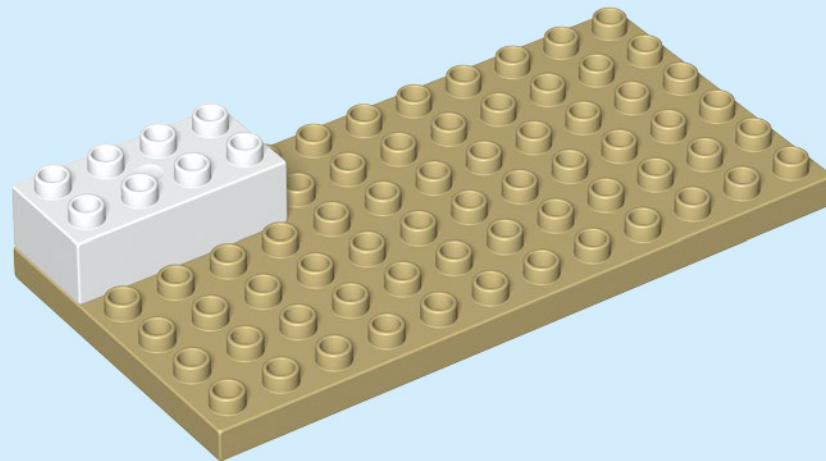

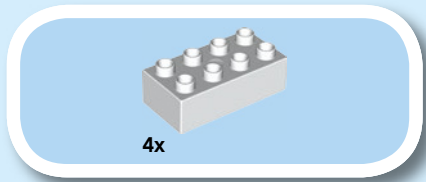

16

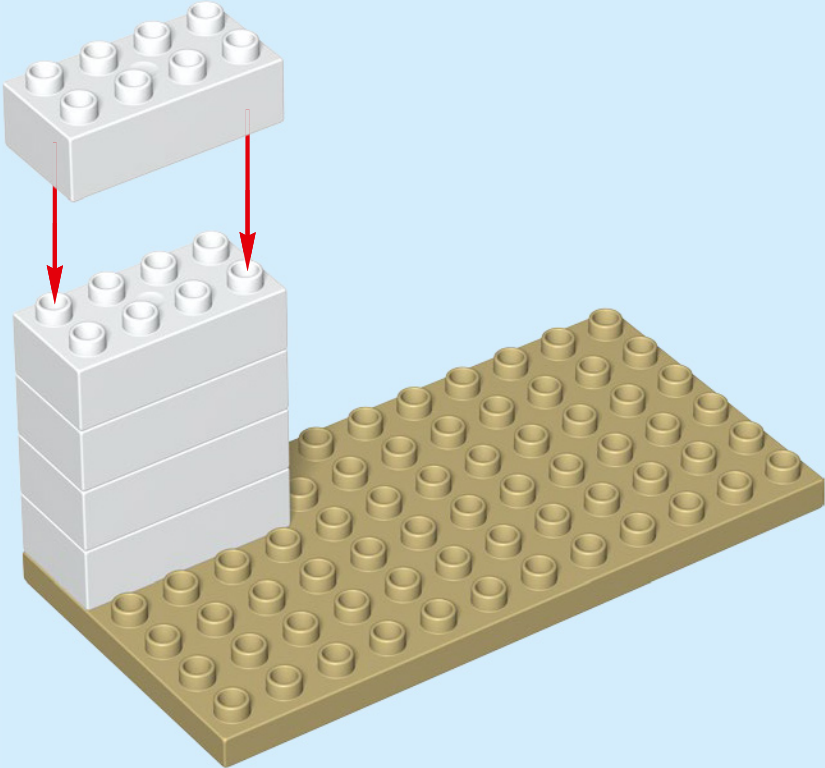

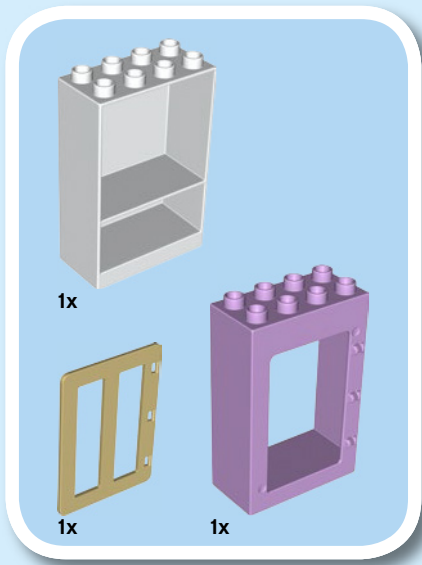

17

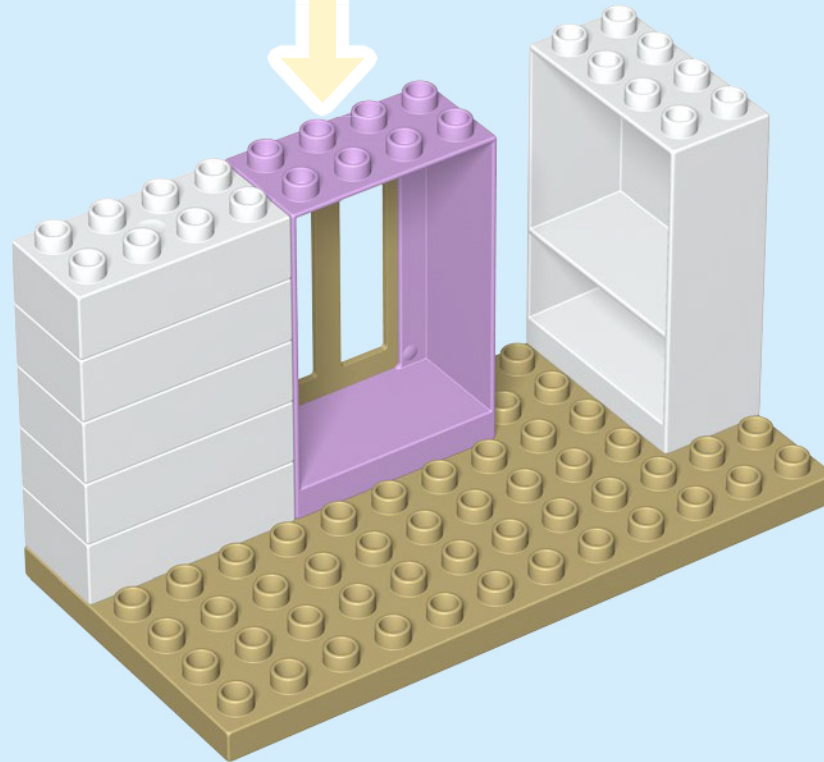
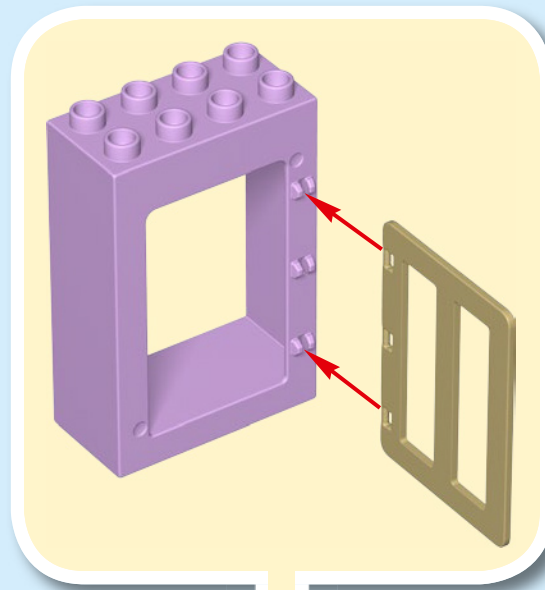

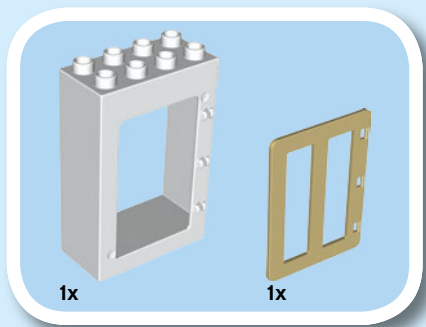

18

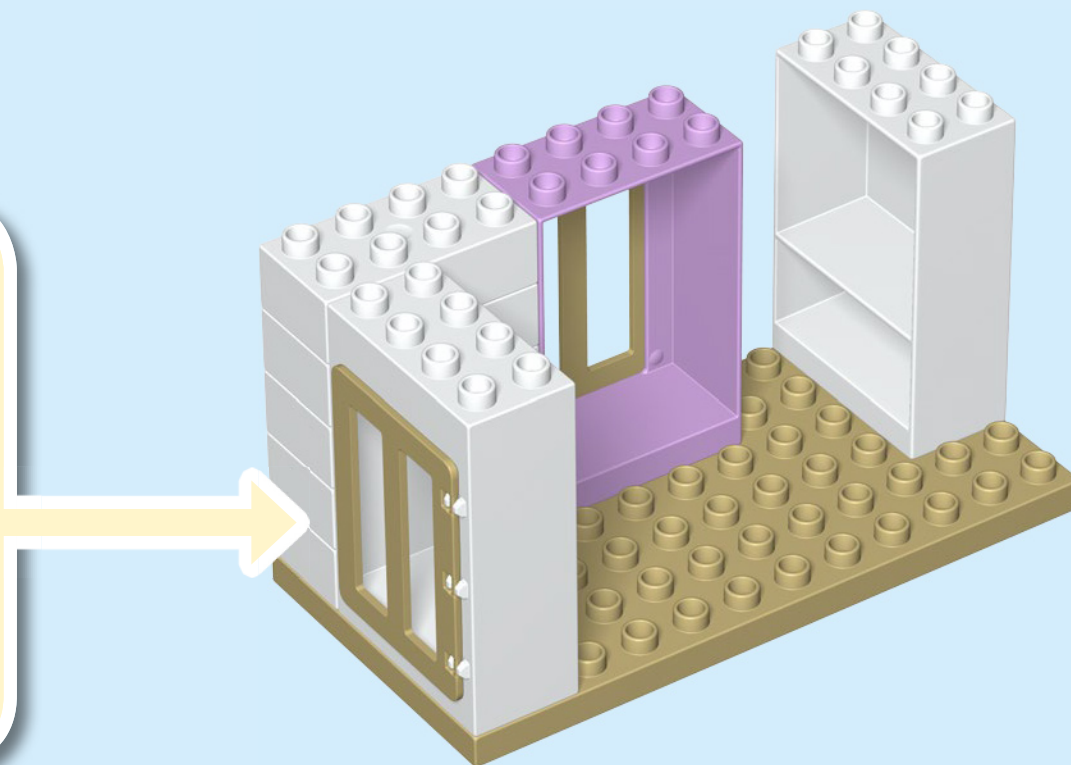
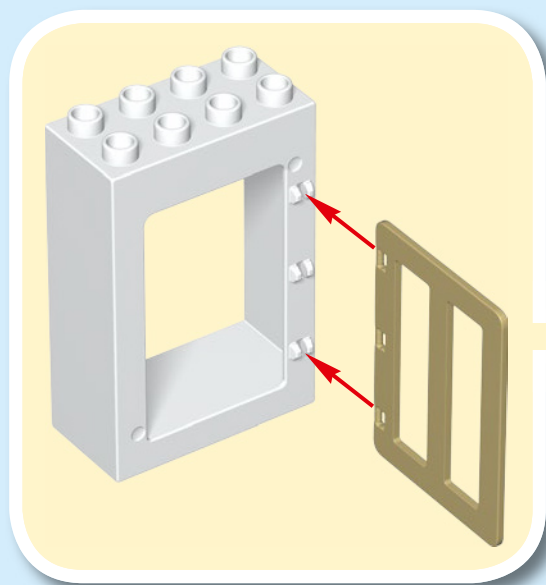

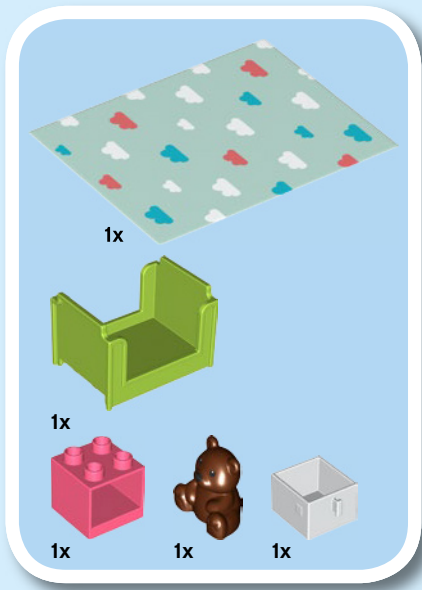

19

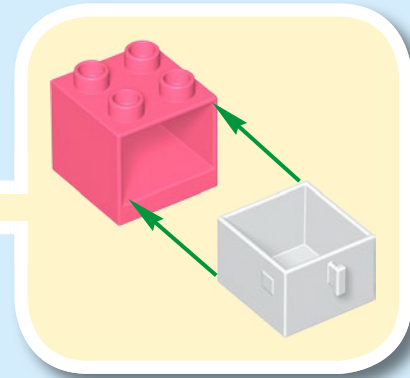

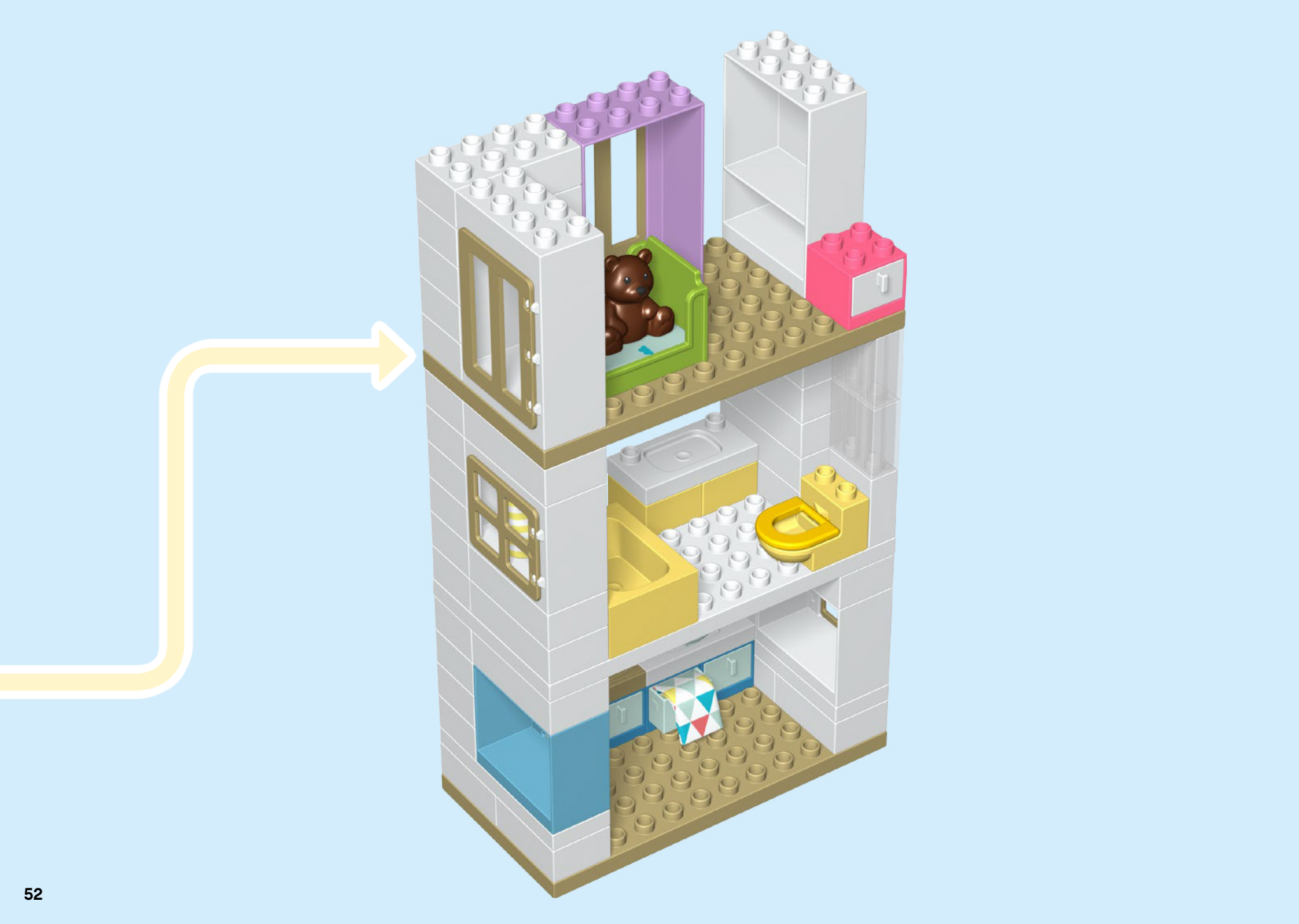

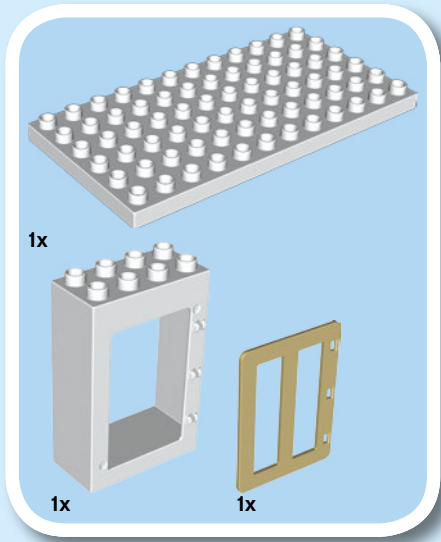

20

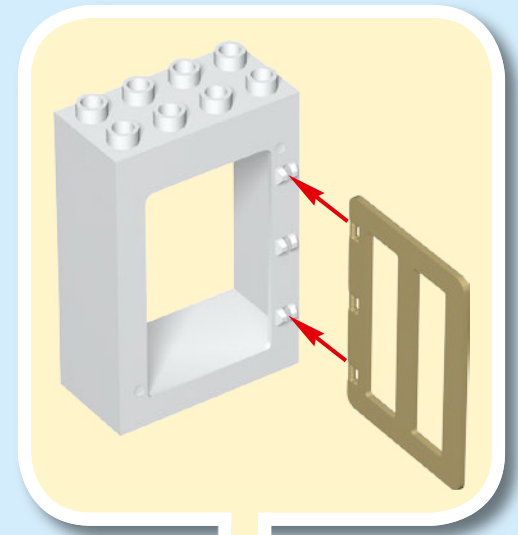
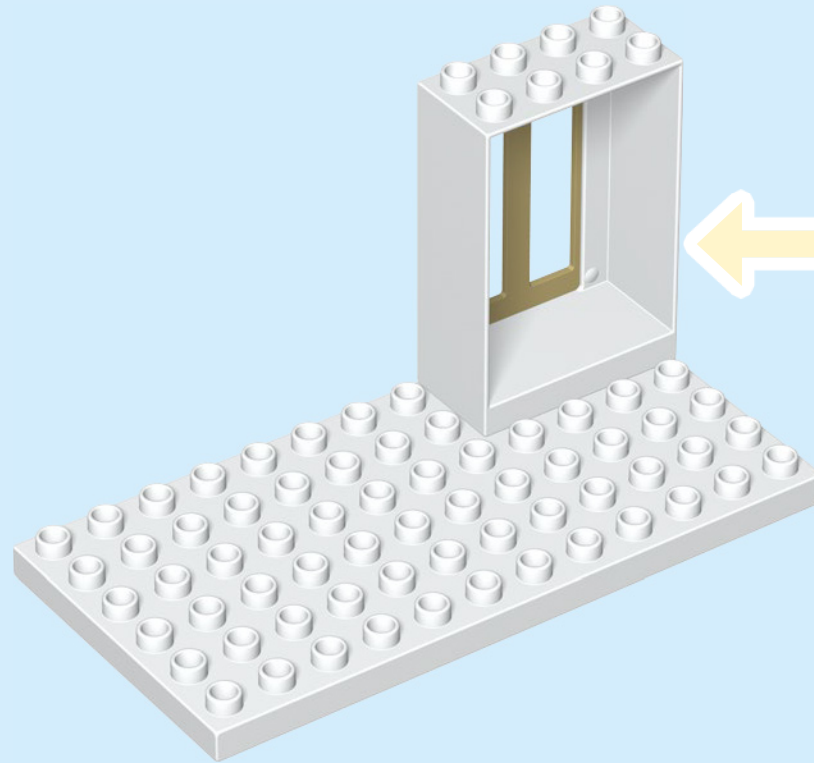

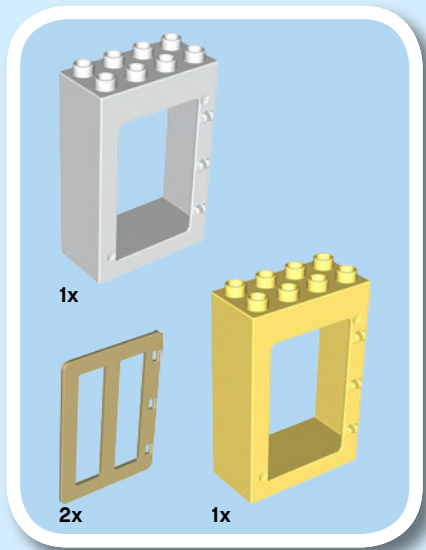

21

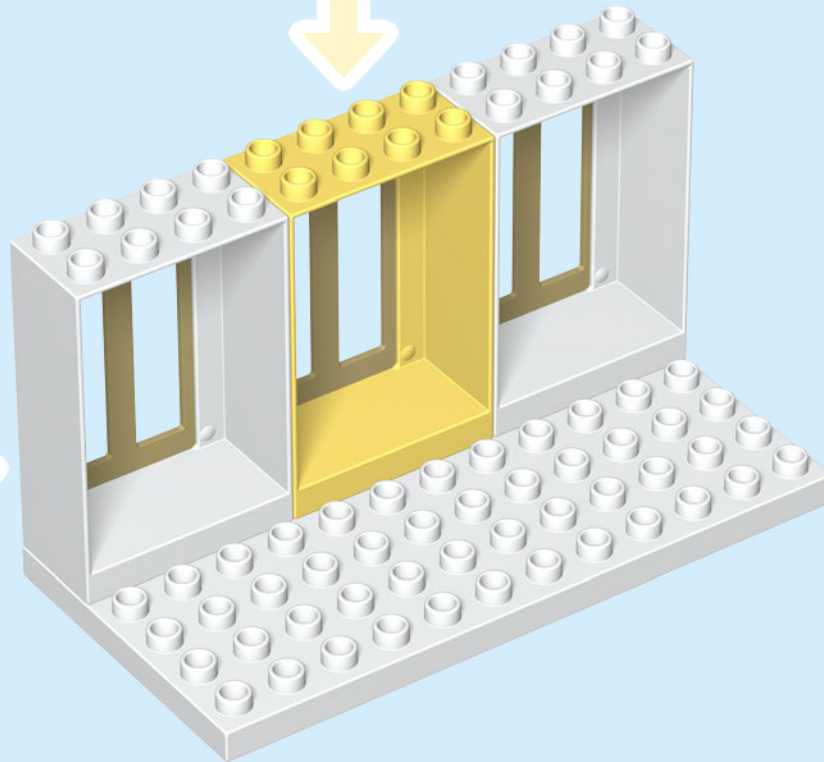
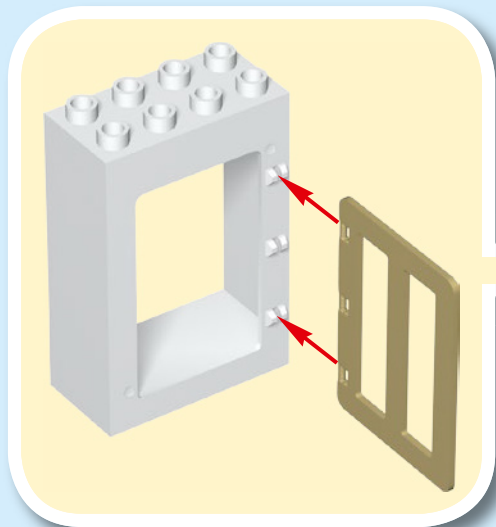
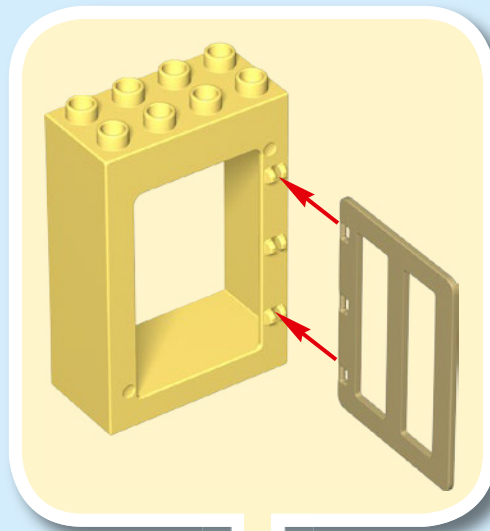

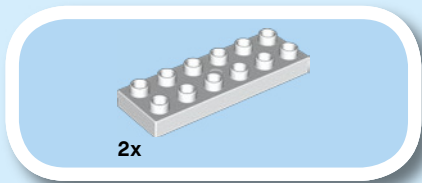

22

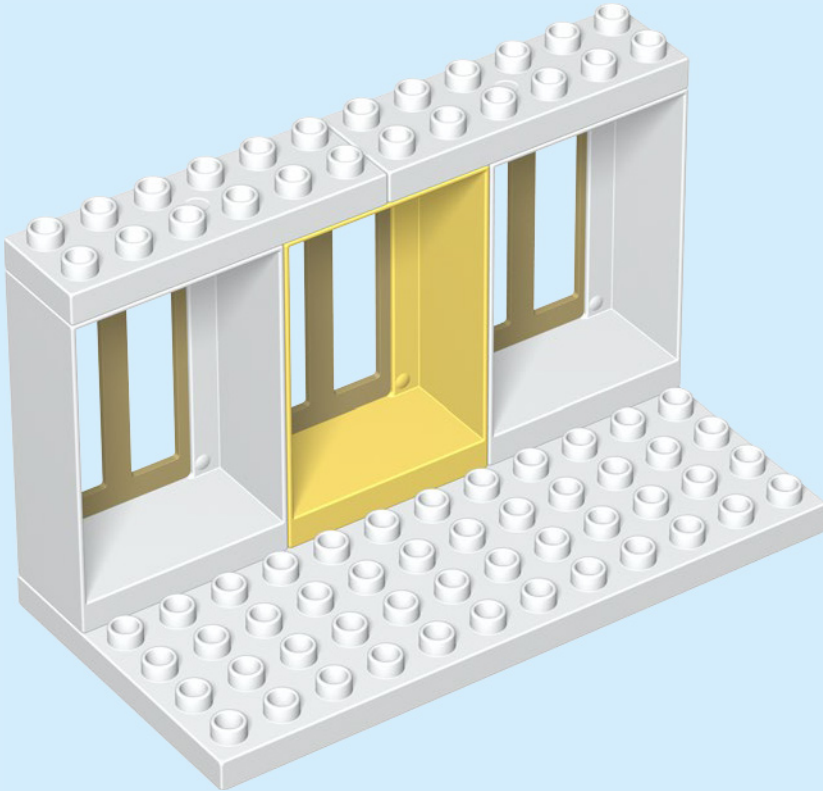

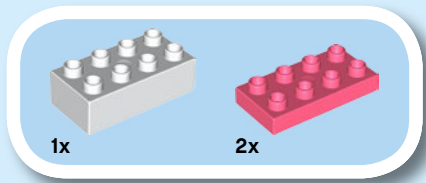

23

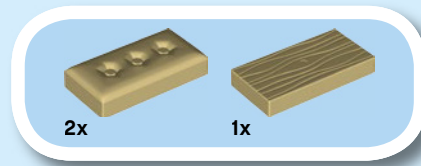
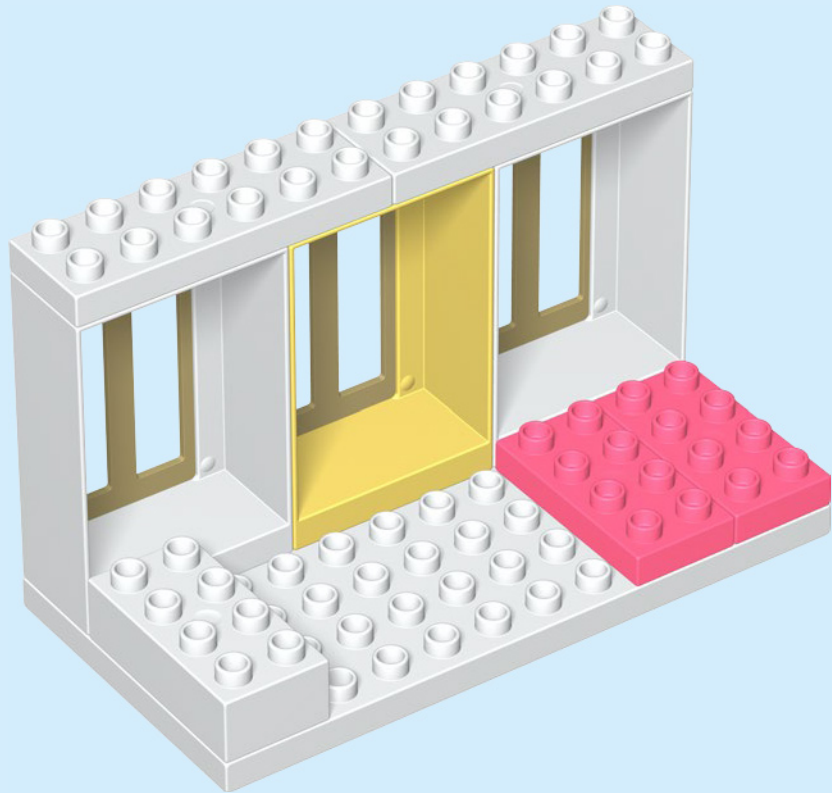

24

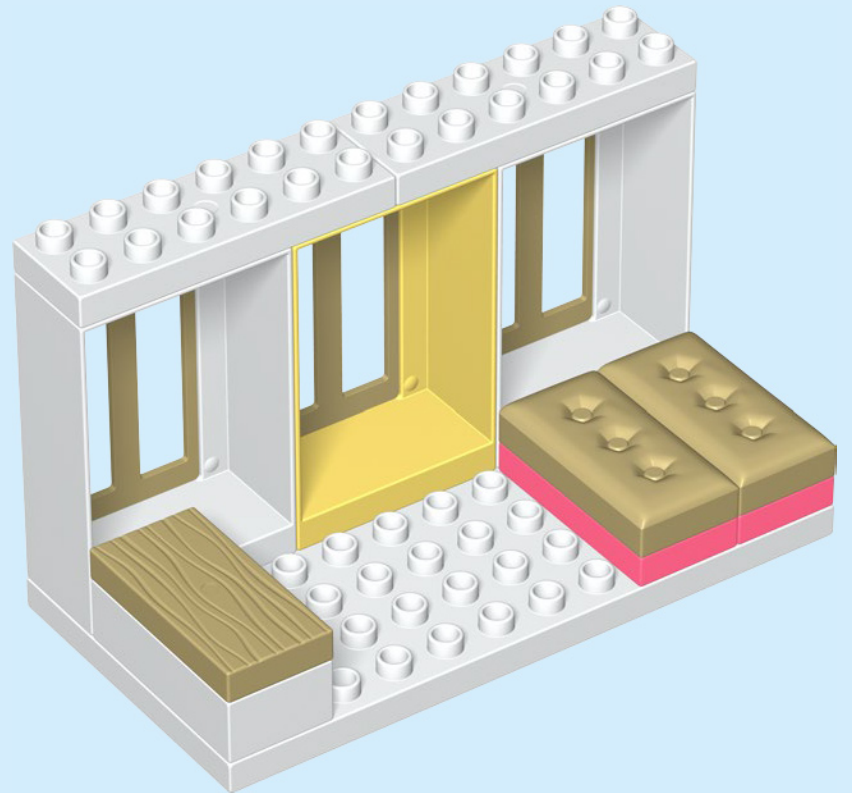

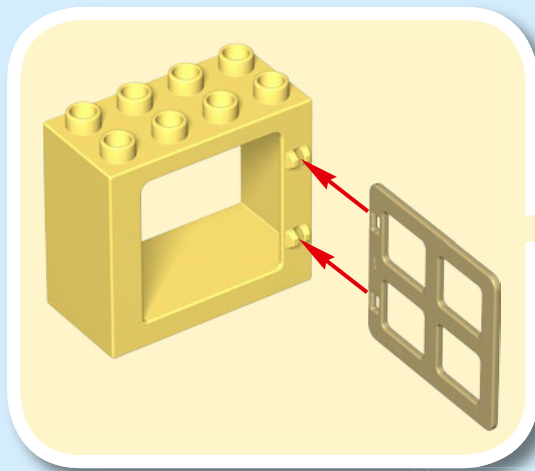
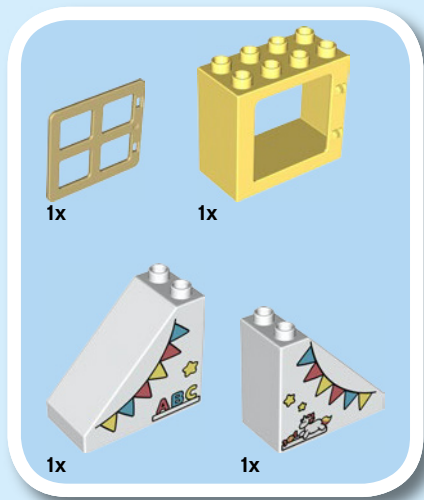

25



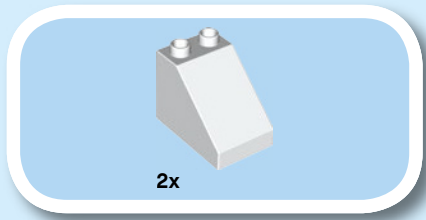

26



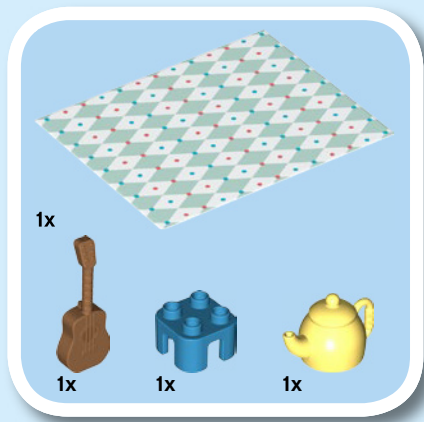

27



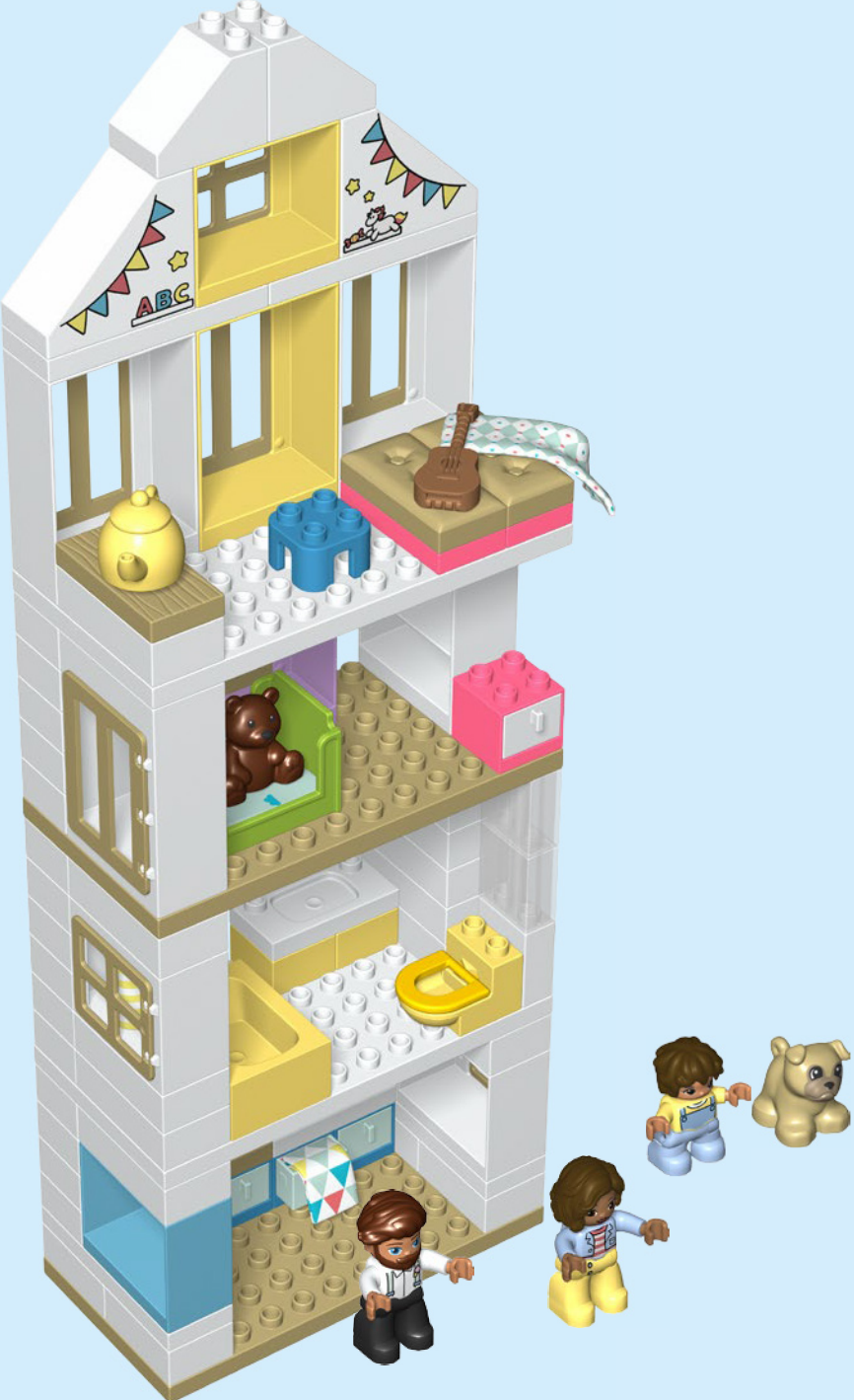
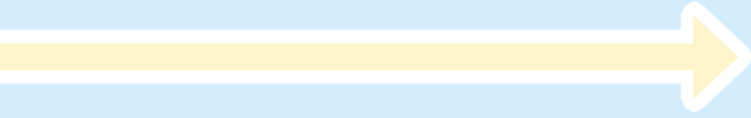

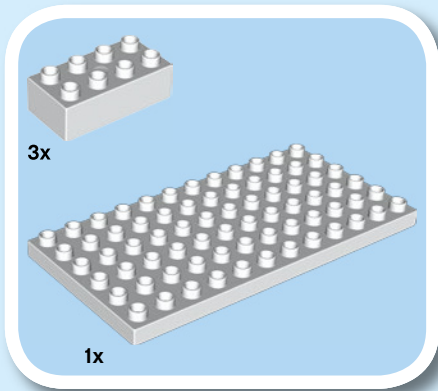

1

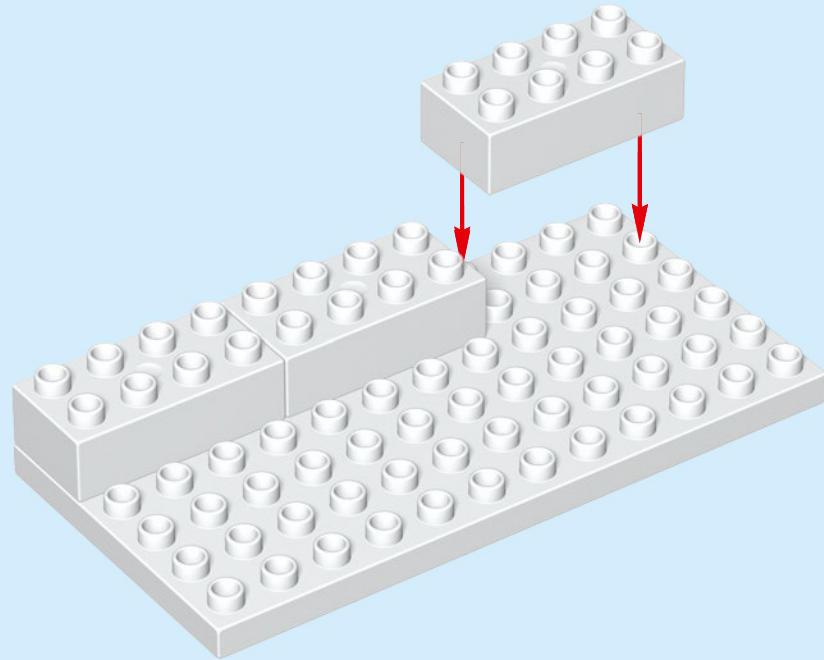

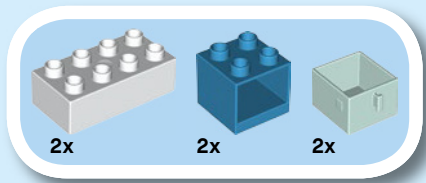

2

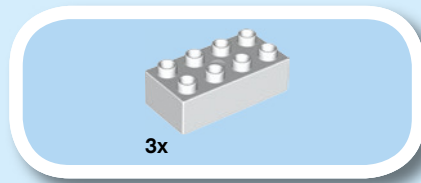
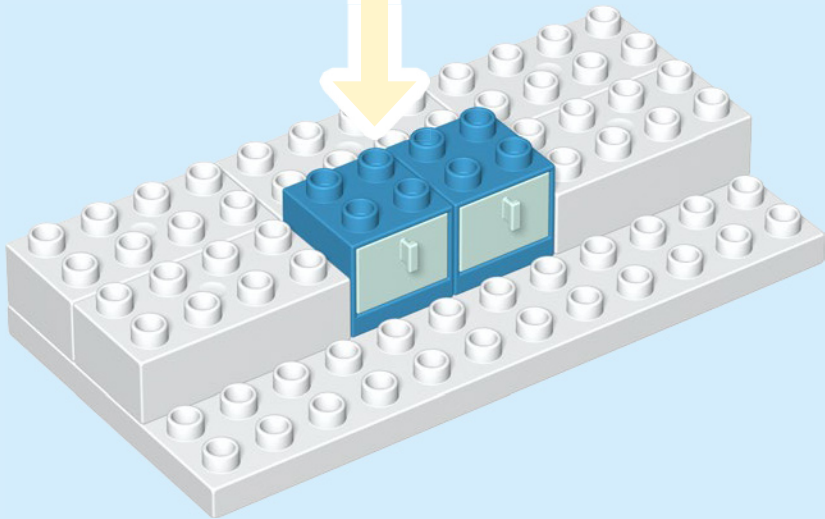
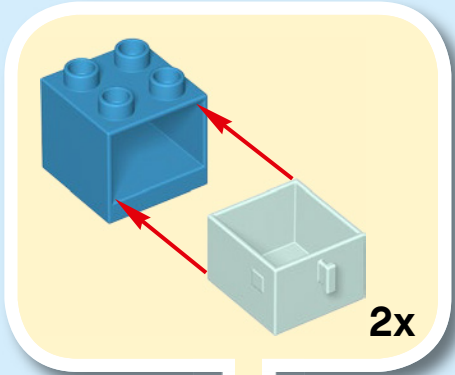

3

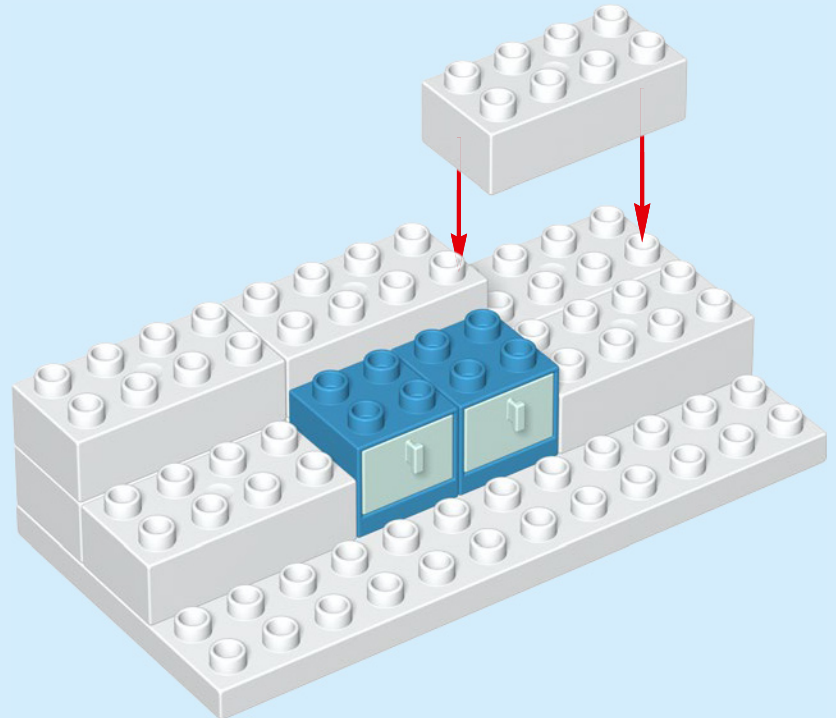

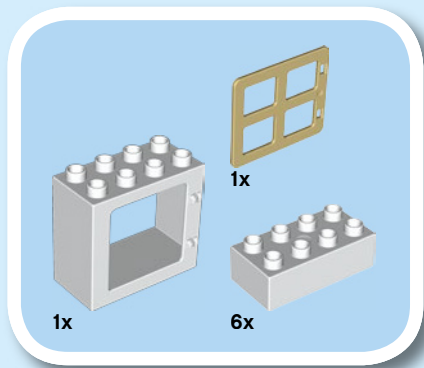

4

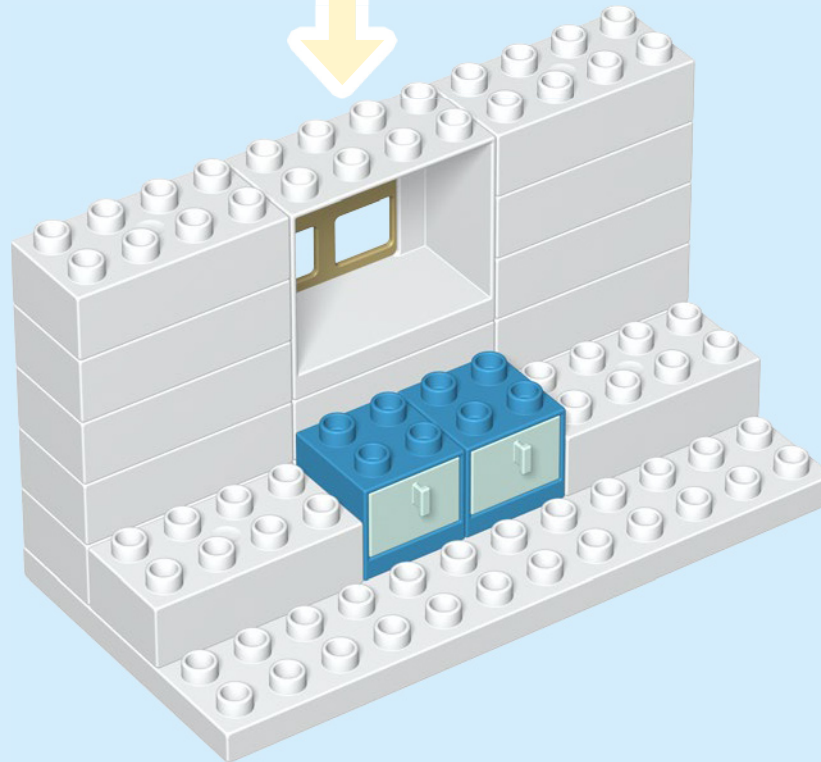
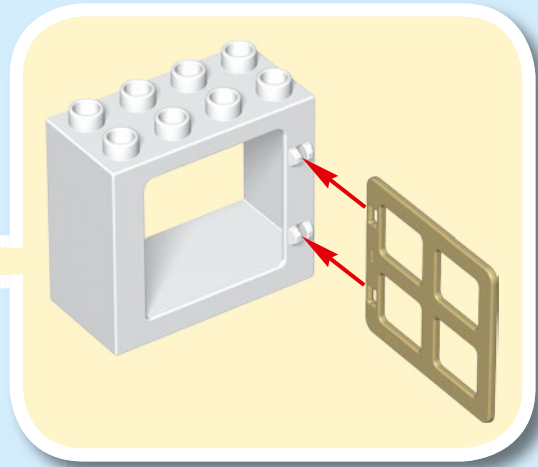

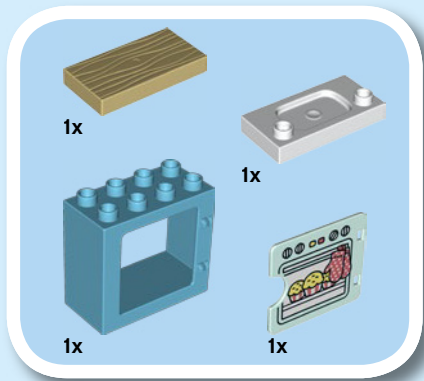

5

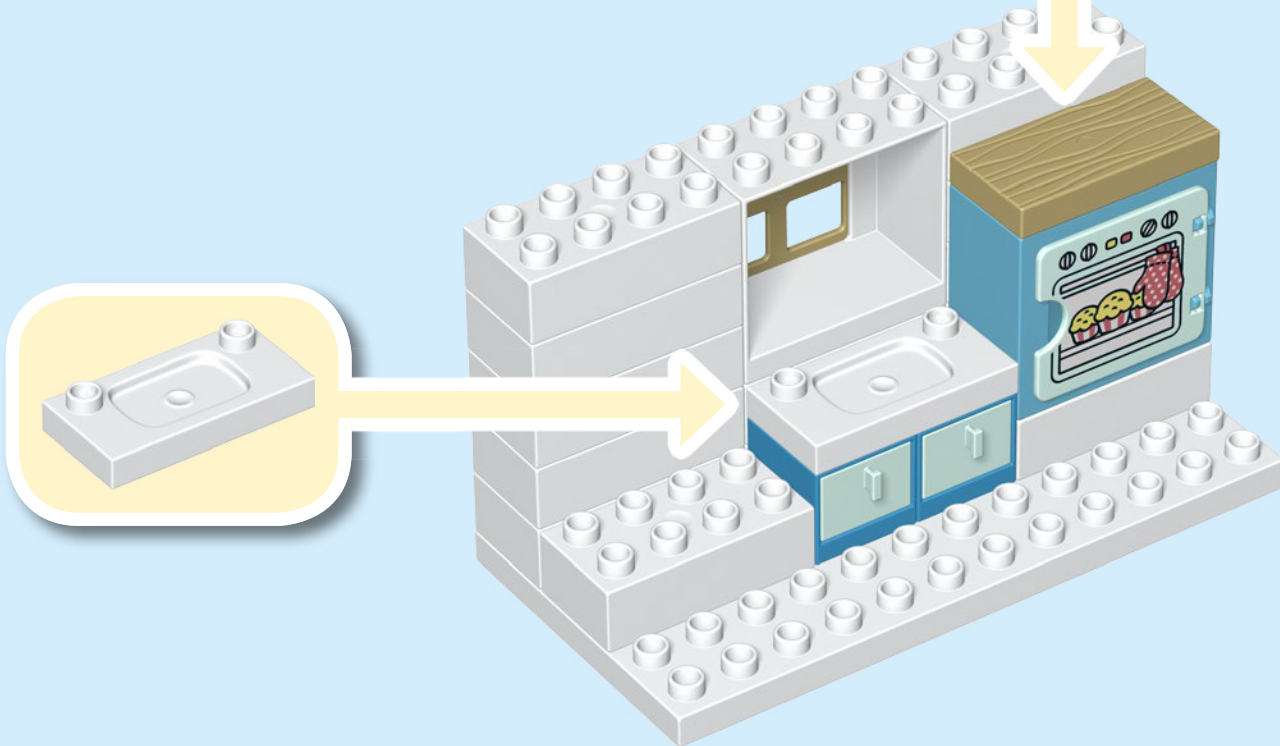
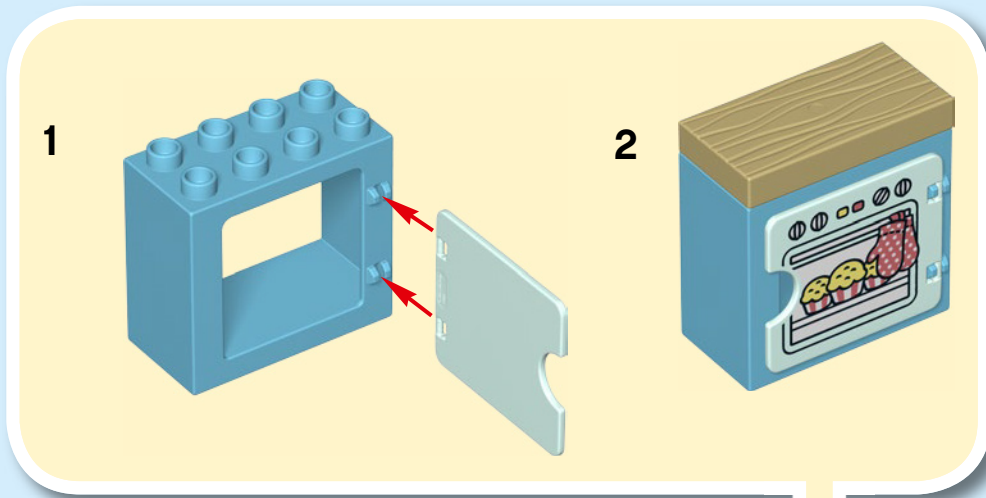

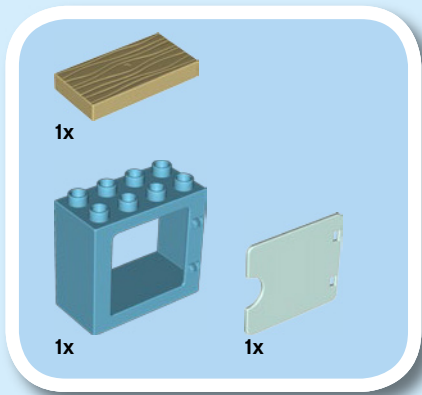

6

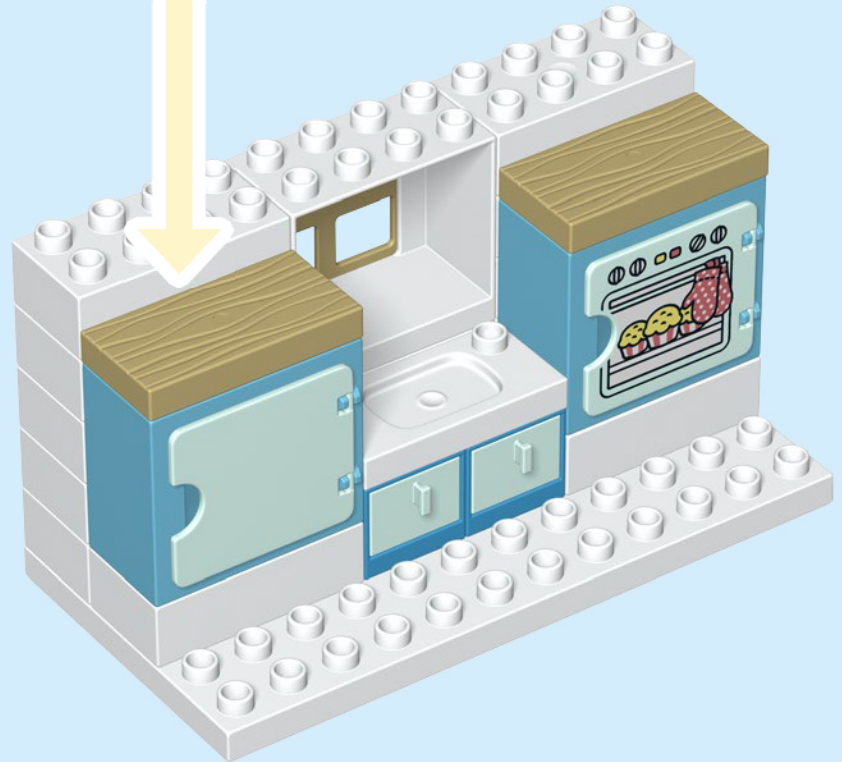
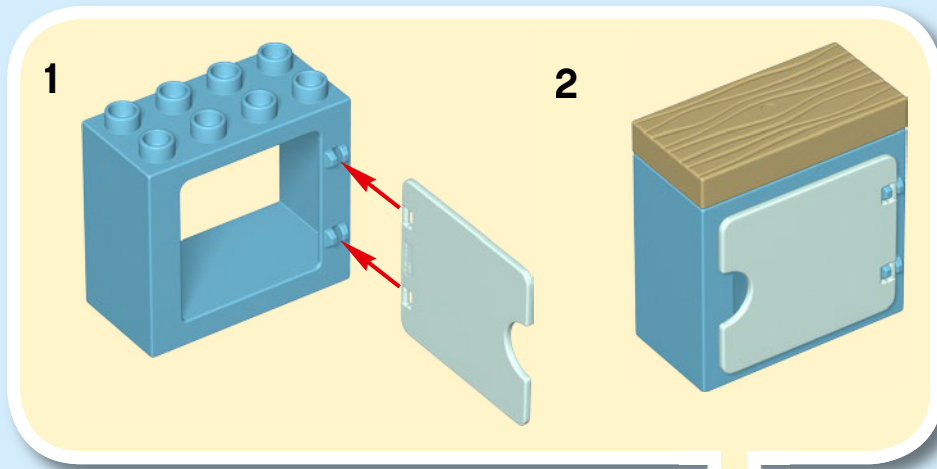

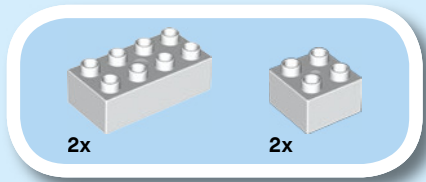

7

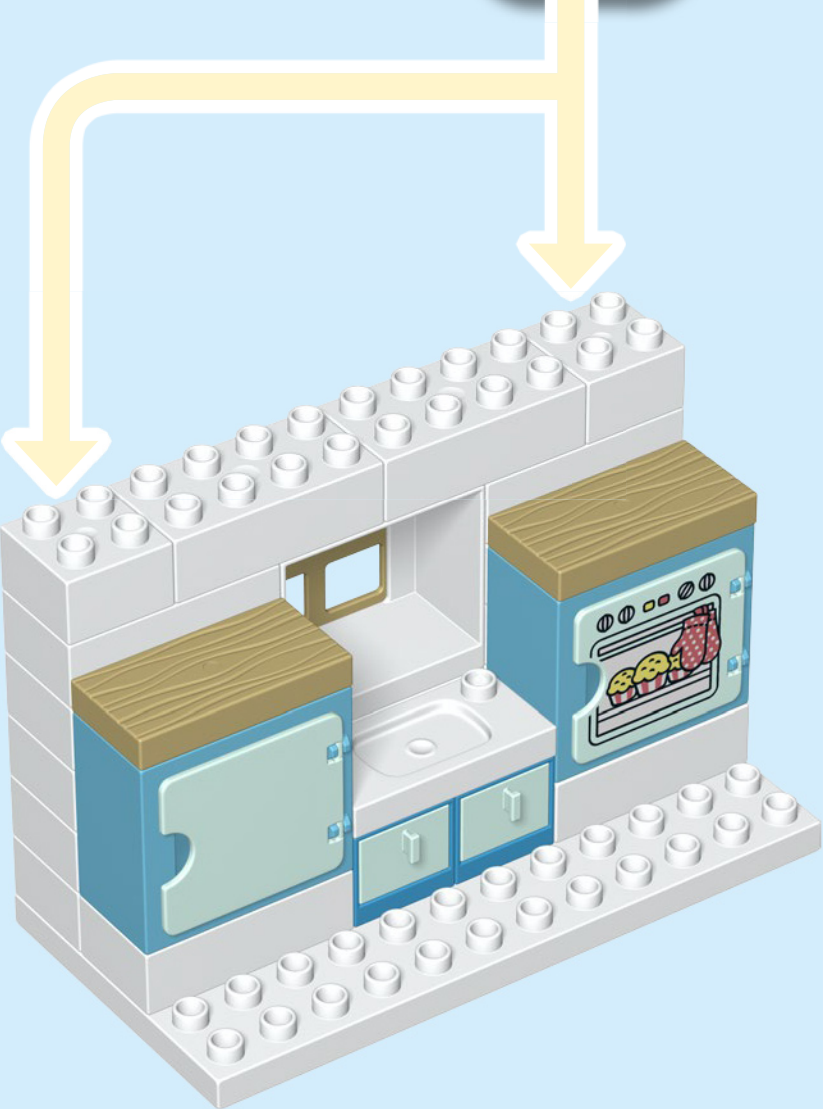
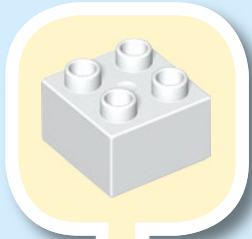

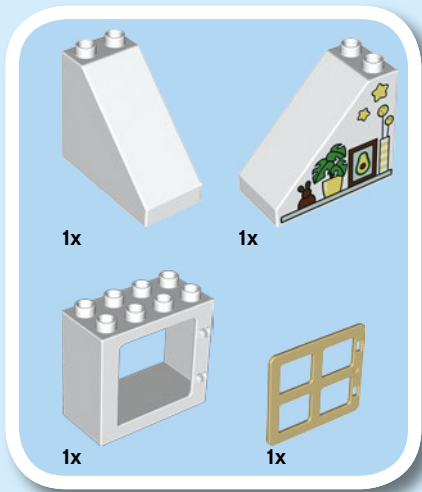

8

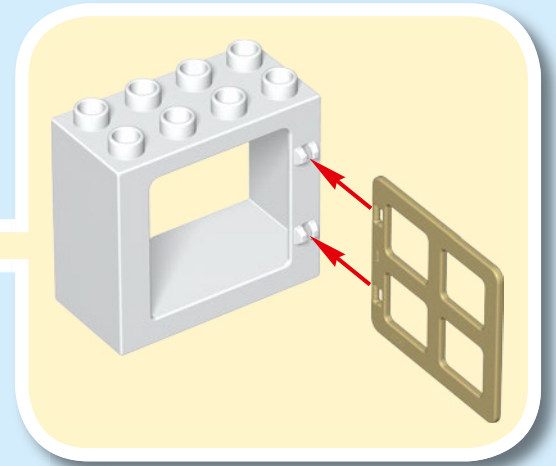

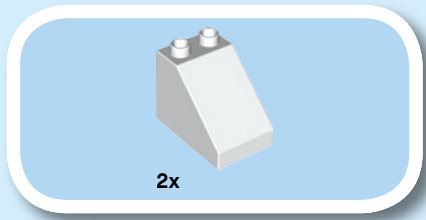

9

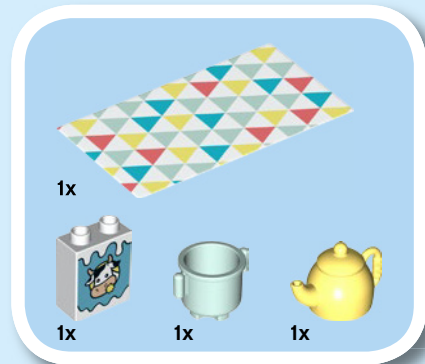

10



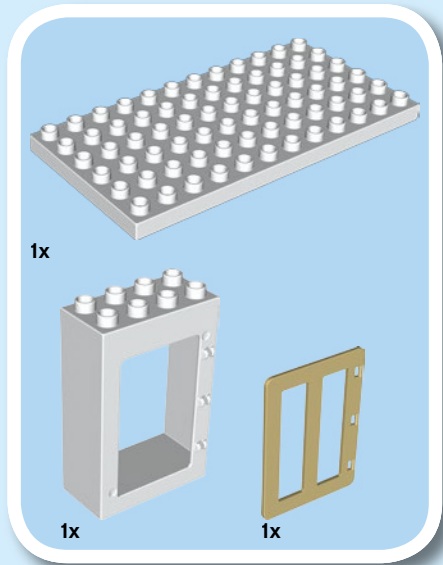
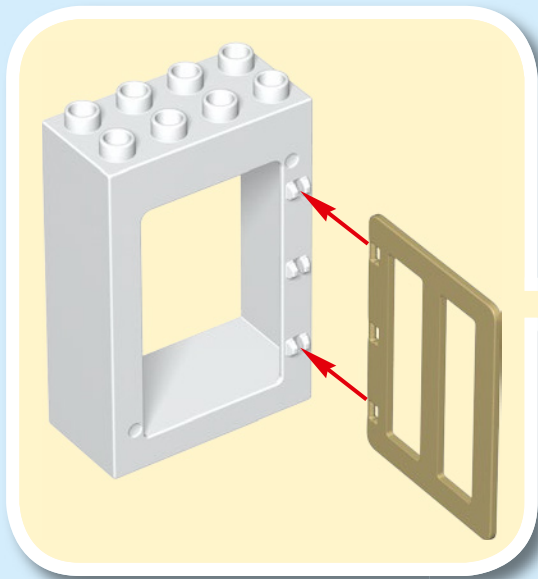

11

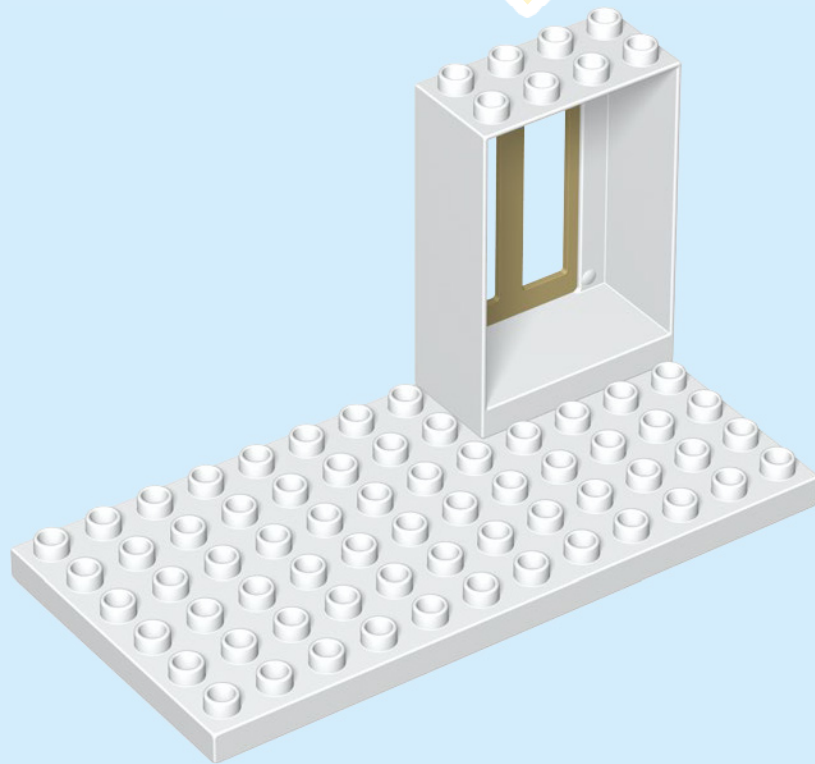

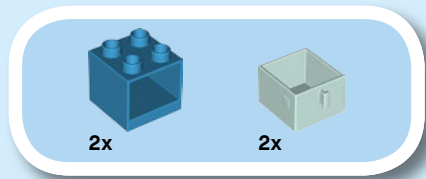

12

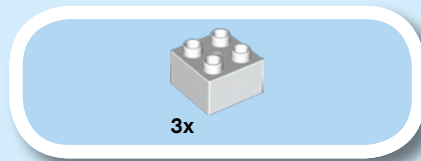
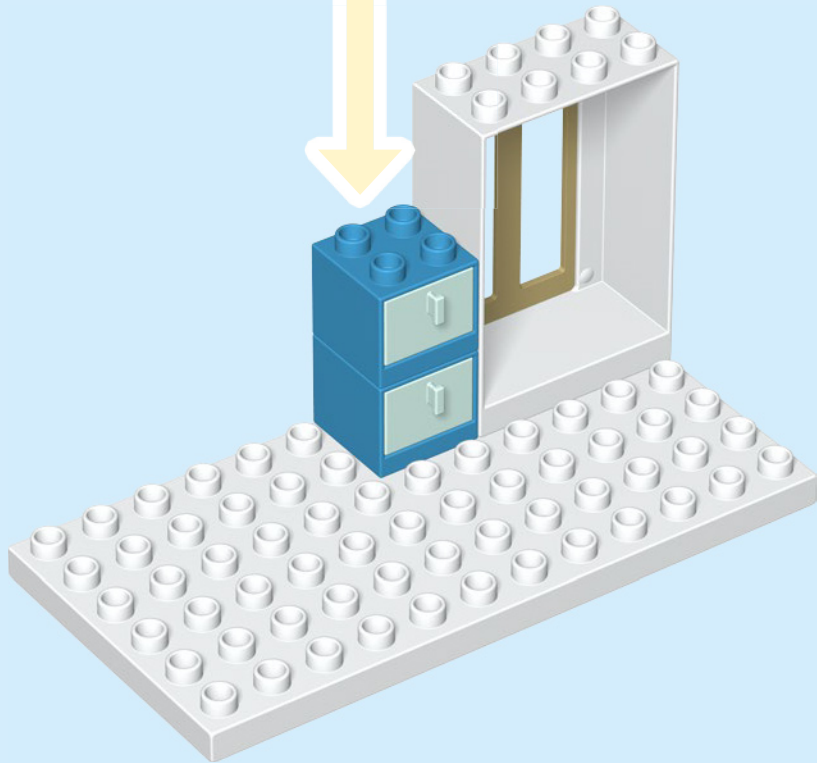
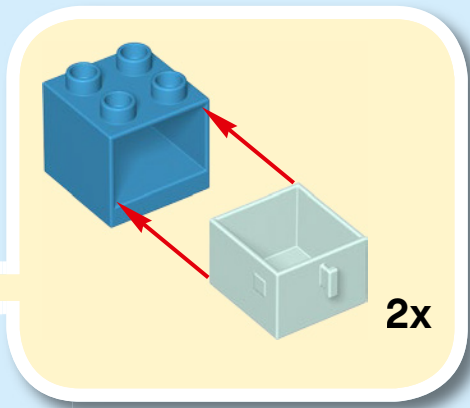

13

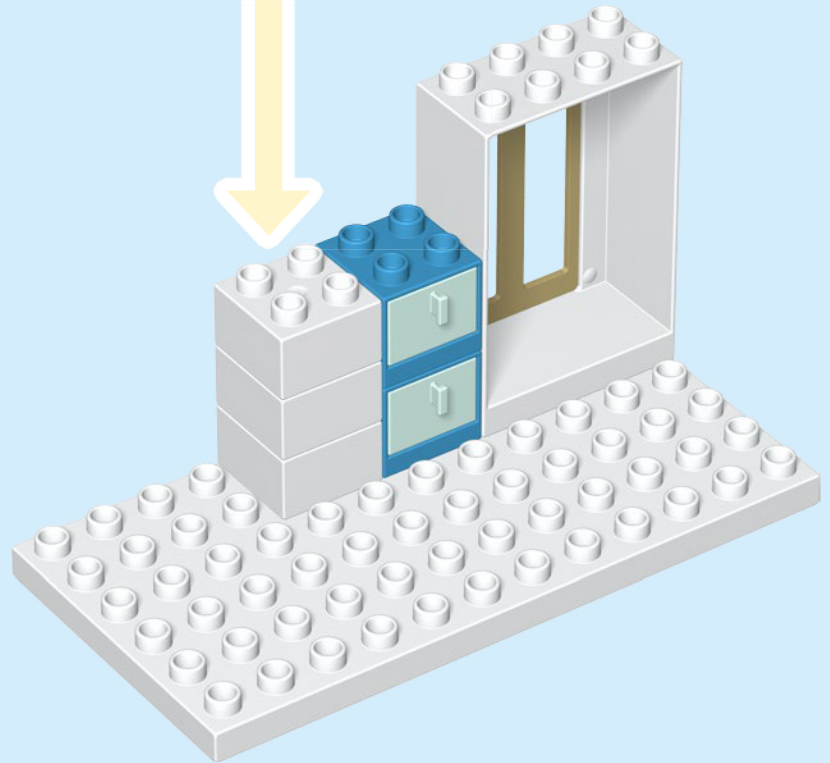
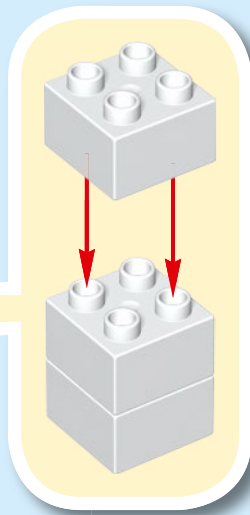

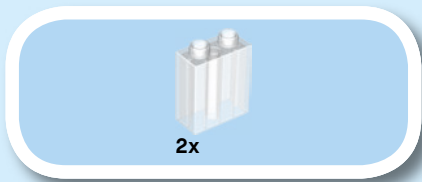

14

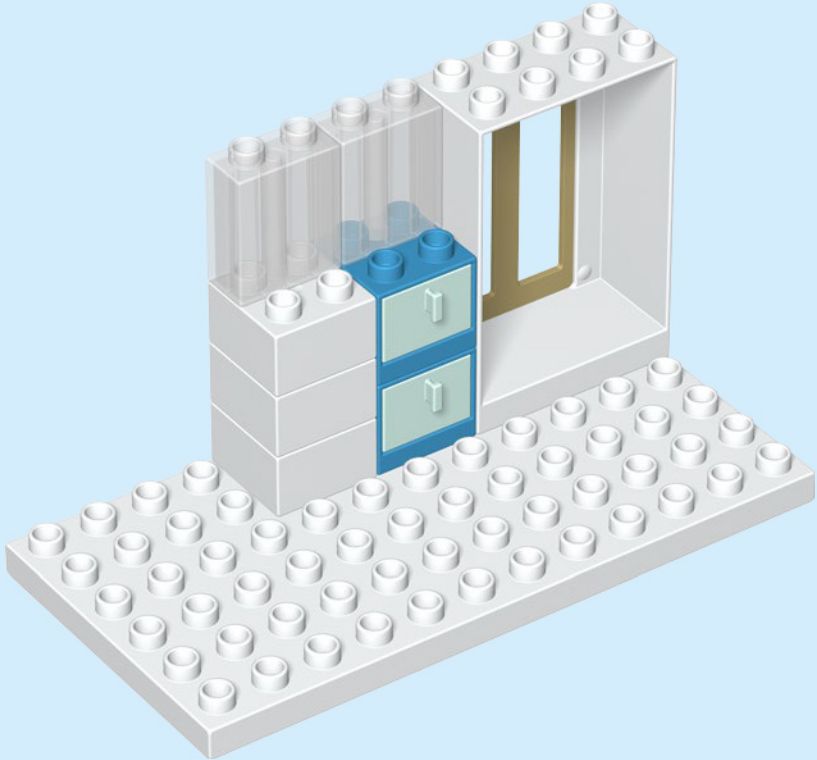

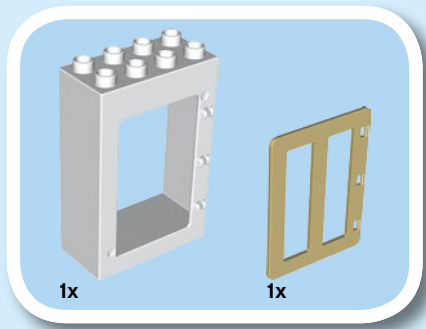

15

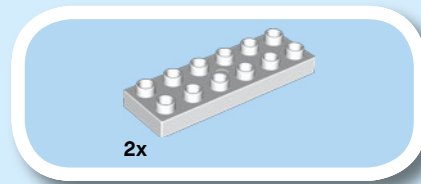
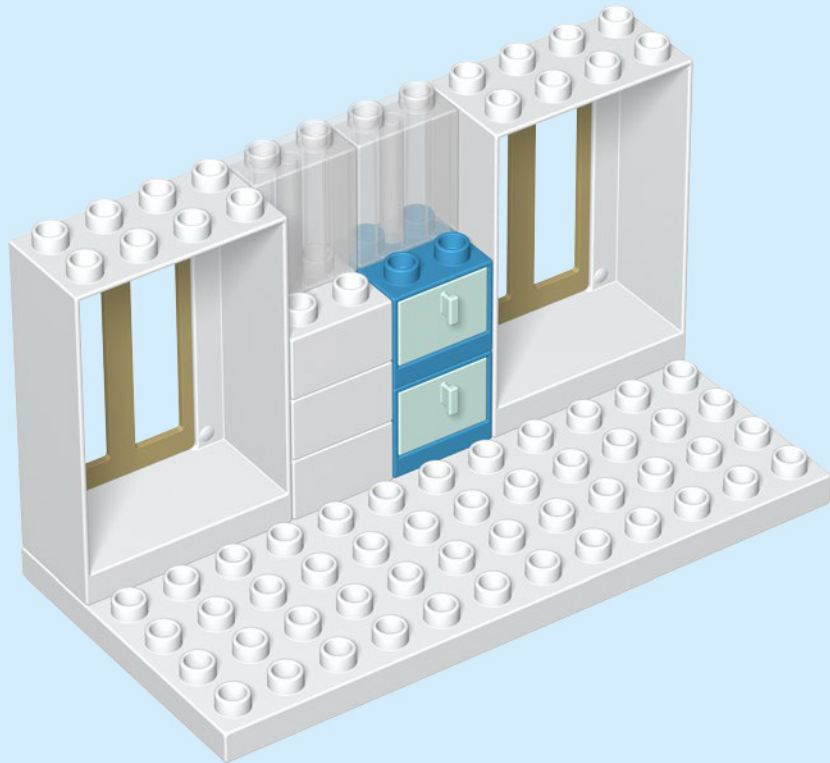

16

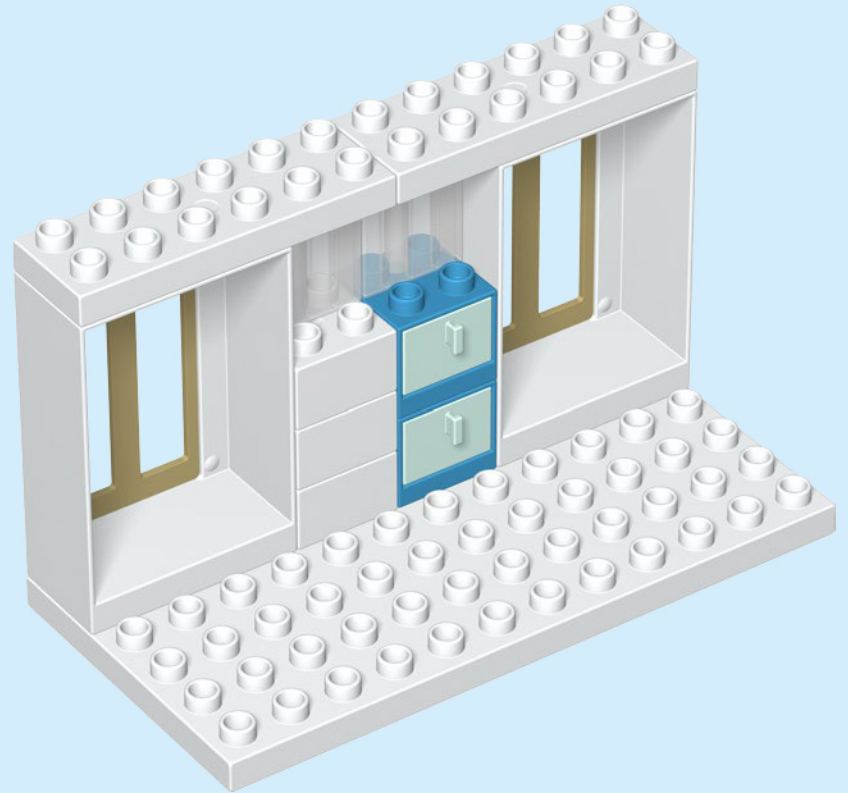

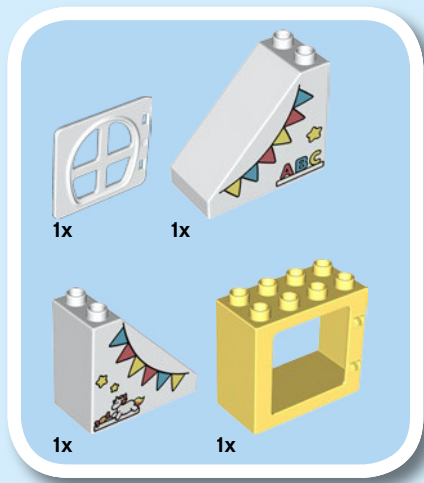

17



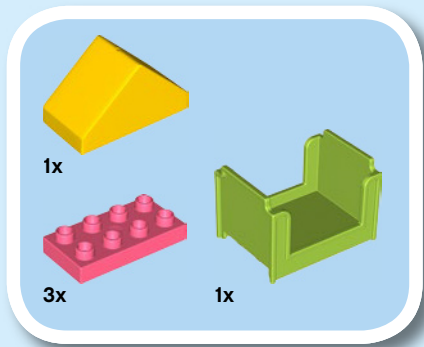

18

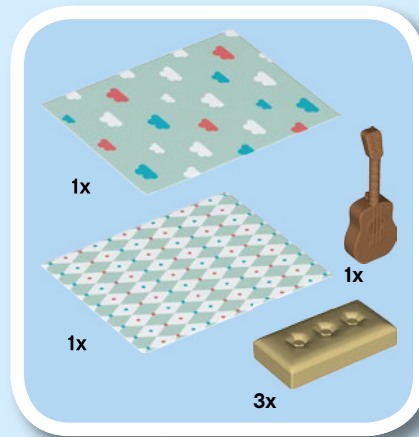

19



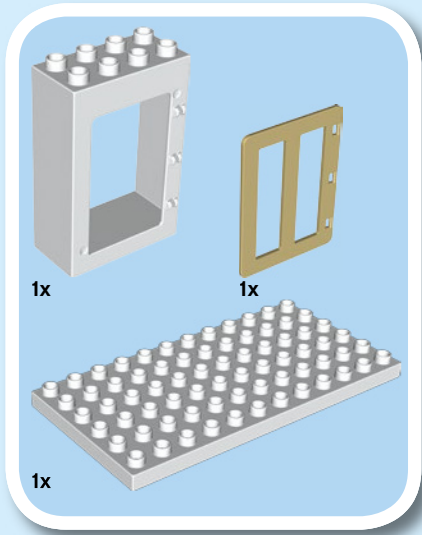
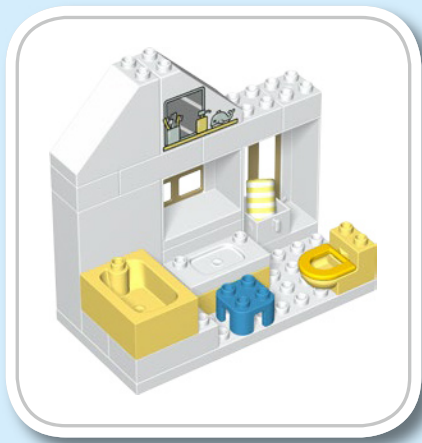

20

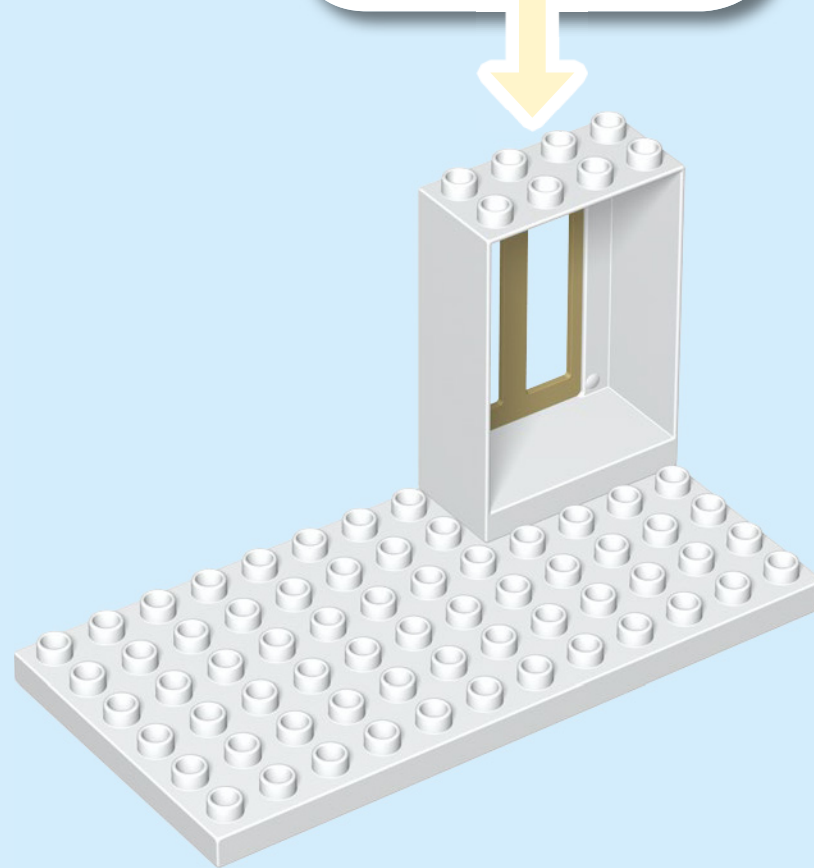
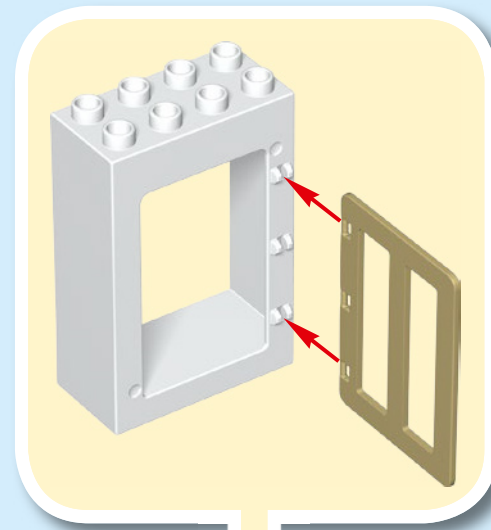

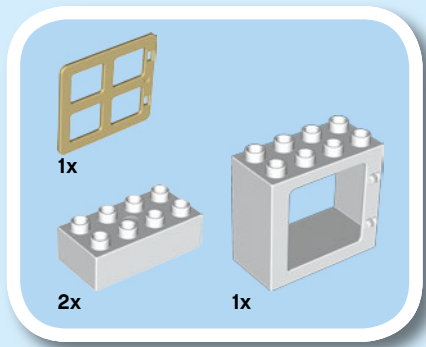

21

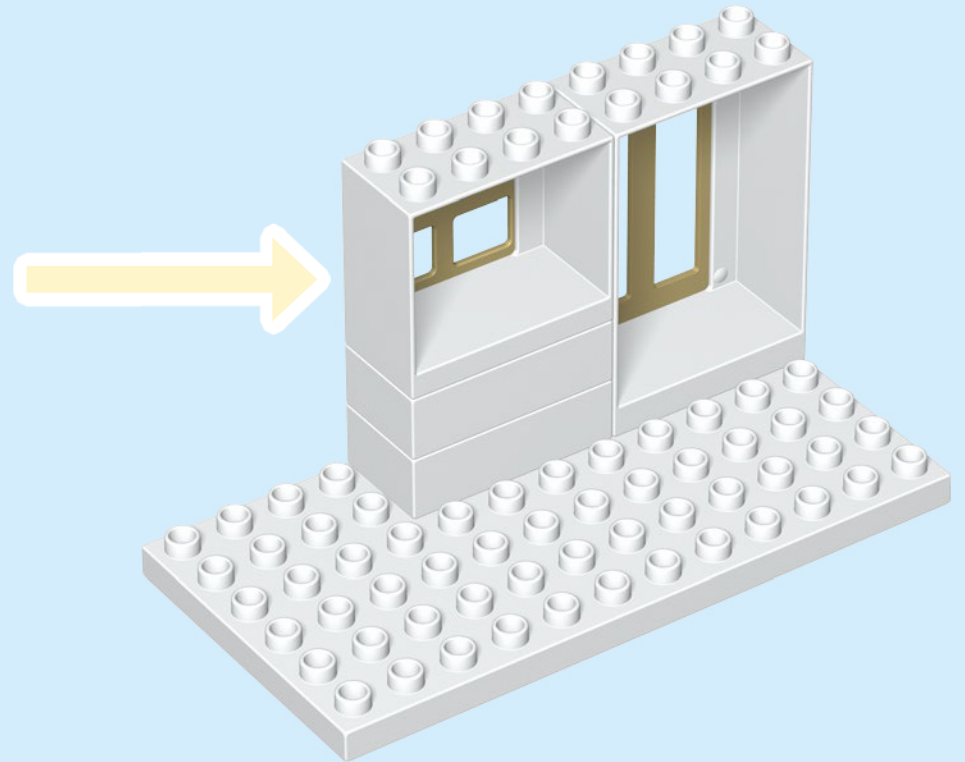
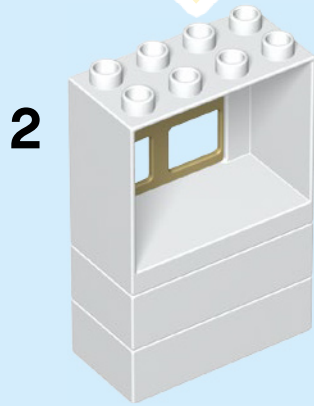
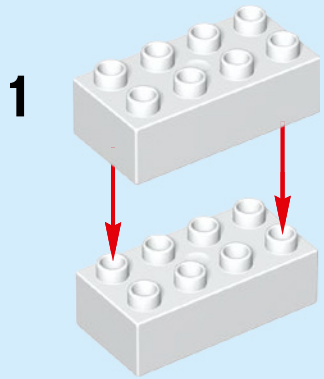
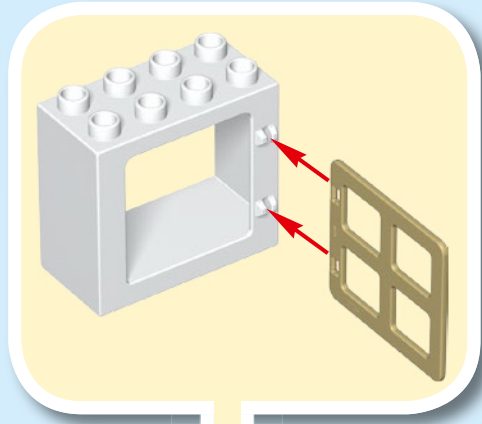

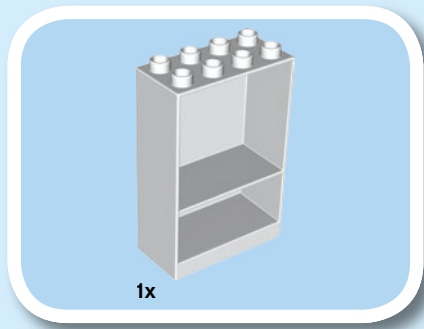

22

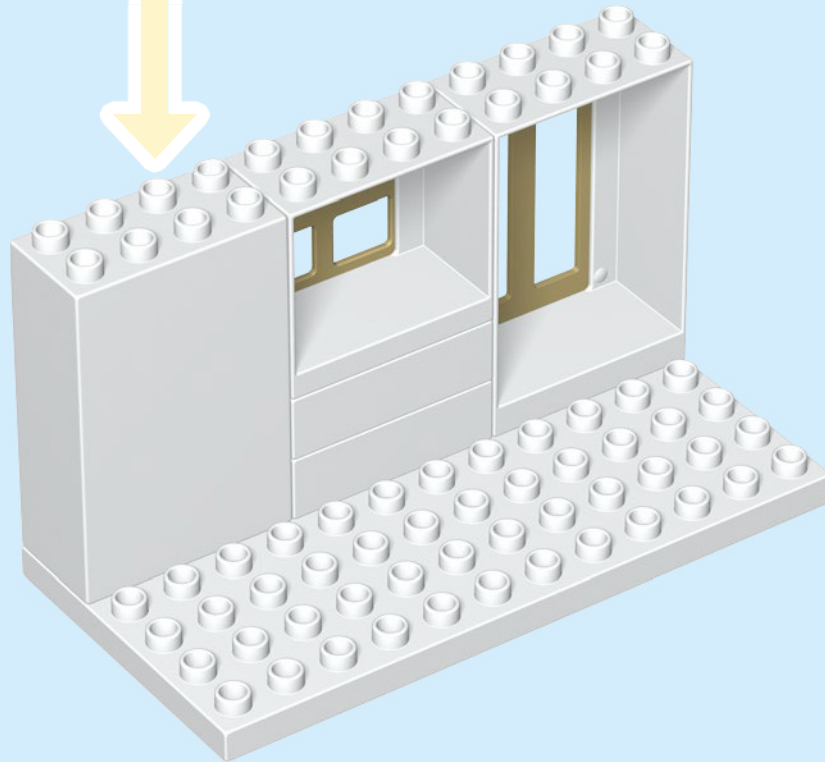

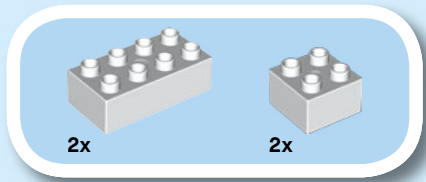

23

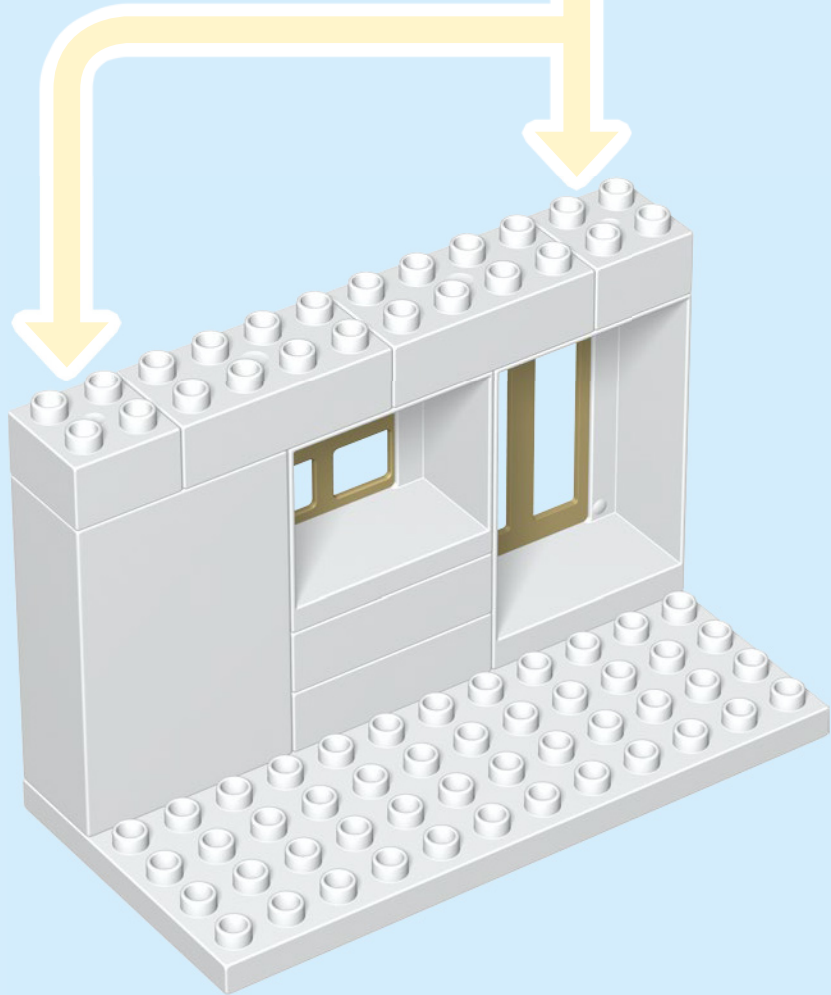
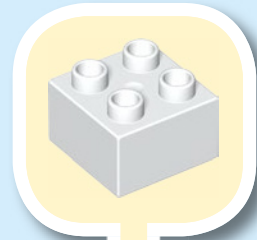

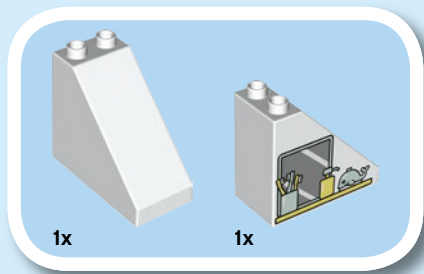

24

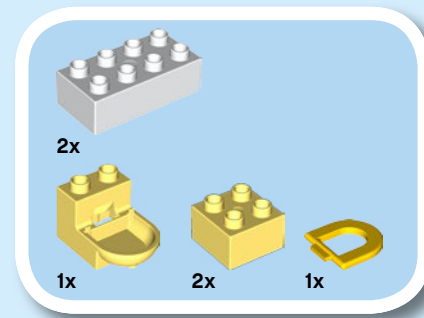
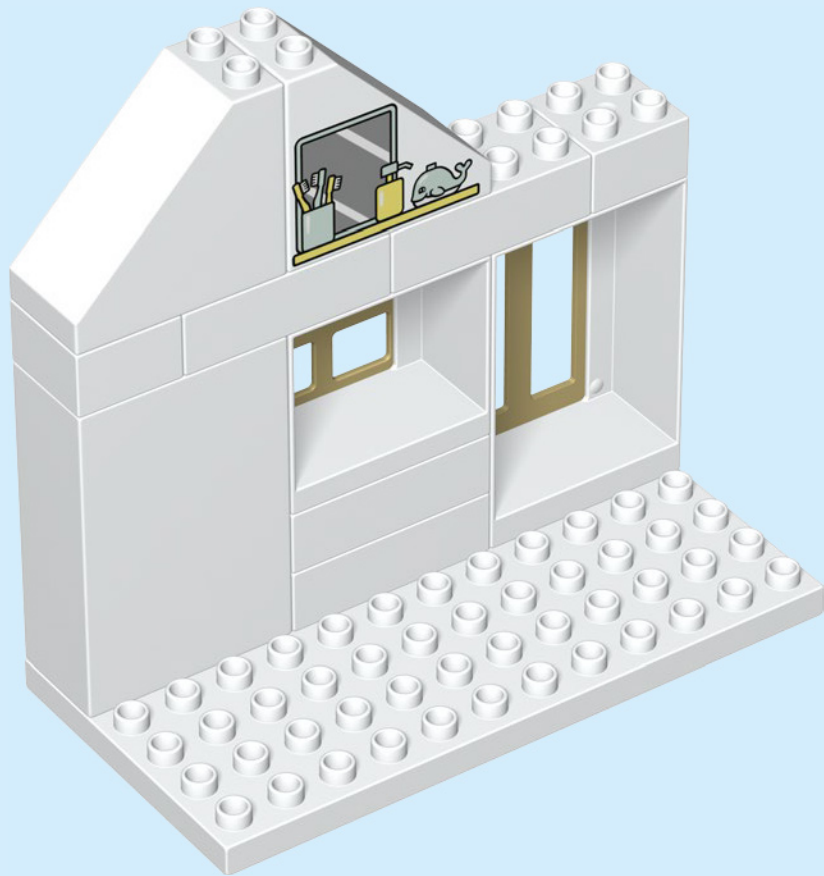

25

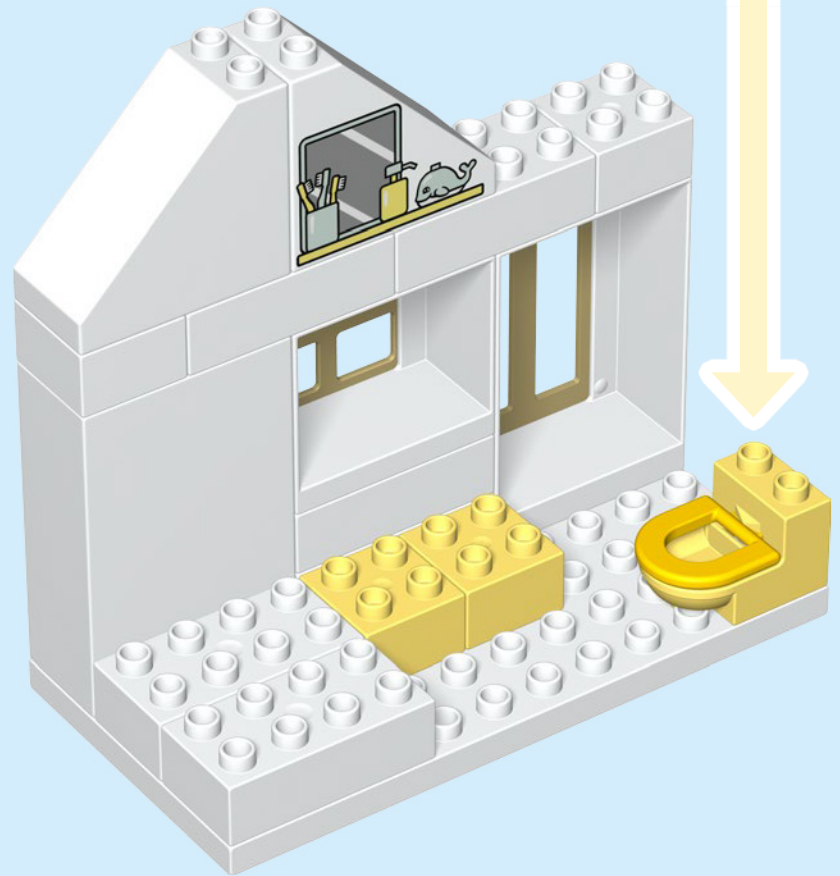

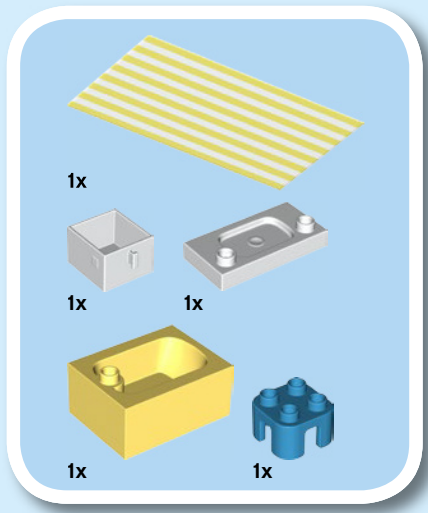

26

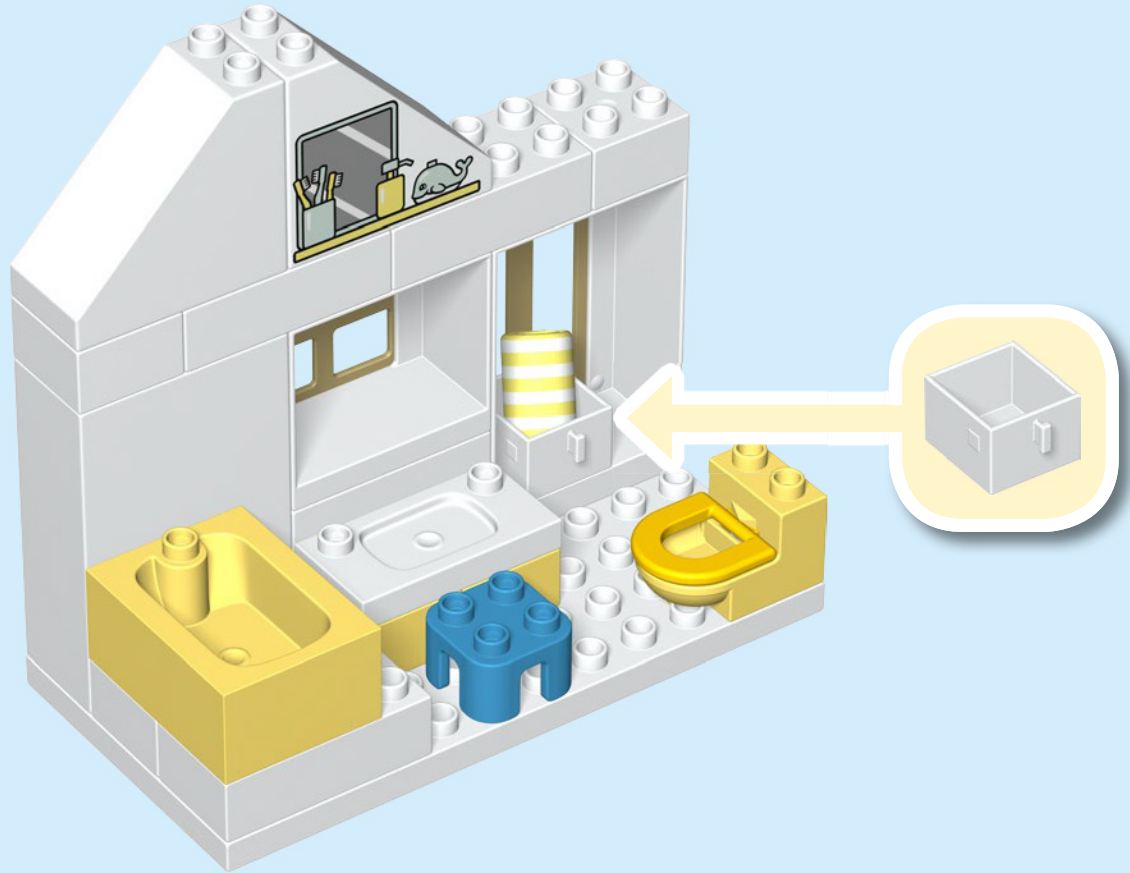





LEGO duplo

Ages/edades

1 1/2



10915
Ages 1 1/2+



2+



10929
Ages 2+

EXTRA
IDEAS
INCLUDED

D'AUTRES
IDÉES
INCLUSES

INCLUYE
IDEAS
EXTRA



10913
Ages 1 1/2+

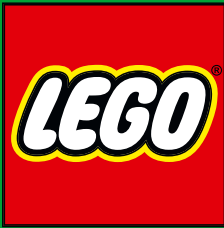

duplo

A WORLD OF LEGO® DUPLO®

LE MONDE DE LEGO® DUPLO®

UN MUNDO DE LEGO® DUPLO®



The availability of apps is subject to the local strategies of the LEGO Group.

La disponibilité des applications est soumise aux stratégies locales du Groupe LEGO.

La disponibilidad de las apps está sujeta a las estrategias regionales de The LEGO Group.

Customer Service
Kundenservice
Service Consommateurs
Servicio Al Consumidor

LEGO.com/service or dial

: 00800 5346 5555

: 1-800-422-5346



Go to www.LEGO.com/productfeedback
win
 and give us your short
feedback about this
 LEGO® DUPLO® set for a chance to win
 a cool LEGO prize

Terms & Conditions apply

LEGO.com/productfeedback

GEWINNE

Erzähle uns auf www.LEGO.com/productfeedback

etwas über die Erfahrungen, die du mit diesem LEGO® Set gemacht hast, und sichere dir die Chance auf einen coolen LEGO Preis!

Es gelten die Teilnahmebedingungen

GAGNE

Rends-toi sur www.LEGO.com/productfeedback

et donne-nous quelques commentaires sur ce produit LEGO® pour avoir une chance de gagner un prix LEGO !

Voir Conditions Générales

GANAN

Visita www.LEGO.com/productfeedback

y envíanos tu opinión acerca de este set LEGO®, ¡Participarás en el sorteo de un premio LEGO!

Términos y Condiciones aplicables

获取奖品

登录 www.LEGO.com/productfeedback

给出关于此乐高®套装的简短反馈，就有机会获得炫酷乐高奖品

《条款及条件》适用

경품 당첨 기회

www.LEGO.com/productfeedback

페이지로 이동하여 이 레고® 세트에 대한 간단한 피드백을 보내 주시고 멋진 레고 경품을 탈 수 있는 기회도 잡으십시오

약관 적용

ЗАПОЛНИ АНКЕТУ И ПОЛУЧИ ПРИЗ

Перейди по ссылке www.LEGO.com/productfeedback

ответь всего на несколько вопросов об этом наборе LEGO®, и у тебя появится шанс выиграть замечательный приз от компании LEGO.

Применяются Условия и правила участия