





[LEGO.com/sustainable-packaging](https://www.lego.com/sustainable-packaging)



 **FR**
DONNEZ
OU
RECYCLEZ

 OU  OU 
ASSOCIATION MAGASIN DÉCHÈTERIE

Adresses sur quefairedemesdechets.fr

LEGO® VIP

1. SIGN UP
INSCRIVEZ-VOUS
REGÍSTRATE

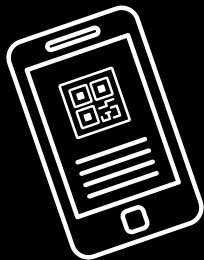

2. EARN POINTS
FOR PURCHASES
GAGNEZ DES
POINTS POUR
VOS ACHATS
GANA PUNTOS
POR TUS COMPRAS



3. REDEEM POINTS FOR REWARDS,
EXPERIENCES, DISCOUNTS & MORE
ÉCHANGEZ DES POINTS CONTRE DES
RÉCOMPENSES, DES EXPÉRIENCES,
DES RÉDUCTIONS ET PLUS ENCORE
CANJEA PUNTOS POR RECOMPENSAS,
EXPERIENCIAS, DESCUENTOS Y
MUCHO MÁS

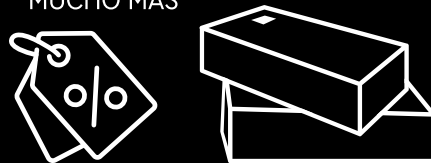

LEGOLAND®





培养你的创造力

“这些不起眼但数量众多的花盆是我们乐高®花植系列的最新成员——三组标志性的异域植物，它们经过微缩化处理，可为你的家带来经典的乐高风。这些生机勃勃的植物既有喜欢潮湿的室内植物，也有来自沙漠的多肉植物和奇特的食虫植物，它们既可以组合在一起，也可以分为三个小组，还能够保持全年常新、乐趣不减。借助精心设计的说明，你可以轻松邀请朋友或亲人加入，希望你们能够一起体验温室之乐！”

THEO BONNER
乐高®模型设计师





热带植物

热带雨林仅覆盖地球表面的 6% 左右，但它们是近三分之二植物物种的家园，其中包括用于治疗各种疾病的药用植物。温暖潮湿的气候条件使成千上万种鲜花、树木和灌木丛茁壮成长，并为动物和人类提供栖息地和食物。



(*Oxalis triangularis*)

紫叶酢浆草

原产于阿根廷、玻利维亚、巴西、巴拉圭和秘鲁的多年生植物。



(*Crassula ovata*)

玉树花

一种原产于南非和莫桑比克的大型多肉植物。



(*Anthurium andraeanum*)

花烛

原产于哥伦比亚和厄瓜多尔的开花植物。

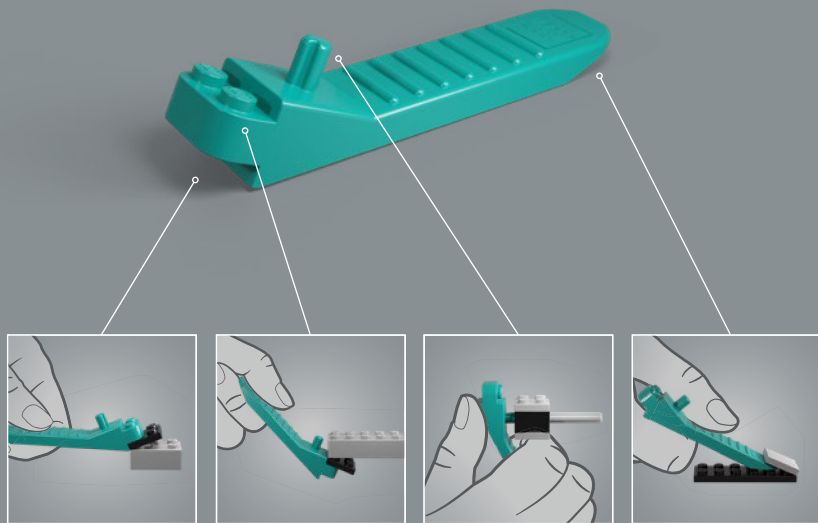



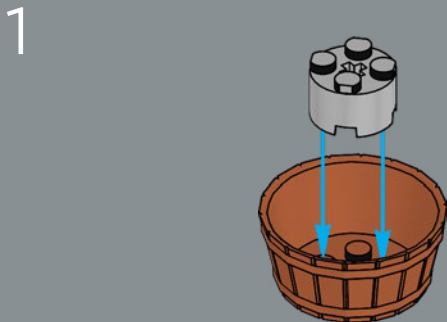
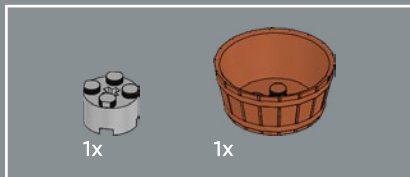

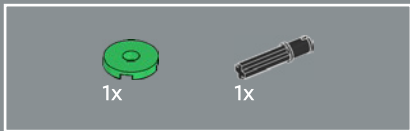

2

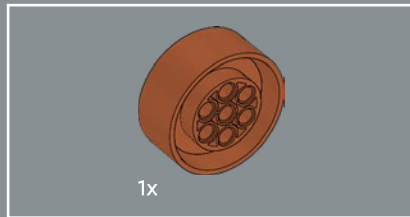
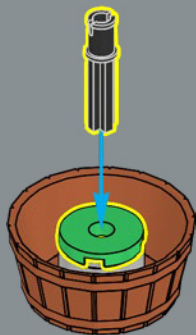

3

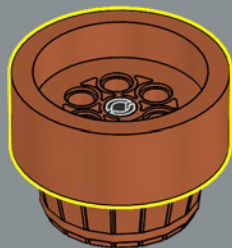



4

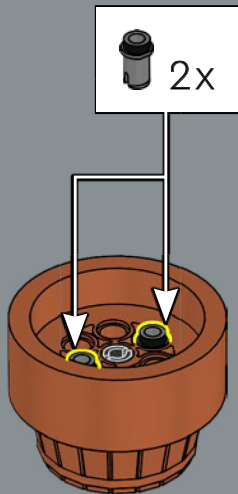

5

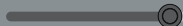

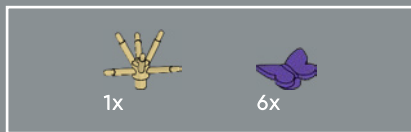

6

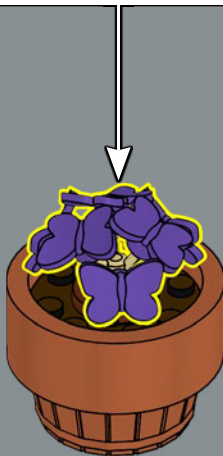
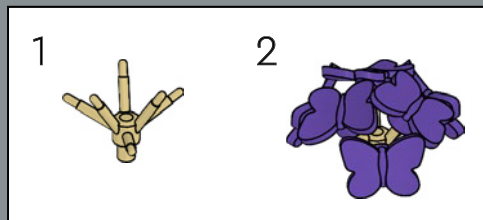

乍一看，紫叶酢浆草可能会被误认为是一大群蝴蝶，所以还有什么能比使用全新颜色的乐高®蝴蝶更好的方式来捕捉这种植物的标志性外观。

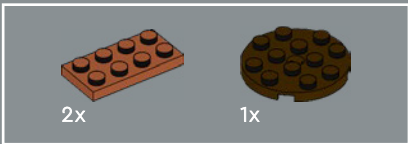
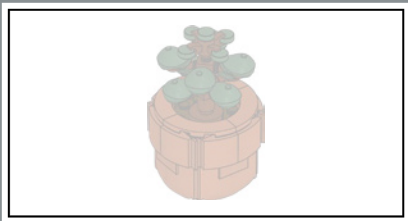

1

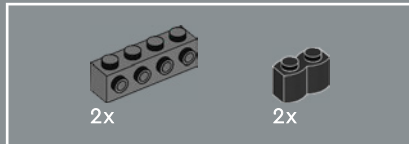
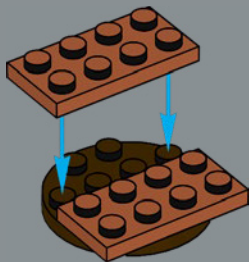

2

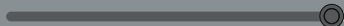
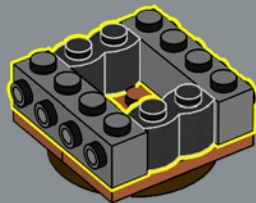

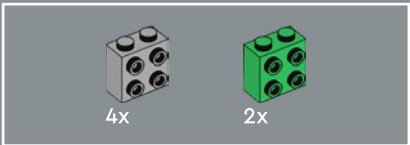

3

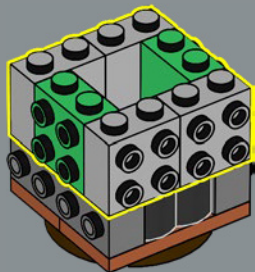

4



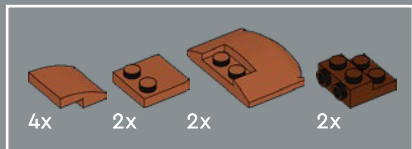

5

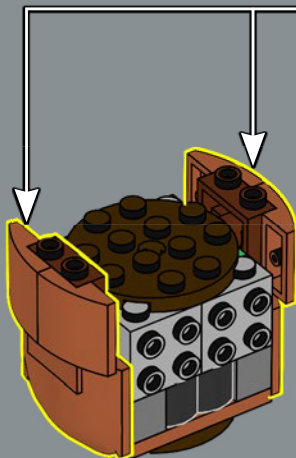
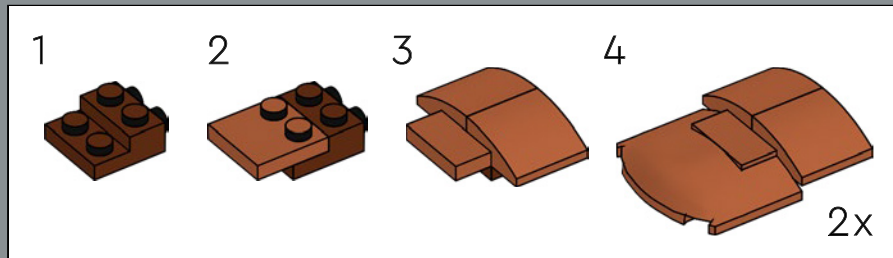

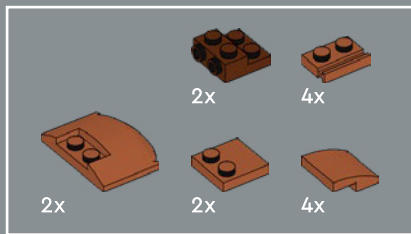

6

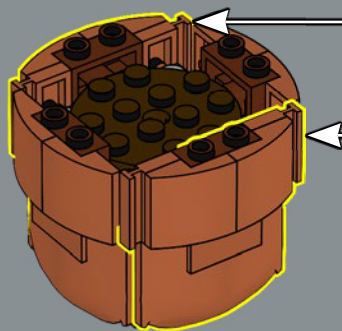
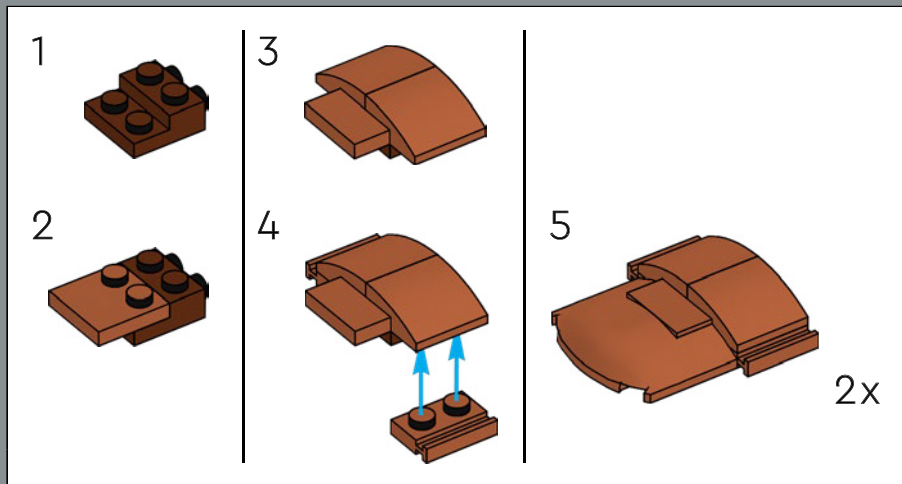

你有没有考虑过学习栽培盆景？玉树花生长迅速，极易成活，还可以根据你的喜好轻松进行修剪。



4x

7

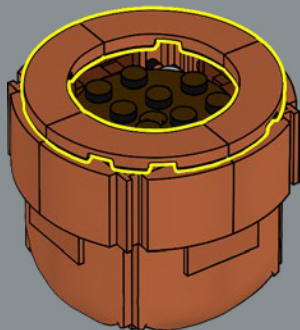



8



9

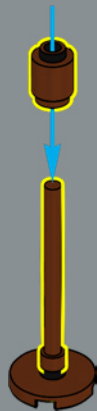



10

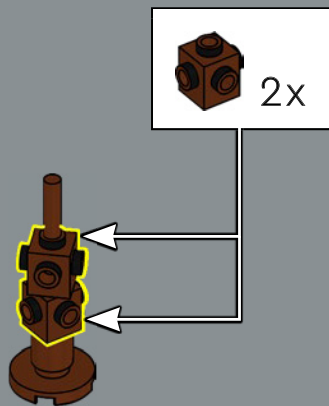

11

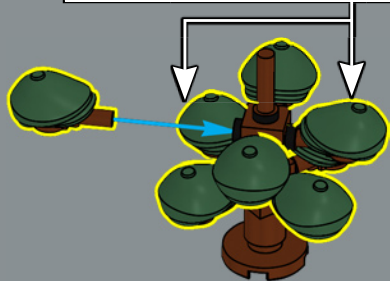
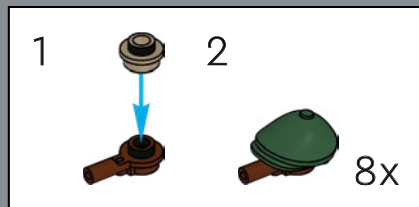

还有! 还有! 继续看! 新颜色的平顶帽! 为了复刻玉树花肥厚的叶子, 我们用了八顶乐高®平顶帽, 这些帽子首次出现在收藏版乐高小人仔小报童中。



12

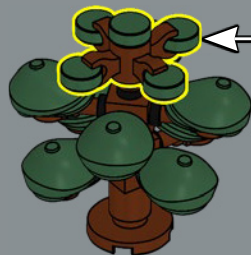

13

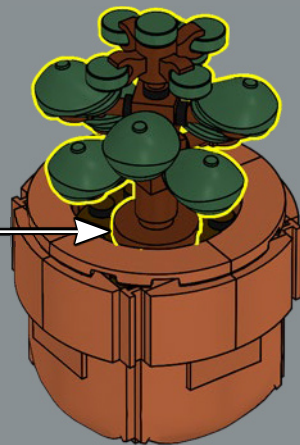

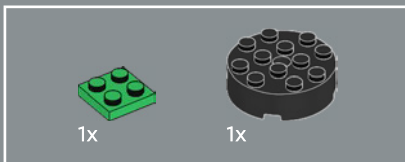
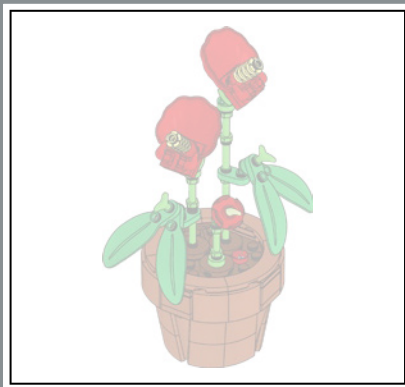

1

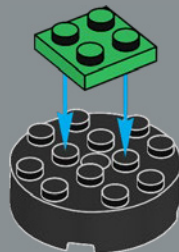

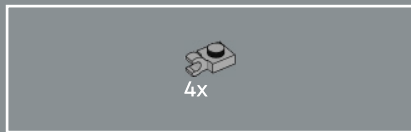

2

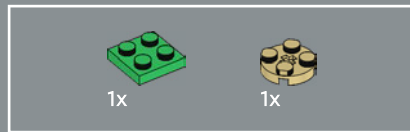
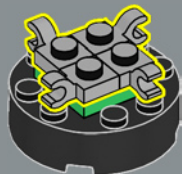

3

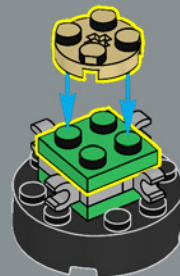

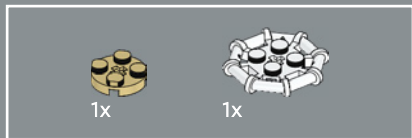

4

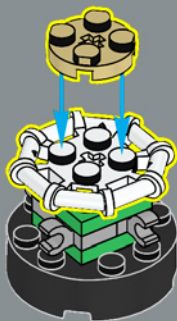

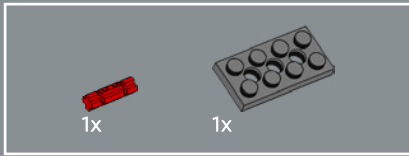

5

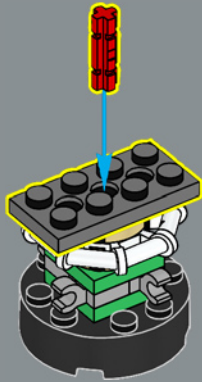

6





7

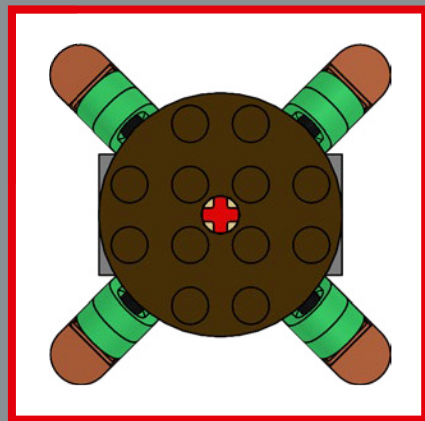
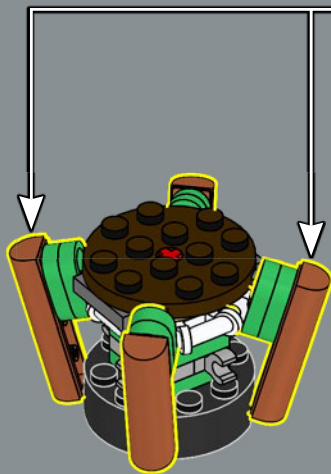
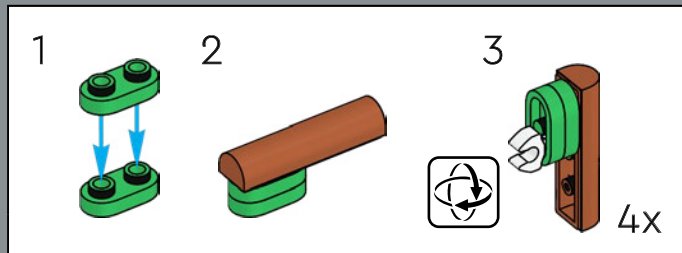

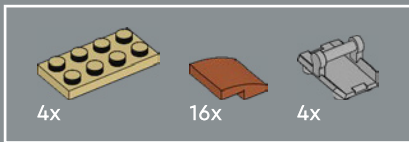

8

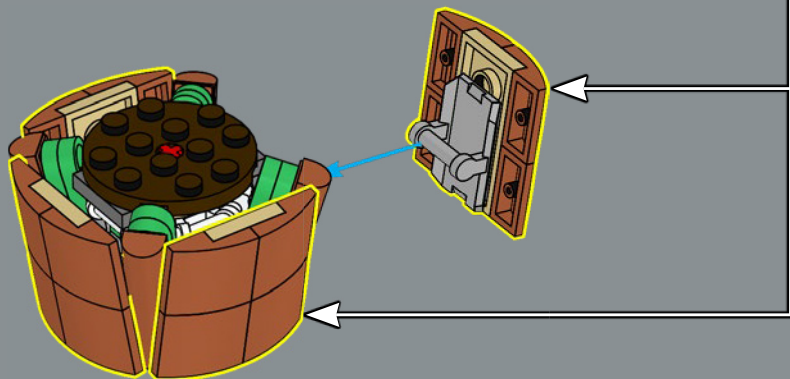
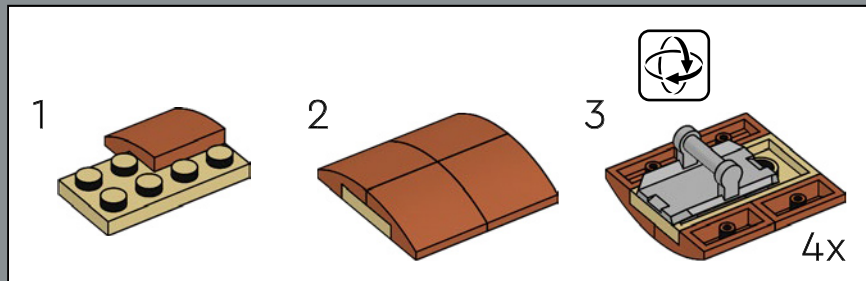

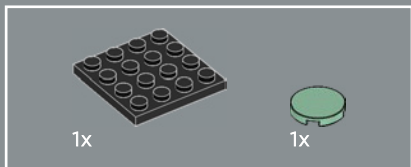
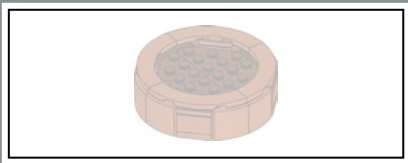

9

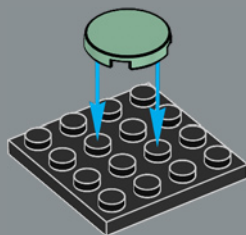



10

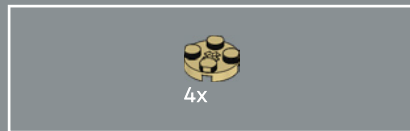
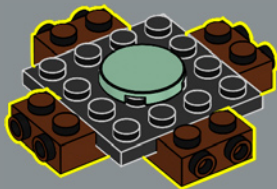

11

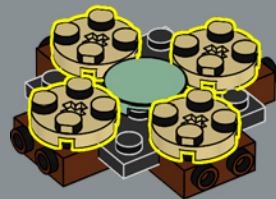



12

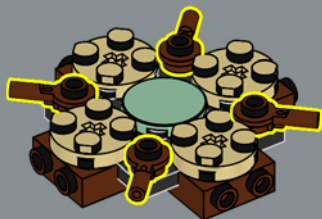

13

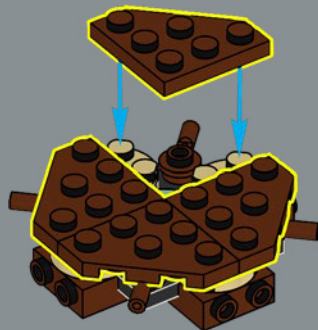

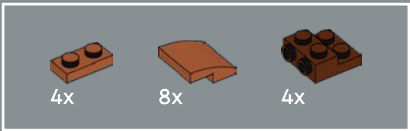

14

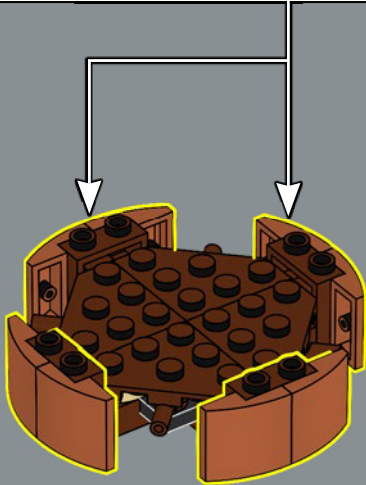
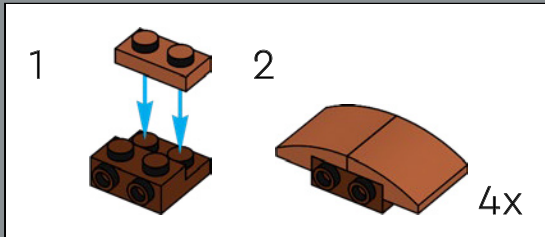



15

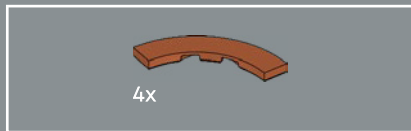
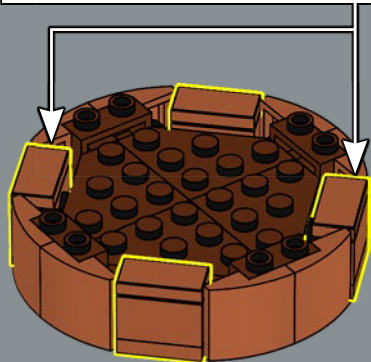
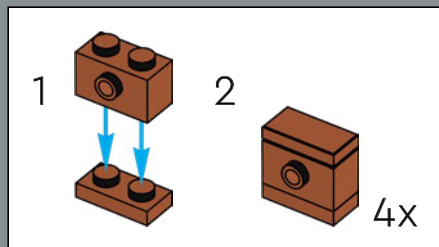

16

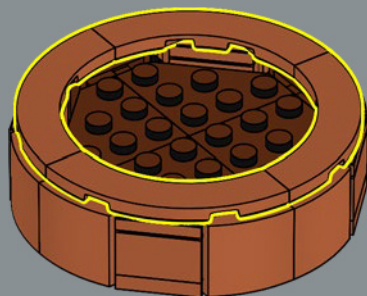

花烛容易受到蚜虫和红蜘蛛等害虫的危害，因此在花盆中放一只饥饿的瓢虫是保持植物健康的好方法。



17

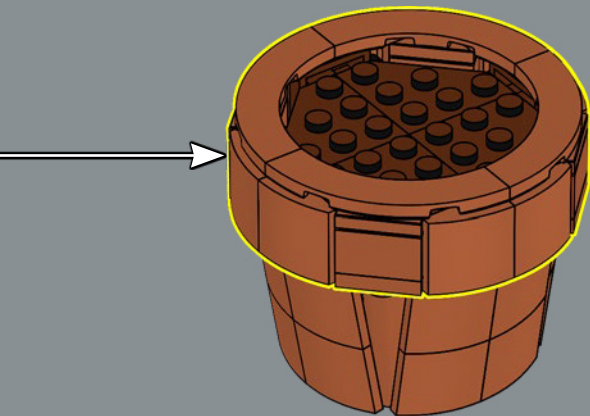

18

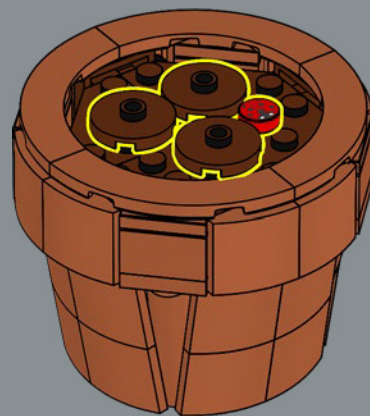



19

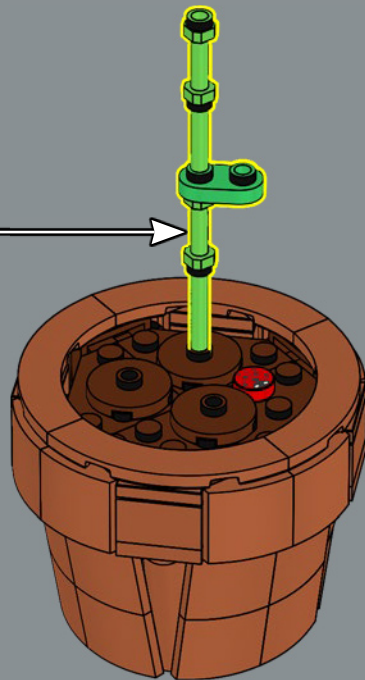
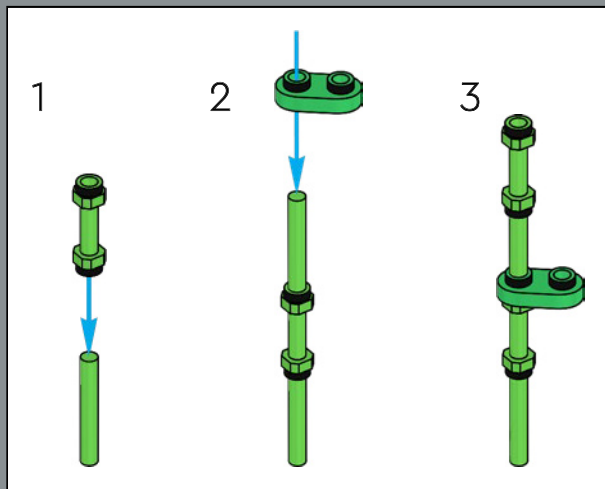

你可能还通过花烛的许多其它名称了解到它，如火鹤花或红鹅掌。我们喜欢这里的头韵！



20

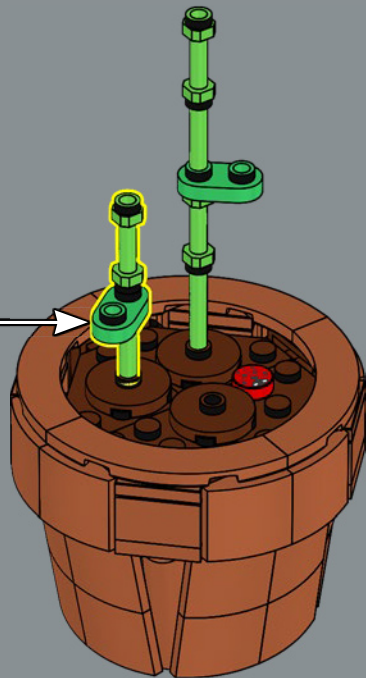
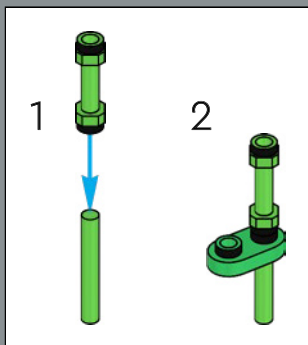

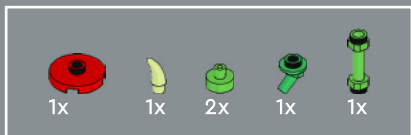

21

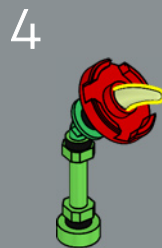
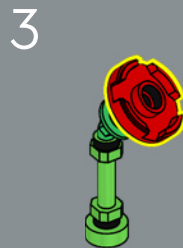
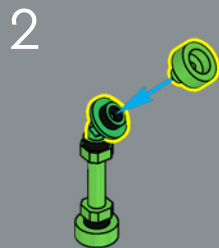
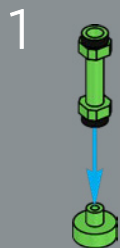

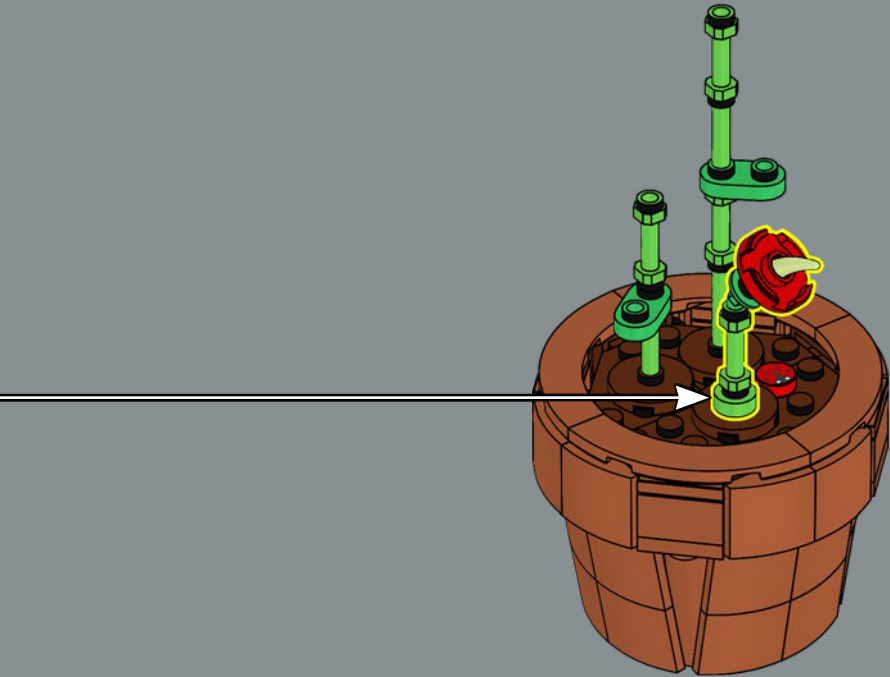

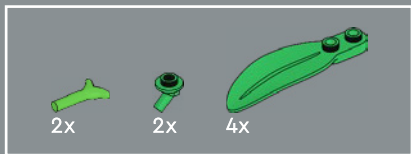

22

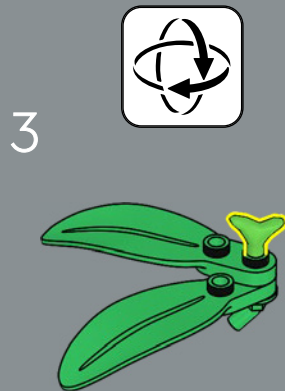
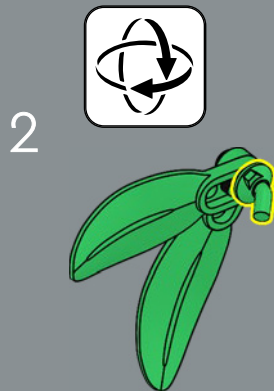
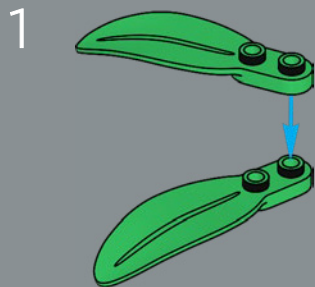

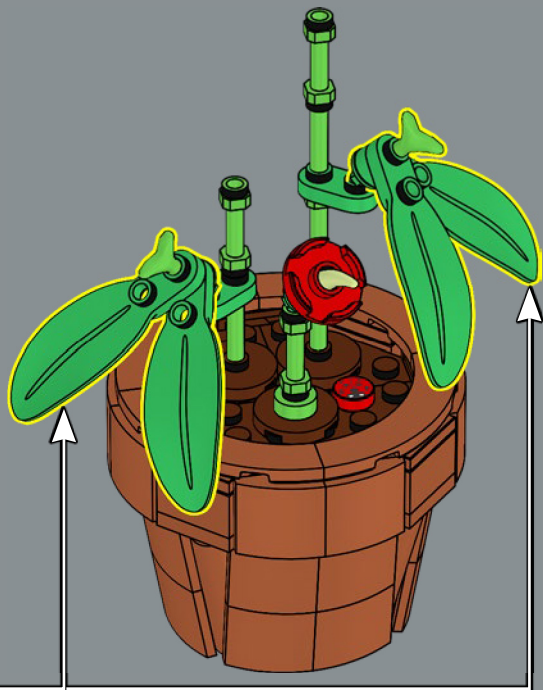



2x



2x



8x



2x



2x



2x



2x



4x



4x



2x

23

1

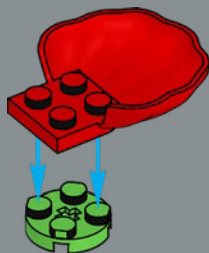

2

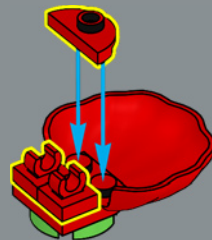

为了捕捉花烛的标志性棱纹，我们使用了
新颜色的乐高® 蛤壳组件。

3

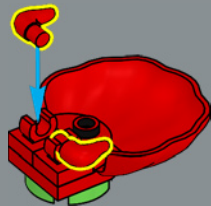

4

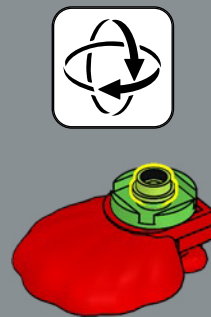

5

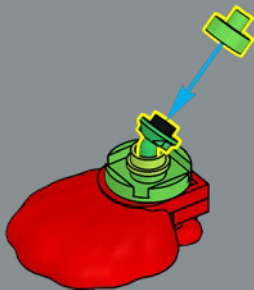

6

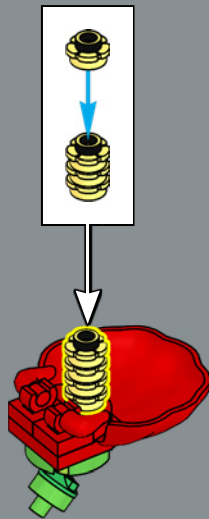

2x

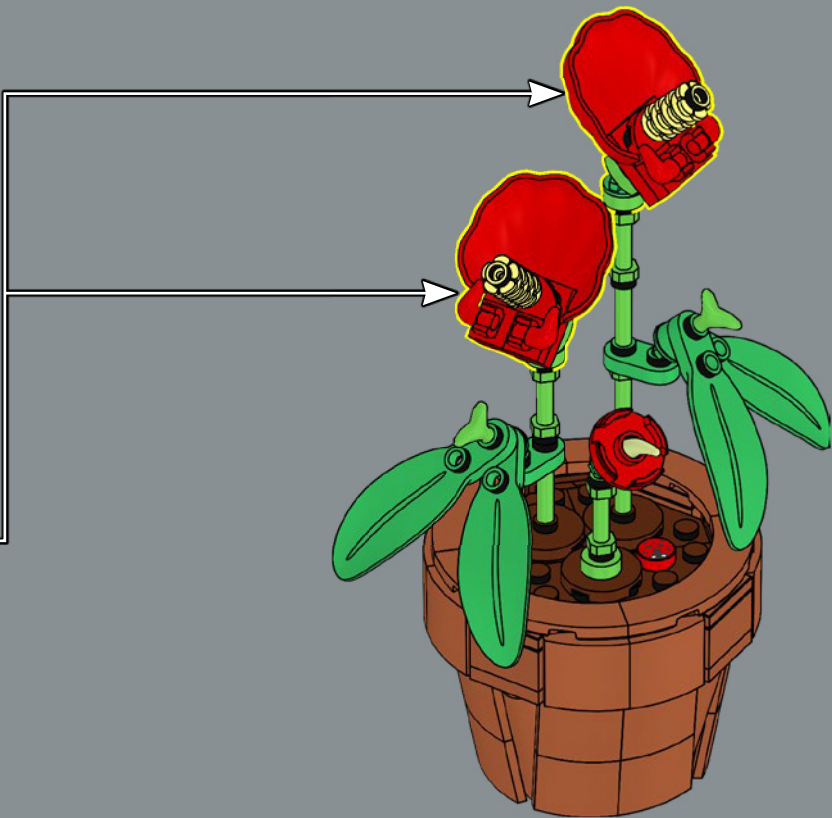



LEGO and the LEGO logo are trademarks of the LEGO Group. ©2024 The LEGO Group.