

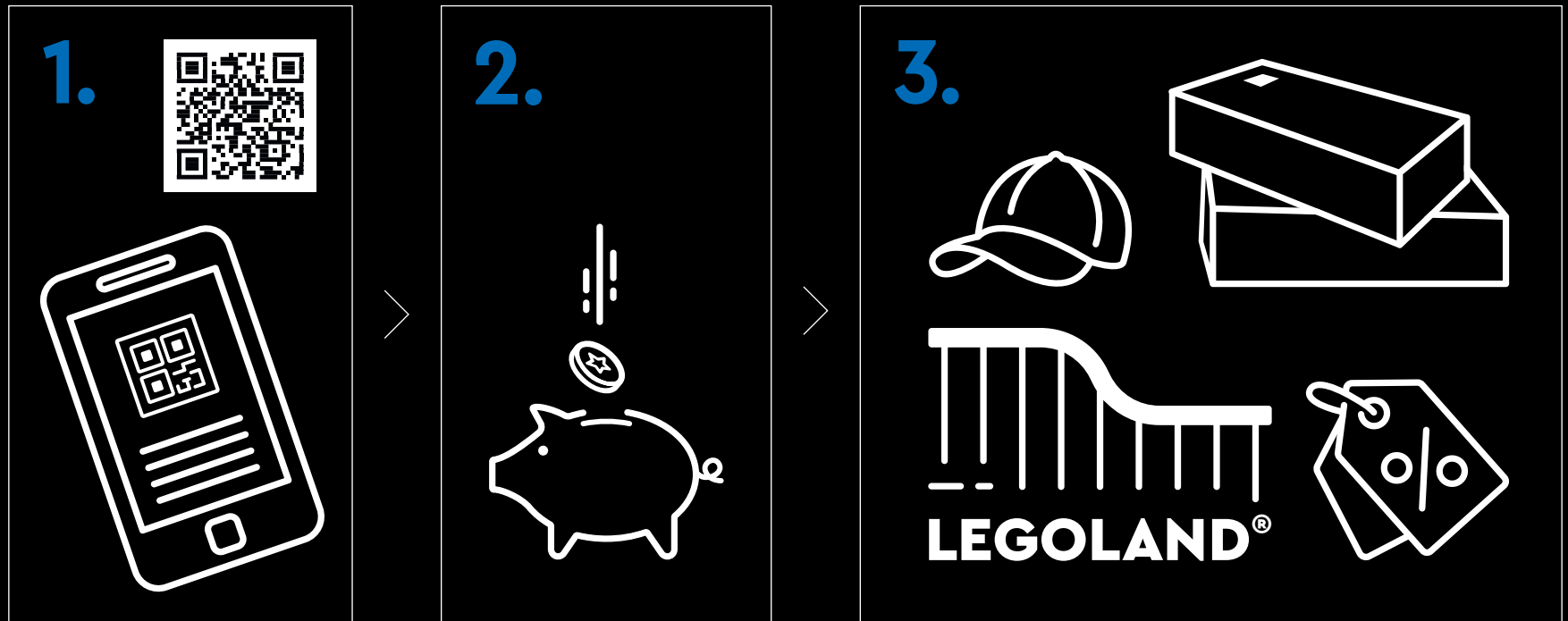



LEGO.com/sustainable-packaging

LEGO® VIP



1. Sign up 2. Earn points for purchases 3. Redeem points for rewards, experiences, discounts & more | 1. Melde dich an 2. Sammle Punkte bei jedem Kauf 3. Löse die Punkte für Belohnungen, Erlebnisse, Rabatte und Ähnliches ein | 1. Inscrivez-vous 2. Gagnez des points lors de vos achats 3. Échangez vos points contre des récompenses, des expériences, des remises et bien plus encore | 1. Iscriviti 2. Guadagna punti con i tuoi acquisti 3. Riscatta punti per premi, esperienze, sconti e altro ancora | 1. Regístrate 2. Gana puntos por tus compras 3. Canjea puntos por recompensas, experiencias, descuentos y mucho más | 1. Registe-se 2. Ganhe pontos em compras 3. Troque os pontos para prémios, experiências, descontos e muito mais | 1. 注册 2. 购物赚积分 3. 用积分兑换奖励、体验、折扣等 | 1. Zarejestruj się 2. Zdobywaj punkty za zakupy 3. Wymieniaj punkty na rabaty, przygody i inne nagrody | 1. Zaregistrujte se 2. Sbírejte body za nákupy 3. Vyměňujte body za odměny, zážitky, slevy a spoustu dalšího | 1. Zaregistrujte se 2. Získavajte body za nákupy 3. Uplatnite si body a získajte odmeny, rôzne zážitky, zľavy a ešte viac | 1. Regisztrálj 2. Szerezz pontokat minden vásárlással 3. Váltsd be pontjaidat jutalmakra, élményekre, kedvezményekre és egyebekre | 1. Înscrite-te 2. Câștigă puncte pentru achiziții 3. Valorifică puncte pentru recompense, experiențe, reduceri și multe altele | 1. Регистрируйте се 2. Получайте точки за покупки 3. Используйте точки за награды, услуги, отстъпки и т.н. | 1. Reģistrējies 2. Pelni punktus par pirkumiem 3. Izmanto punktus, lai saņemtu balvas, izklaides iespējas, atlaides un daudz ko citu | 1. Registreeru 2. Teeni ostude eest punkte 3. Lunasta punktide eest preemiad, elamused, allahindlused ja muu | 1. Užsiregistruokite 2. Pelnykite taškų už pirkinius 3. Panaudokite taškus atlygiui, funkcijoms, nuolaidoms ir ne tik





„Heute ist man nur noch selten in der freien Natur. Wir sind eine urbane und technologieabhängige Gesellschaft. Aber wir

brauchen die Natur, um uns selbst zu verstehen und Zusammenhänge herzustellen. Dieser LEGO® Garten der Stille nach dem Vorbild japanischer Gärten lässt dich automatisch über die Natur nachdenken. Und in unserem heutigen Leben ist das mit das Wichtigste.“

HOICHI KURISU
Gartendesigner und Baumeister aus Japan



Achtsames Bauerlebnis

● Folge den Trittsteinen zu deinem privaten Pavillon, mach es dir dort gemütlich, schalte ab und sei für einen Moment eins mit der Natur. Oder verweile dort einfach so lange, wie es dir gefällt.

Diesem Set dienten die Jahrtausende alten traditionellen Gärten der Stille als Vorbild. Das Modell wurde in Zusammenarbeit mit Hoichi Kurisu entwickelt, der über jahrelange Erfahrung mit der Gestaltung von Gärten der Achtsamkeit verfügt. In diesem ruhigen Zufluchtsort ohne Ablenkungen kann man seinen Gedanken nachhängen und neue Kräfte tanken. Jedes Element in dem Garten lässt dich über die farbenfrohen Wunder und die spielerische Schönheit von Mutter Erde nachdenken. Während du Zeit in deinem Garten verbringst, kannst du die Jahreszeiten wechseln lassen. Lass deiner Kreativität bei jedem Besuch freien Lauf, verändere die Szenerie, setz neue LEGO® Pflanzen oder füge Zierobjekte hinzu, die für dich bedeutsam sind. Mach dir ein Kännchen deines geliebten Matcha-Tees, hör dir einen beruhigenden Soundtrack mit Geräuschen aus der Natur an, streif dir deine bequemsten Pantoffeln über und lass deine Gedanken schweifen.





Pflege deinen Garten

„Das Bauen eines LEGO® Sets kann ein ebenso fesselndes wie befreiendes Erlebnis sein – genau wie das Lesen eines Buchs. Beim Bauen kannst du dich auf etwas konzentrieren, was Spaß macht. Und das Modell vermittelt dir noch lange nach seiner Fertigstellung ein tolles Erfolgsgefühl. In diesen Garten kannst du so oft zurückkehren, wie du möchtest. Pflege die Elemente und verändere die Landschaft genau wie in einem echten Garten oder wie einen Bonsai-Baum. Stell den Bambus, die immergrünen Pflanzen und die blühenden Kirschbäume woanders auf oder stütze sie. Stell die glatten Steinlaternen nach Lust und Laune um. Oder bestaune die lebhaften Koi und die Seerosen im plätschernden Teich und gib dich einfach deiner gestalterischen Freiheit hin.“

„Verleihe diesem Set deine ganz persönliche Note,
damit es deine Stimmung widerspiegelt.“

MICHAEL PSIAKI & CARL MERRIAM
LEGO® Icons Modelldesigner



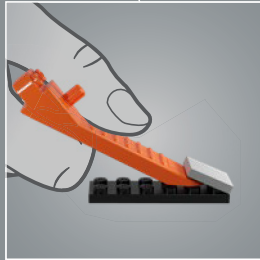
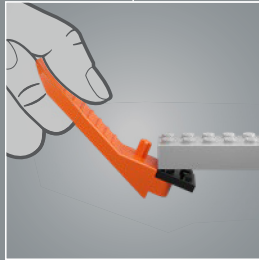
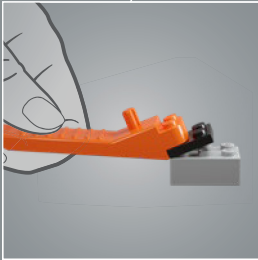
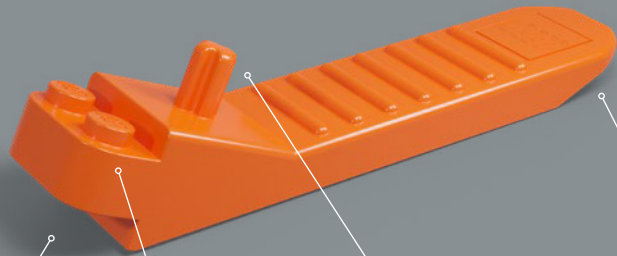

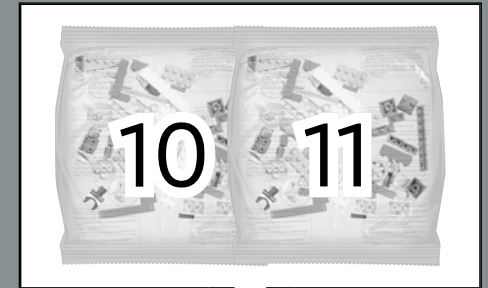
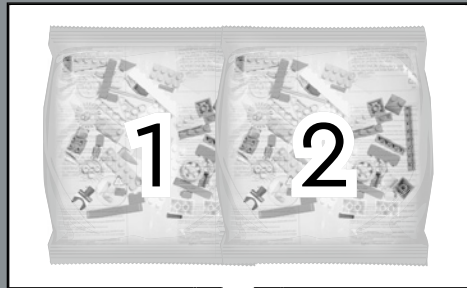

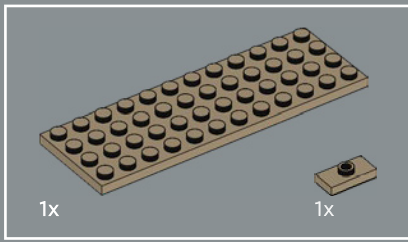
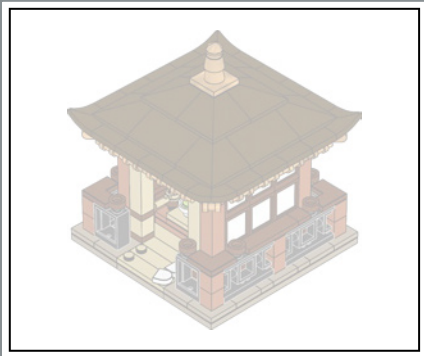

1

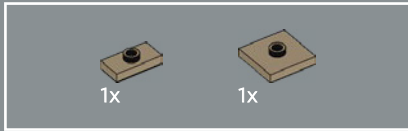
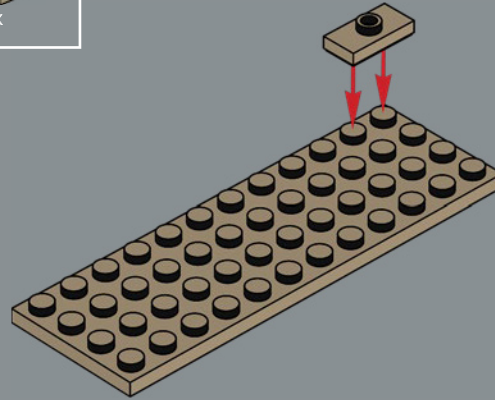

2

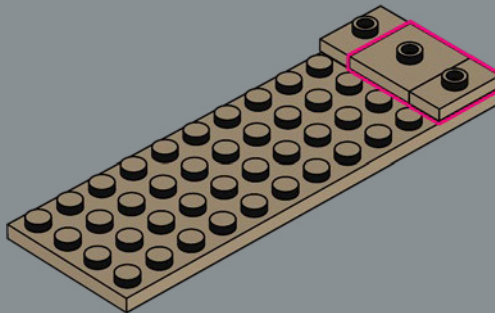

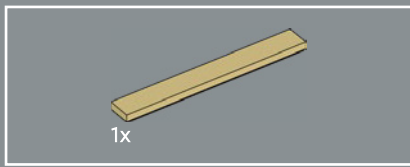

3

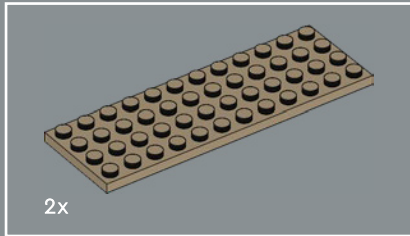
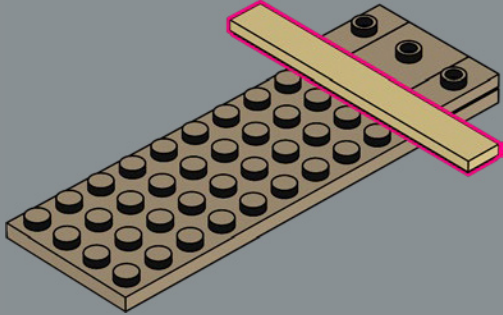

4

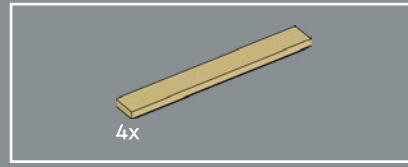
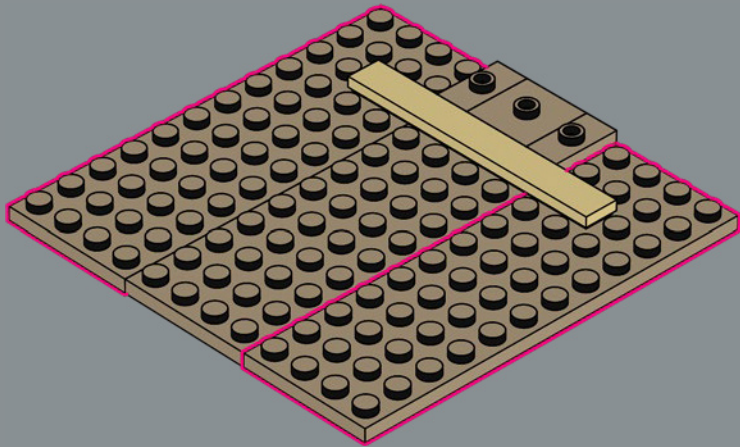

5

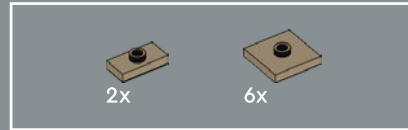
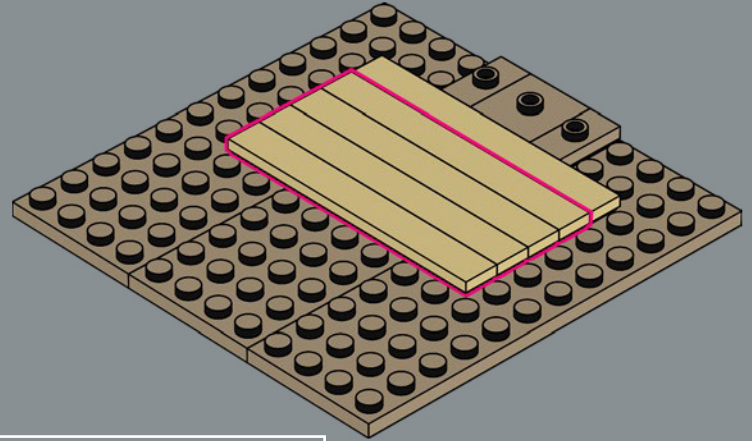

6

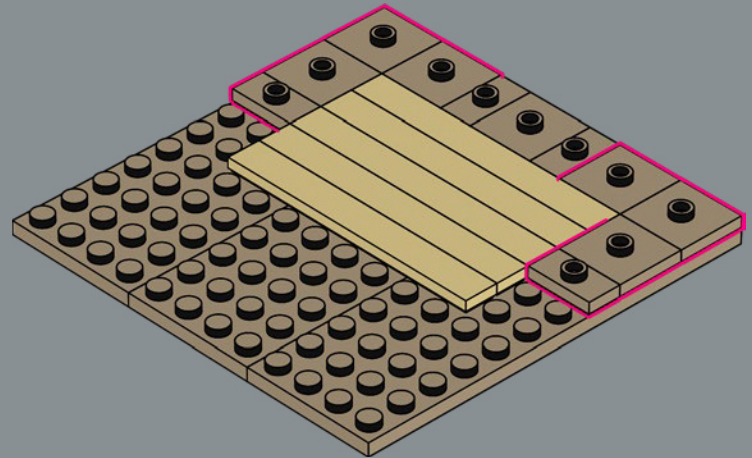

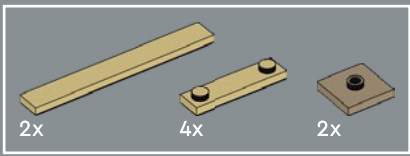

7

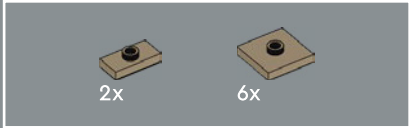
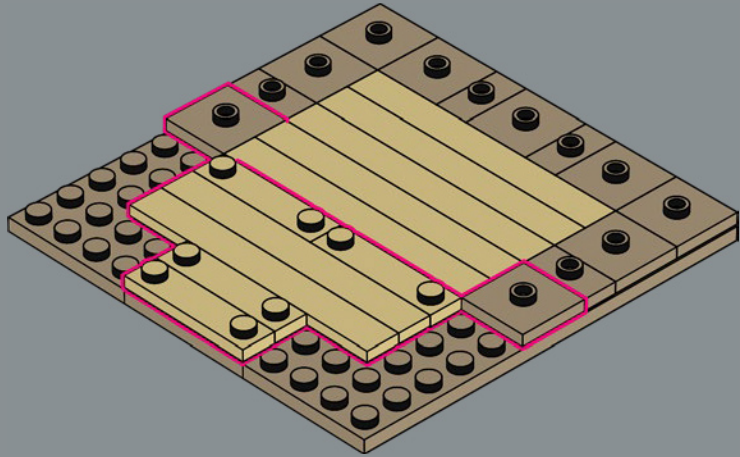

8

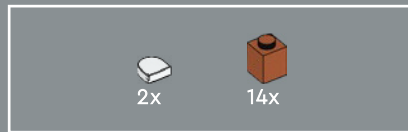
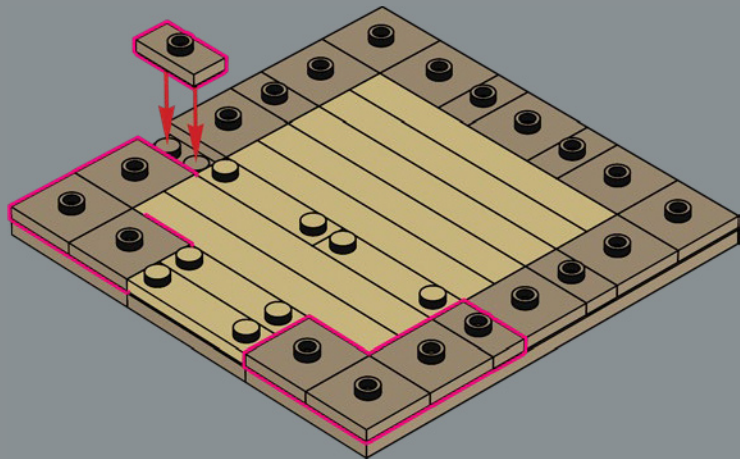

9

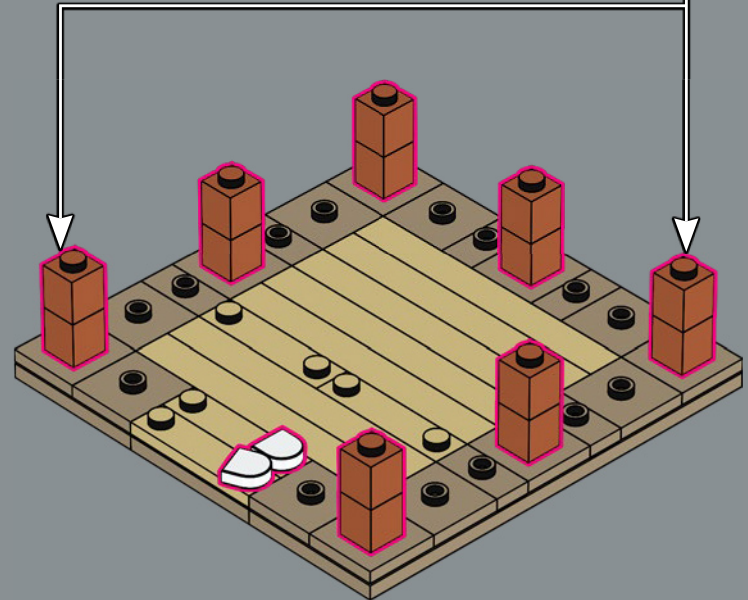
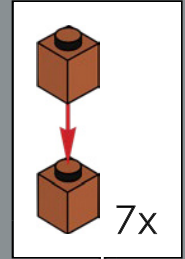

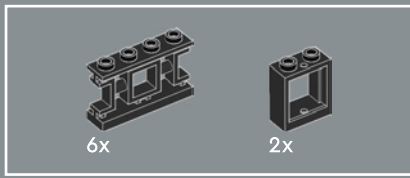

10

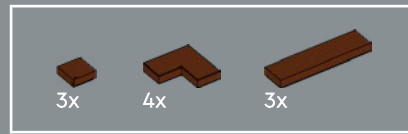
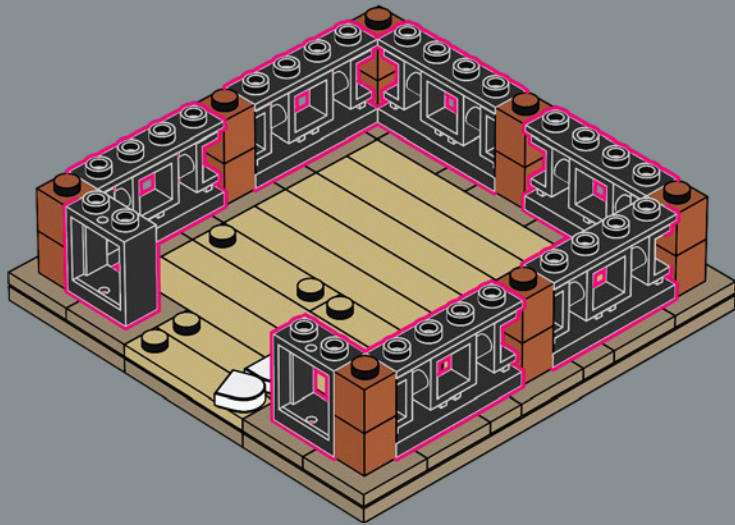

11

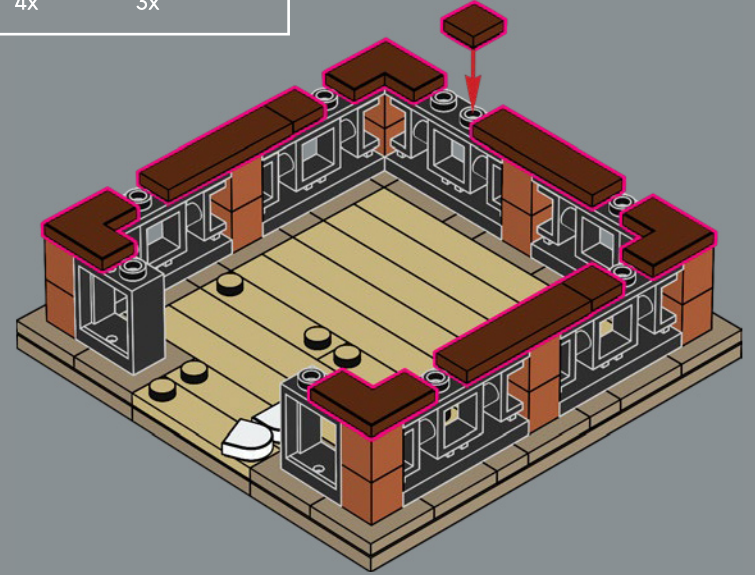

12

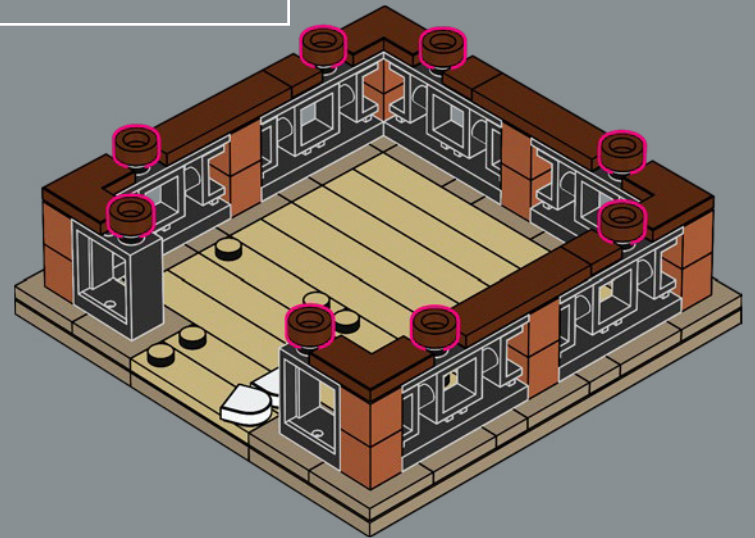

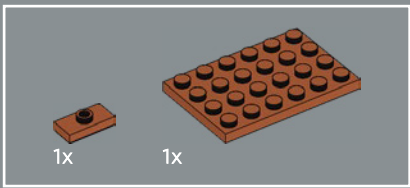

13

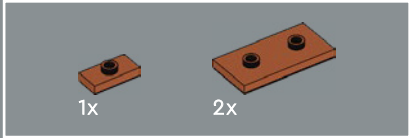
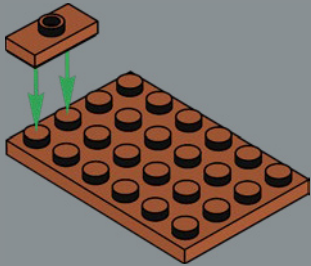

14

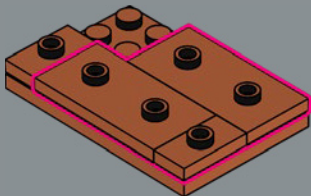

15

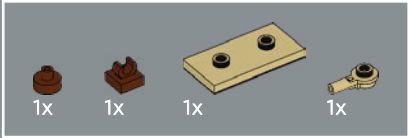
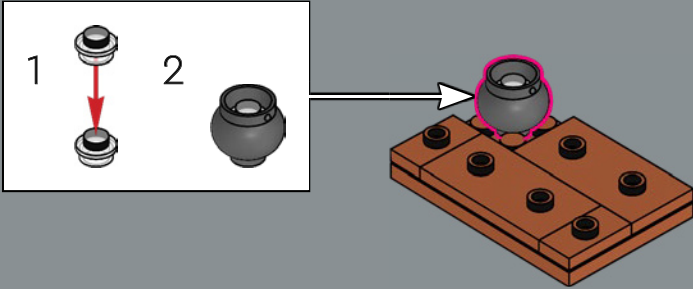

16

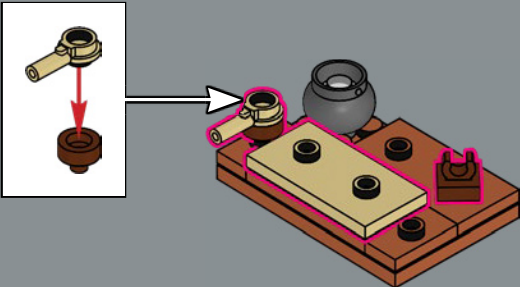

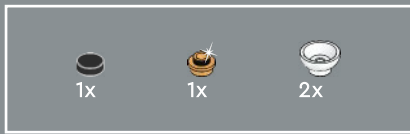

17

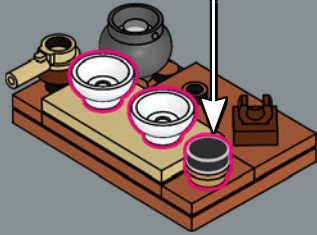
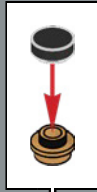

18

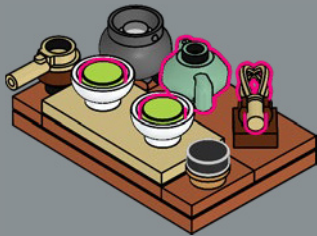

19



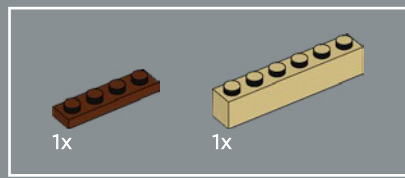

20

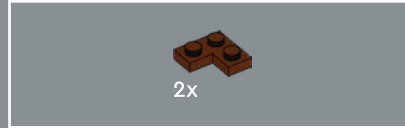
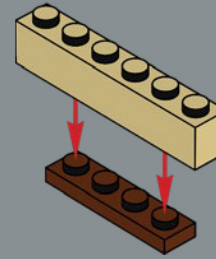

21

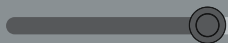
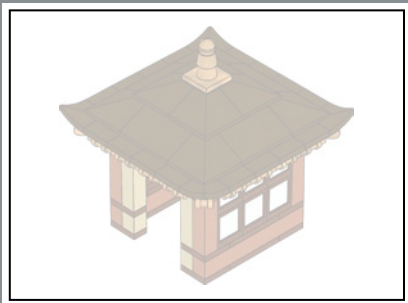
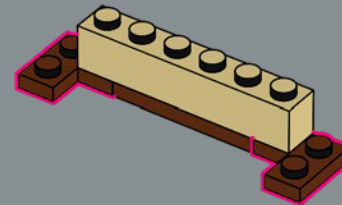

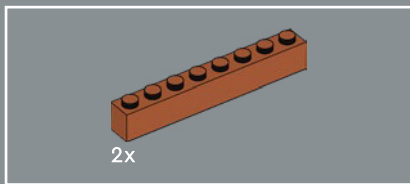

22

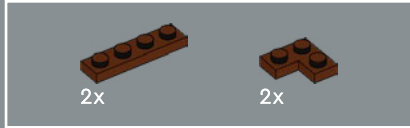
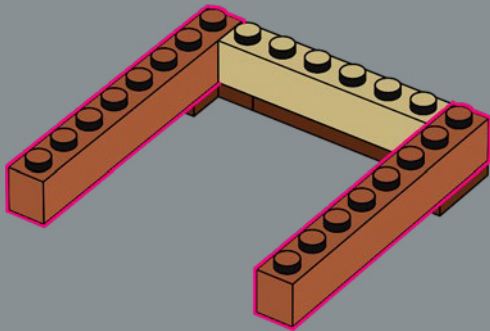

23

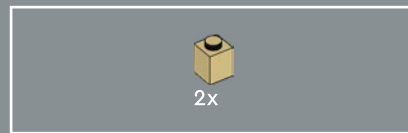
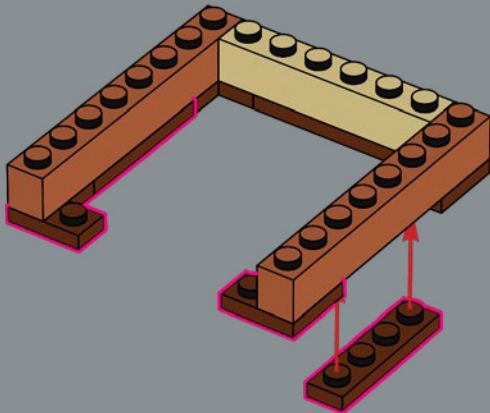

24

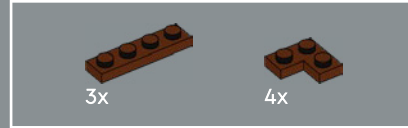
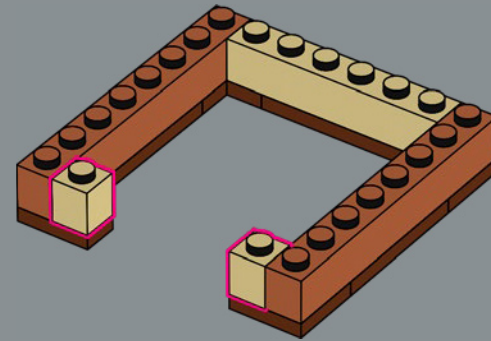

25

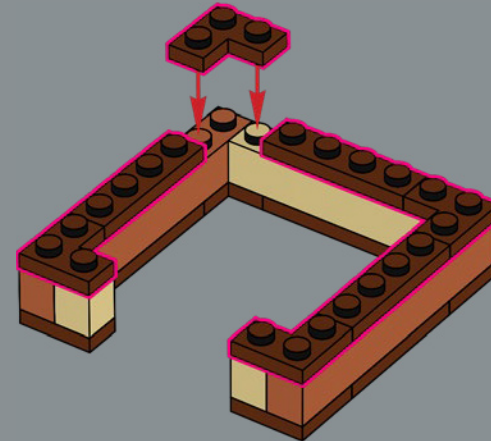

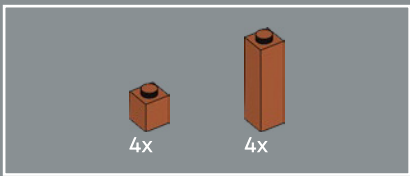

26

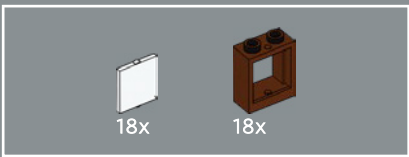
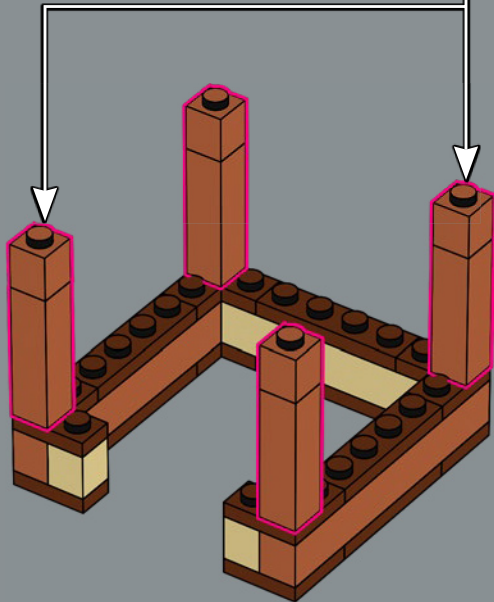
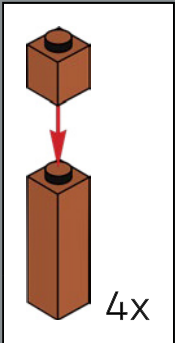

27

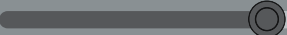
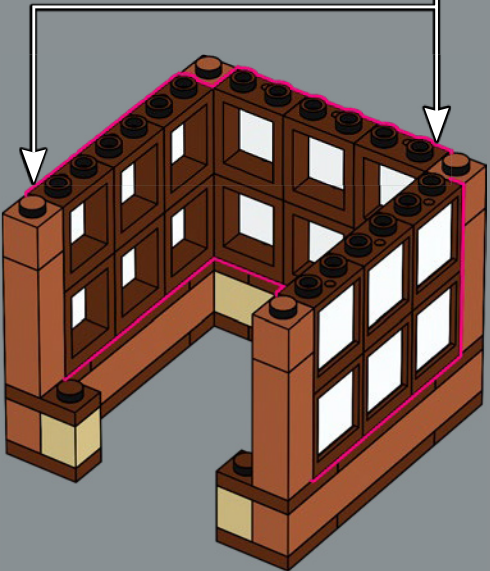
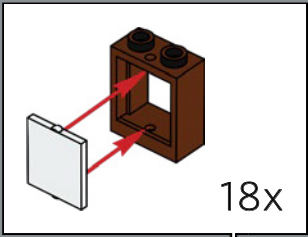

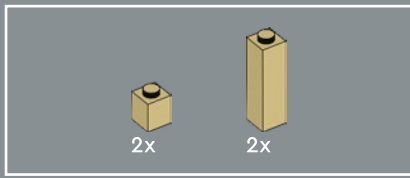

28

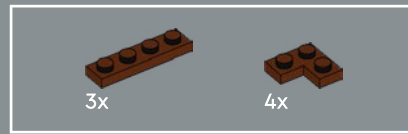
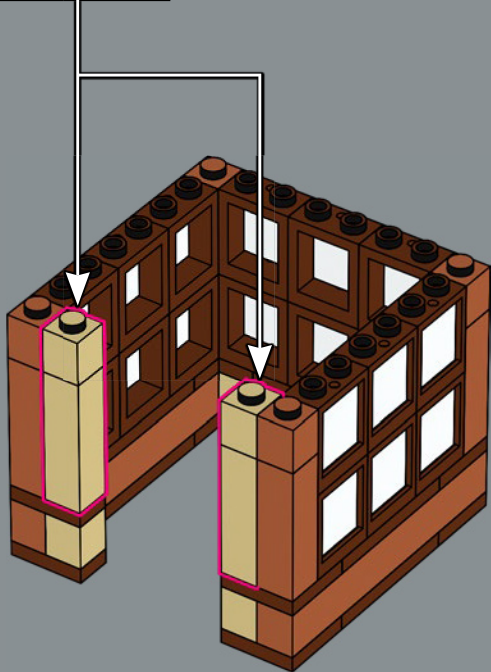
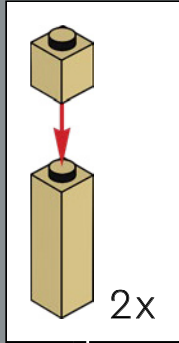

29

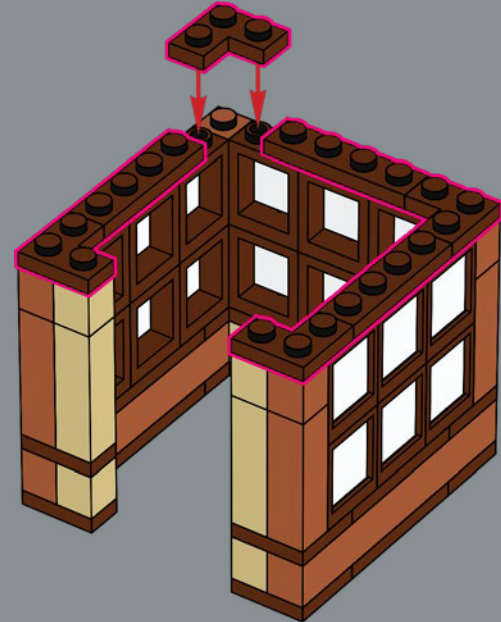

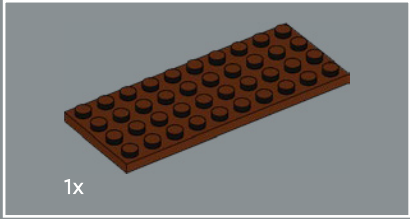
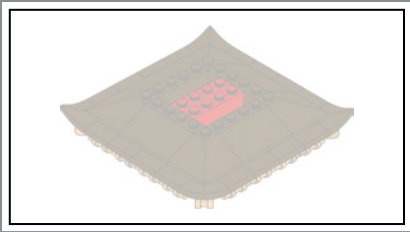

30

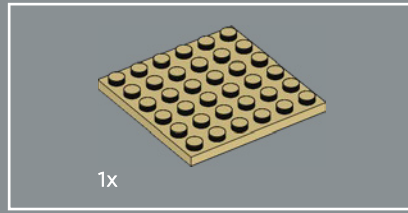
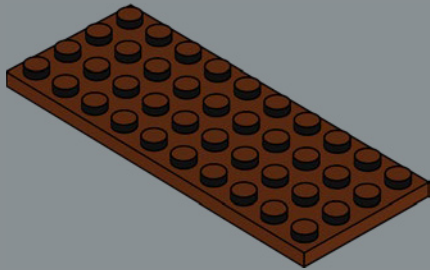

31

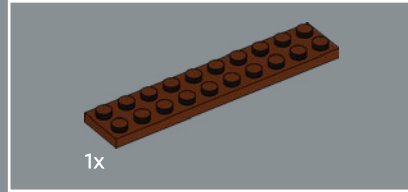
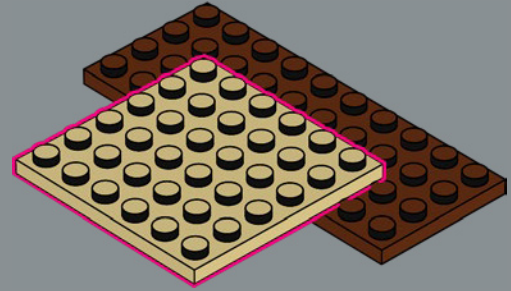

32

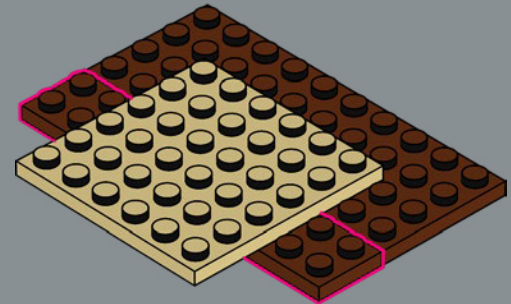

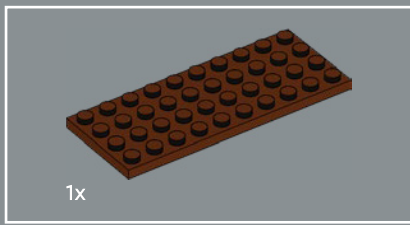

33

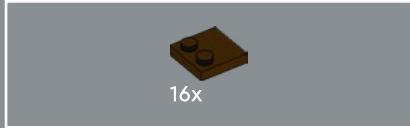
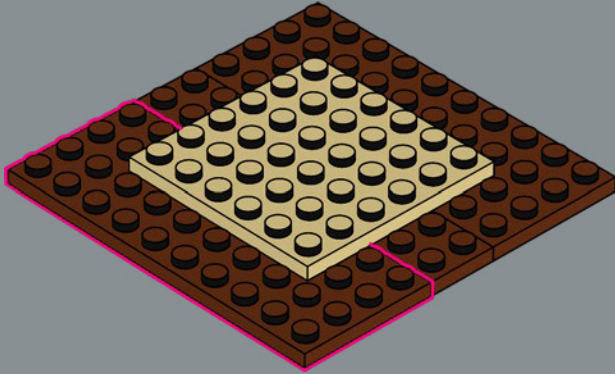

34

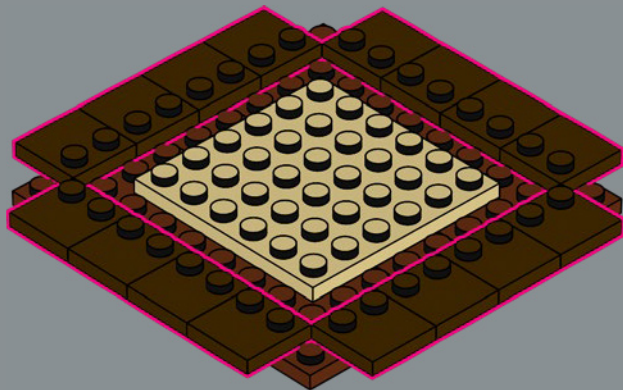

35

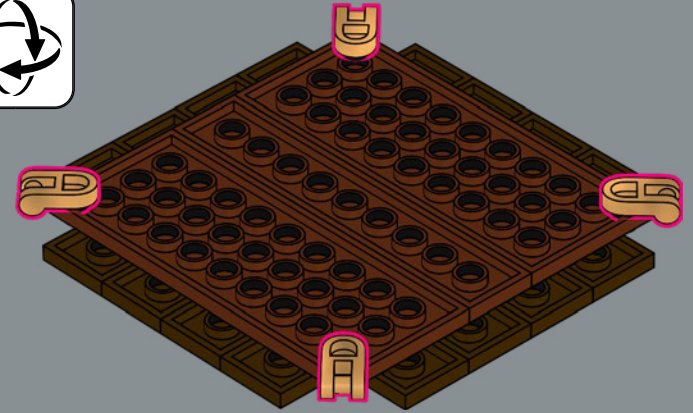

36

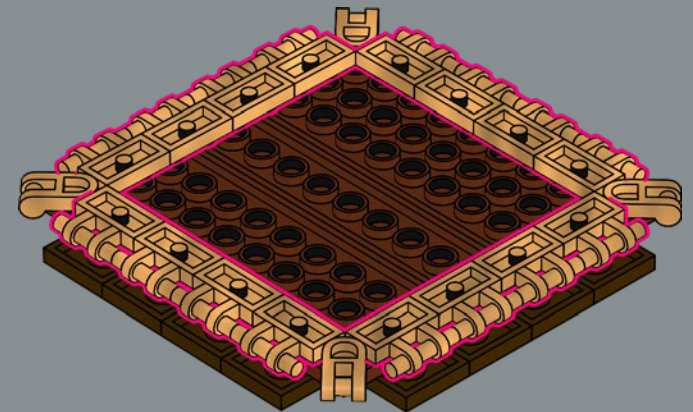

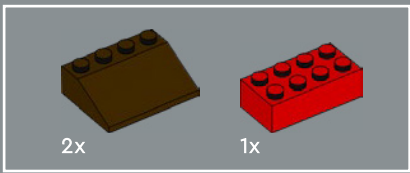

37

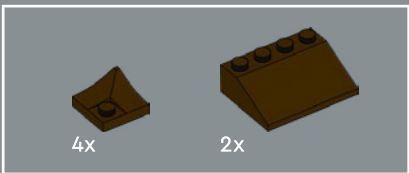
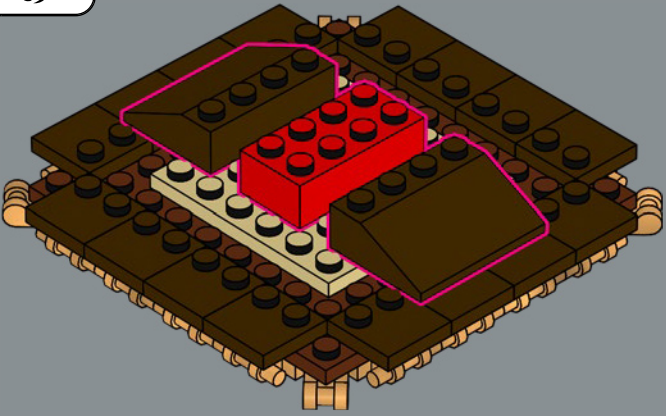

38

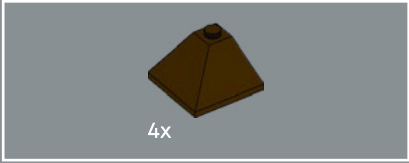
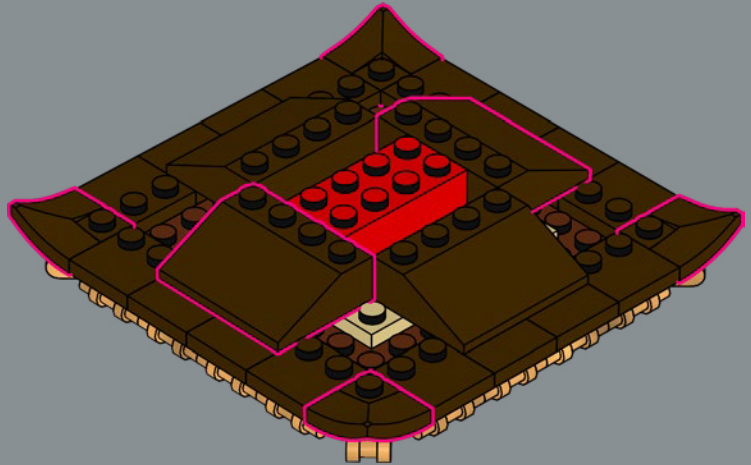

39

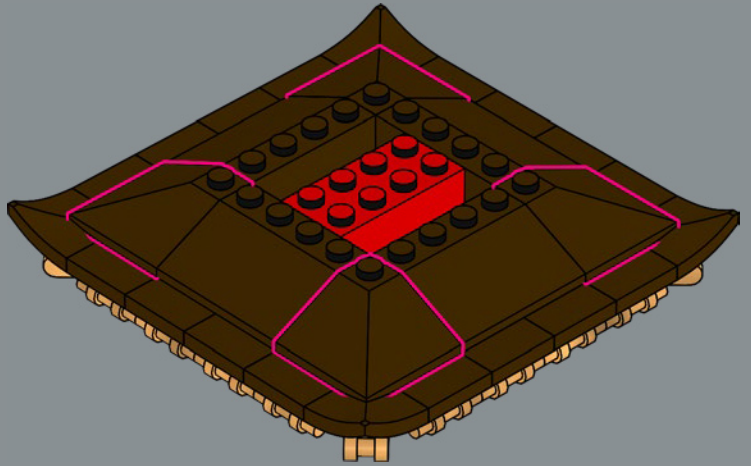

40



41

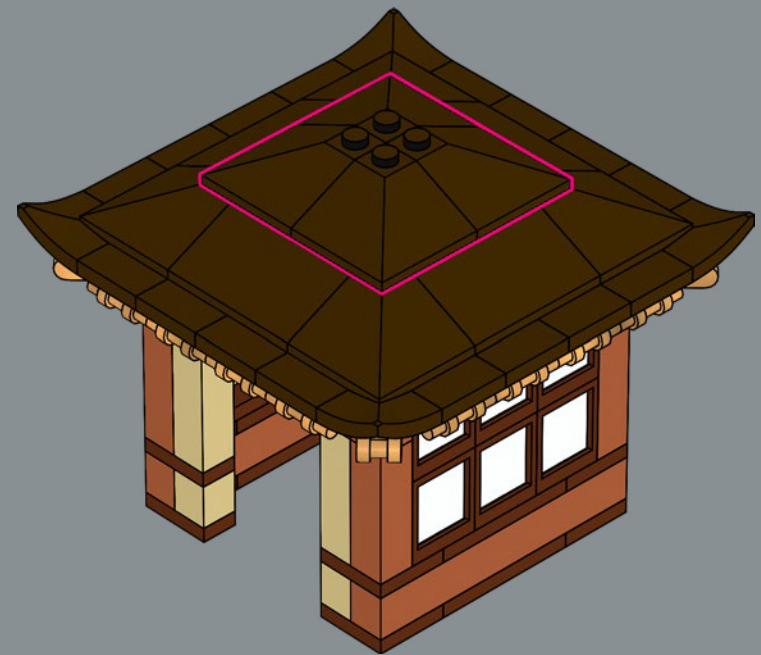



Die meisten Pavillons in Gärten der Stille sind aus Holz gebaut, um sich in die natürliche Umgebung einzufügen.



42

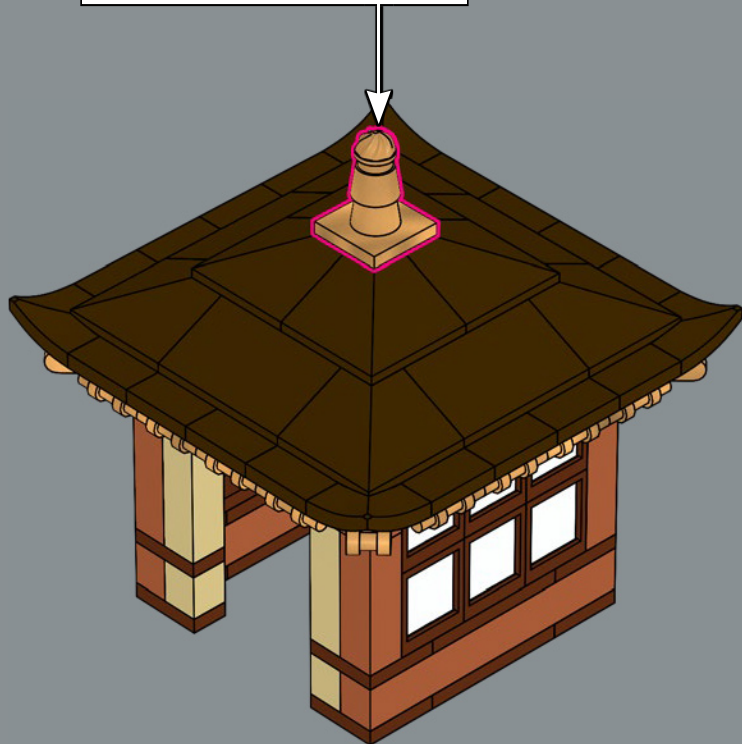
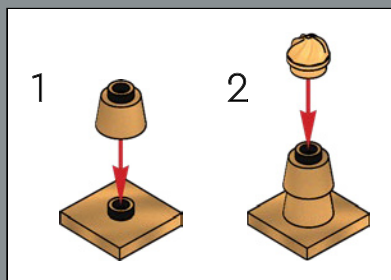

43

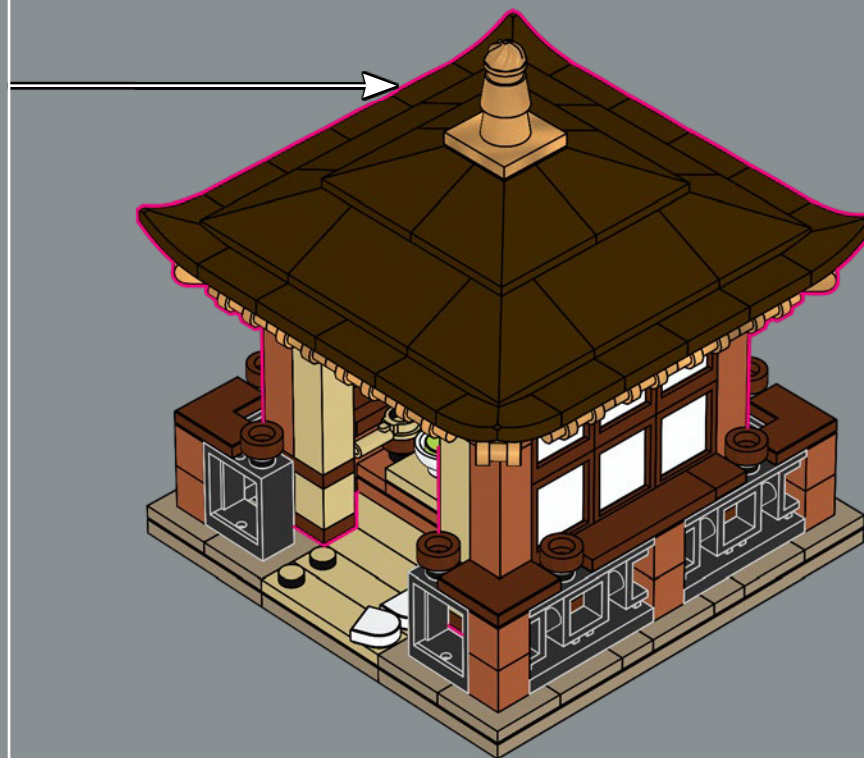

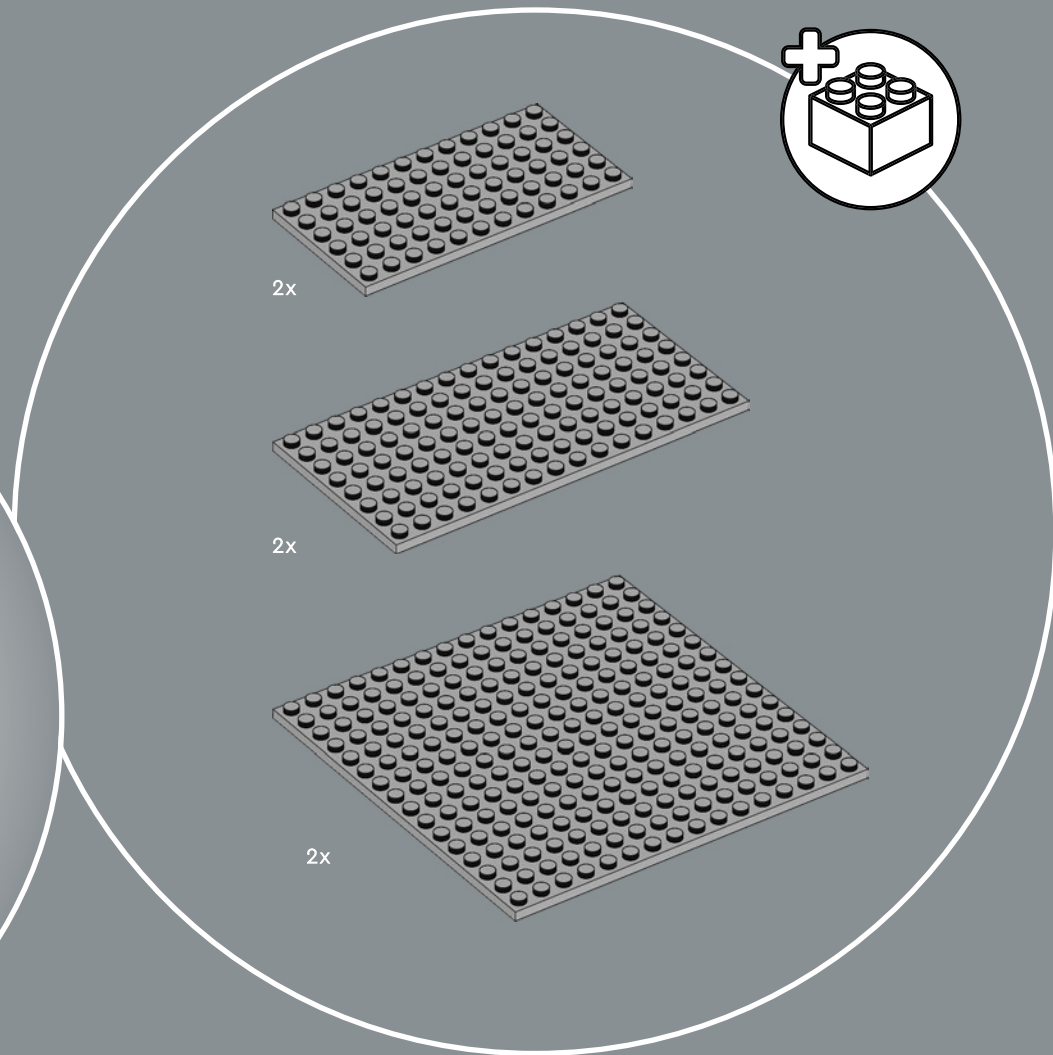

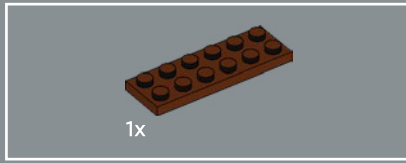
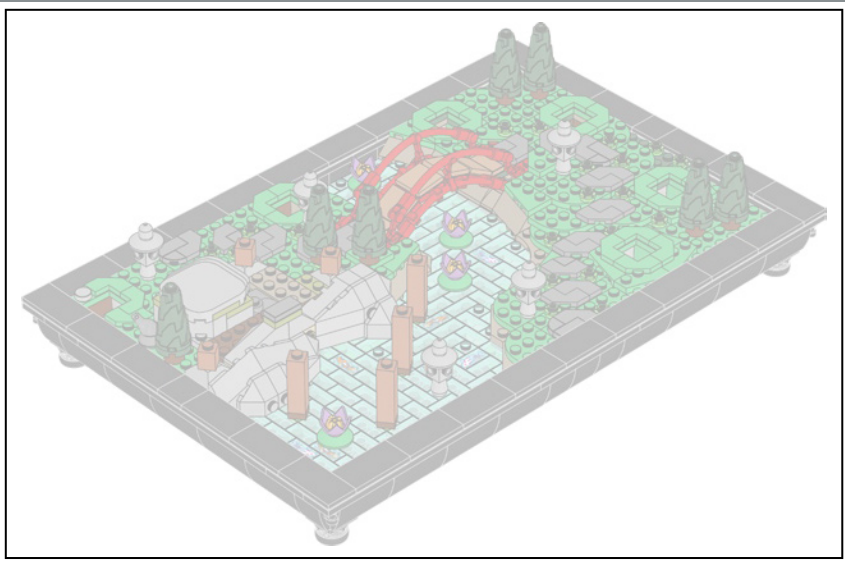

44

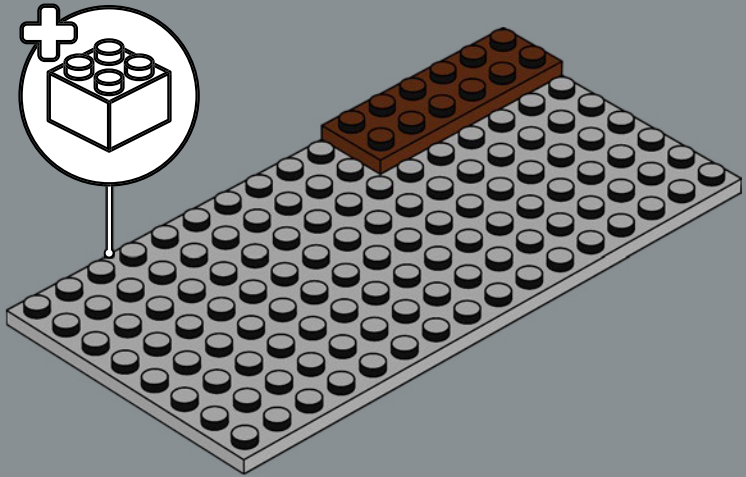

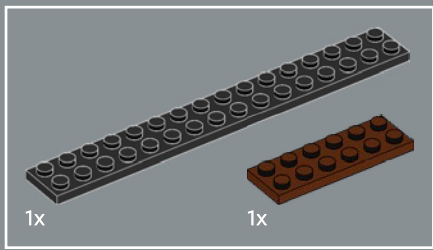

45

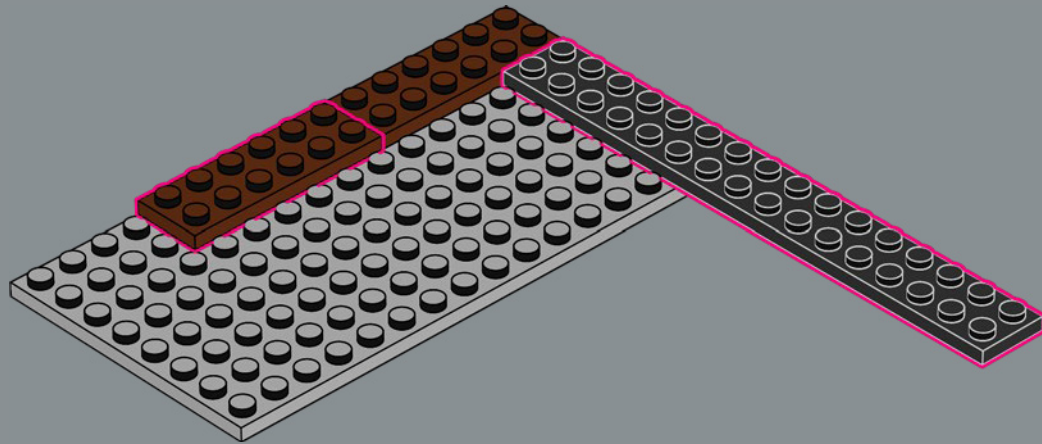

46

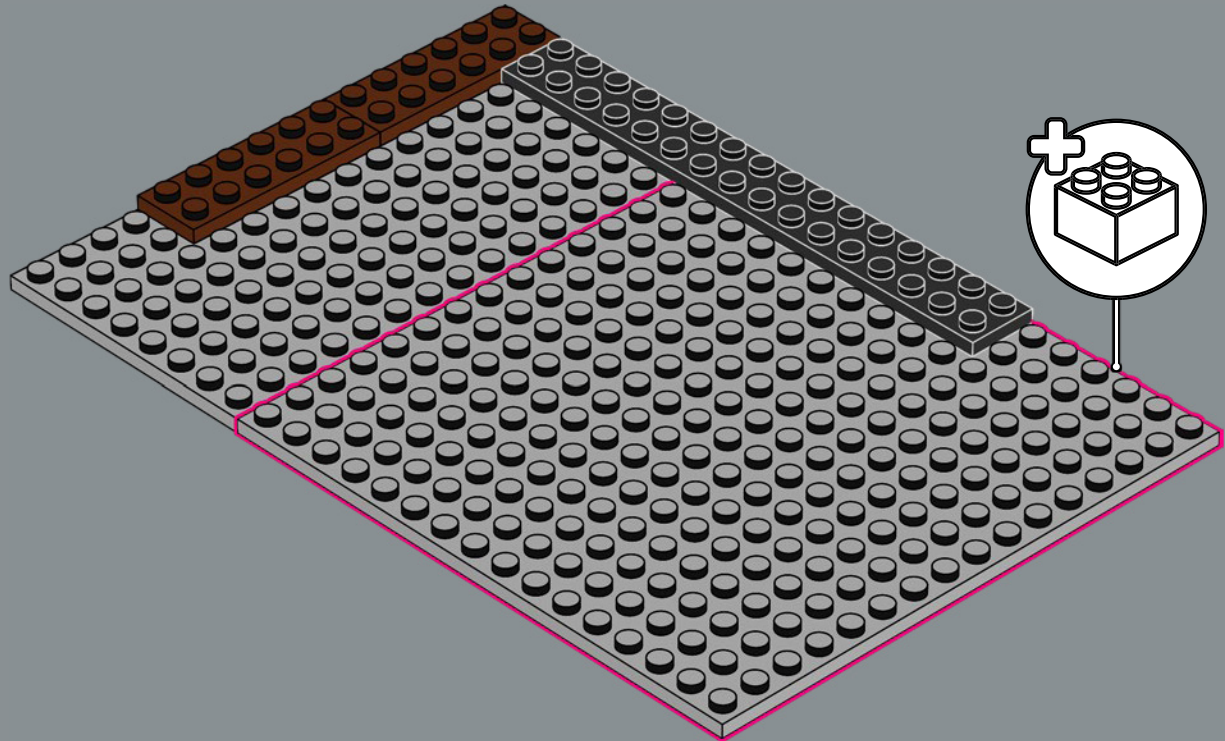

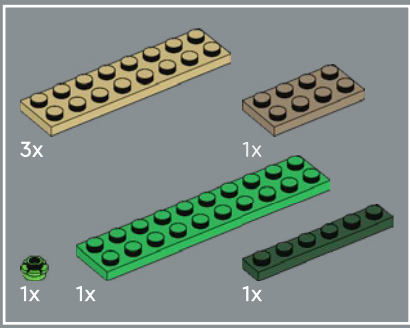

47

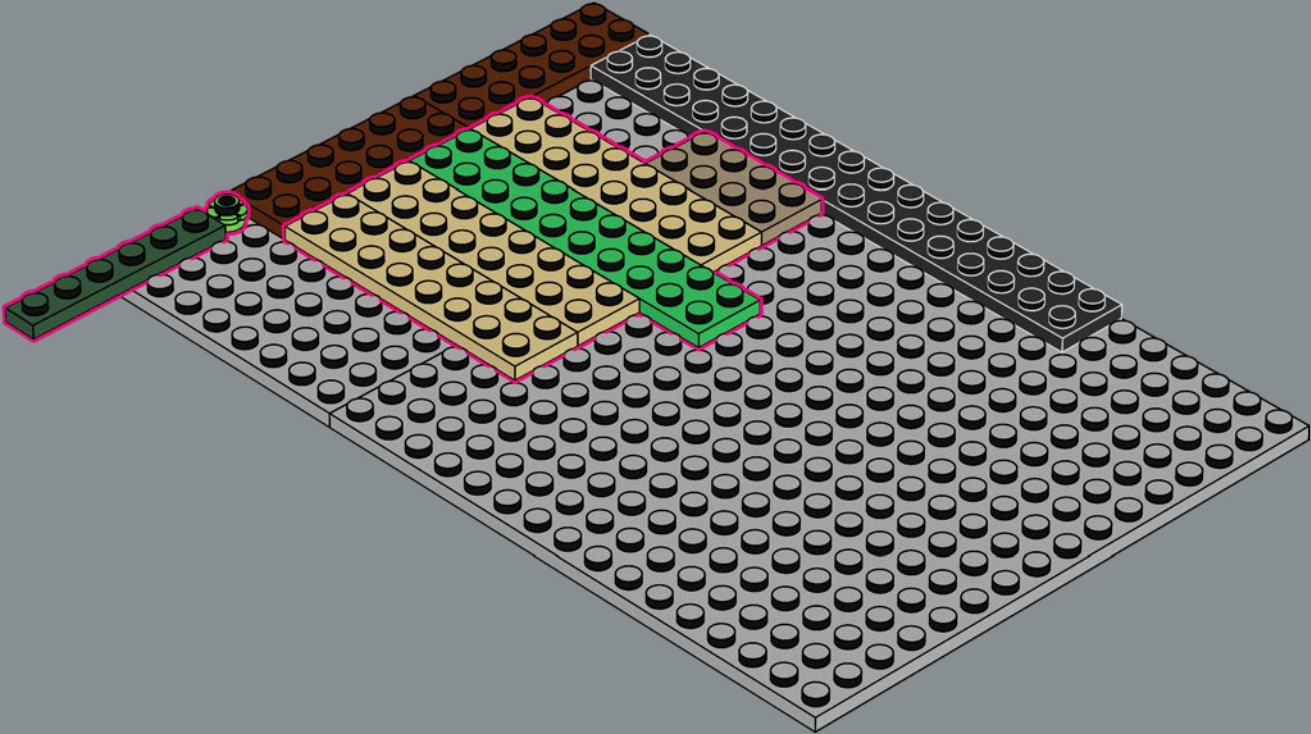

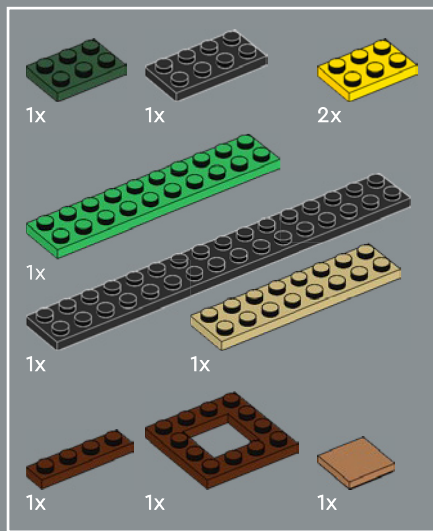

48

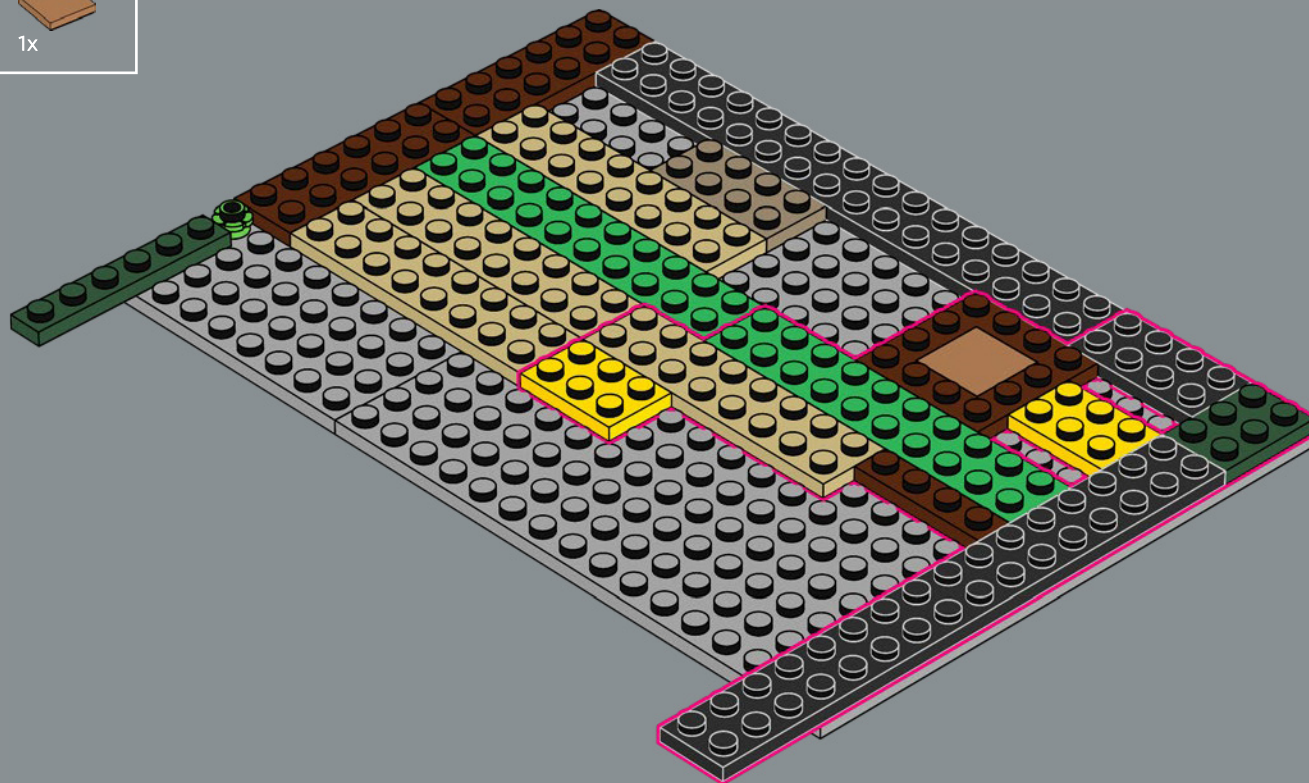

49

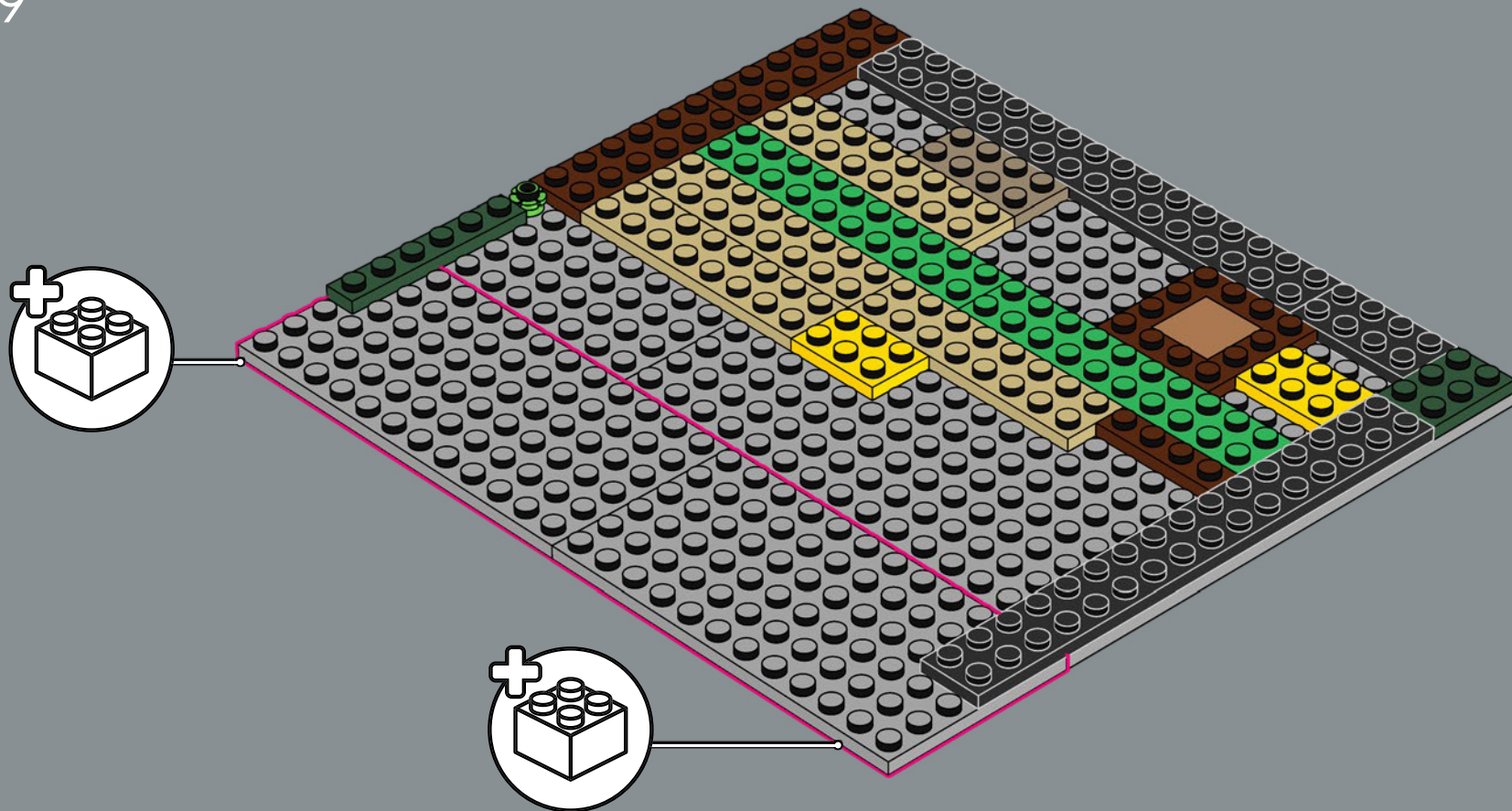

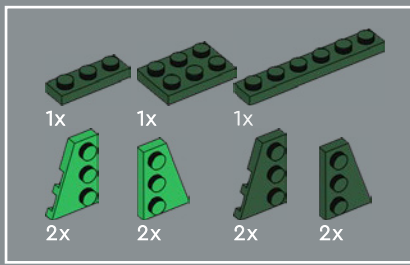

50

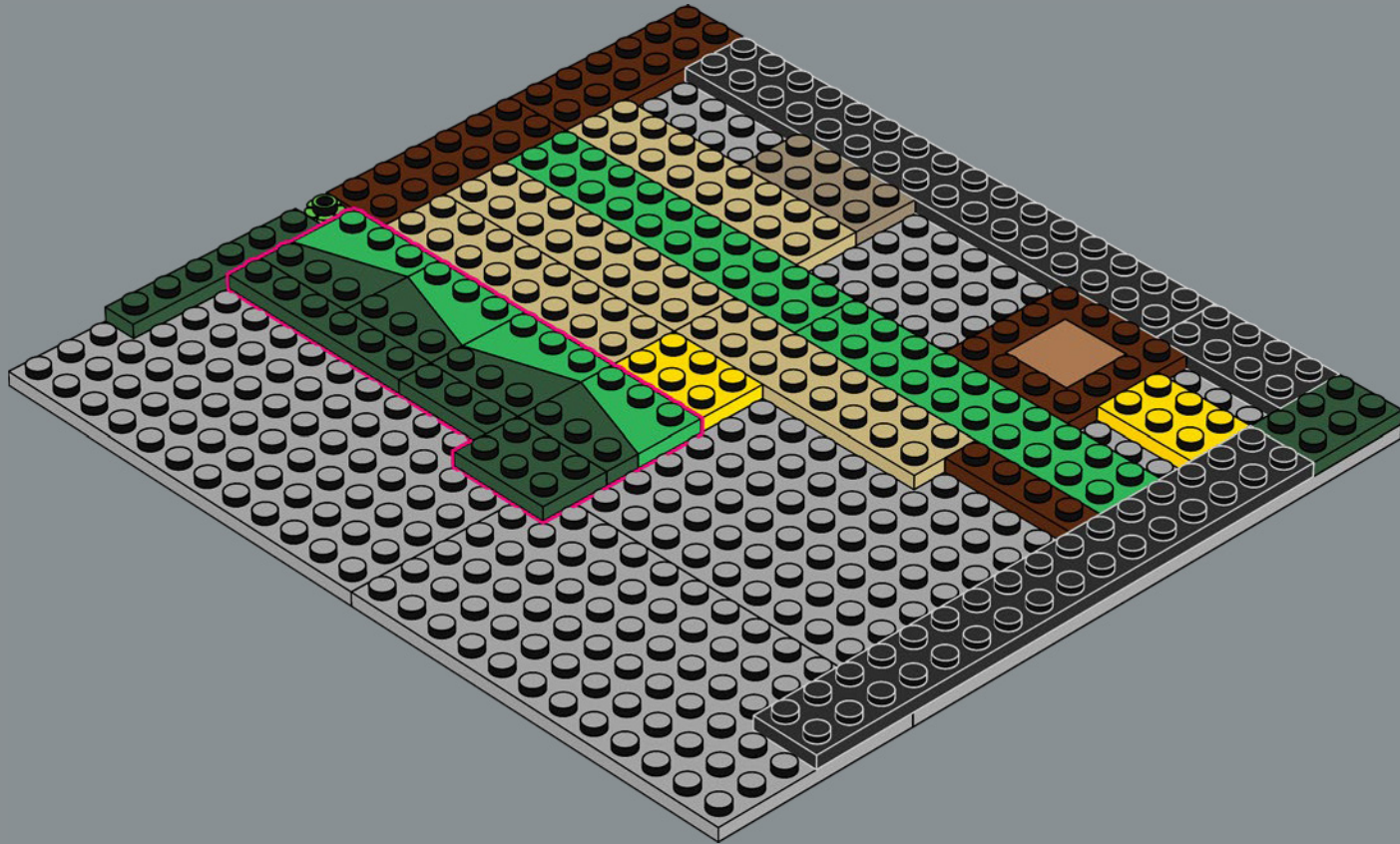

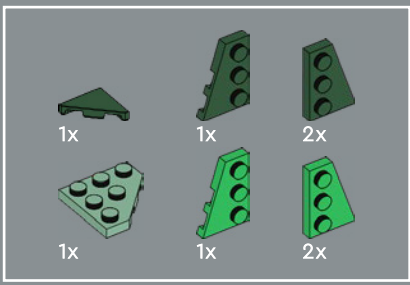

51

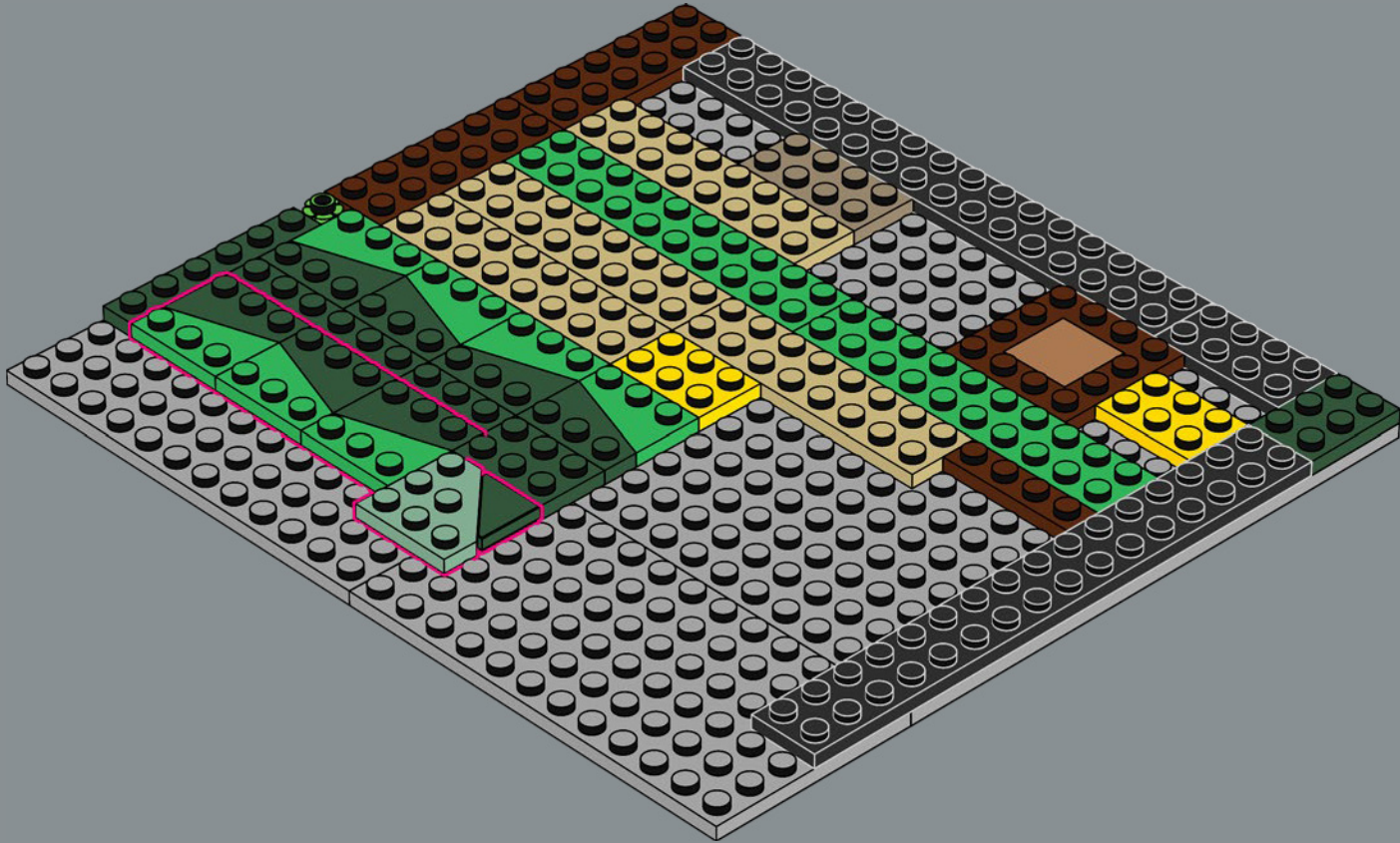

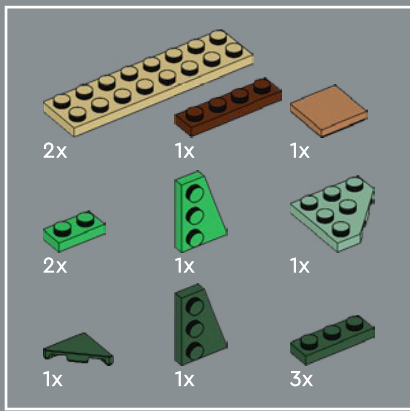

52

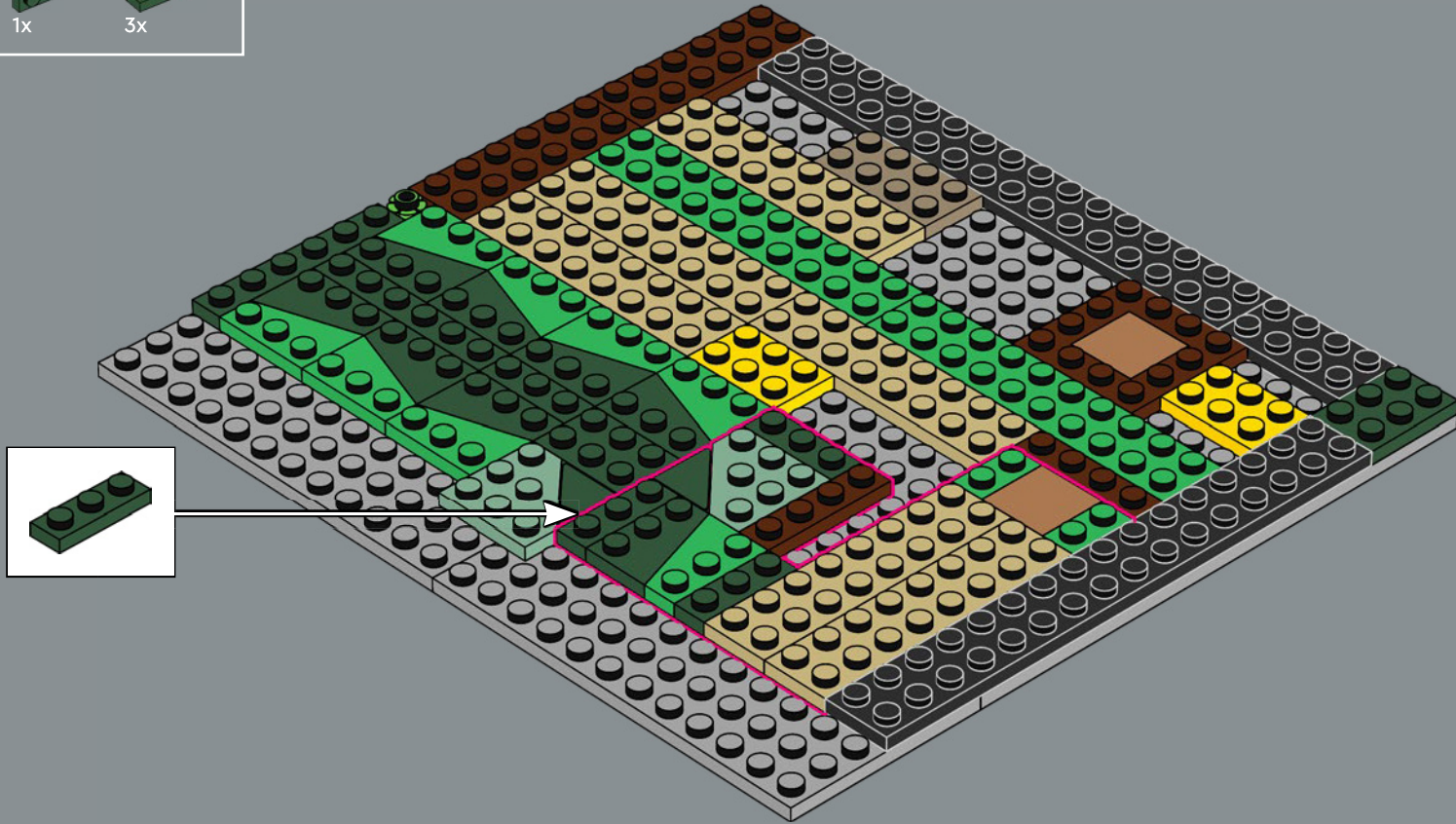

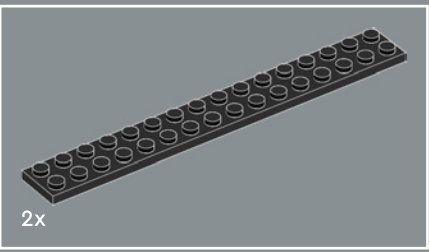

53

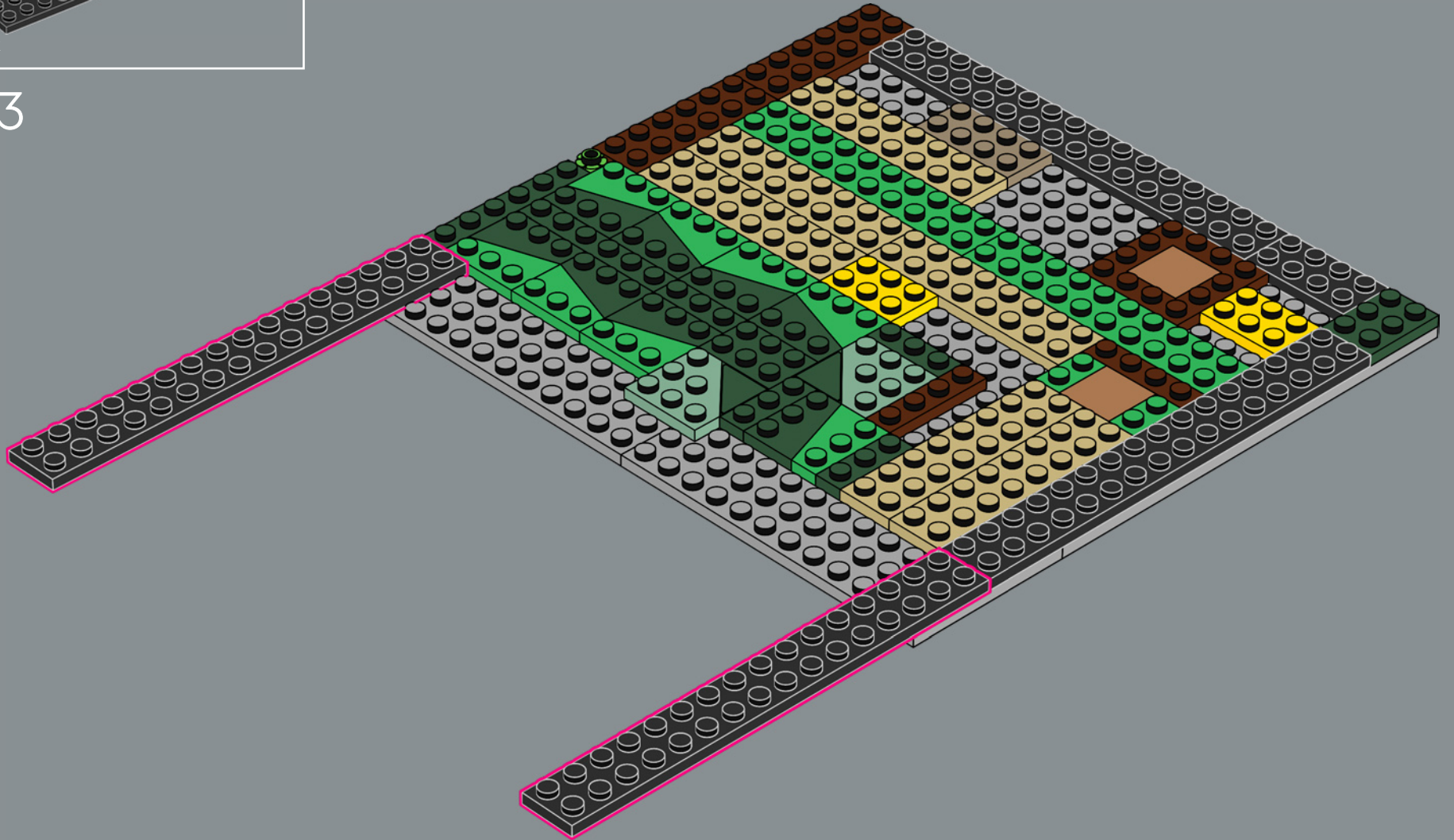

54

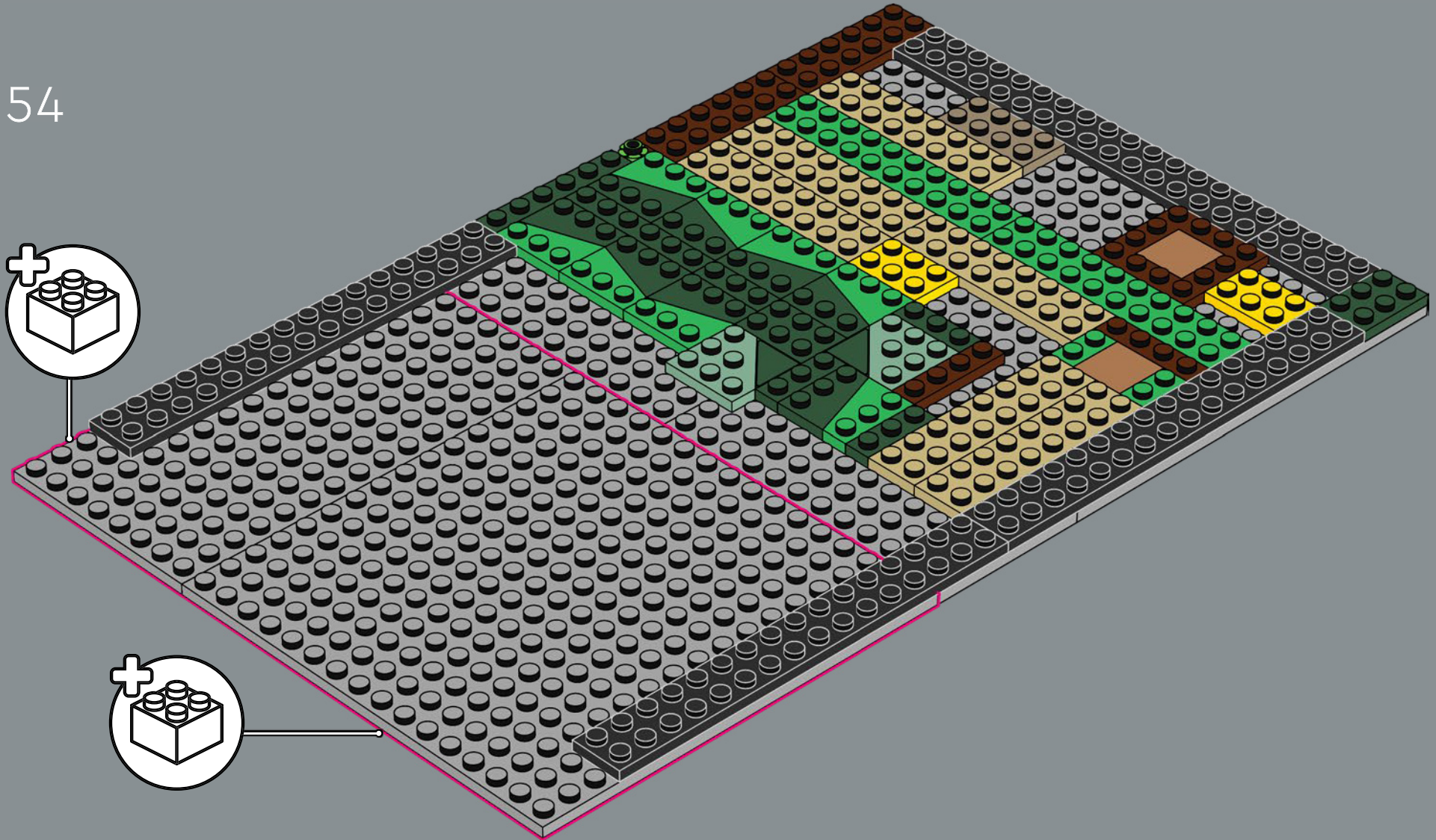

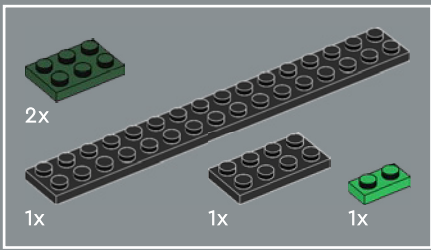

55

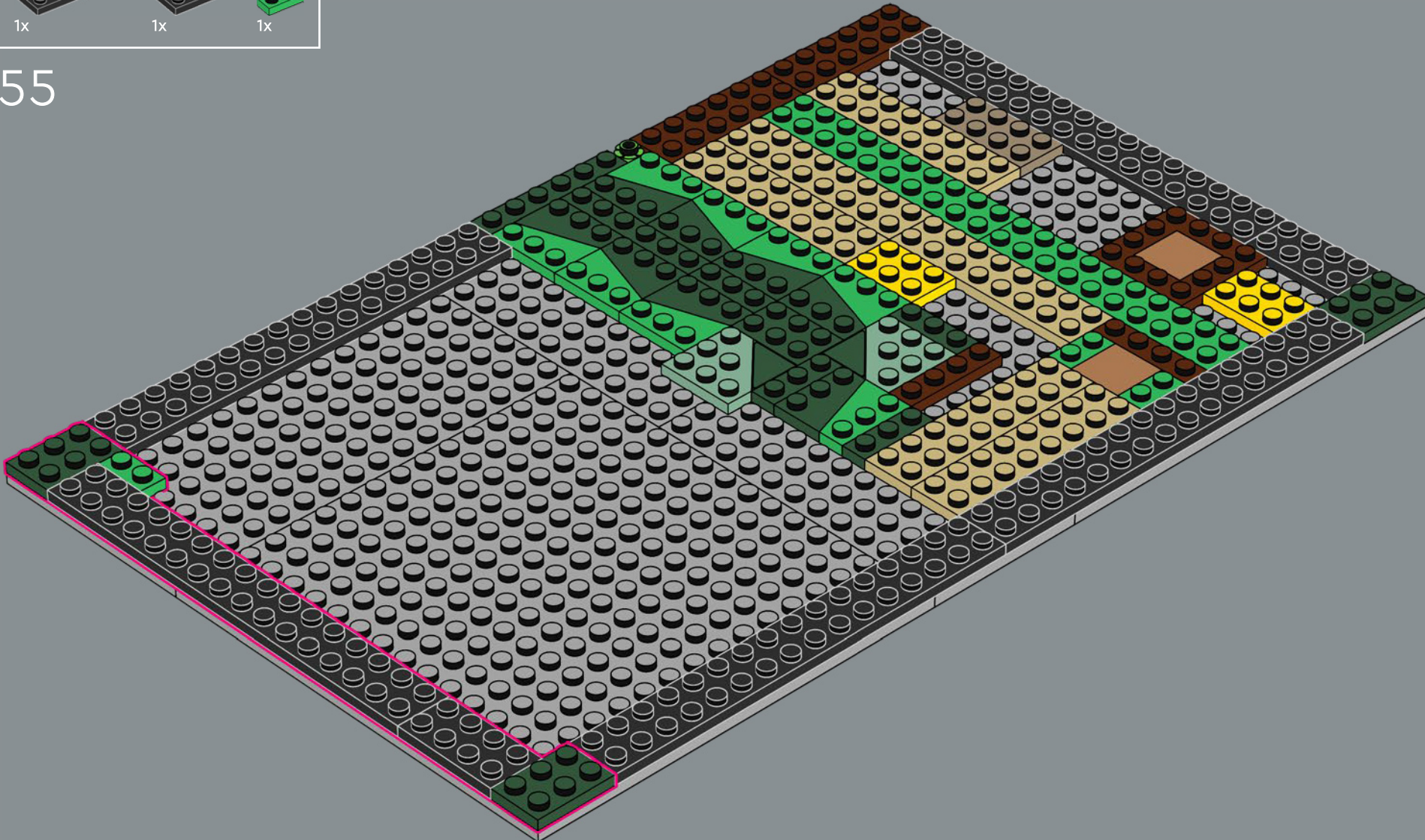

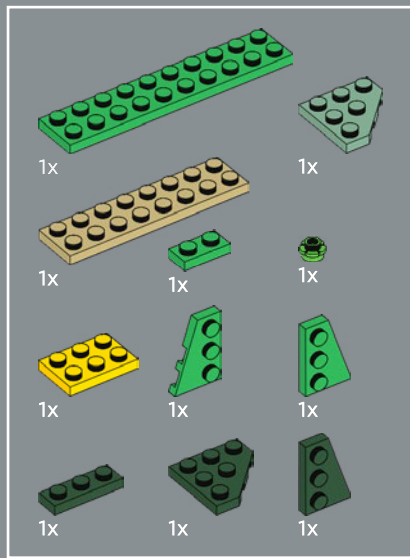

56

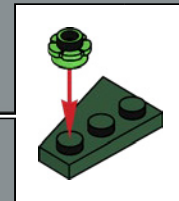
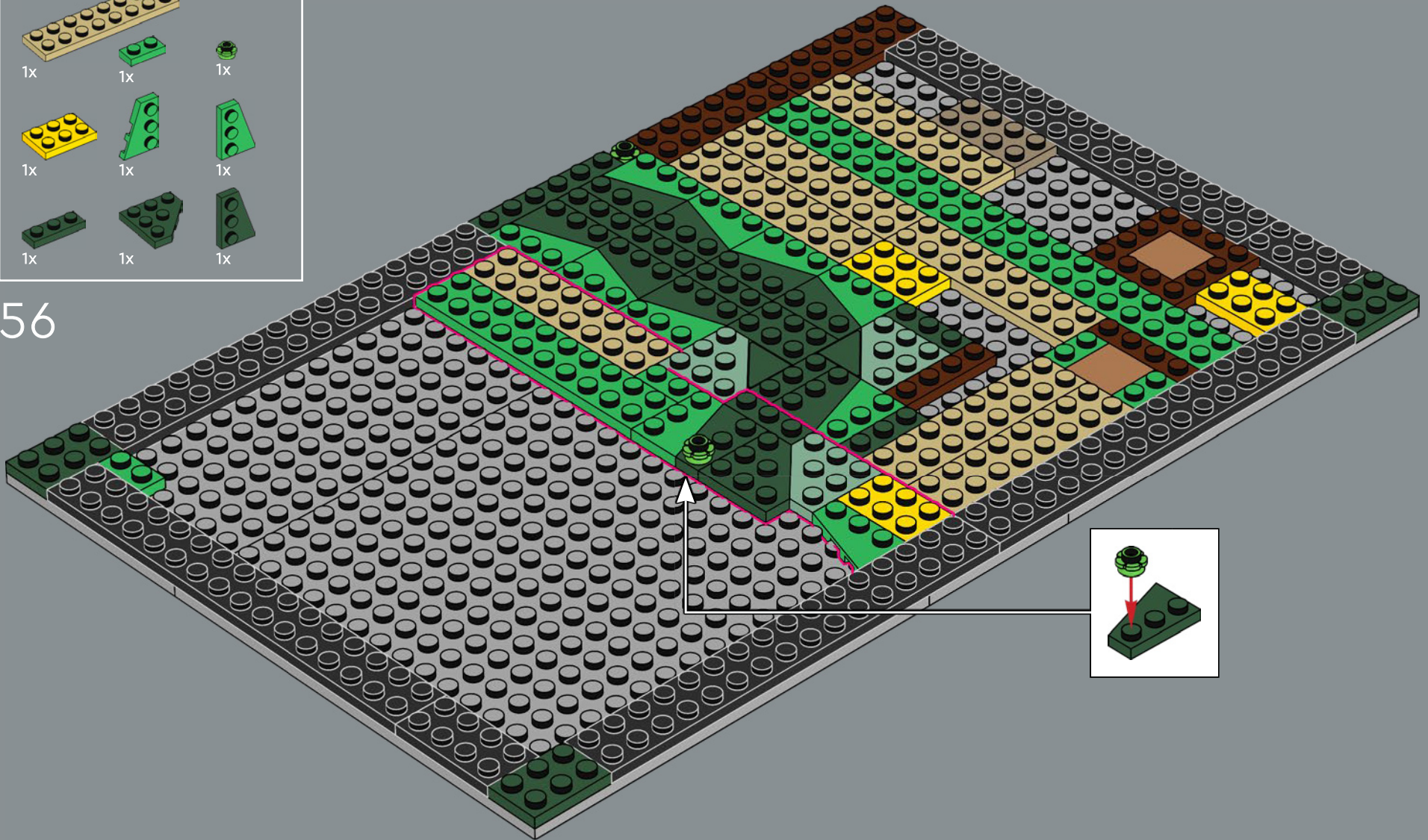

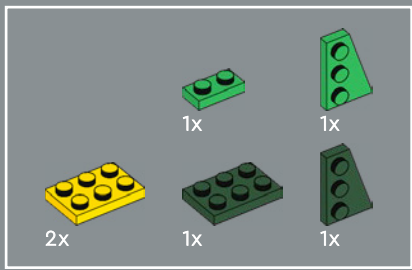

57

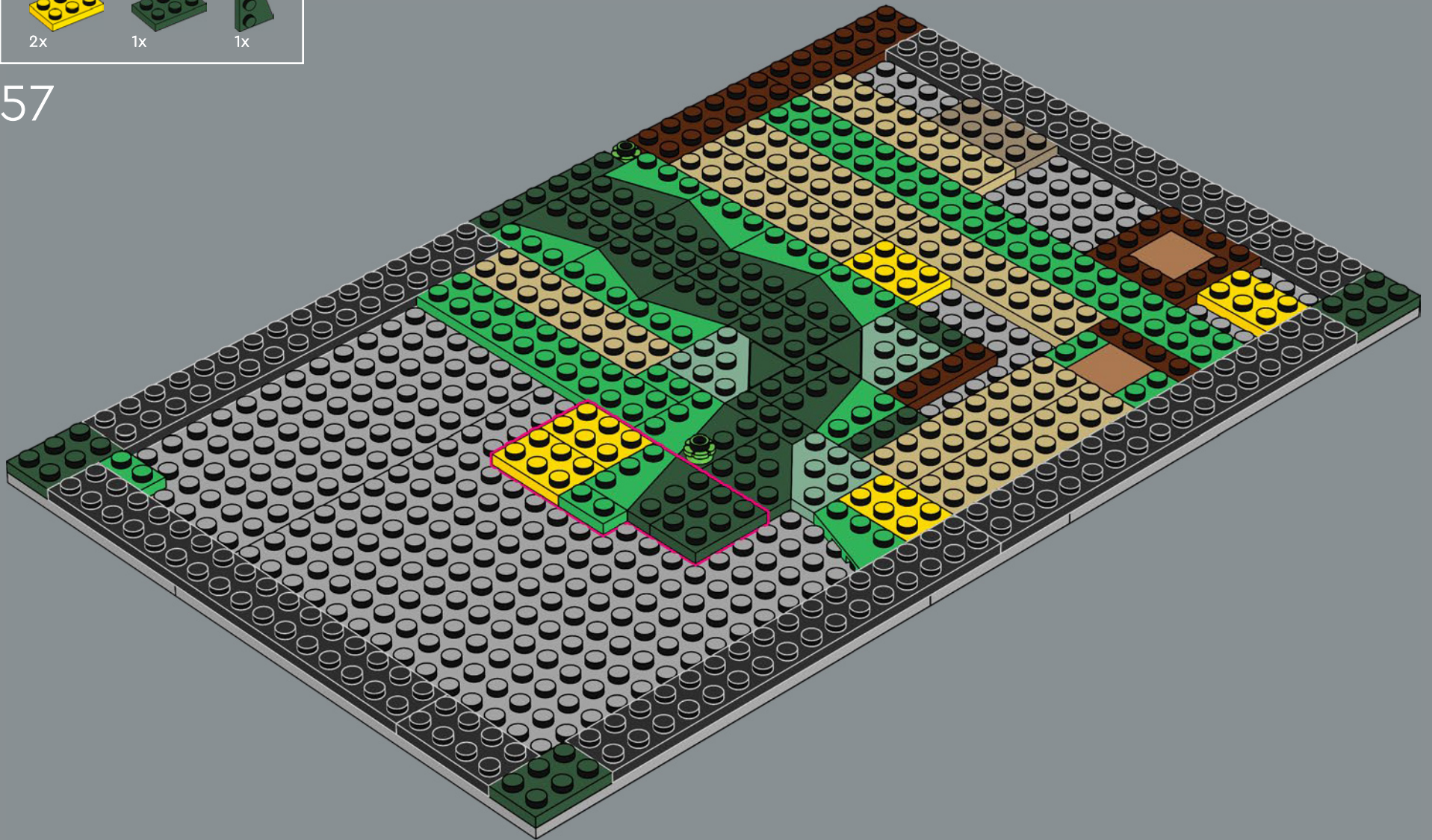

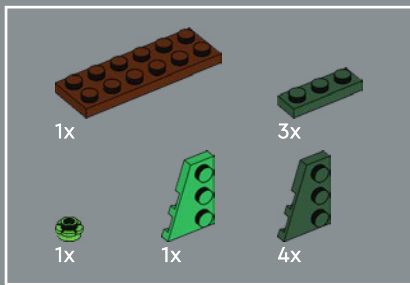

58

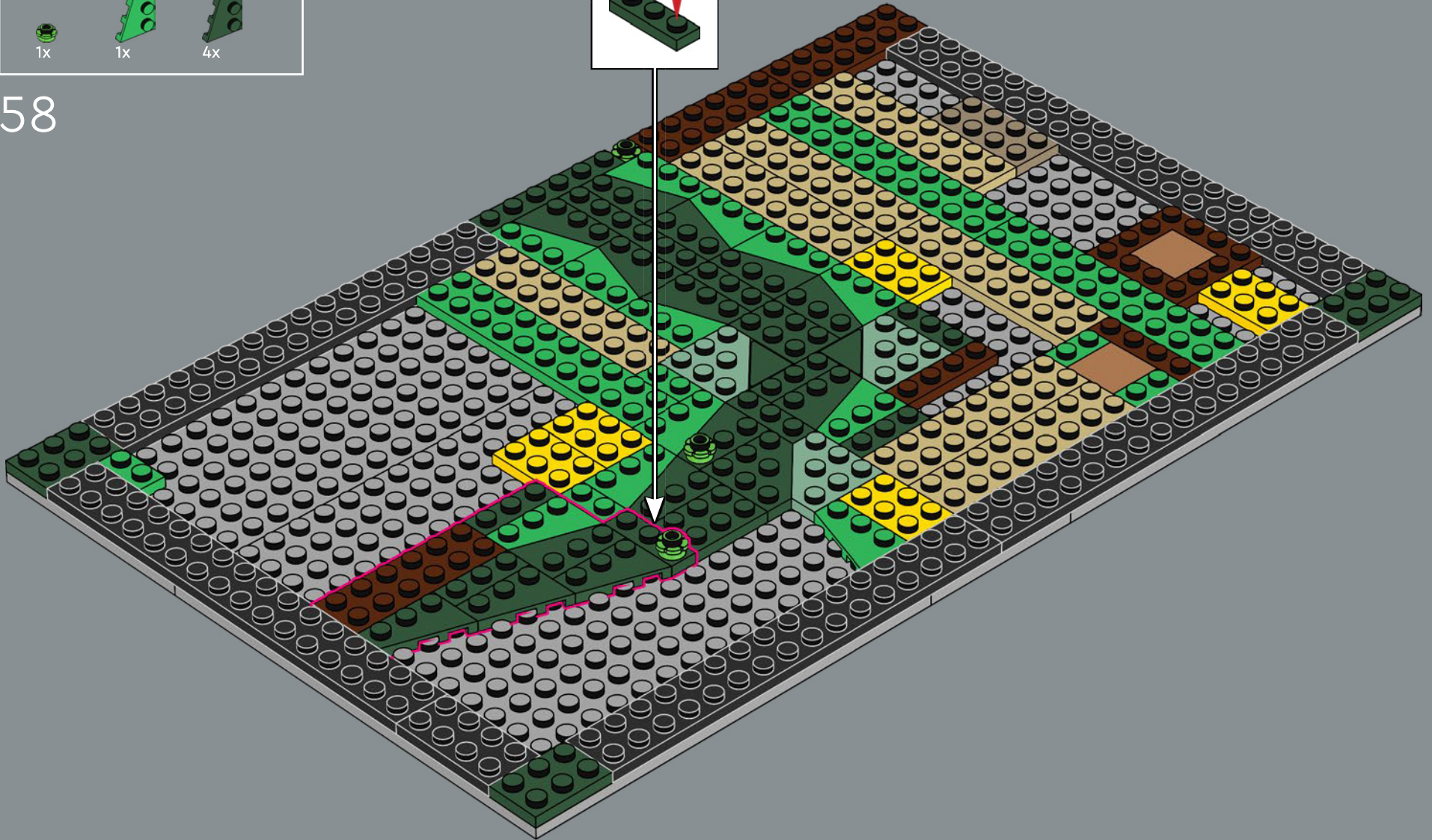
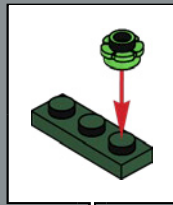

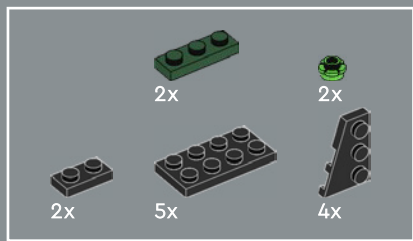

59

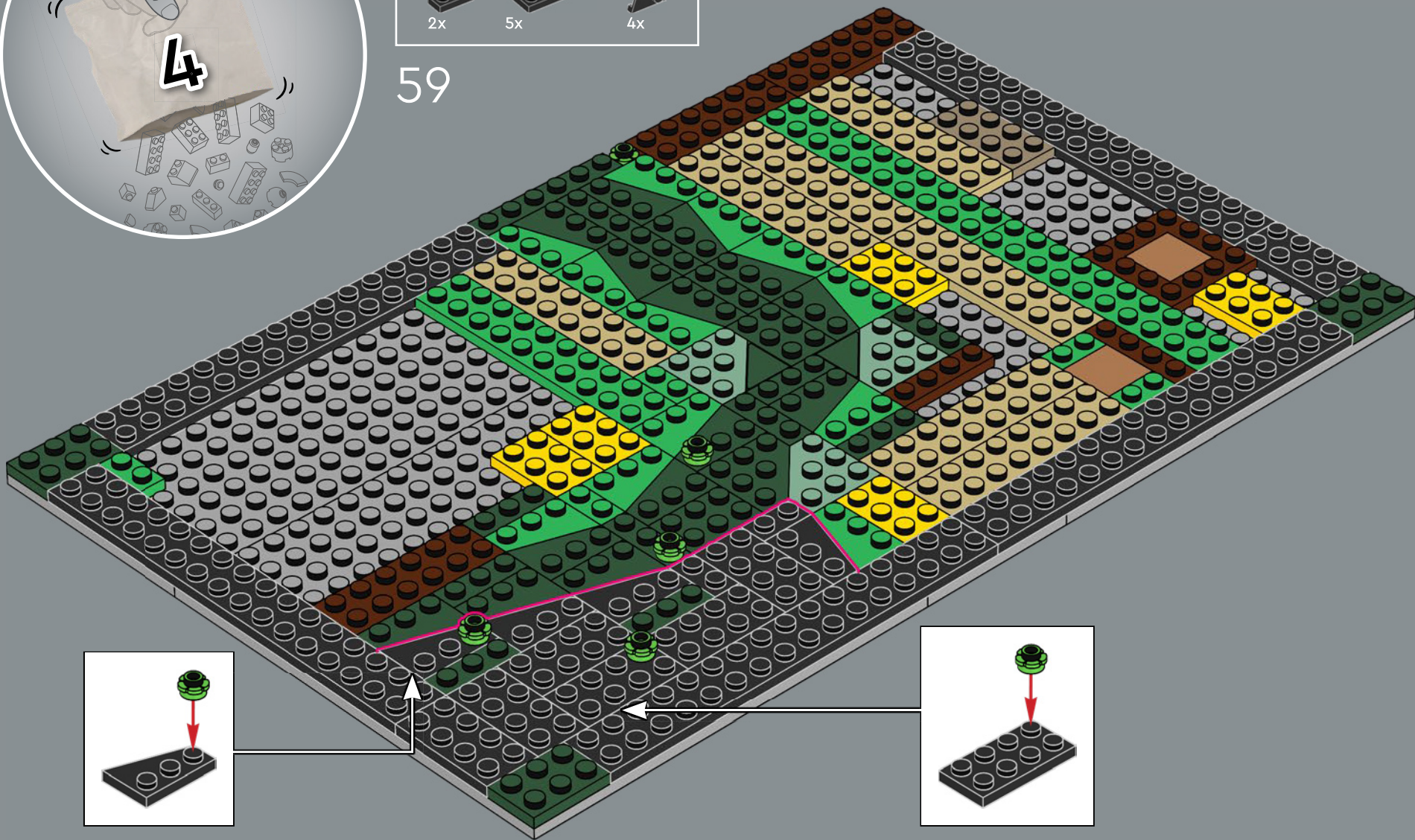

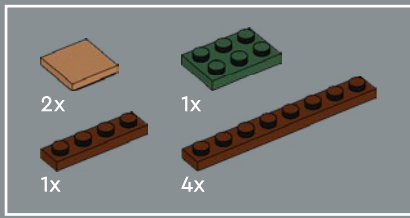

60

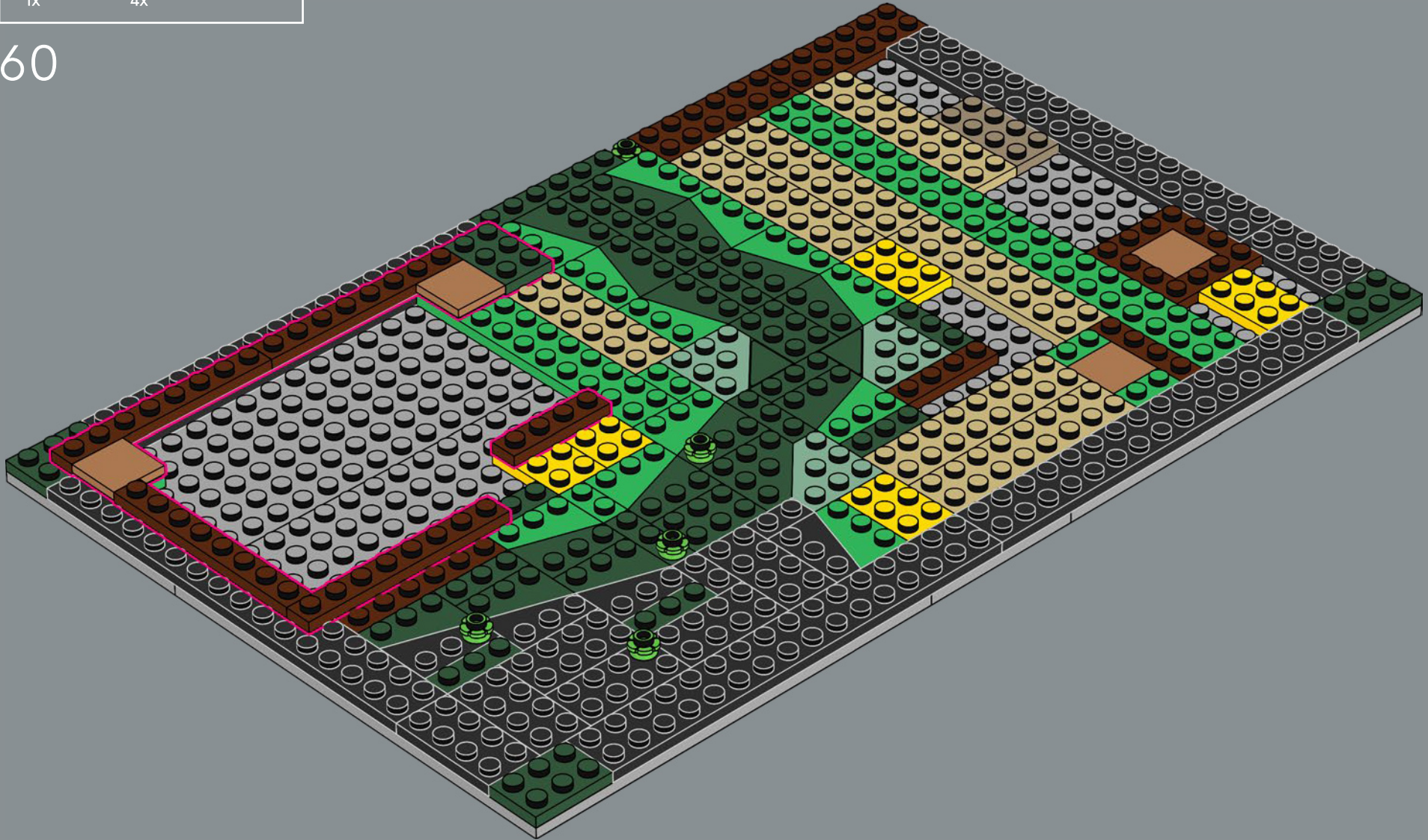

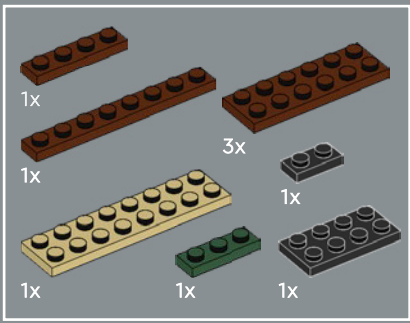

61

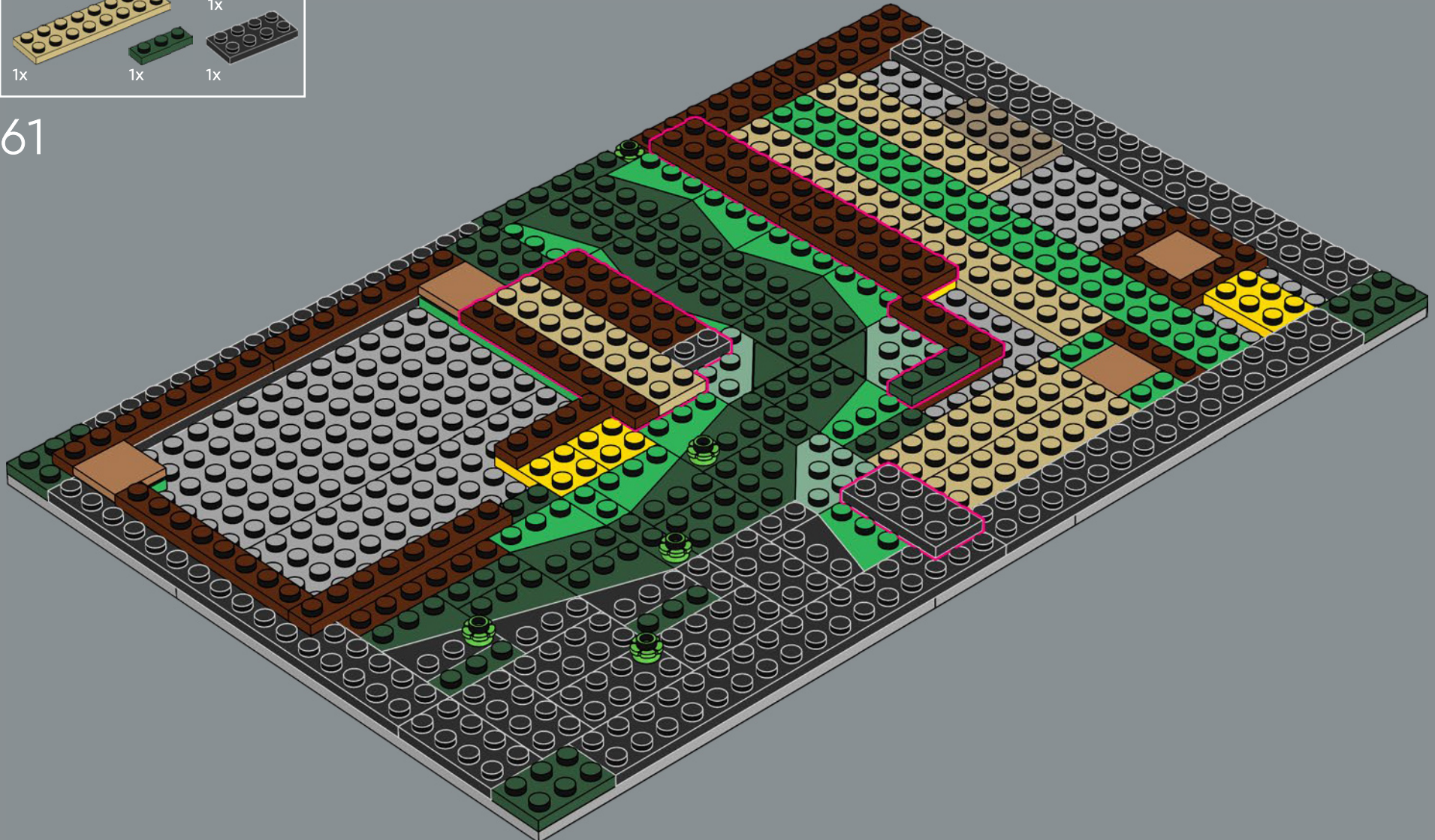

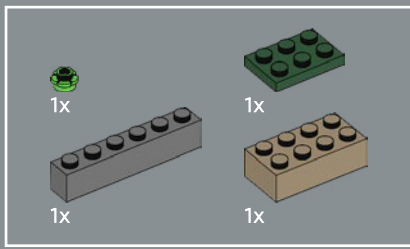

62

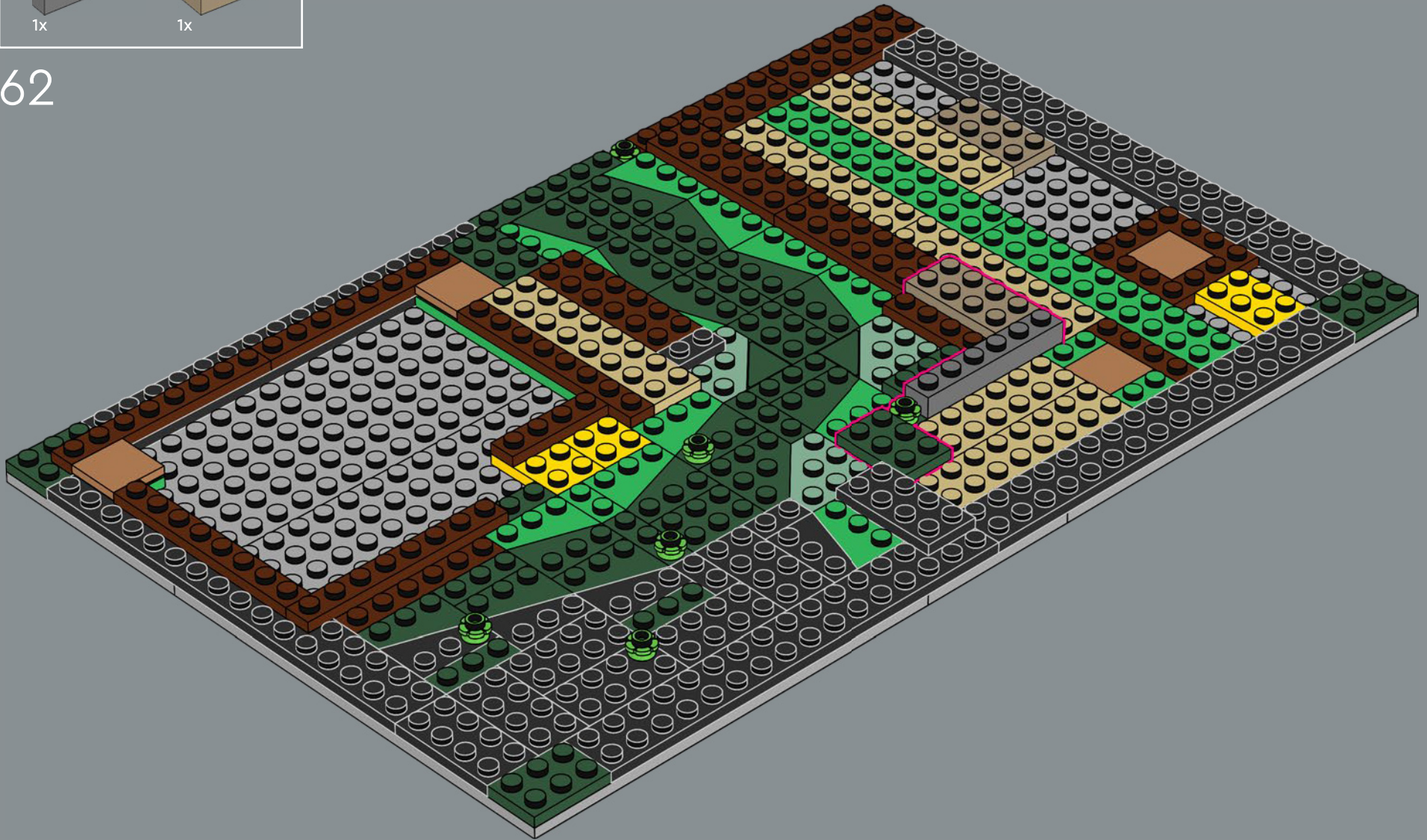

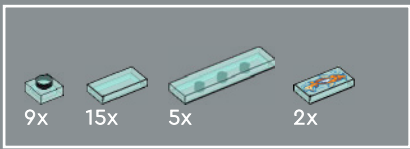

63

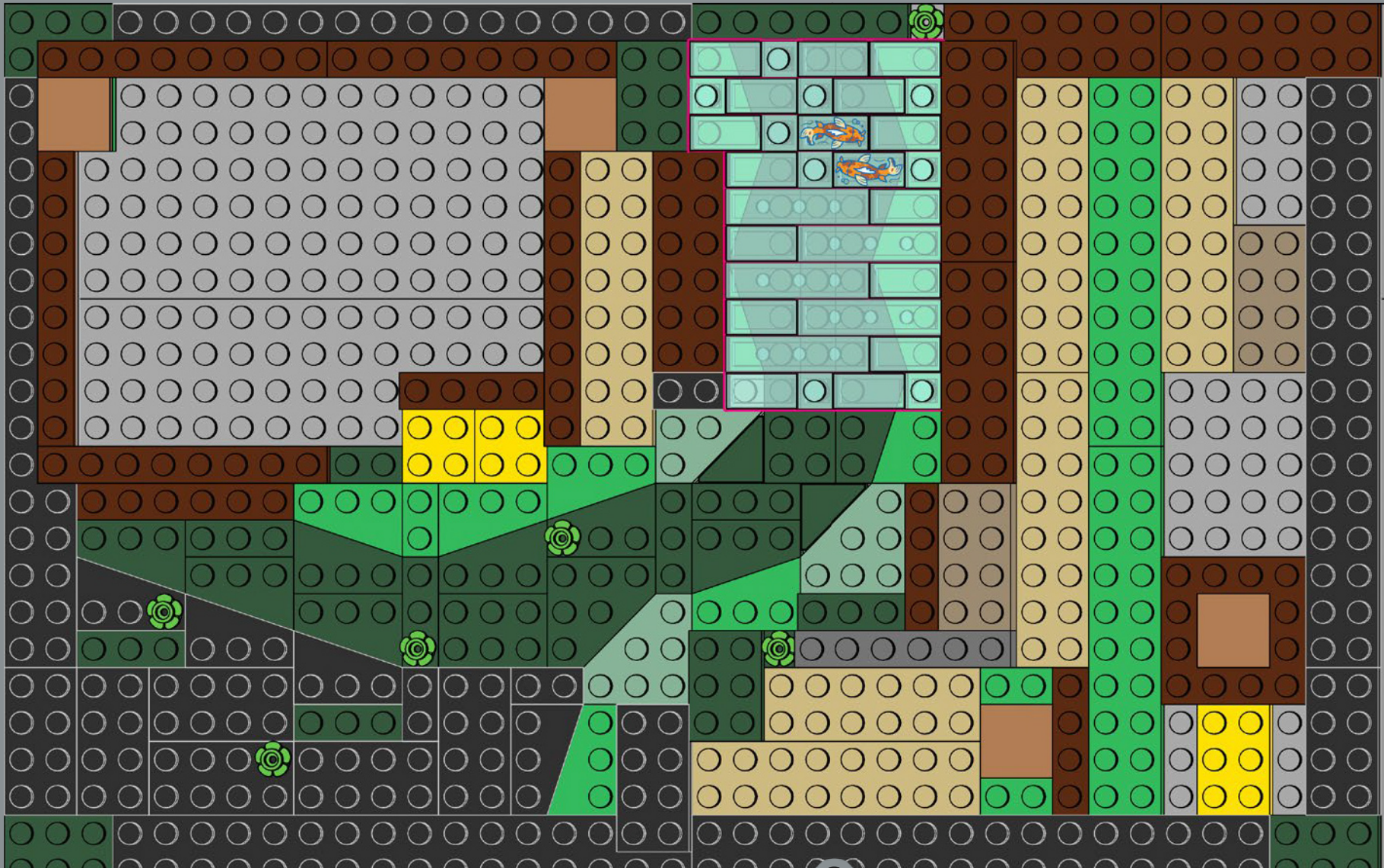



64

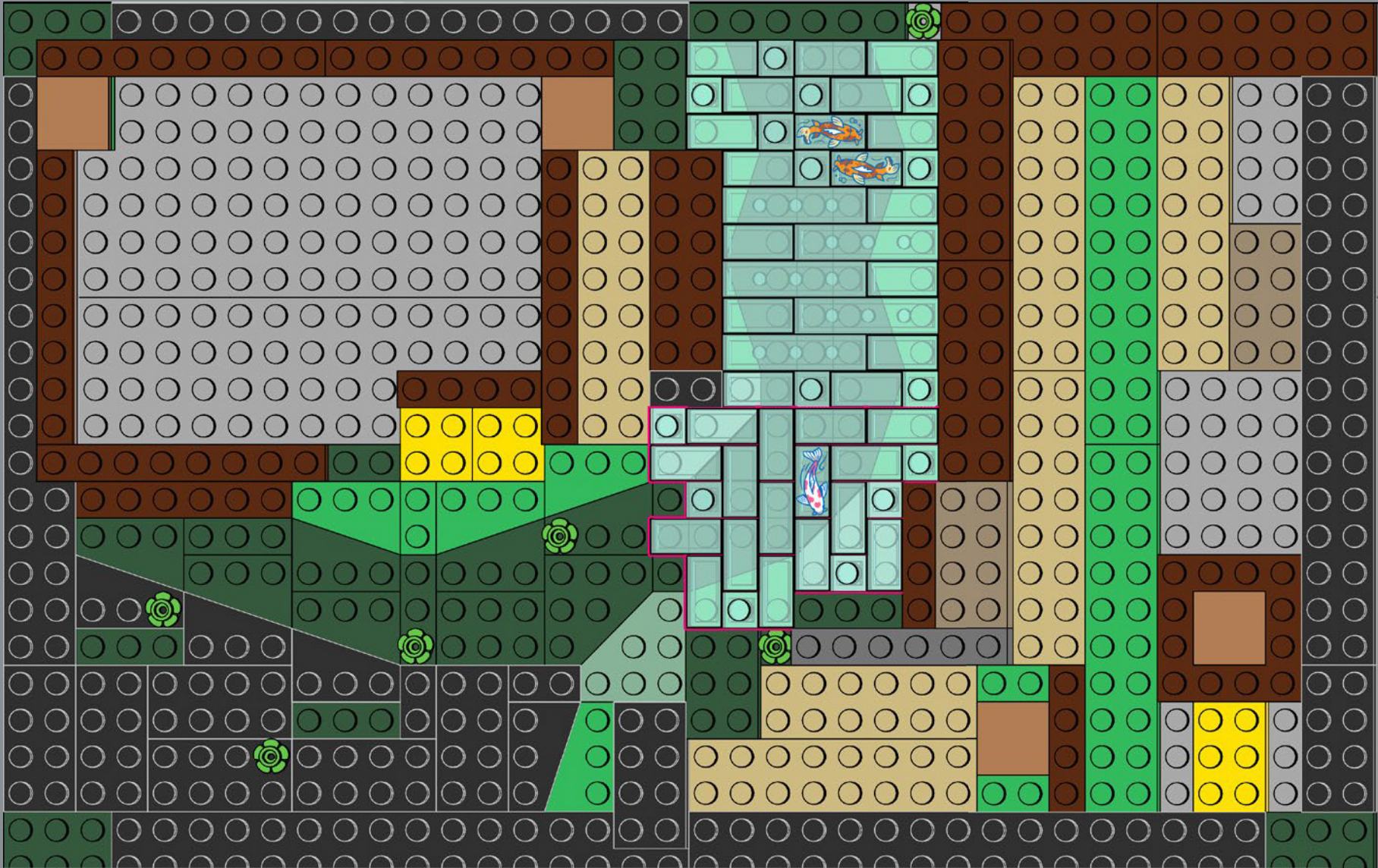

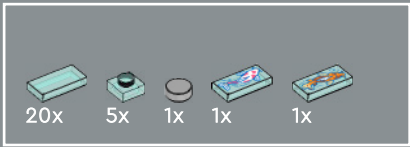

65

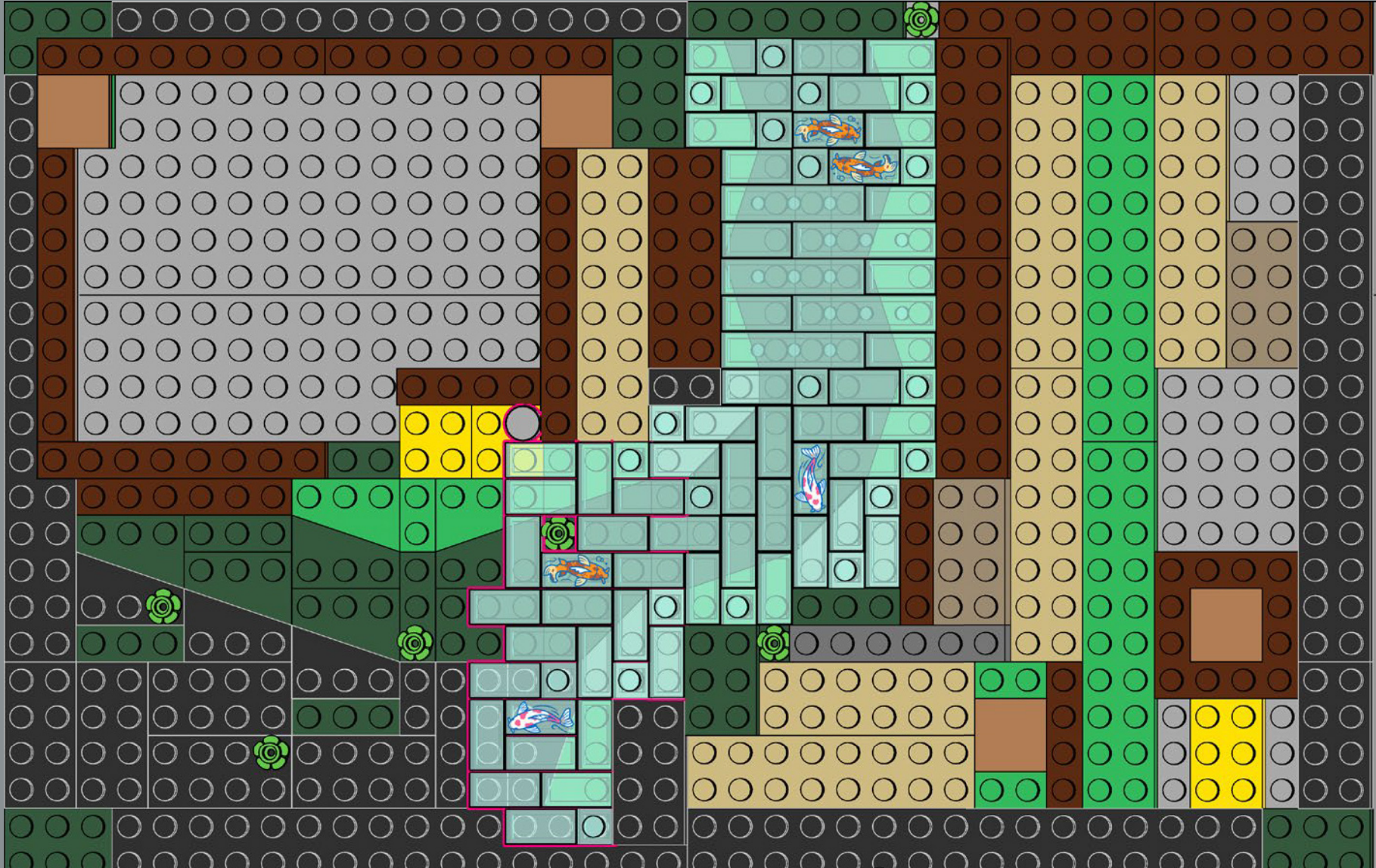

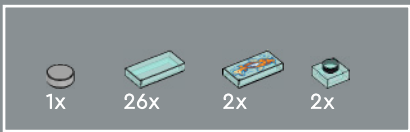

66

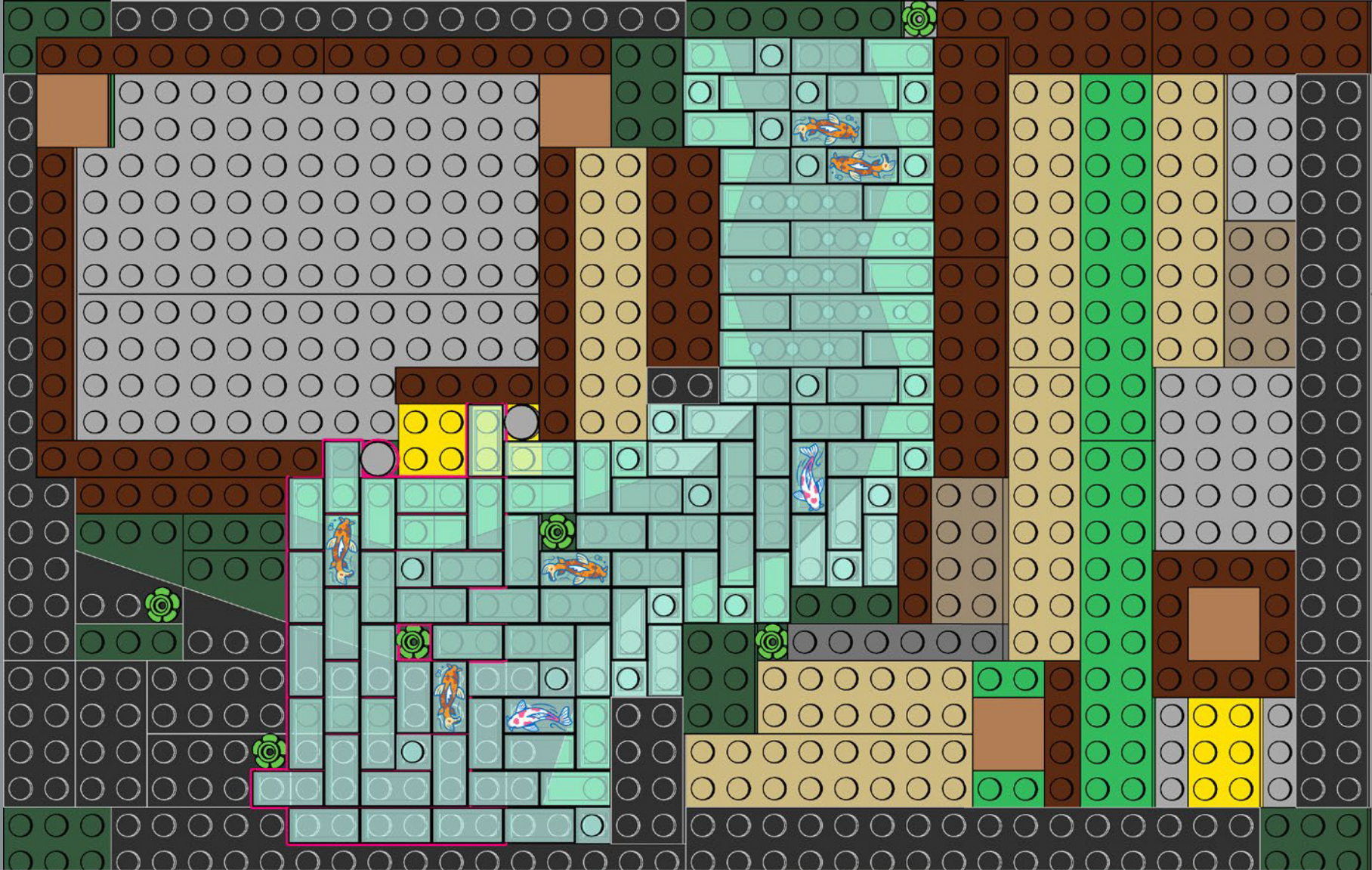

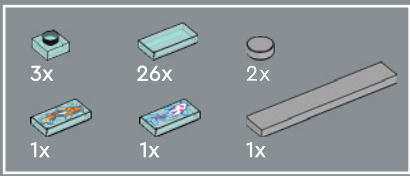

67

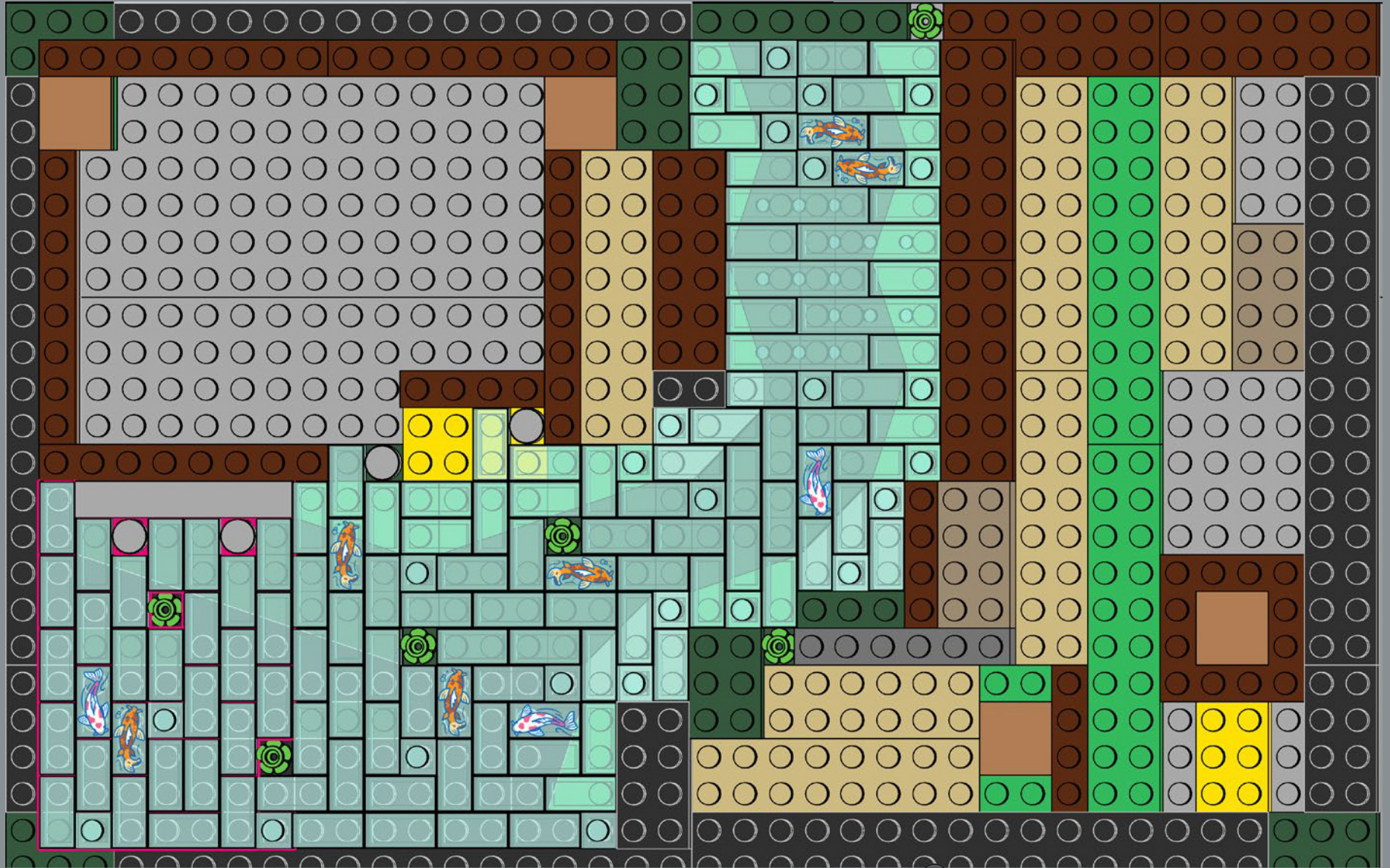



Die Form der Teiche orientiert sich üblicherweise an *kanji* (japanischen Schriftzeichen chinesischer Herkunft), die wichtige Bedeutungen tragen, beispielsweise *kokoro* (Herz).

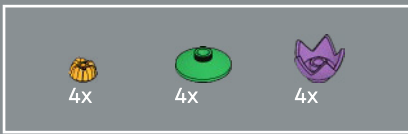

68

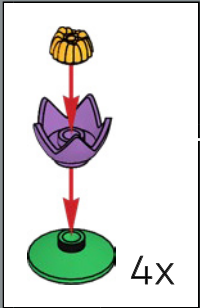

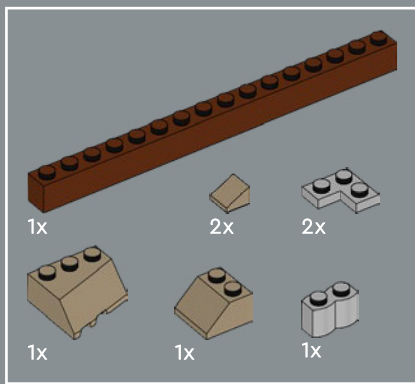

69



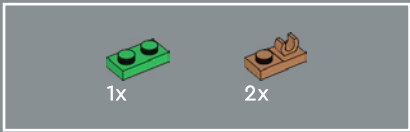

70



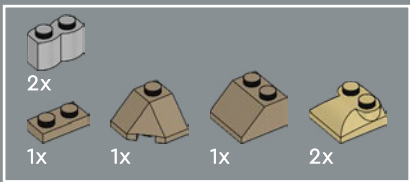

71

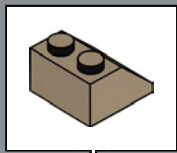
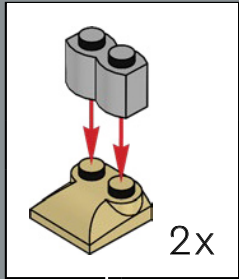

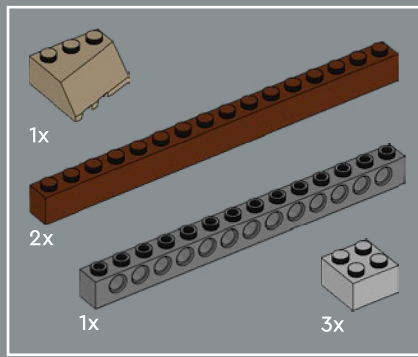

72



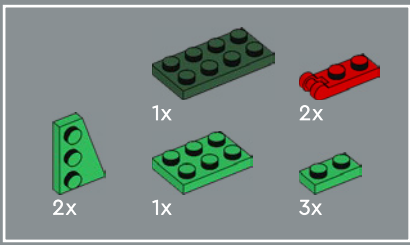

73

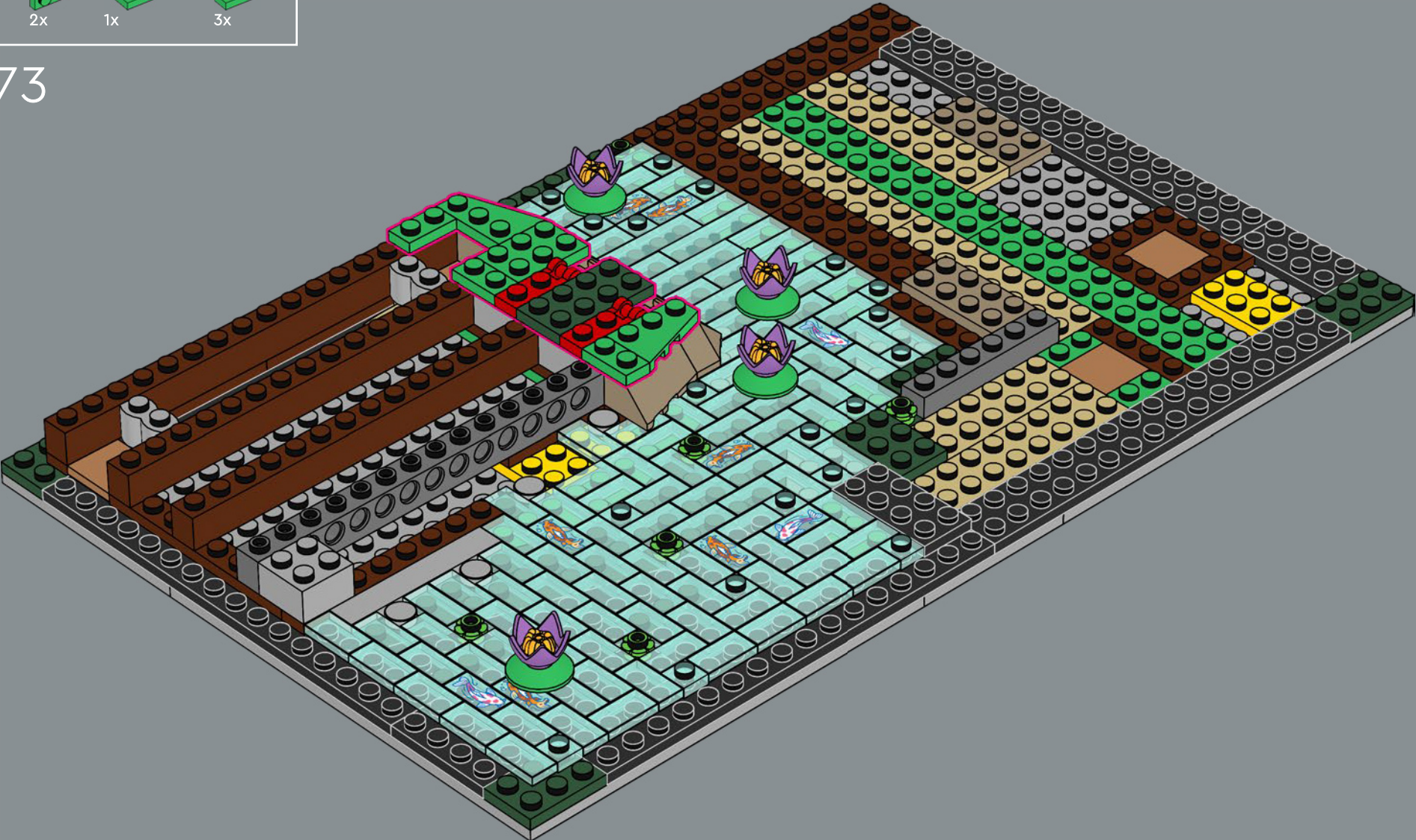

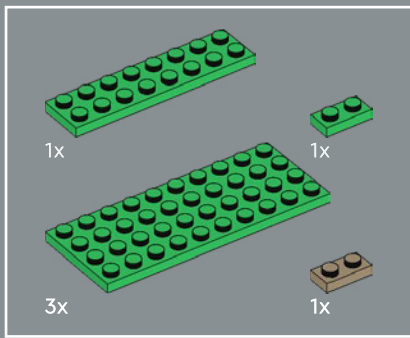

74



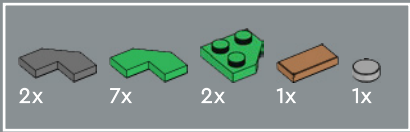

75



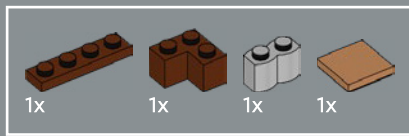

76



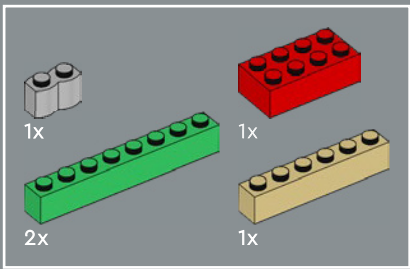

77



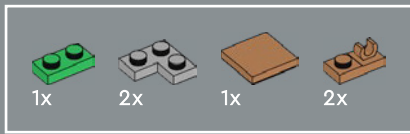

78

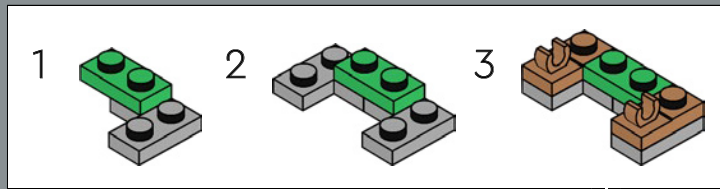

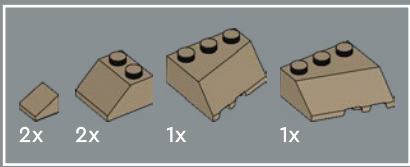

79

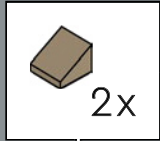

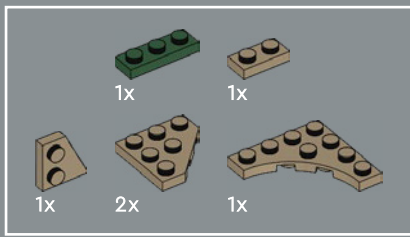

80



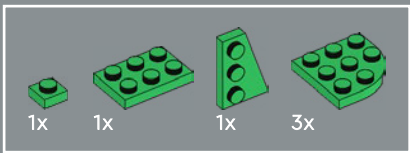

81



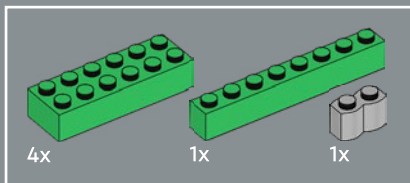

82



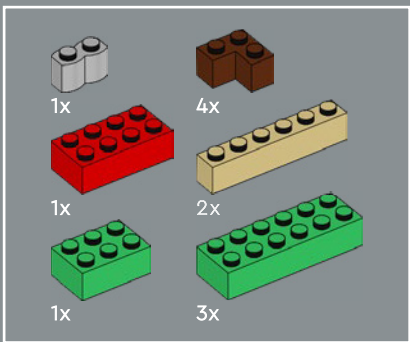

83



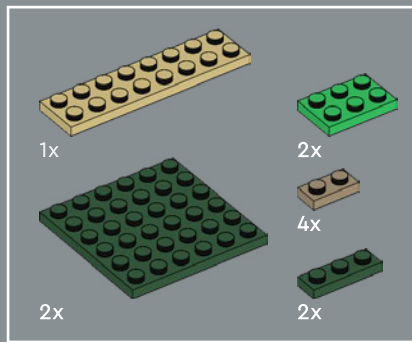

84



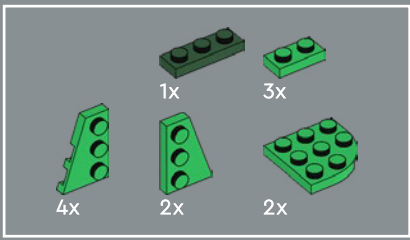

85



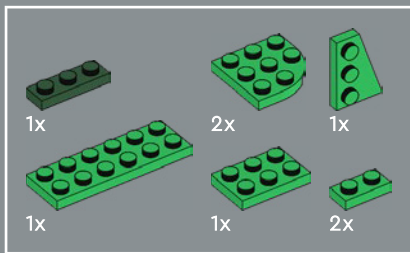

86



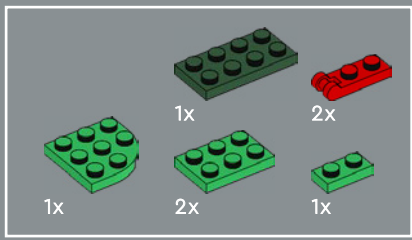

87



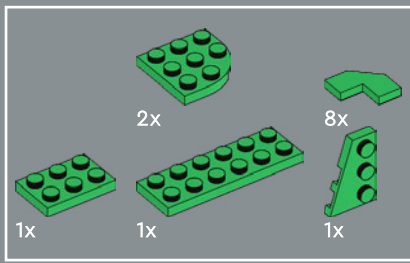

88



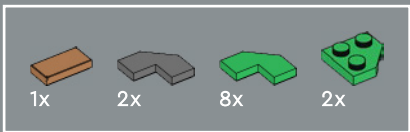

89



Gärten der Stille sind Oasen, die mystische oder mythische Berge, Schildkröten oder Kraniche und somit auch Langlebigkeit symbolisieren.

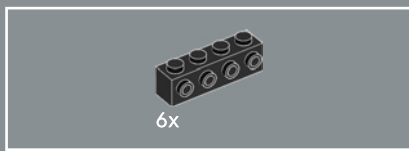

90



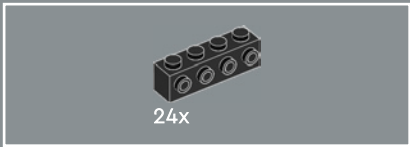

91



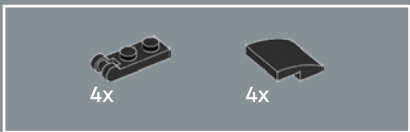

92

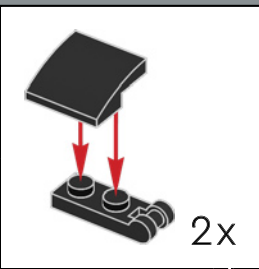
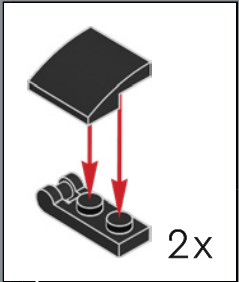

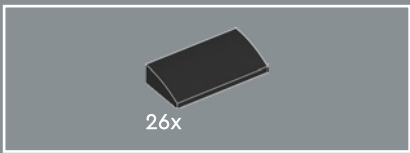

93



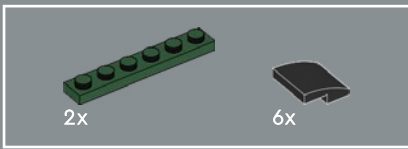

94

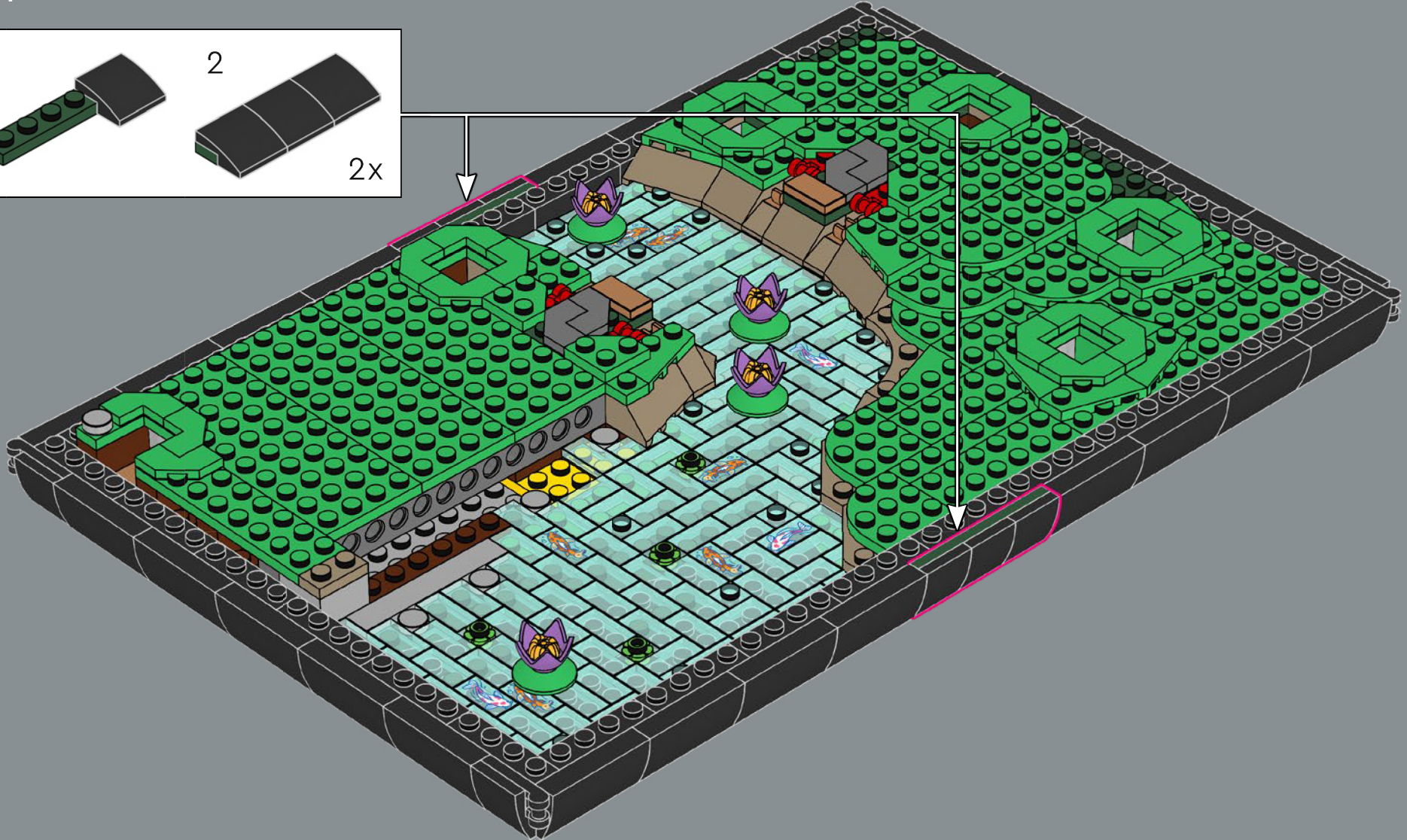
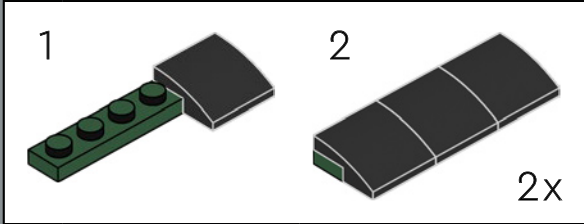

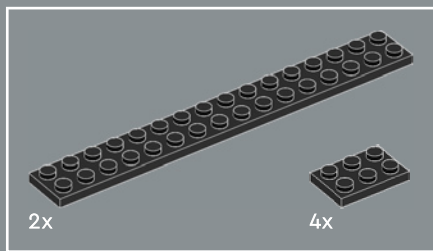

95



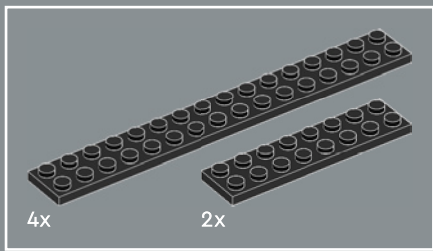

96



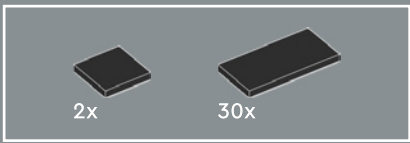

Kommt dir das Design des Bodenrahmens dieses Modells bekannt vor? Wir haben hier das Blumentopfdesign vom LEGO® Icons Bonsai Baum (10281) übernommen, um eine ähnliche Optik und Haptik zu erzeugen.

97

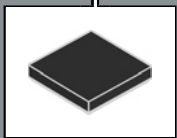
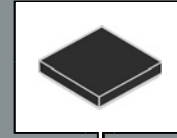

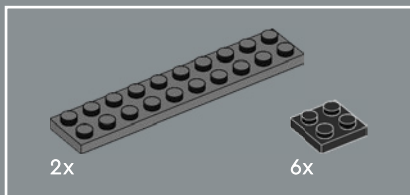

98

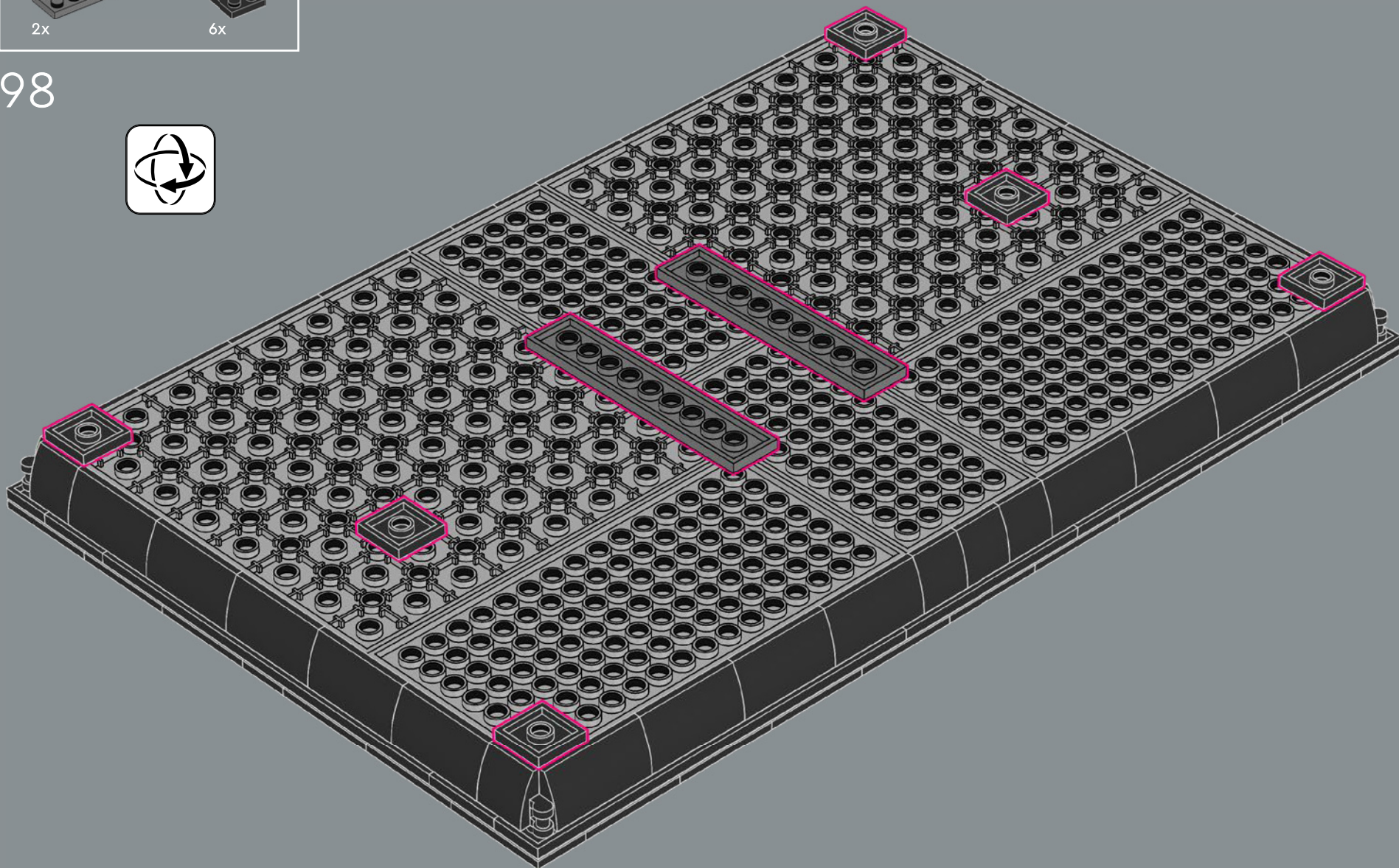



99

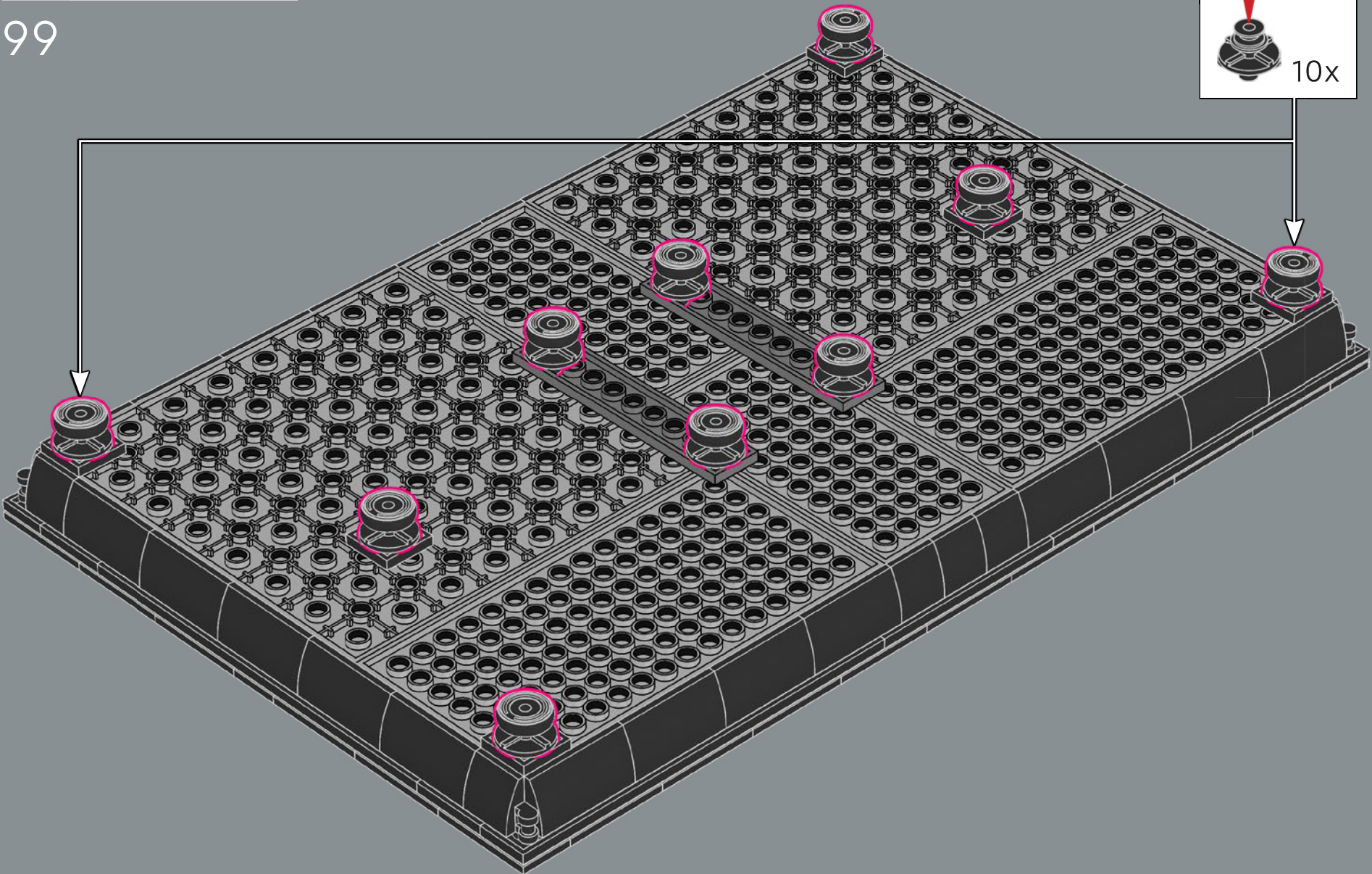
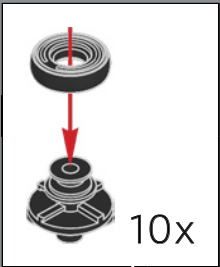



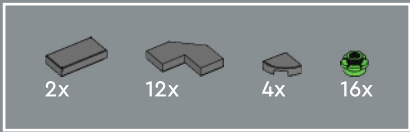

100

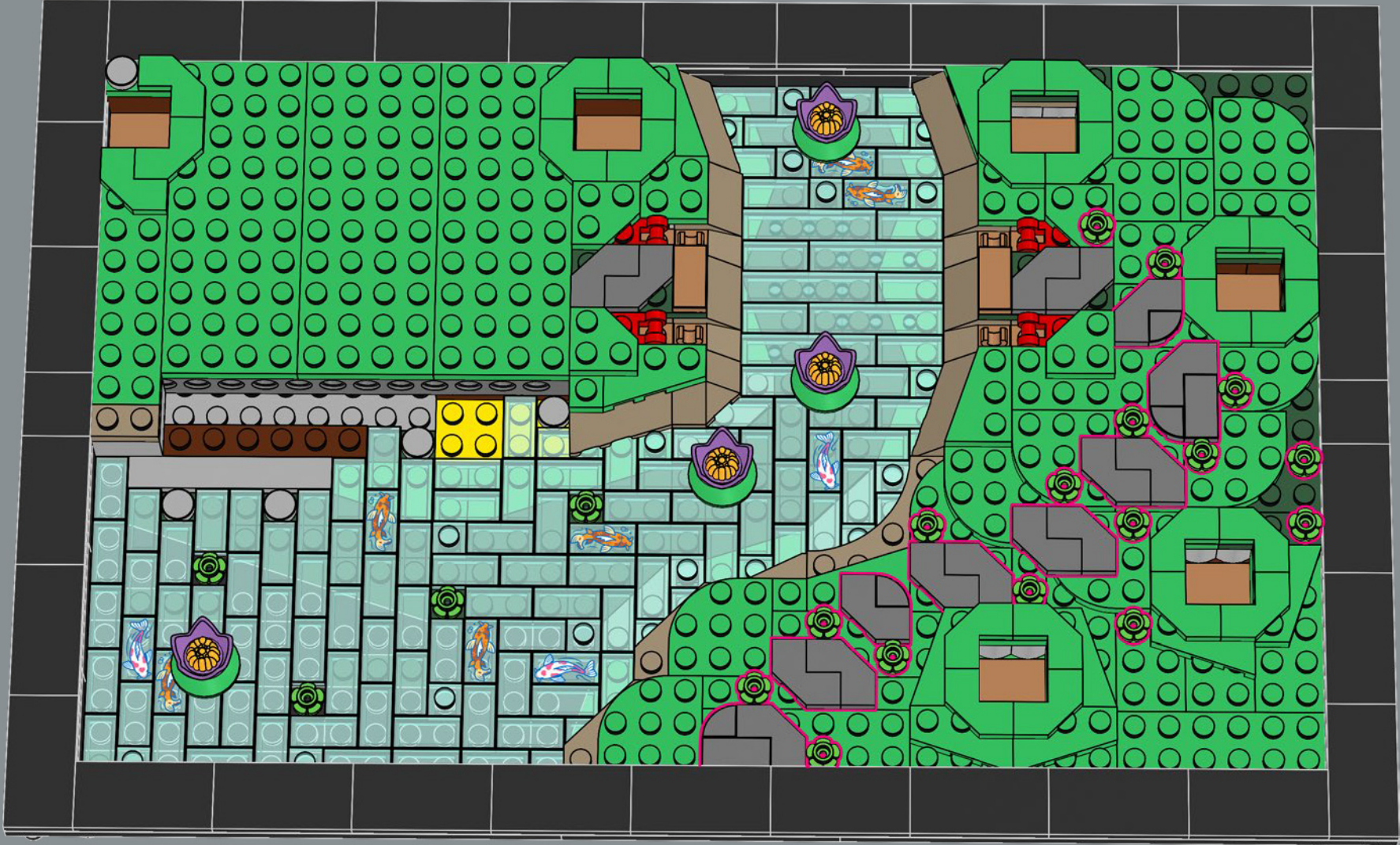

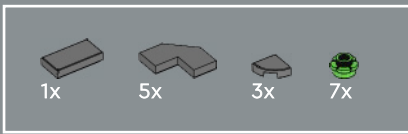

Schlängelnde Pfade laden dich dazu ein, den Garten oder vielleicht auch andere Dinge aus unterschiedlichen Blickwinkeln zu betrachten.

101

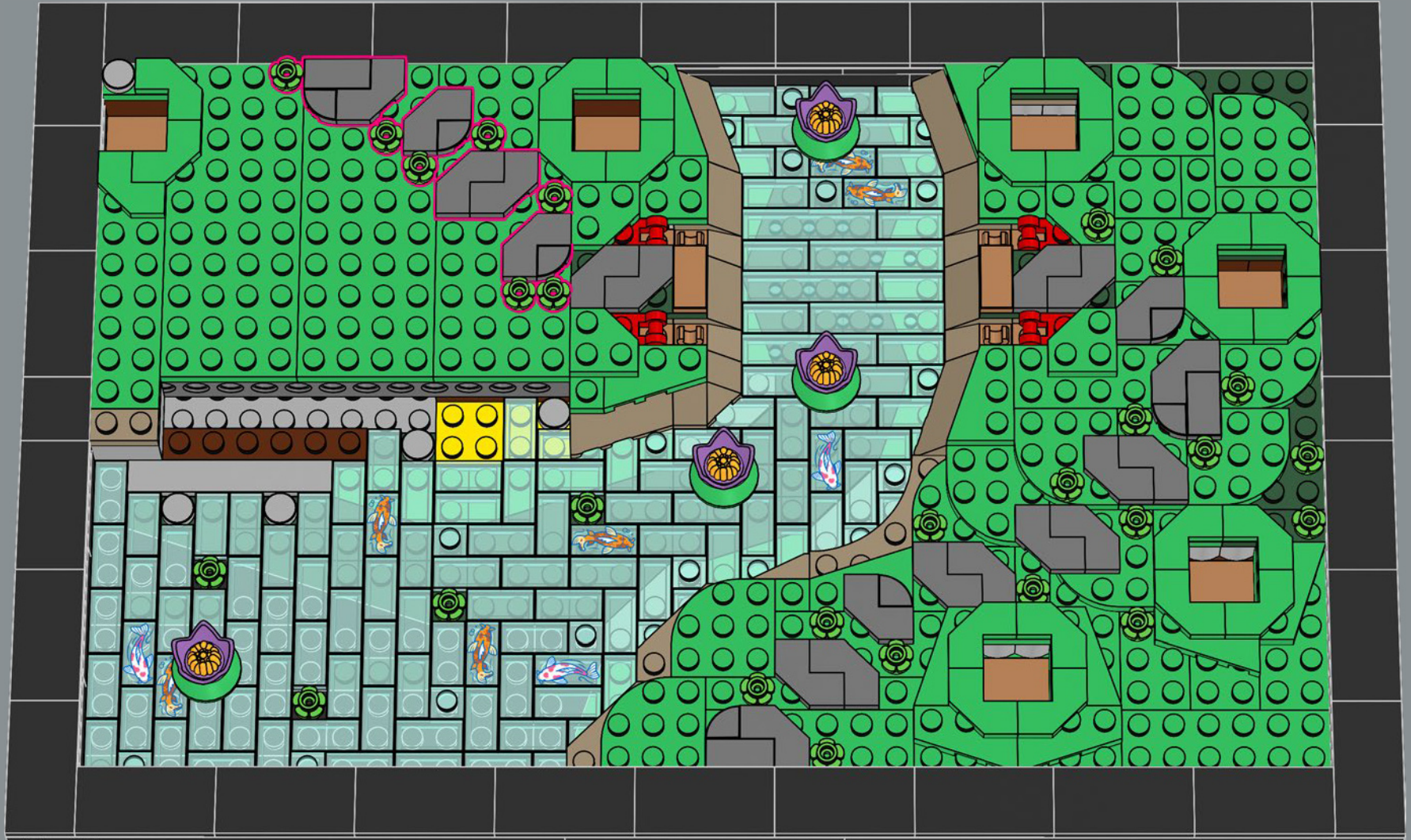

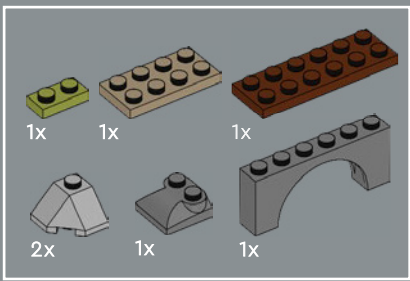

102

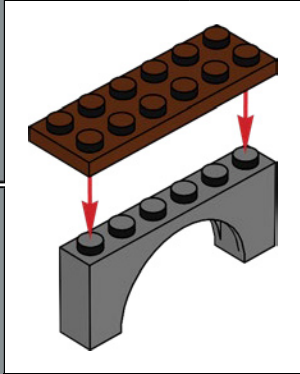

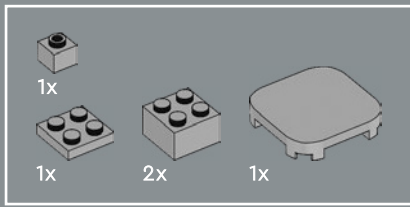

103



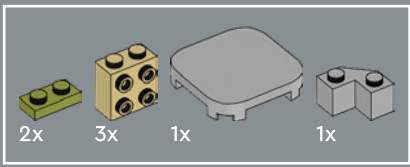

104

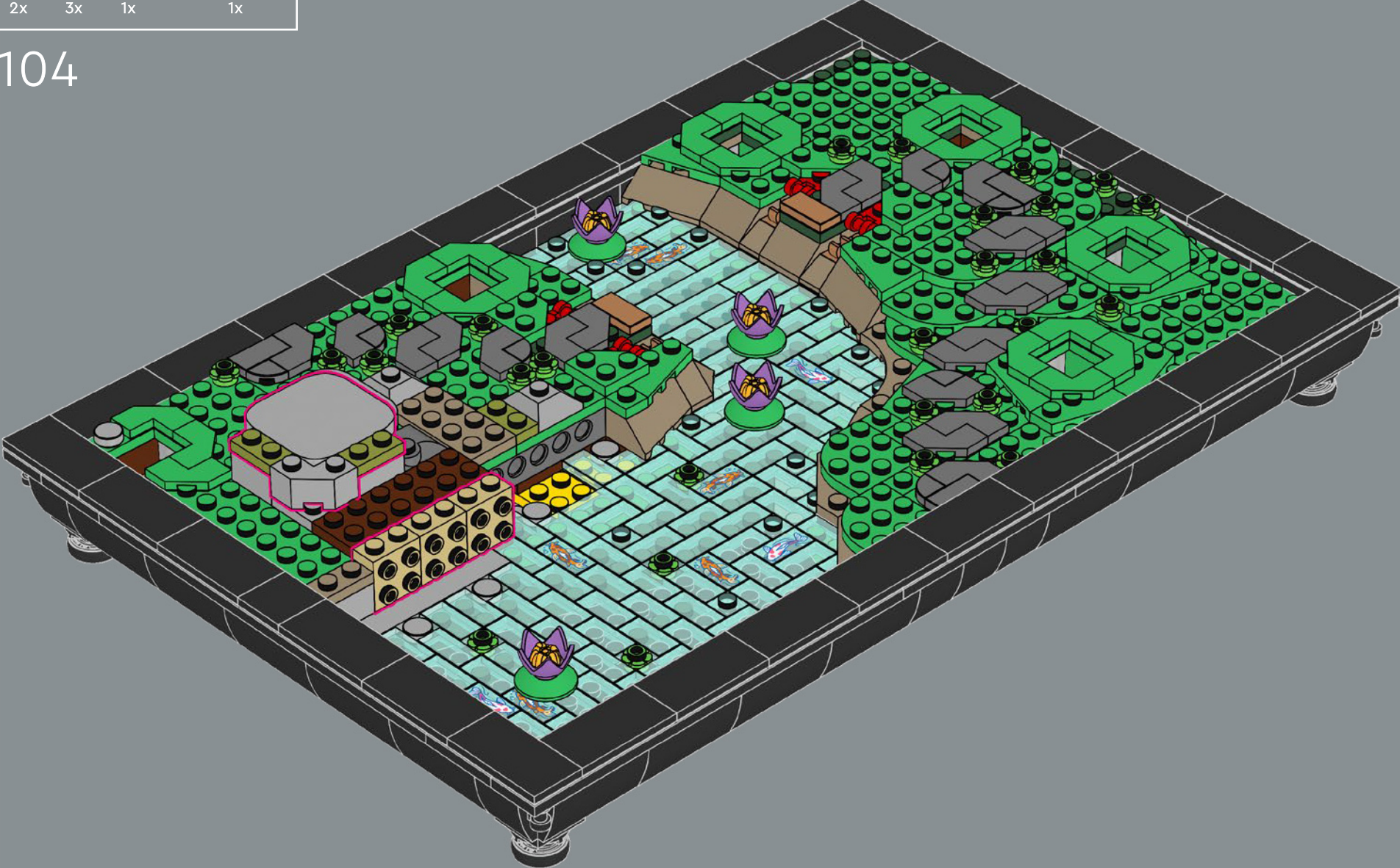

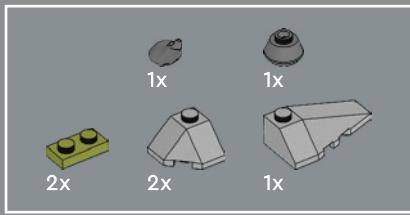

105

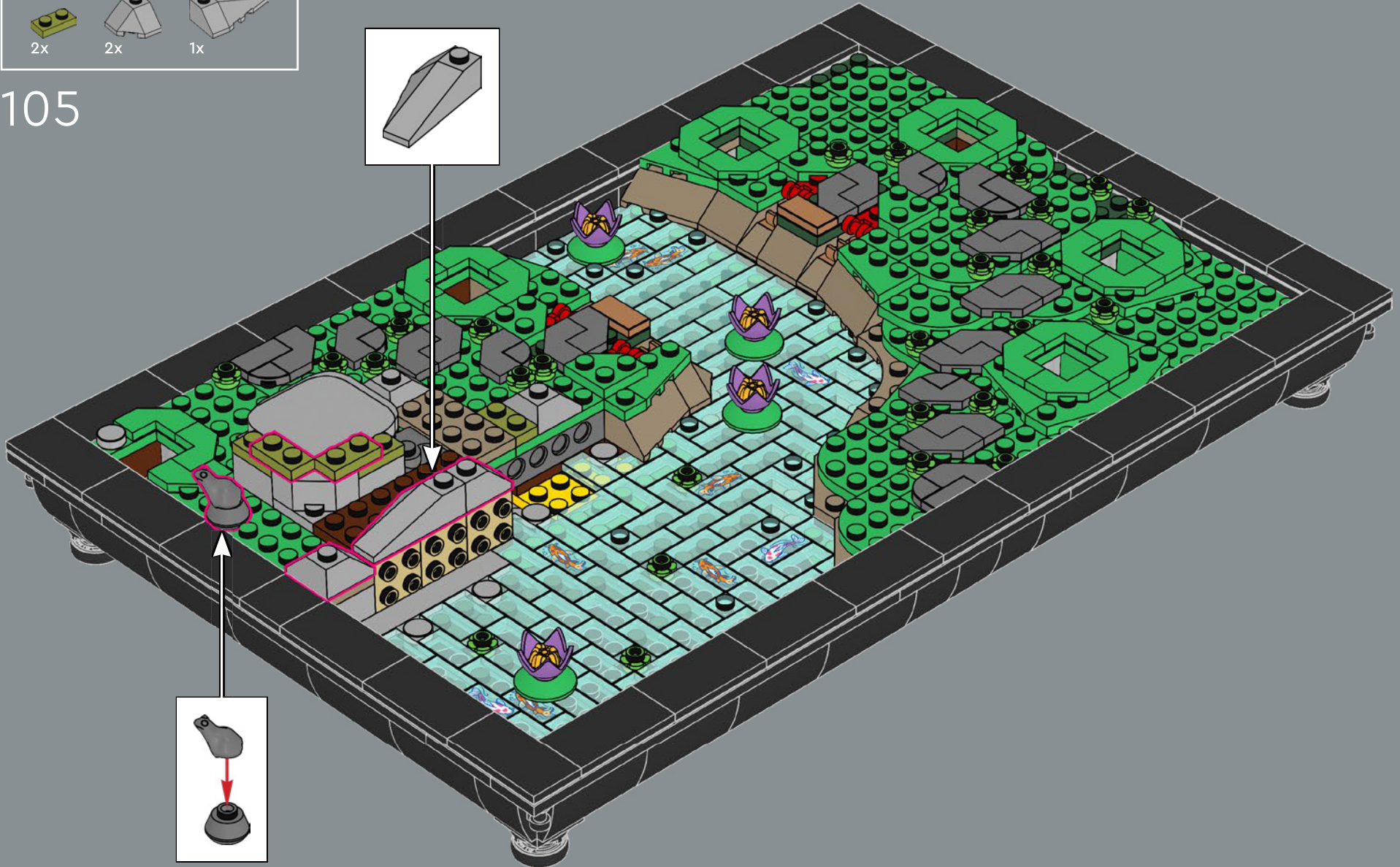
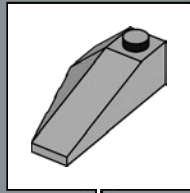

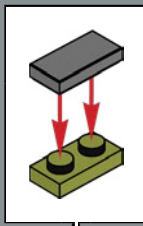
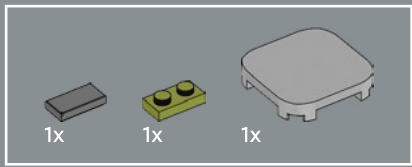

106



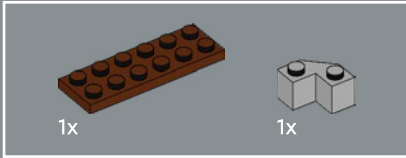
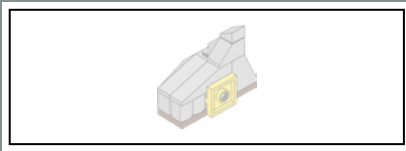

107

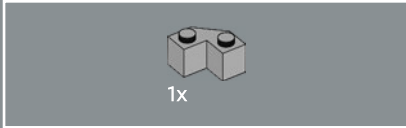
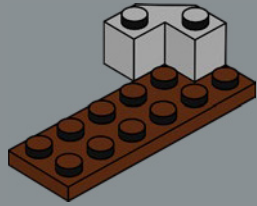

108

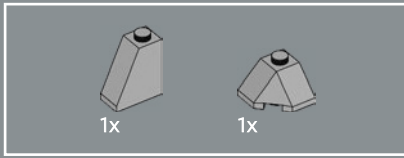
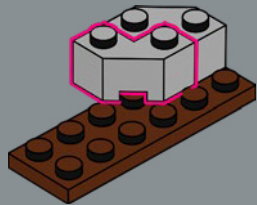

109

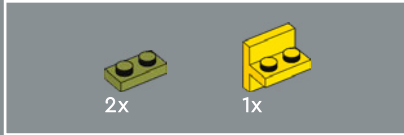
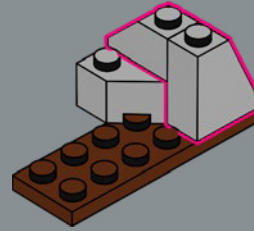

110

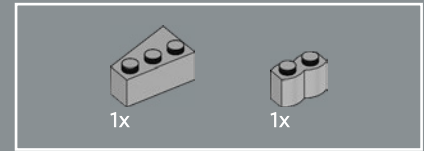
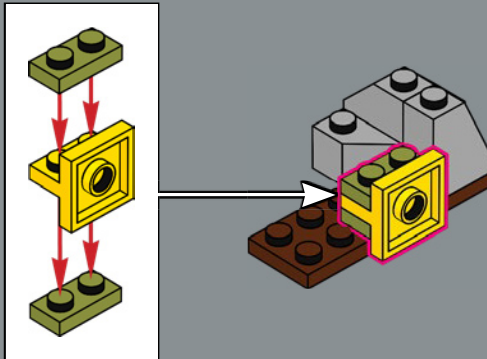

111

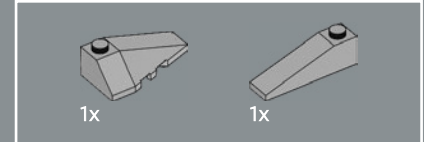
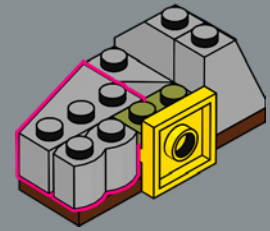

112

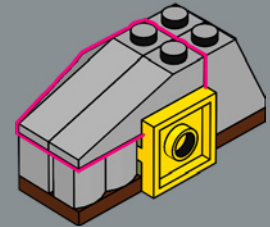

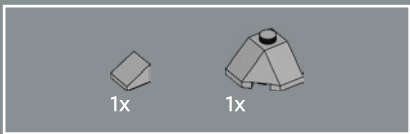

113

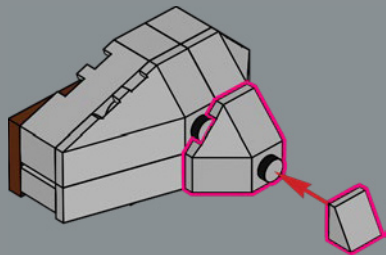

114



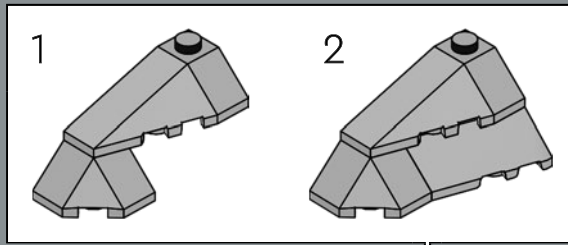
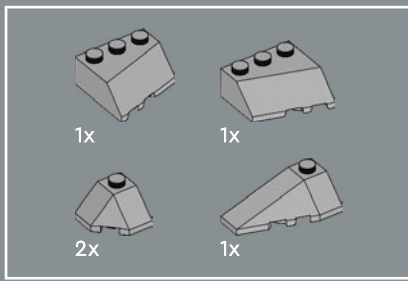

115

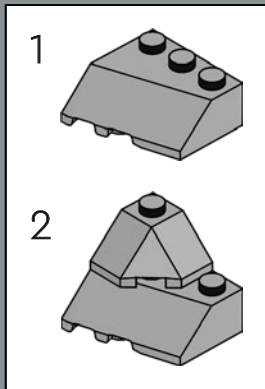

Steine, Felsen und Sand verleihen der Anlage häufig eine tiefere Bedeutung.



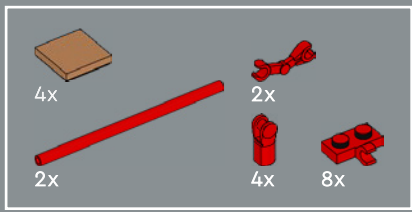

116

1

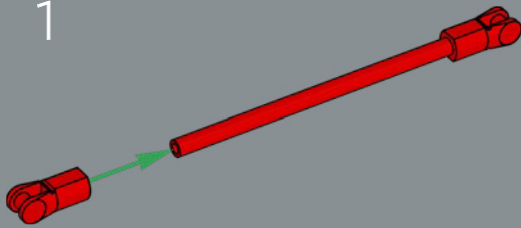

2

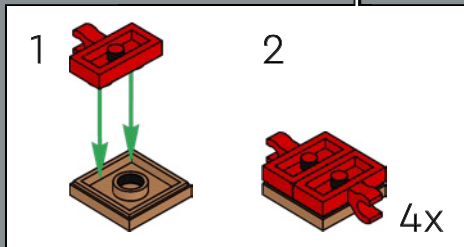
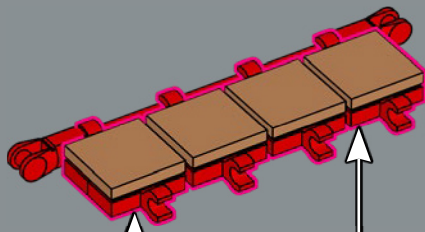

3

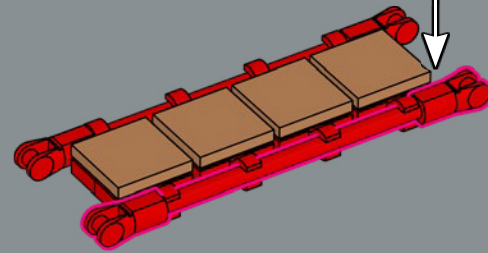

4

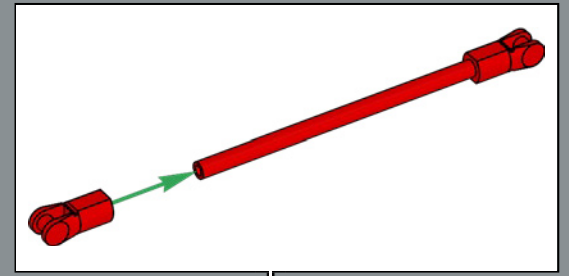
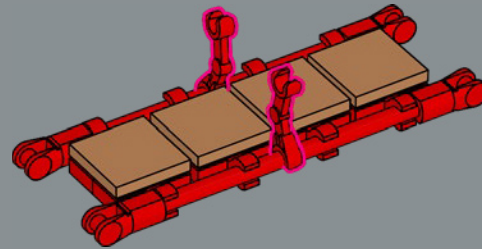

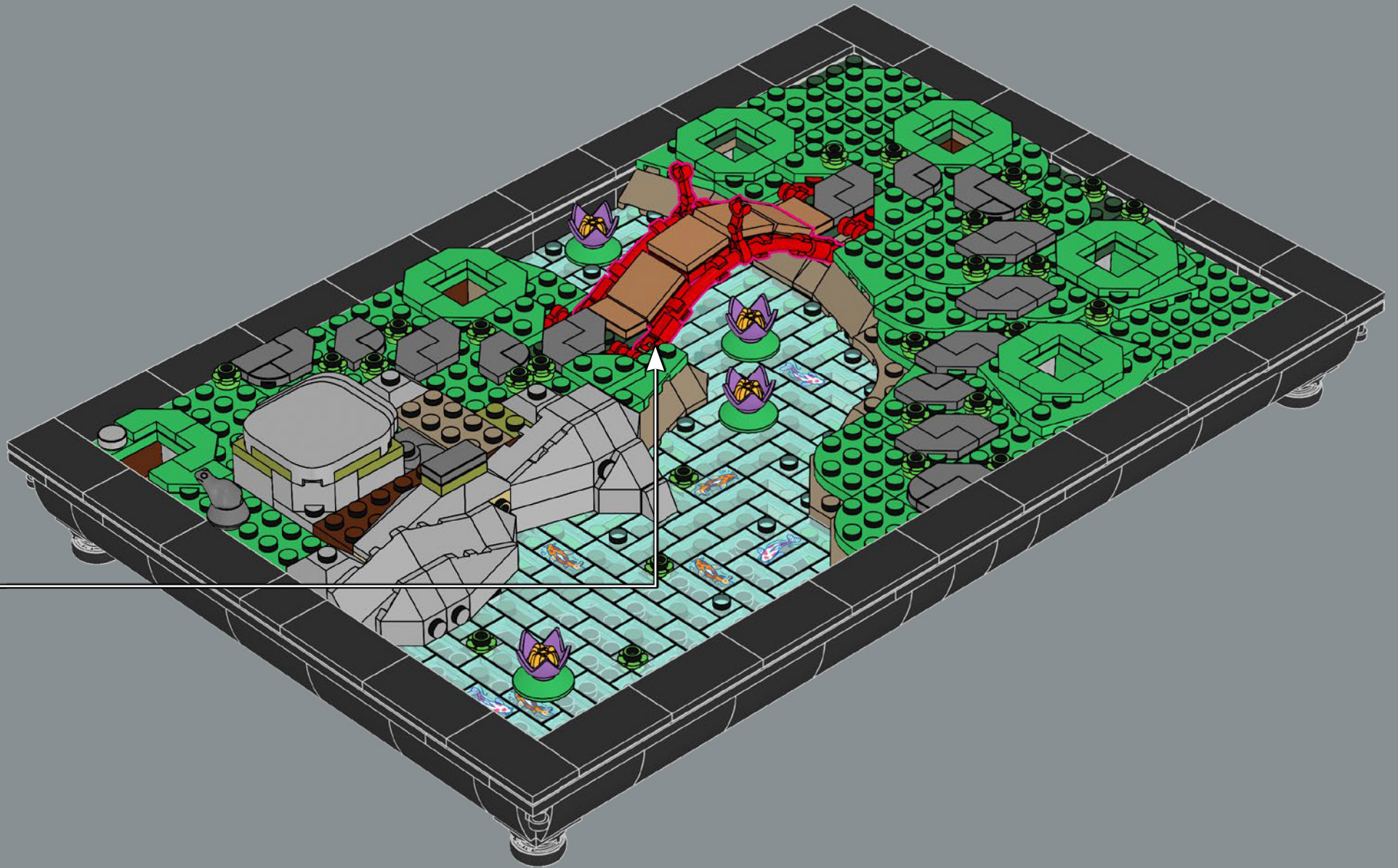

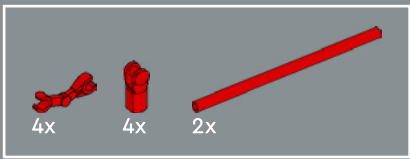

117

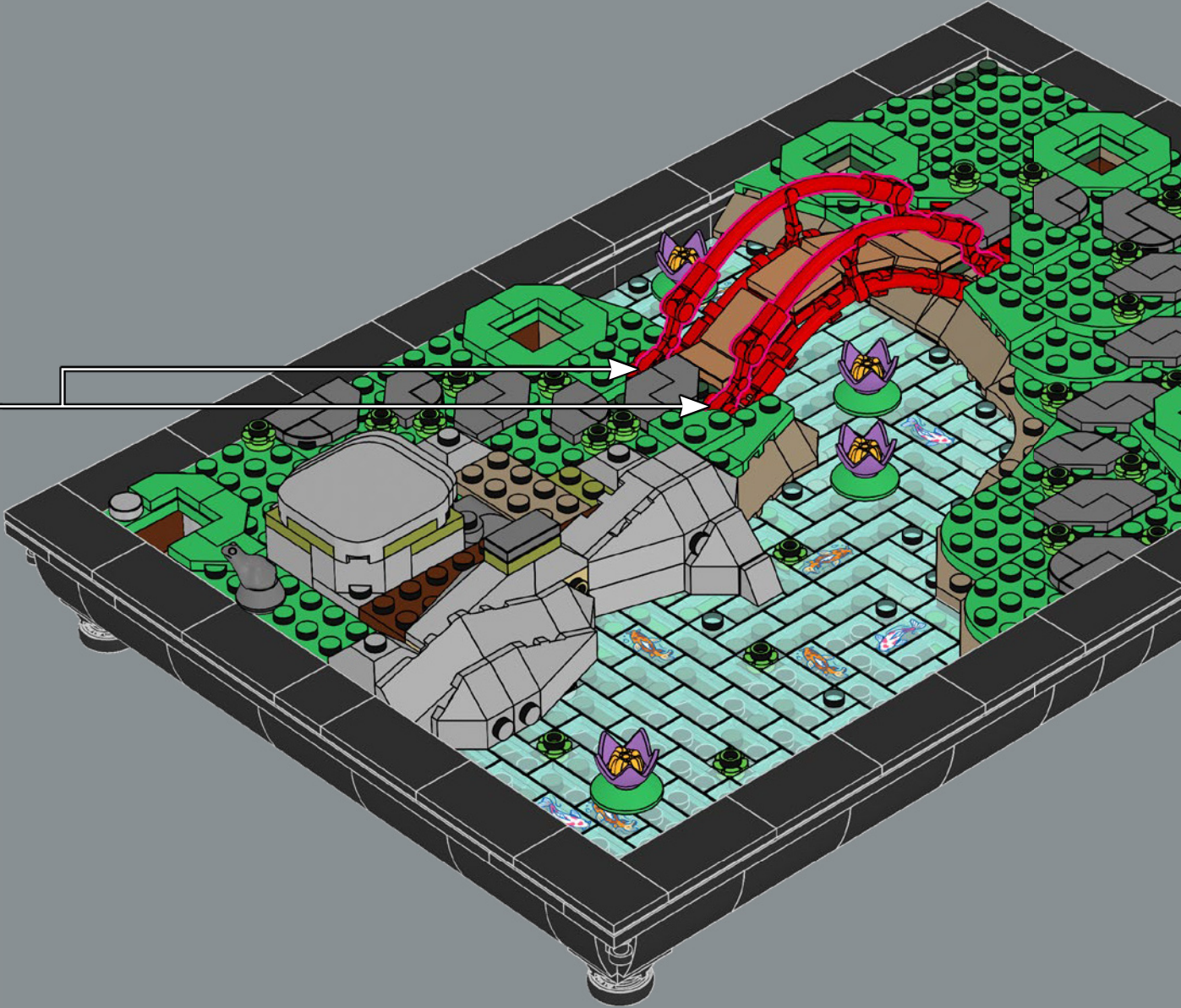
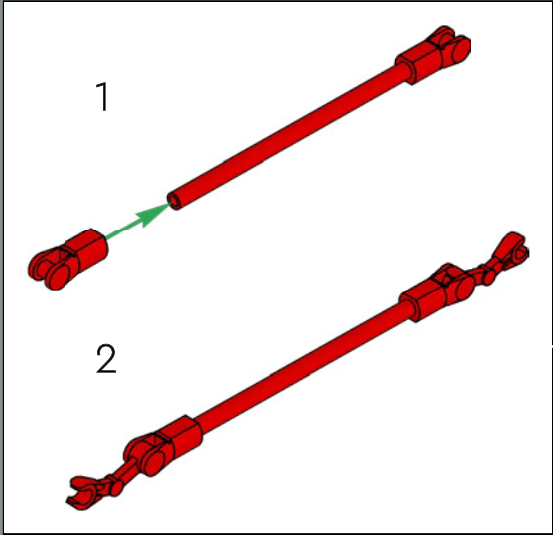



118

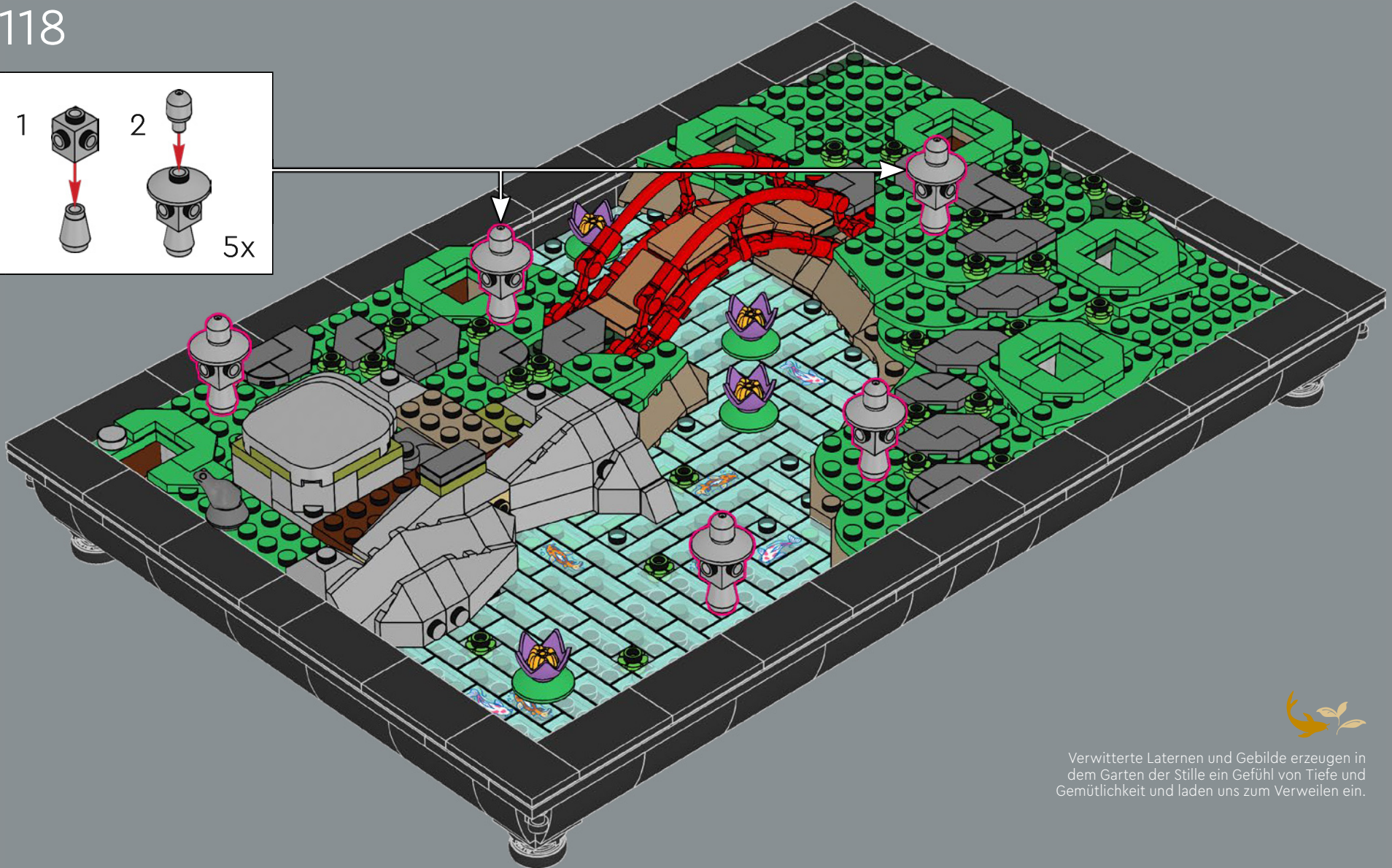
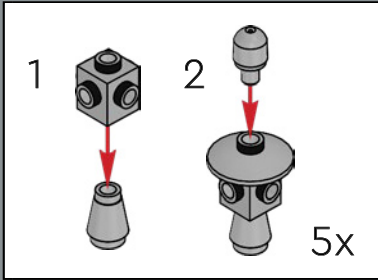

Verwitterte Laternen und Gebilde erzeugen in dem Garten der Stille ein Gefühl von Tiefe und Gemütlichkeit und laden uns zum Verweilen ein.

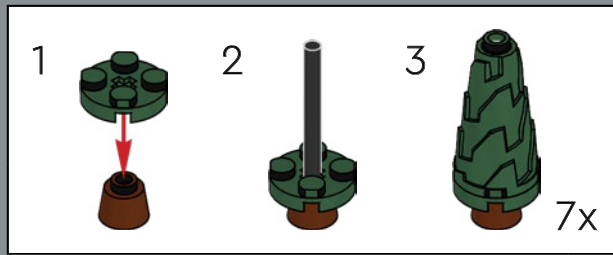
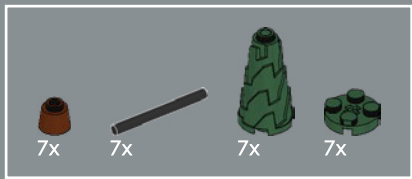

119



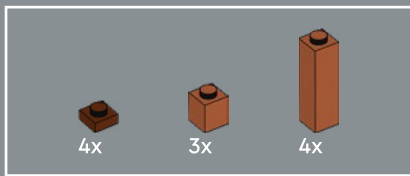

120

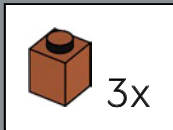

121



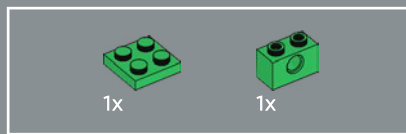
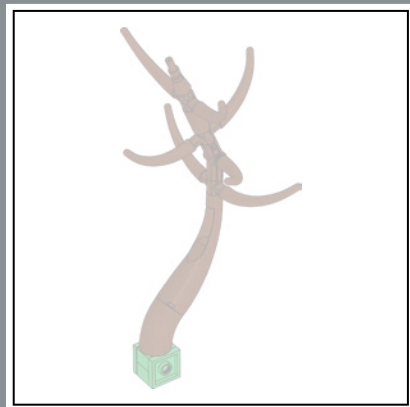

122

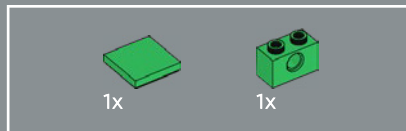
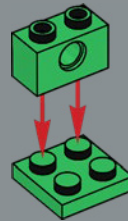

123

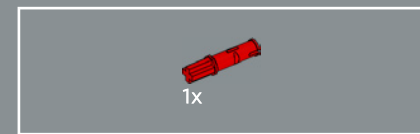
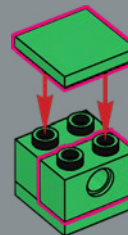

124

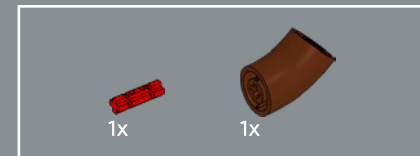
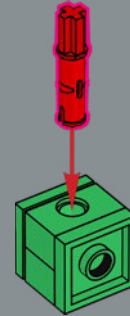

125

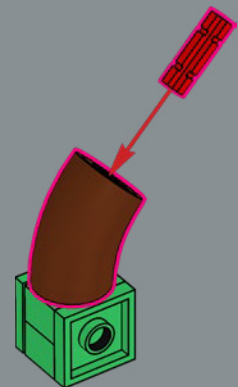

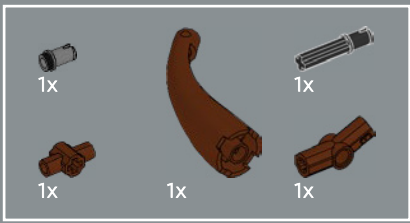

126

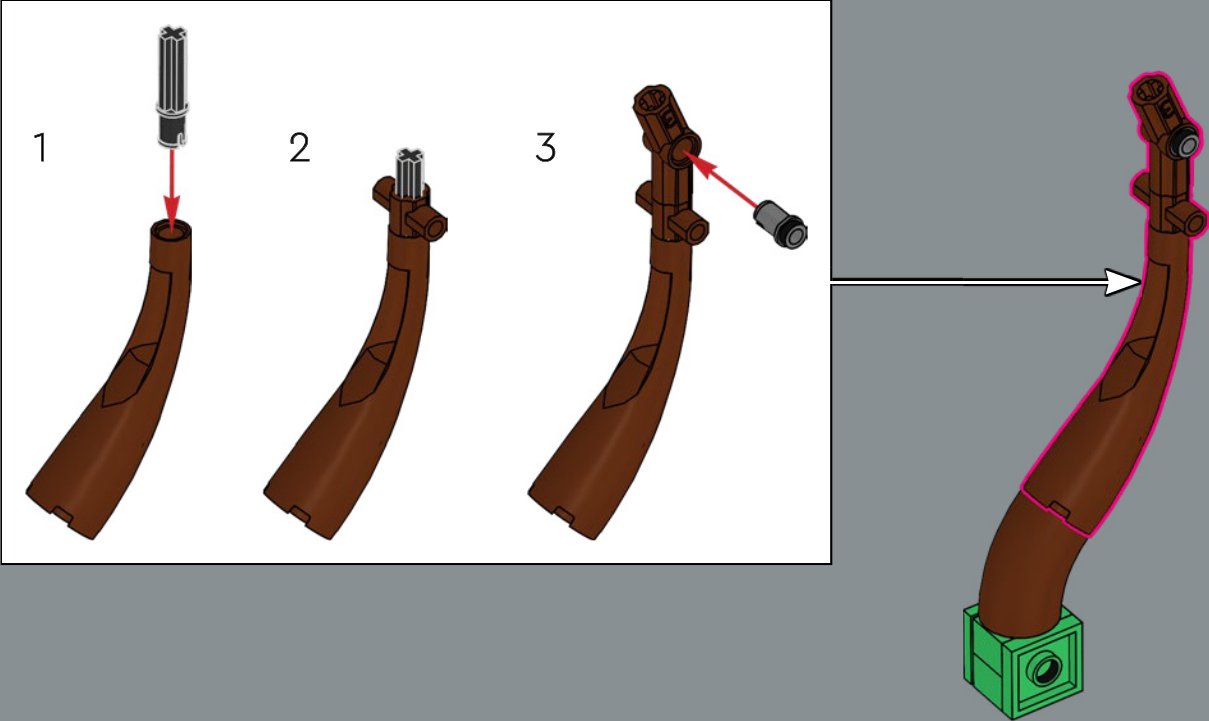

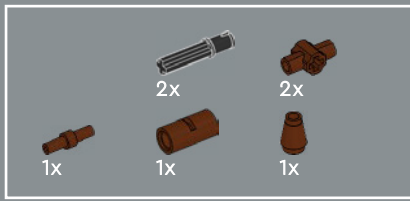

127

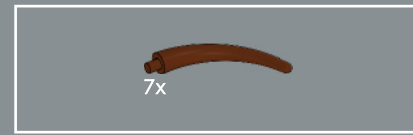
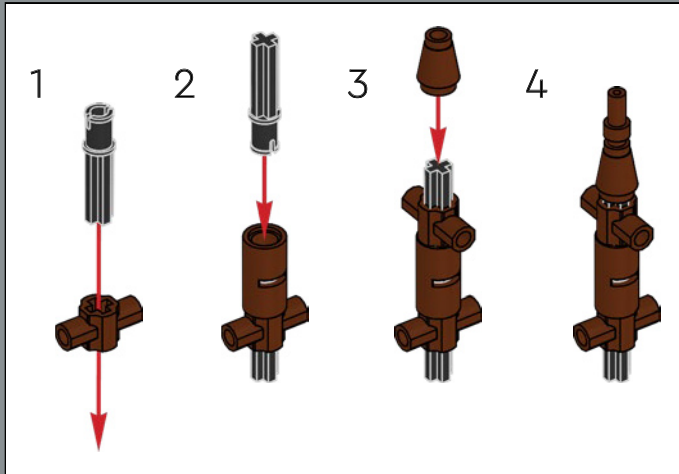

128





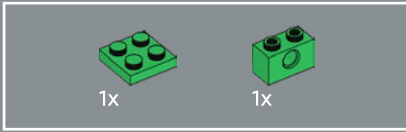
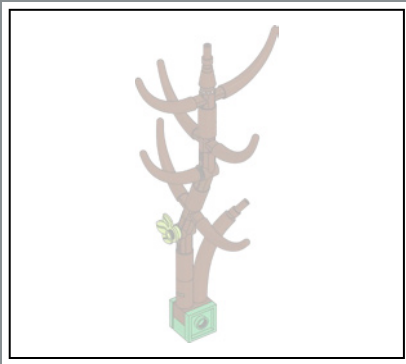

130

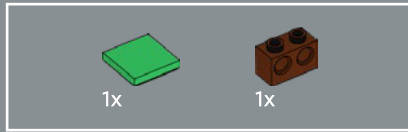
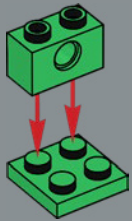

131

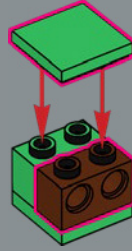

132

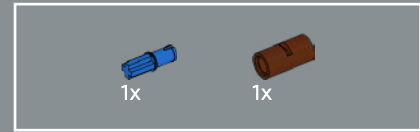

133

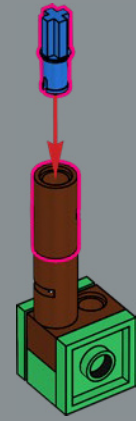

134

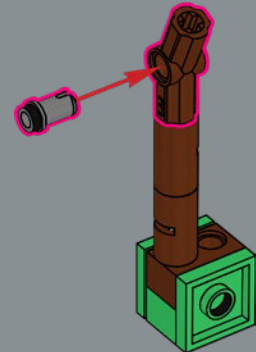

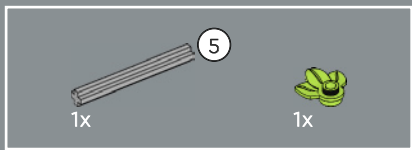

135

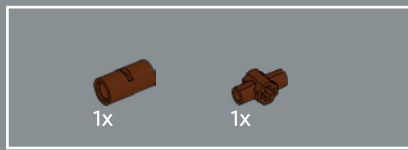
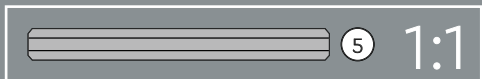

136

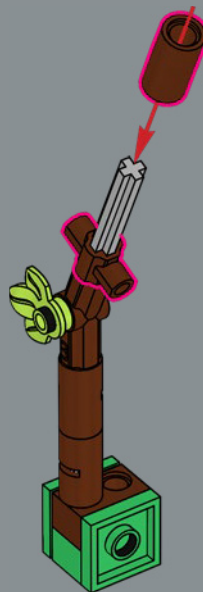

137



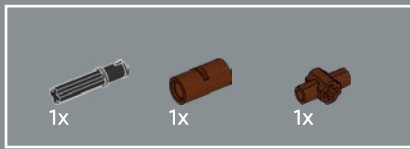

138

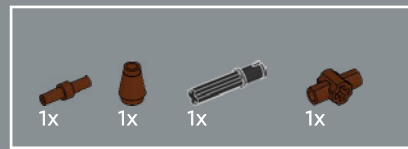
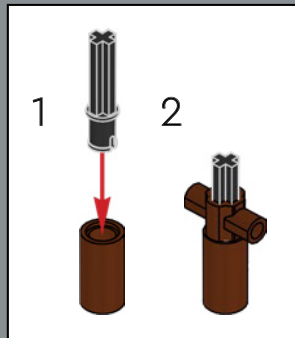

139

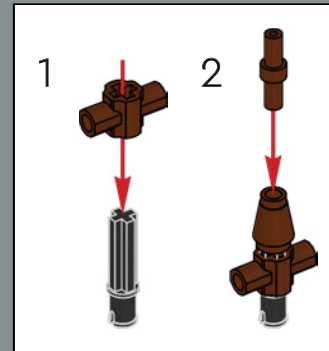

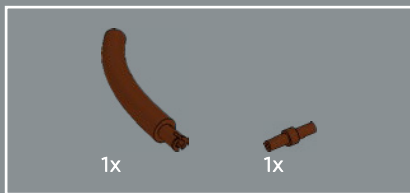

140

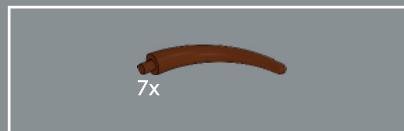
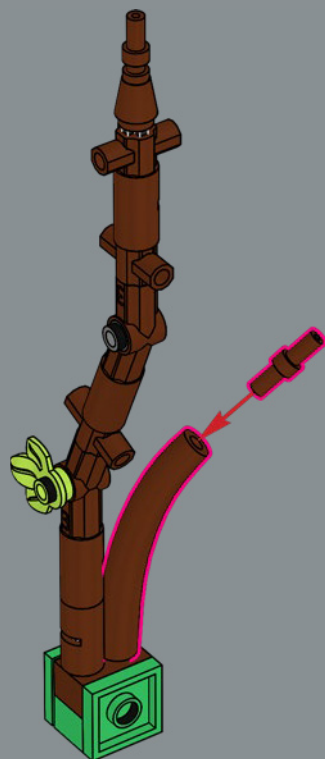

141

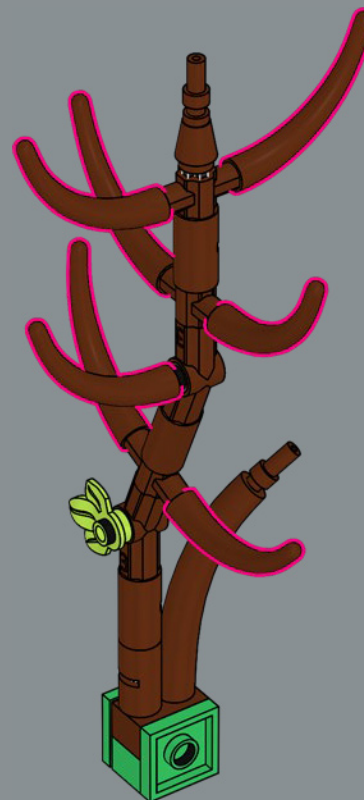

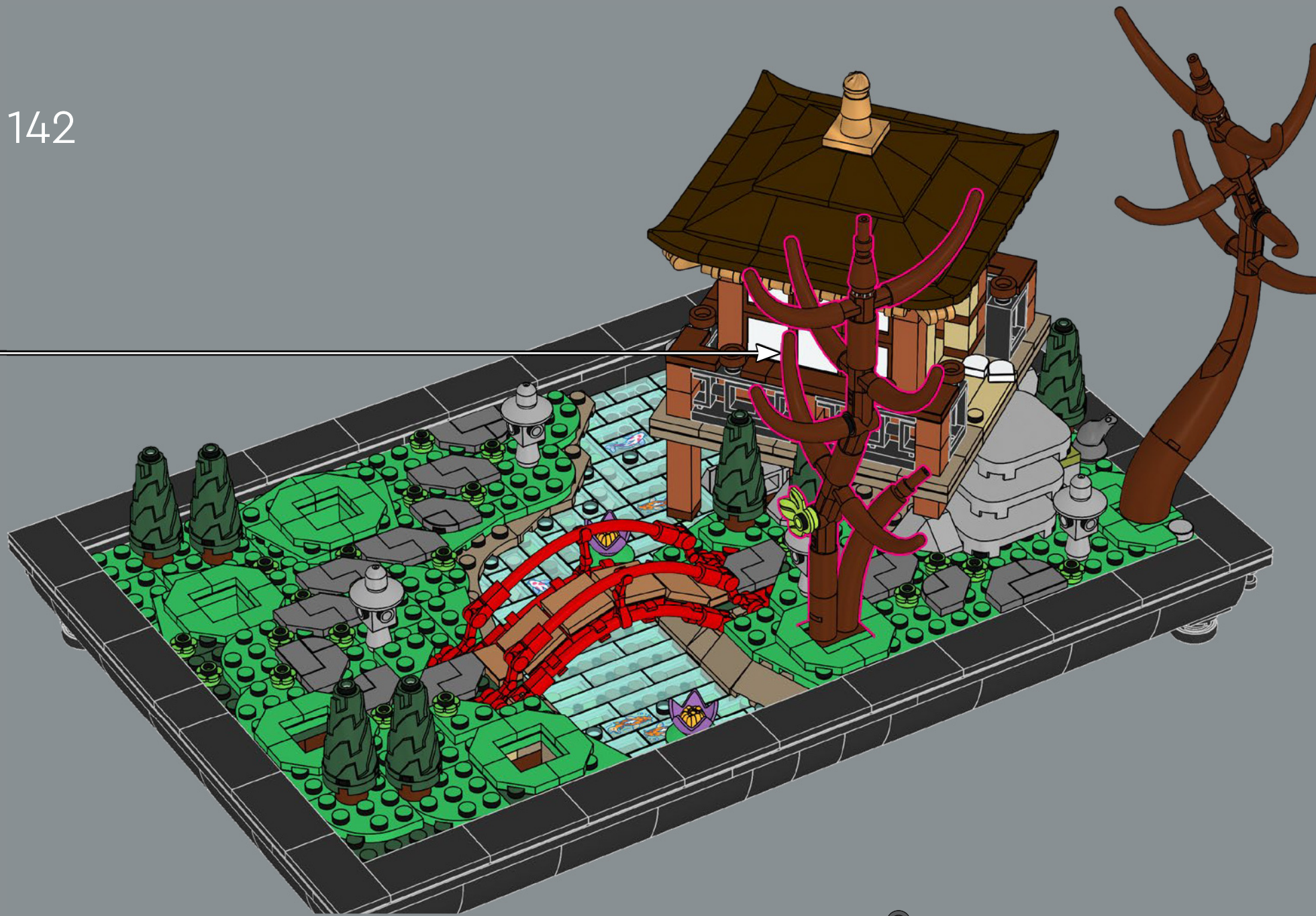

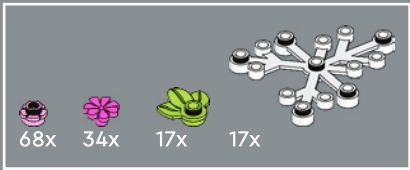

143

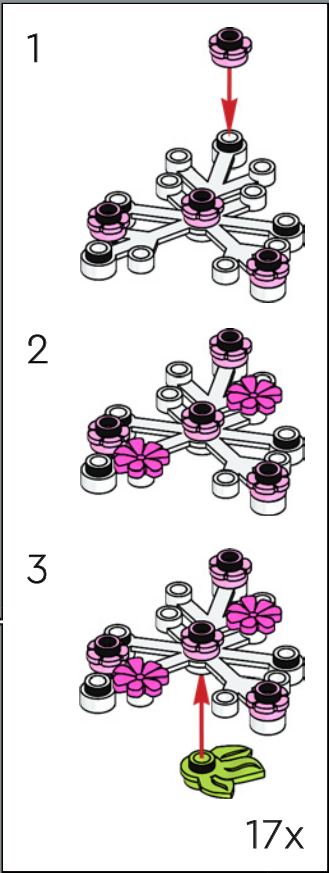

Das richtige Verhältnis von Wasser, sorgfältig ausgewählten Pflanzen und unterschiedlich genutzten Felsen verwandelt deinen Garten in eine Ruheoase.

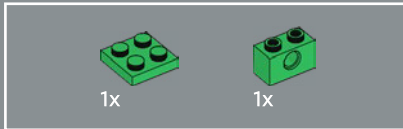
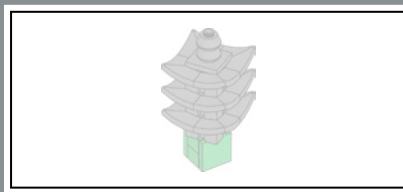

144

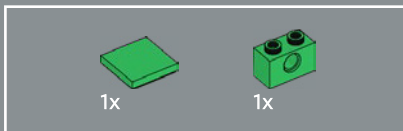
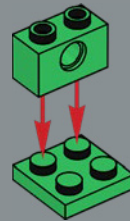

145

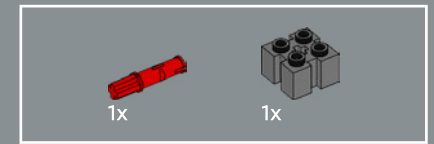
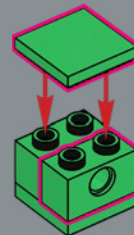

146

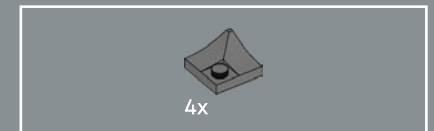
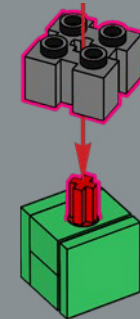

147

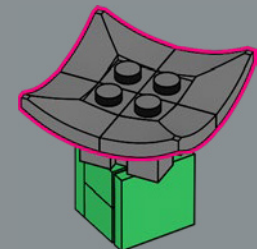

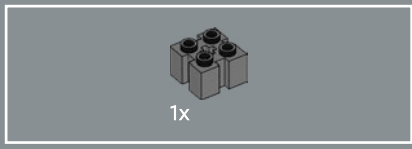

148

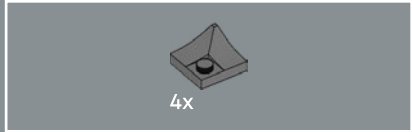
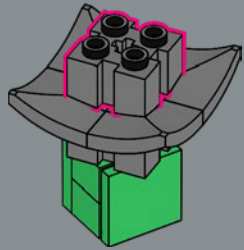

149

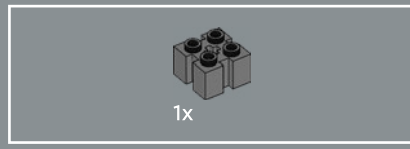
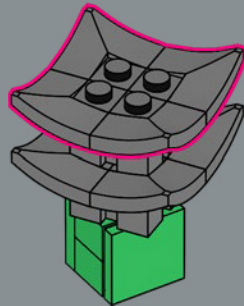

150

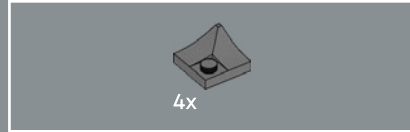
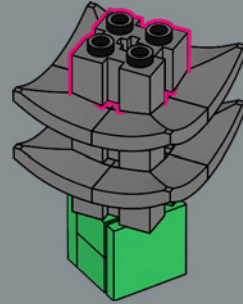

151

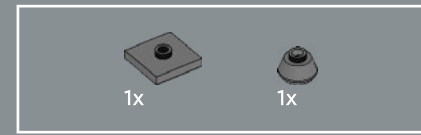
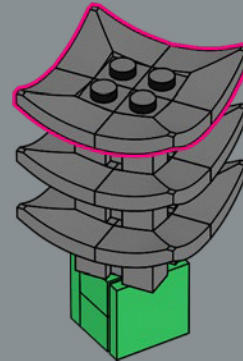

152

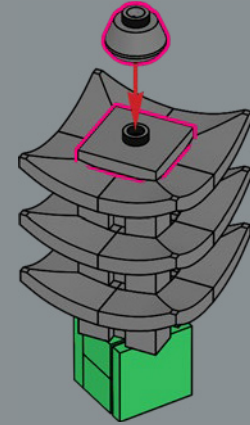

153

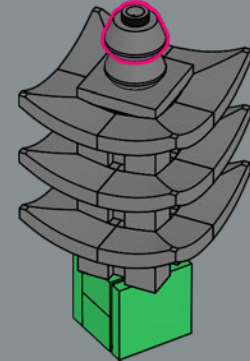

154

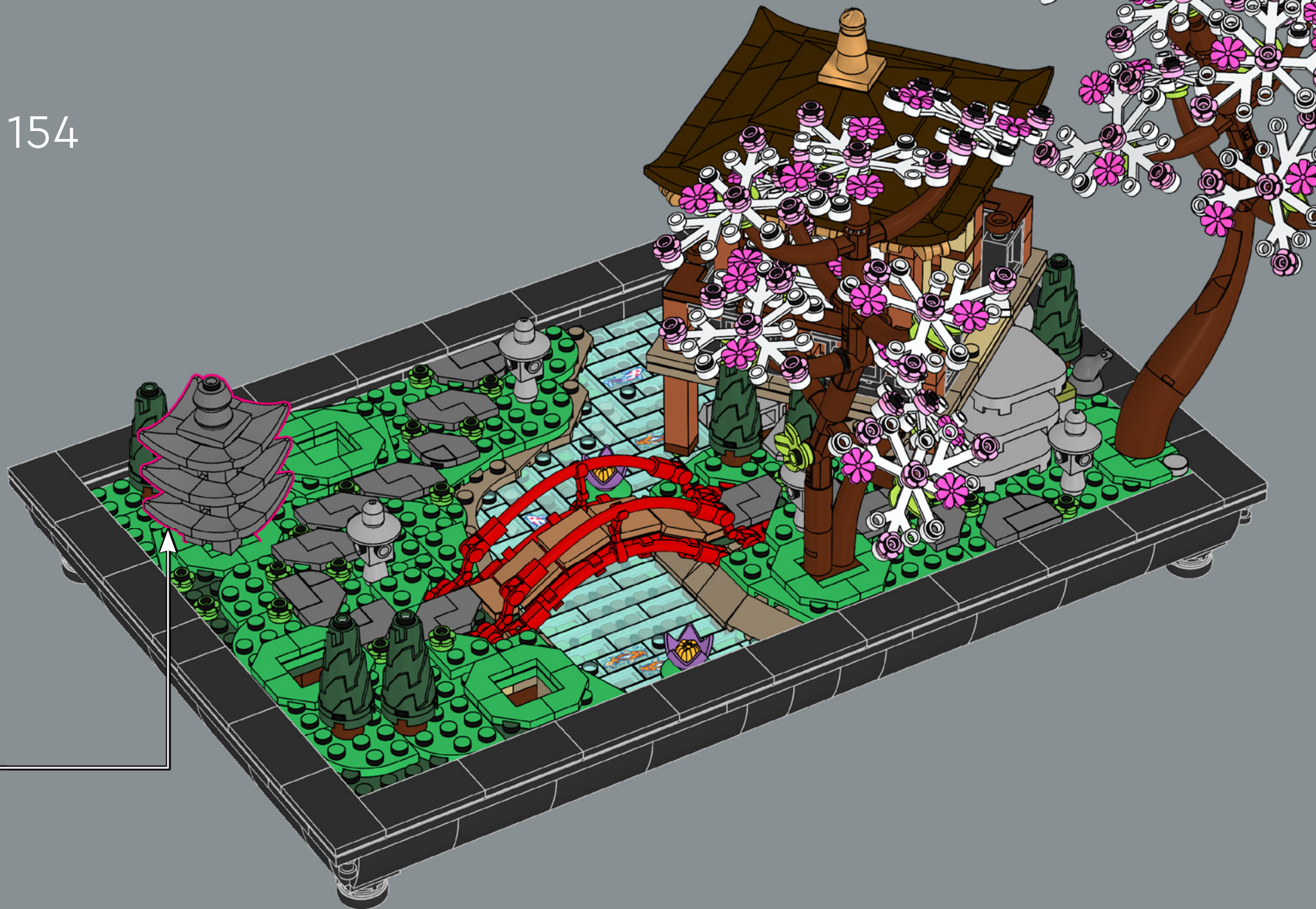

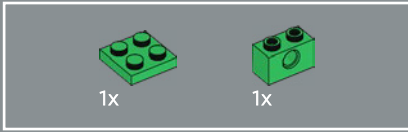
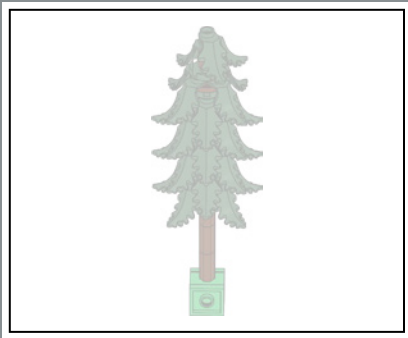

155

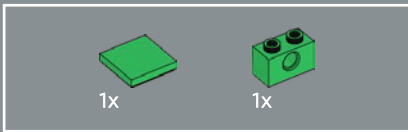
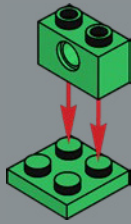

156

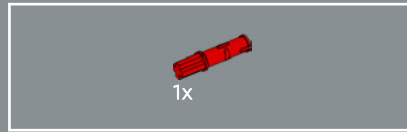
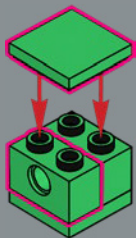

157

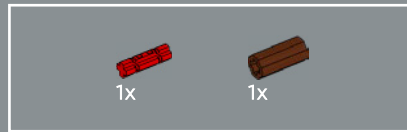
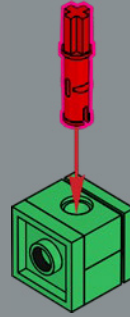

158

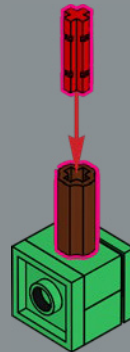

159

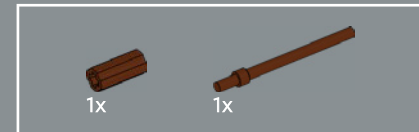
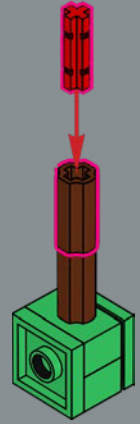

160

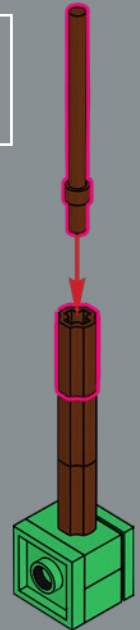



161

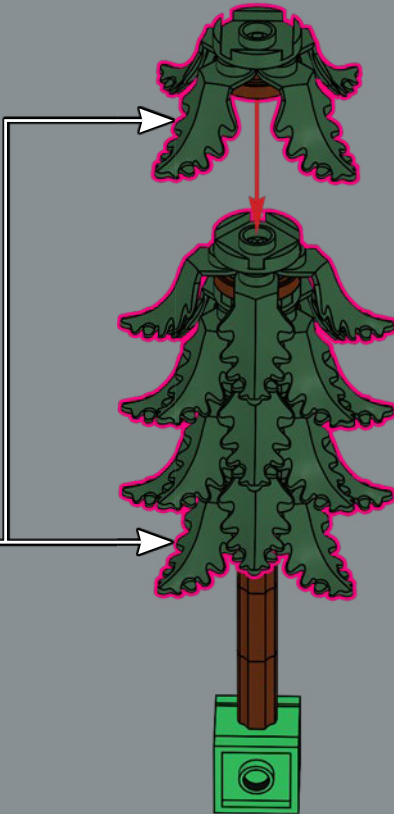

162

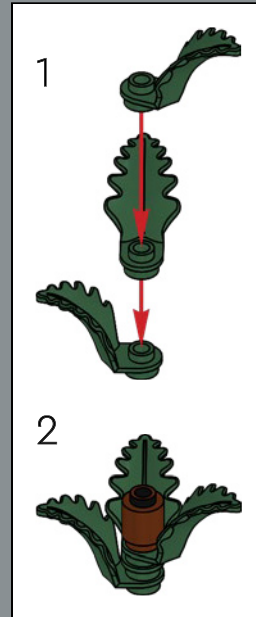



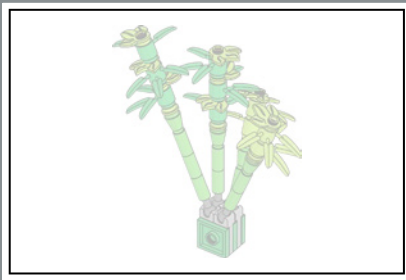

164

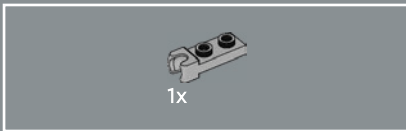
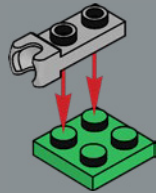

165

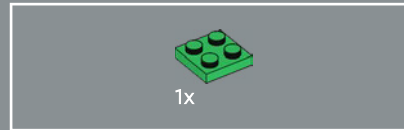
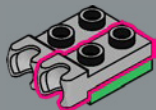

166

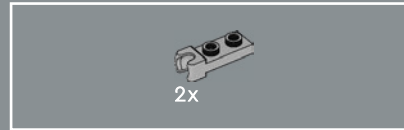
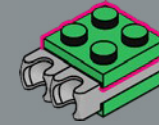

167

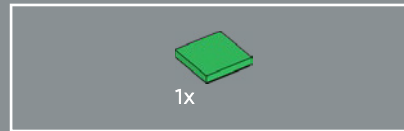
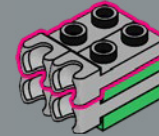

168

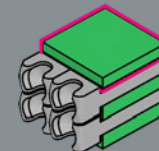



169

1



2

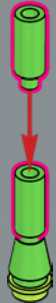

3



4



5

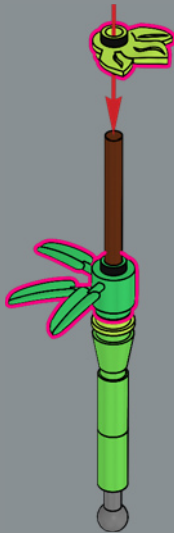

6

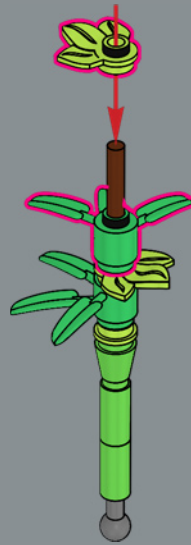

7

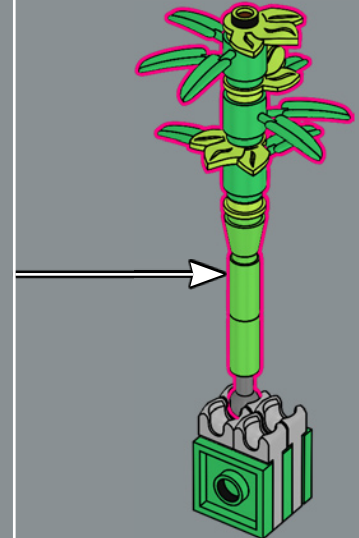
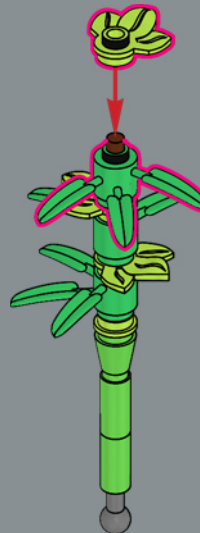



170 1

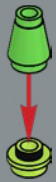

2

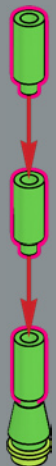

3



4



5

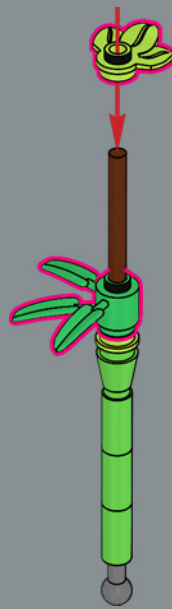

6

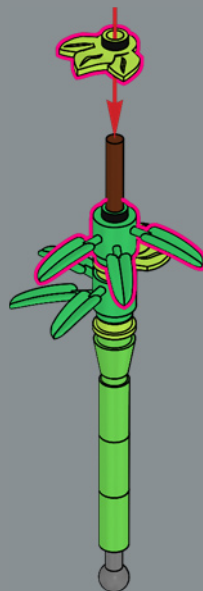

7

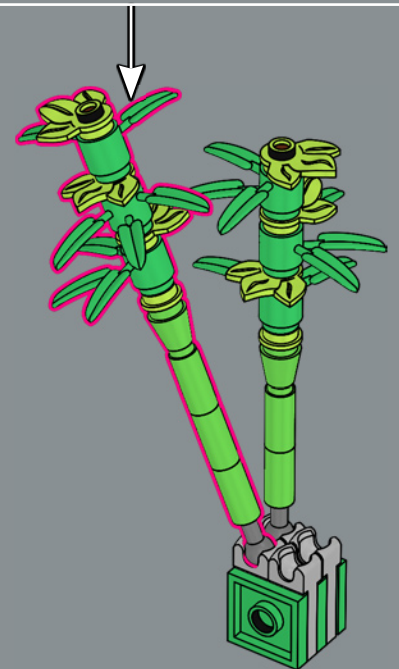

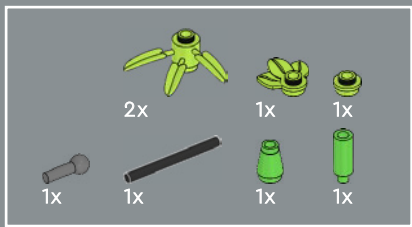

171

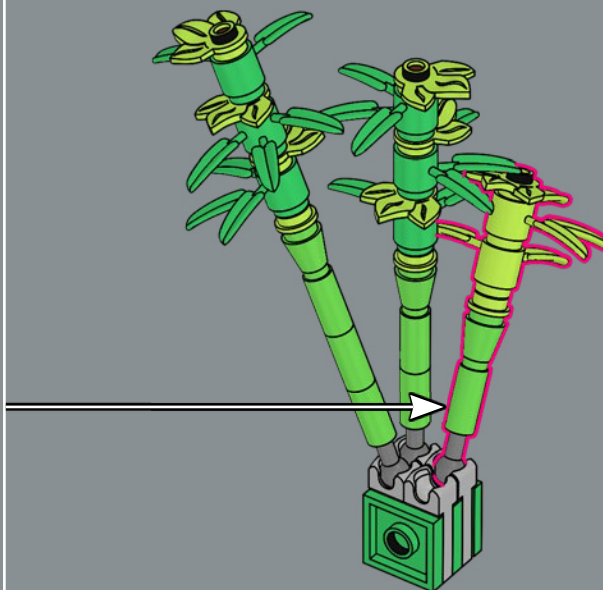
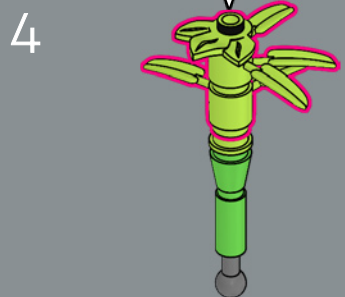
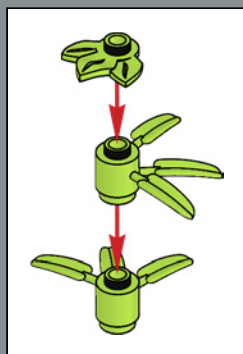
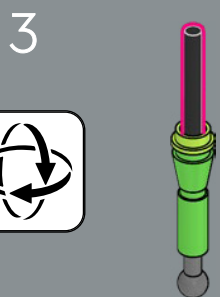
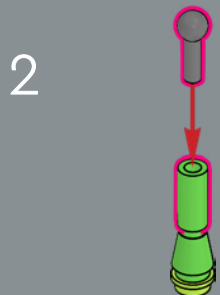
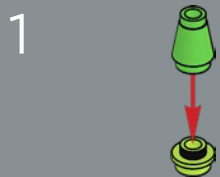

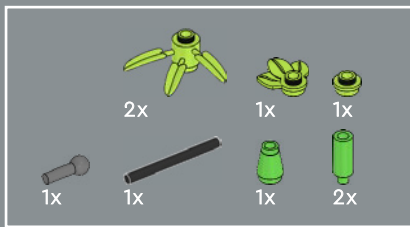

172

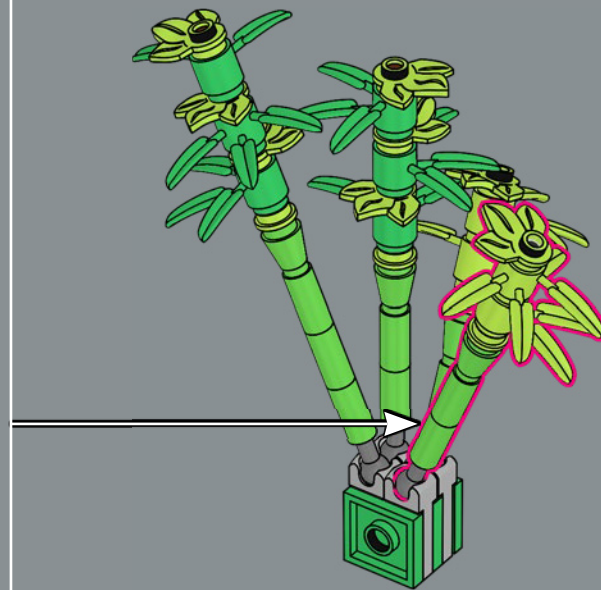
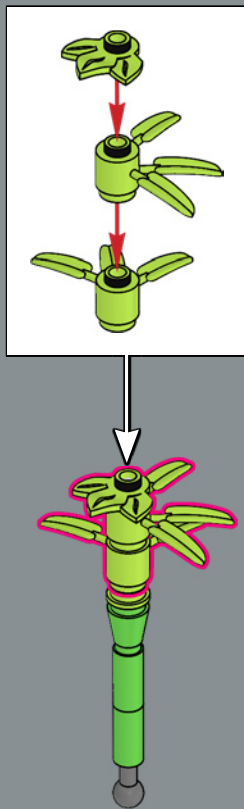
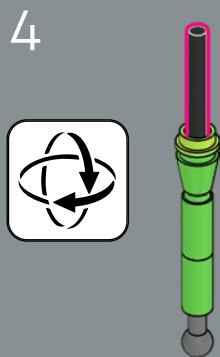
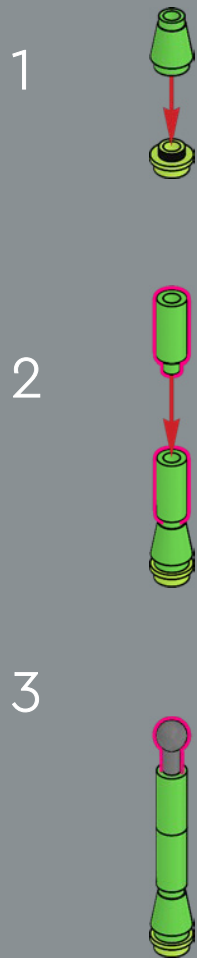



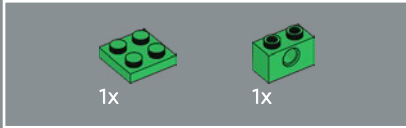

174

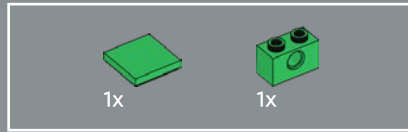
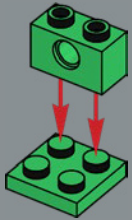

175

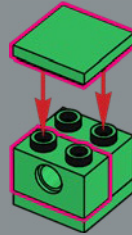

176

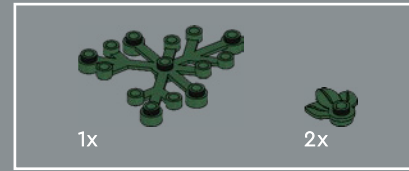
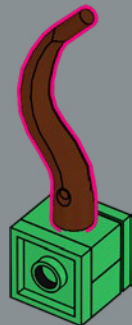

177

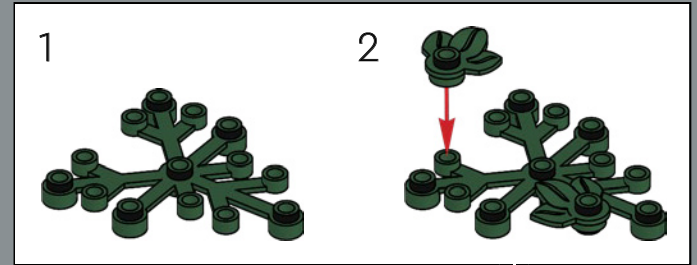

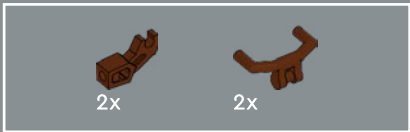

178

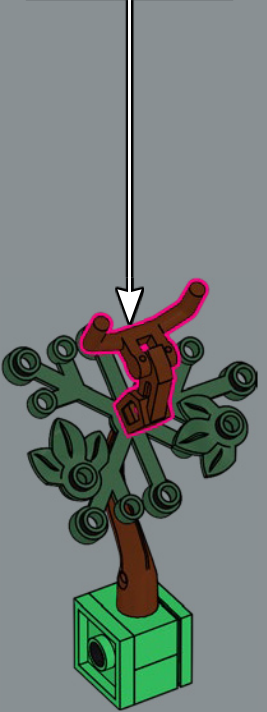
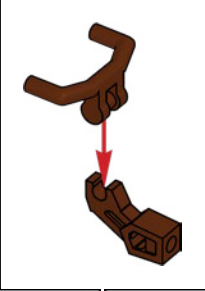

179

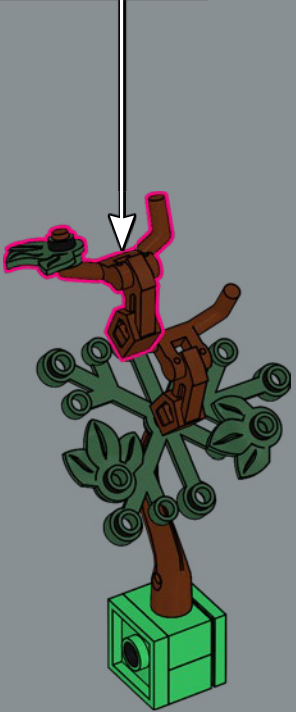
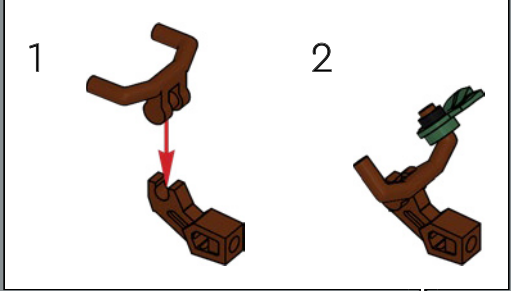

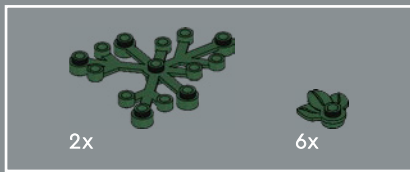

180

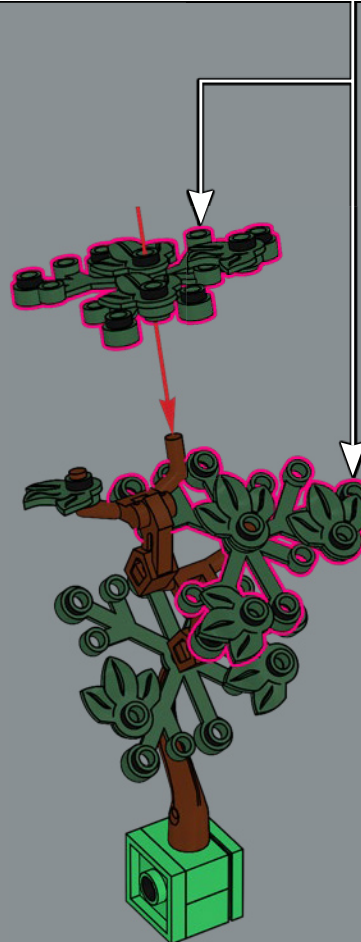
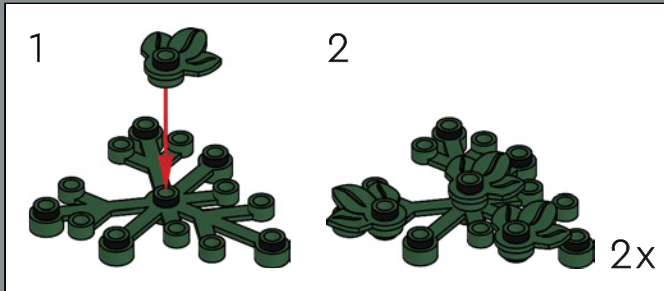



Du möchtest deinem Modell deine ganz persönliche Note verleihen?
Dann lass dich von den fünf Prinzipien für Gärten der Stille leiten: Umzäunung,
Balance, entlehntes Landschaftsbild, Symbolismus und Asymmetrie.

1x 4206482	8x 6456644	1x 6284070	2x 6250591	13x 4621947	25x 6252043	4x 6040126	2x 6284583	14x 6035029
1x 6456641	8x 6313120	2x 6279875	2x 6198979	10x 4621946	3x 6435012	7x 4528604	4x 6190251	1x 6328333
1x 6286492	4x 4515365	4x 4515368	18x 6256077	4x 4567908	6x 6459216	6x 6092591	26x 6286831	1x 6328333
2x 6055783	6x 6370686	4x 4180536	17x 6266969	4x 6311453	102x 6251295	15x 6126075	4x 6175572	31x 6447541
4x 4113915	3x 4142865	2x 6382697	8x 6328327	10x 6062166	5x 6252049	1x 6331865	9x 6400754	7x 6167130
4x 4113915	3x 6209519	3x 302326	1x 302428	6x 6270003	5x 302124	1x 6388214	7x 6167129	7x 6461425
2x 6057517	3x 300121	6x 302226	17x 302328	4x 6331100	5x 6253273	4x 6184880	3x 6331861	16x 6013975
3x 6214334	4x 6456646	2x 306826	23x 6385275	29x 6206150	1x 6253273	3x 6331861	2x 6390053	2x 6240030
4x 6257600	30x 4162443	4x 302126	7x 302228	8x 302128	8x 6397875	1x 6331863	7x 4650244	1x 6411592
4x 6294227	10x 6053077	8x 302026	6x 4107762	2x 379528	2x 6092602	1x 4247145	2x 4586057	3x 6416003
1x 6294227	10x 4516843	30x 4560182	9x 6230235	1x 303428	2x 6288614	2x 6038637	3x 6266967	4x 6456642
4x 4112982	5x 6089119	26x 4587844	1x 4109674	3x 383228	1x 6426644	2x 4267874	3x 6266967	4x 6456642
7x 4544139	10x 6252373	2x 303426	7x 4181135	3x 383228	2x 6288614	1x 6328338	4x 4245566	1x 6240515
9x 4113988	6x 6195092	11x 428226	3x 4143953	3x 6398657	1x 6426644	3x 6114515	2x 6302995	1x 6240515
1x 4125217	9x 6116604							

- 1x 4211183
- 3x 4211288
- 4x 4221744
- 1x 6151461
- 14x 4211190
- 5x 4216945
- 1x 4211214
- 2x 4225715
- 3x 6258989

- 1x 6348057
- 2x 4529242
- 7x 6173143
- 7x 6102360
- 3x 6451002
- 3x 4531751
- 2x 6276868
- 18x 6382102
- 1x 6326087
- 1x 6383996
- 1x 6327811

- 9x 6186673
- 12x 4211257
- 4x 6221608
- 2x 6327818
- 5x 6173132
- 3x 6261388
- 5x 4211200
- 3x 4211194
- 6x 6459423
- 3x 6170468
- 1x 6292952
- 14x 6372430
- 1x 6070442
- 8x 4211247

- 8x 4550325
- 5x 4211387
- 5x 4211511
- 3x 4651063
- 1x 4526932
- 1x 4521921
- 1x 4515374
- 8x 6034676
- 1x 6013497
- 1x 6315580
- 2x 4180418
- 1x 6315579

- 1x 4180408
- 1x 6401023
- 1x 4211397
- 1x 4211549
- 1x 4211639
- 5x 4211512
- 2x 4211400
- 2x 4598522
- 2x 4620130

5

- 5x 6284071
- 5x 6212288
- 5x 4529241
- 4x 4211353
- 4x 6043639
- 3x 6354325

- 3x 6395635
- 4x 6364352
- 7x 6199549
- 3x 6340333
- 1x 6171103
- 1x 4218696
- 1x 6126083
- 4x 4211052
- 21x 6177079
- 3x 6236949
- 12x 6447212
- 1x 4211100
- 1x 6106191
- 2x 4210678
- 1x 4211137

- 8x 6016483
- 34x 6206151
- 68x 6212501
- 1x 6186383
- 4x 6212377
- 16x 6279731
- 1x 6190252
- 2x 6173139
- 1x 6050916

- 8x 6456639
- 4x 6456643
- 4x 6456663
- 16x 6347604
- 2x 6021997
- 10x 6102990
- 4x 6347304
- 1x 6363146
- 4x 6456640



LEGO.com/service



YOU COULD WIN



YOU COULD WIN

Your feedback will help shape the future development of this product series.

Visit:

DU KÖNNTEST GEWINNEN

Dein Feedback trägt zur Weiterentwicklung dieser Produktreihe bei.

Geh auf:

VOUS POURRIEZ GAGNER

Vos commentaires nous aideront à concevoir les futurs produits de cette gamme.

Visitez :

POTRESTI VINCERE TU

La tua opinione ci aiuterà a migliorare la creazione futura di questa linea di prodotti.

Visita:

PUEDES GANAR

Tu opinión contribuirá al futuro de esta serie de productos.

Visita:

轻松获奖

您的反馈将有助于我们在今后改进本产品系列。

请访问:

LEGO.com/productfeedback

You also have the chance to win a LEGO® set.

Terms and conditions apply.*

Außerdem hast du die Chance, ein LEGO® Set zu gewinnen.

Es gelten die Teilnahmebedingungen.*

Vous pourriez également gagner un ensemble LEGO®.

Des conditions s'appliquent.*

Hai anche la possibilità di vincere un set LEGO®.

Termini e condizioni sono applicabili.*

También tienes la oportunidad de ganar un set LEGO®.

Aplican términos y condiciones.*

您还有机会赢取乐高®套装。

条款和条件适用。*

*LEGO.com/productfeedback-terms



LEGO and the LEGO logo are trademarks of the LEGO Group.
©2023 The LEGO Group.