



BOEING 787™



Produced under license from Boeing Management Company. 767, 787, Dreamliner, and Boeing are among the trademarks owned by Boeing.



WARNING: CHOKING HAZARD-
Toy contains small parts.
Not for children under 3 years.





1



2

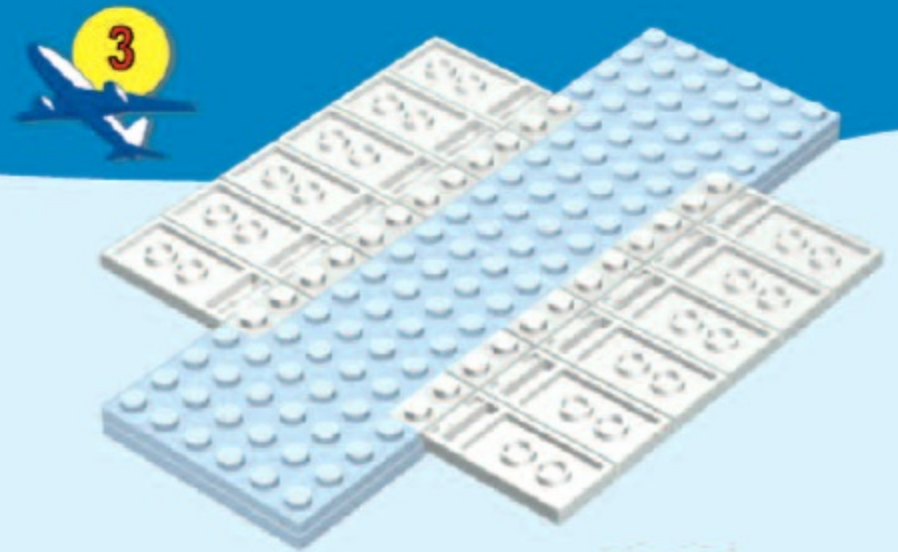

3



X10



X2

X2

X2

X2



X12

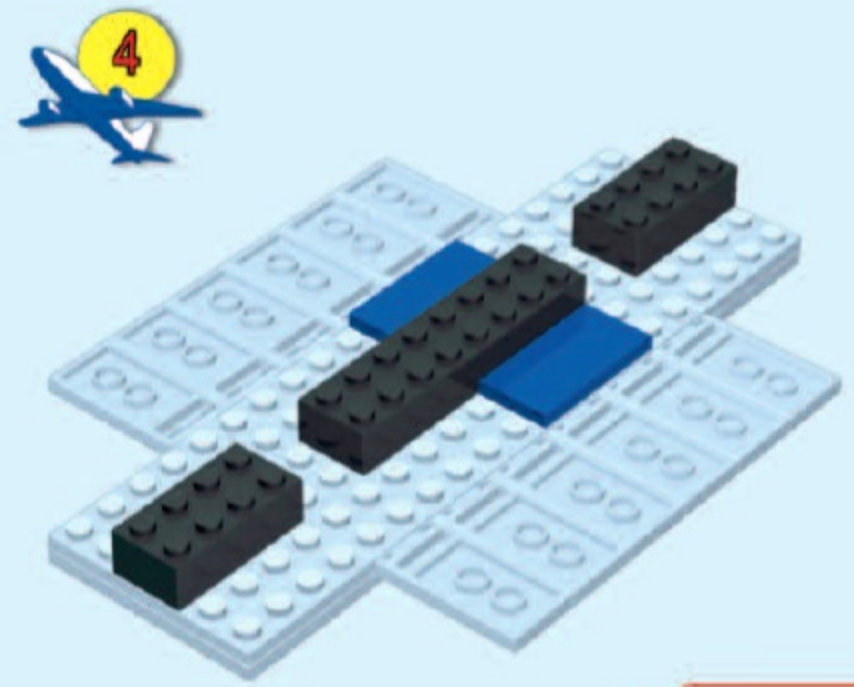

4

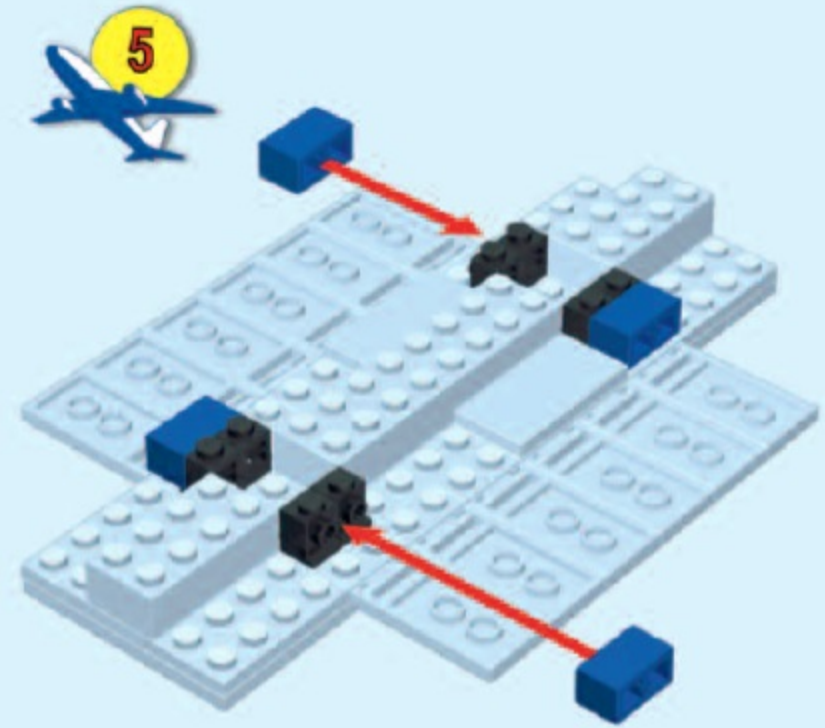

5



6



X2

X2

X1



X8

X4



X12

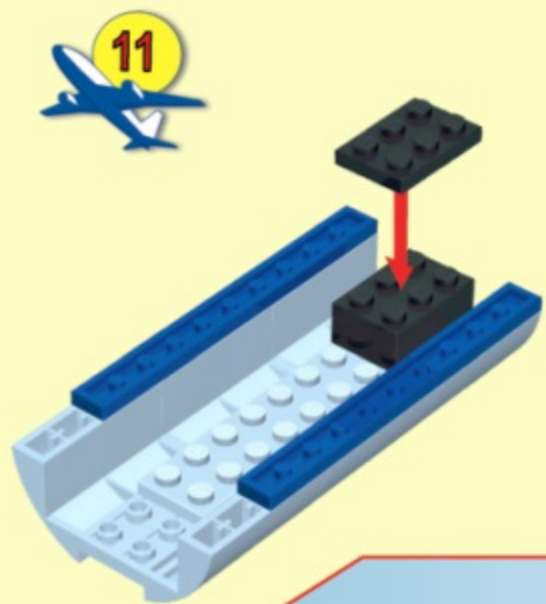
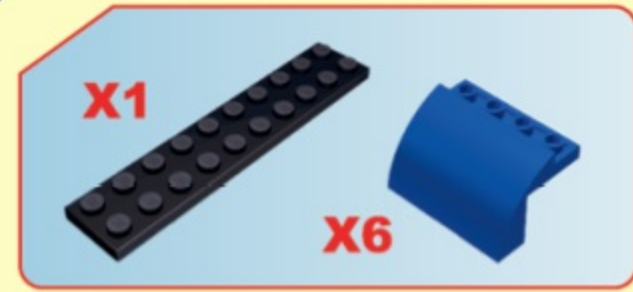
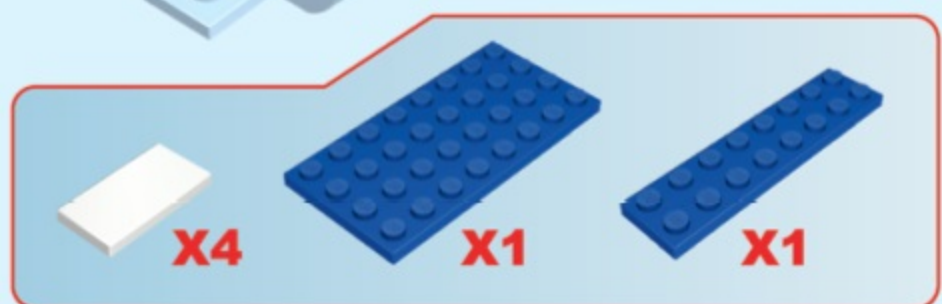
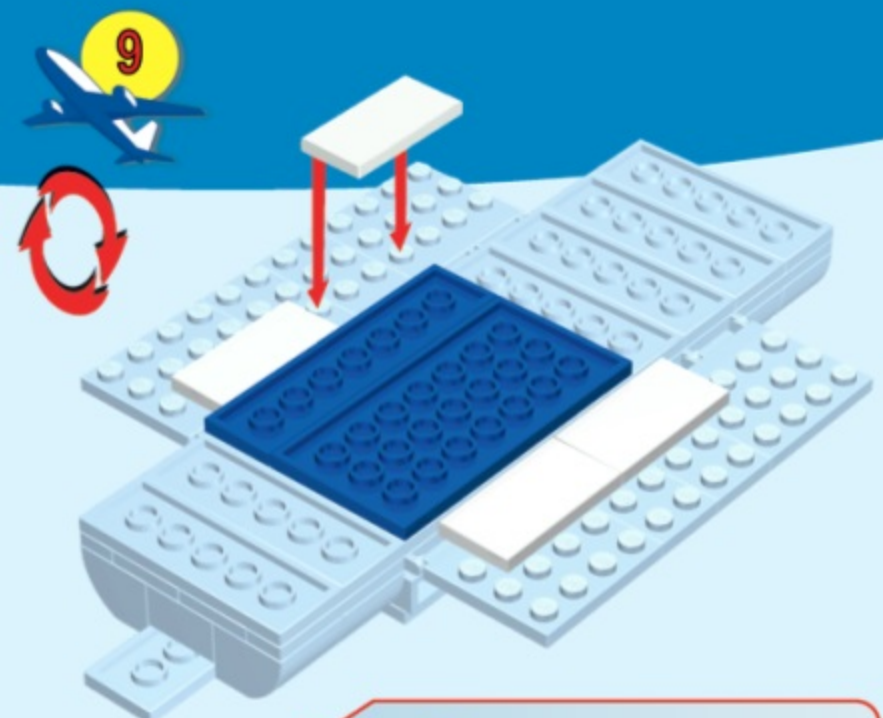
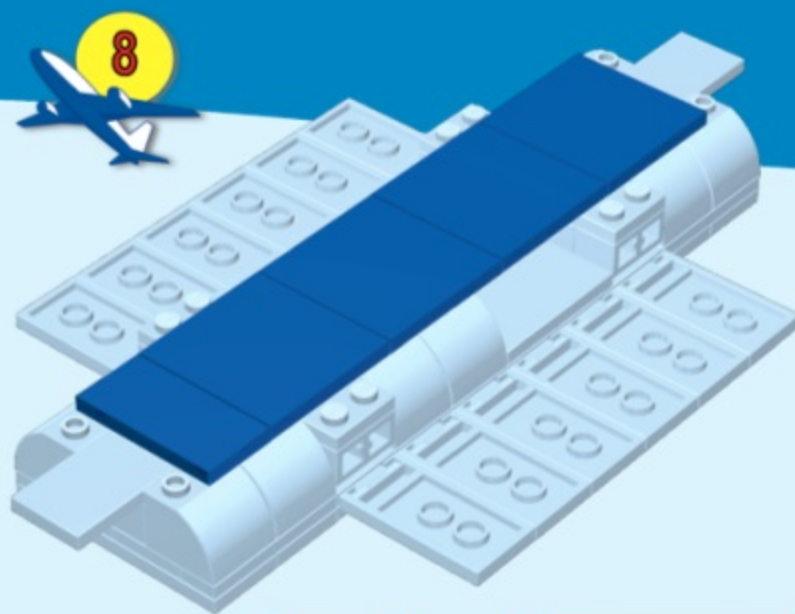
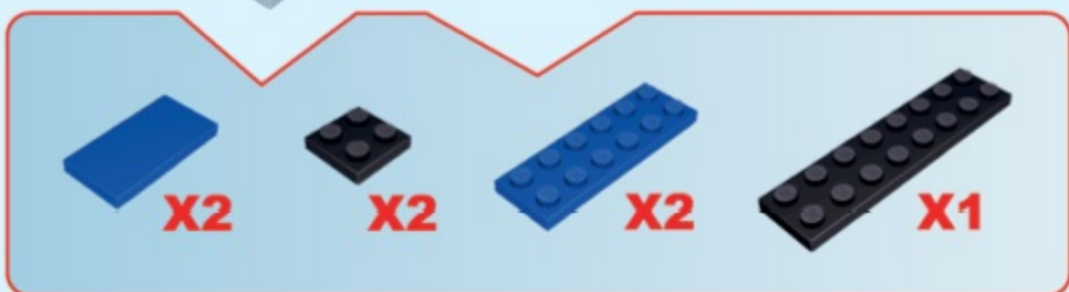
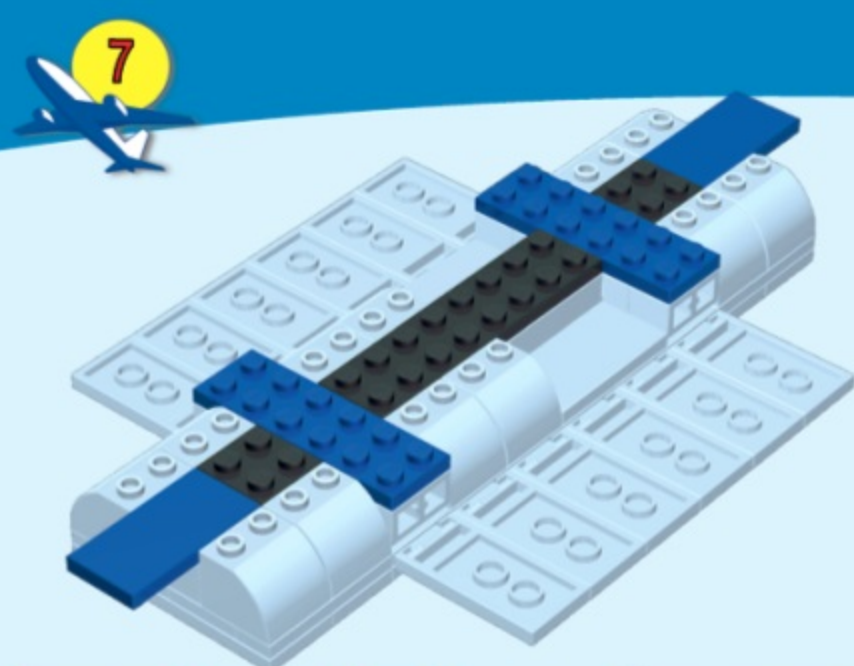

13

(A) + (B)

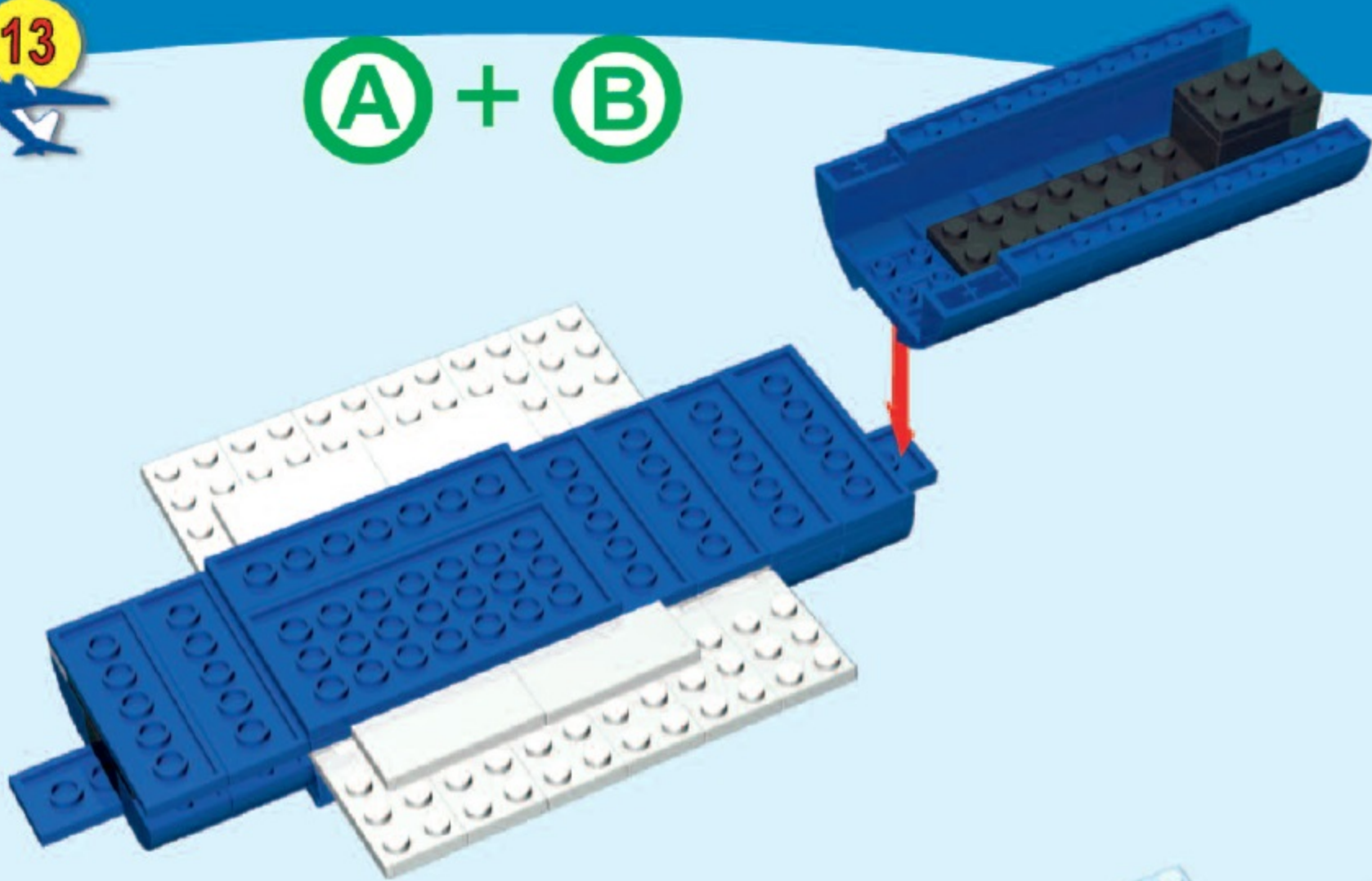

14

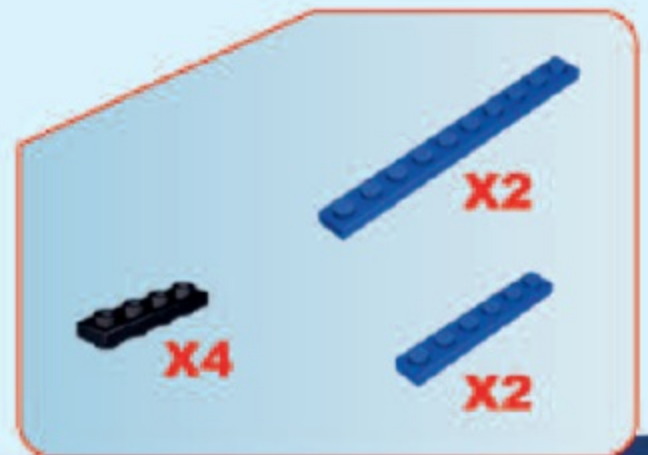
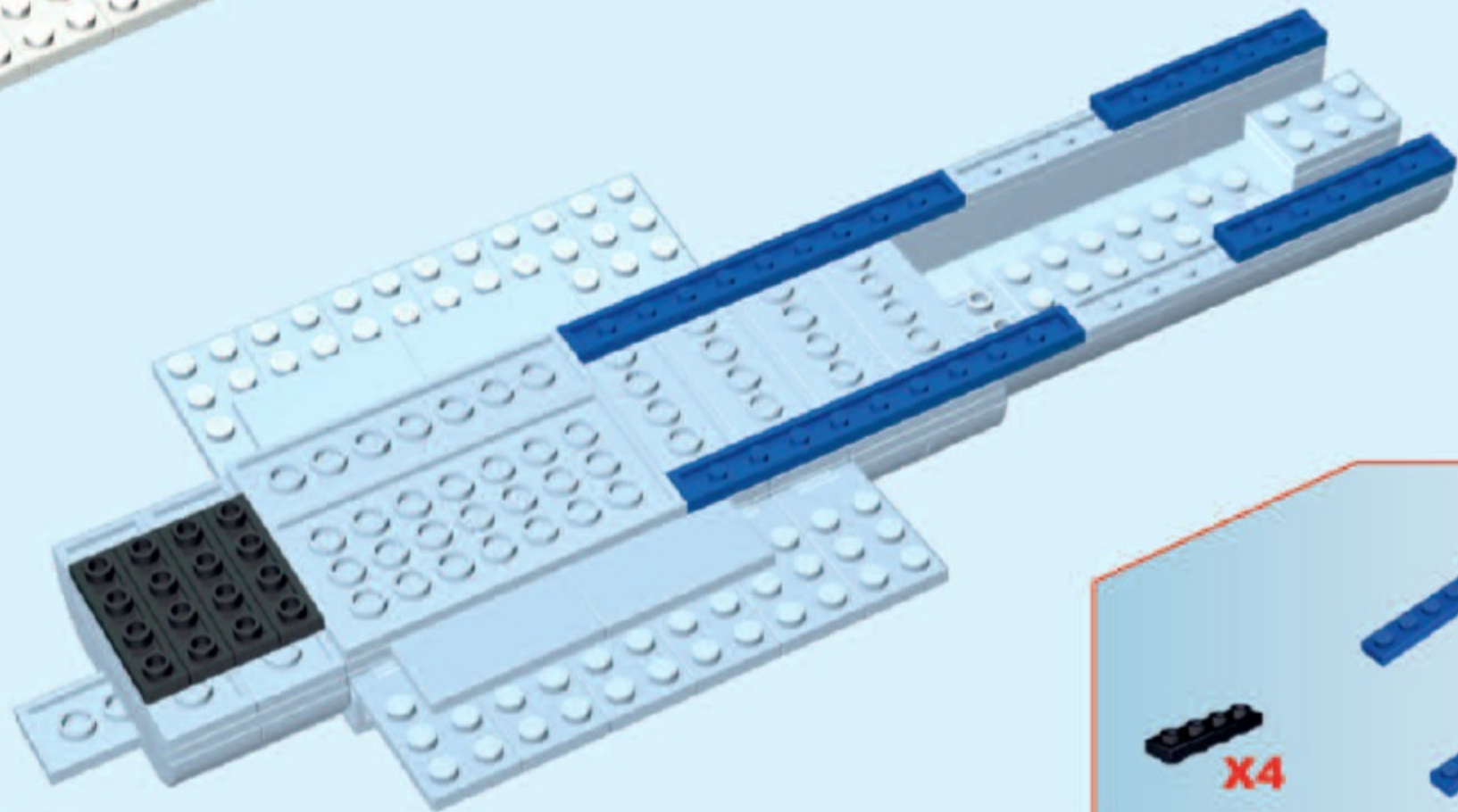

15

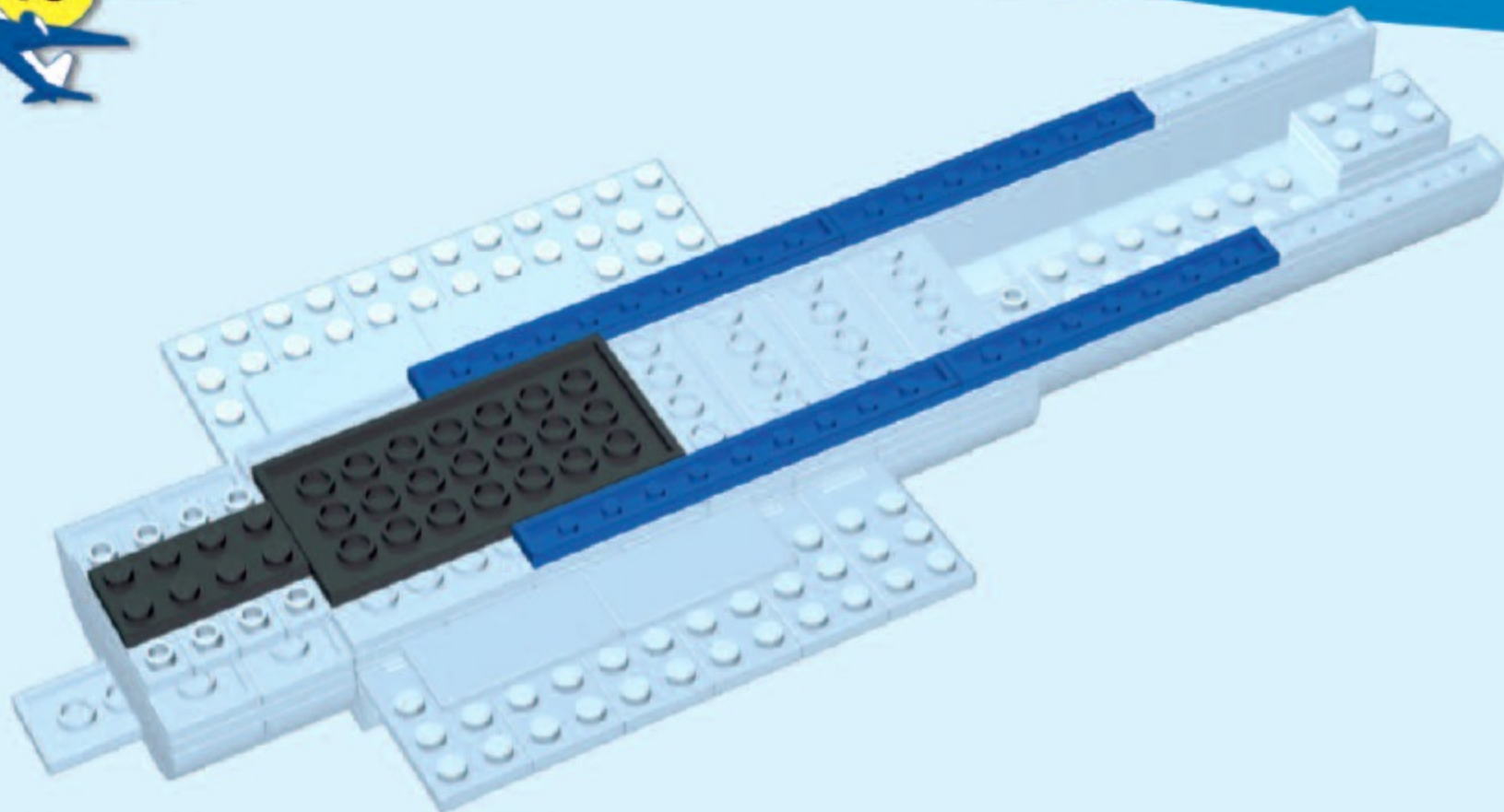

16

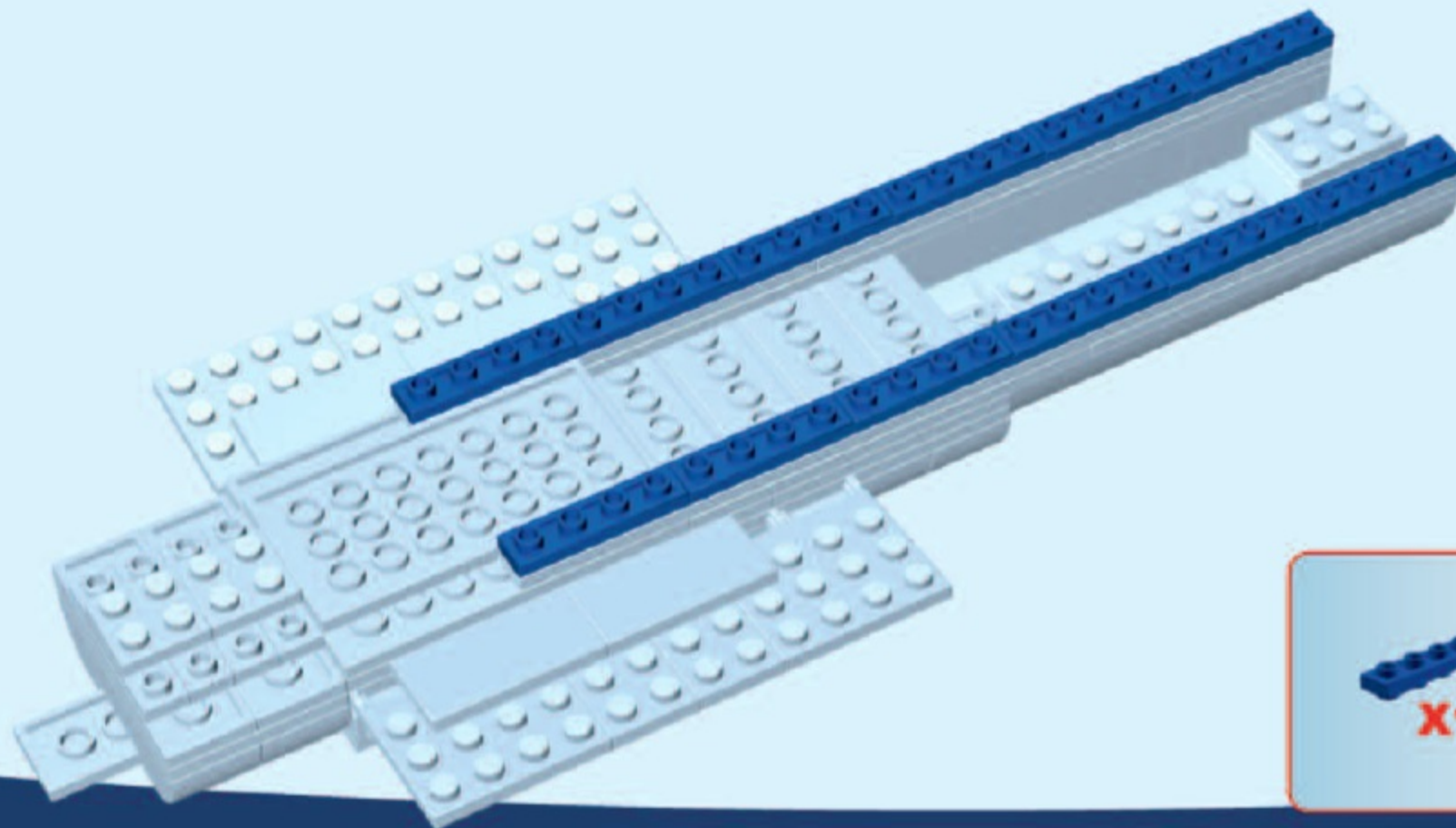



17

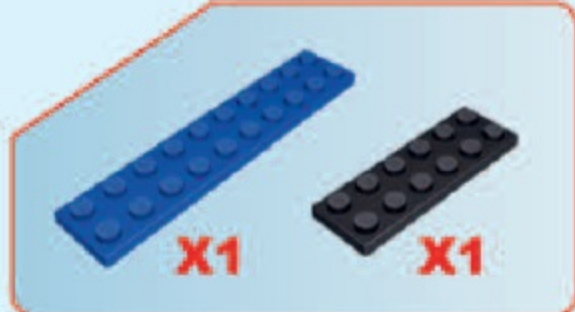

18

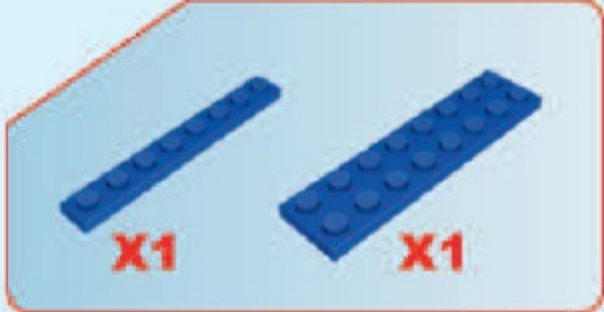

19

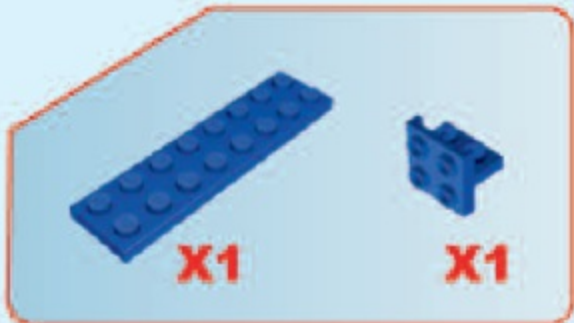

20



21



22



23



24



25

X1 **X1** **X1** **X2**

26

X3 **X1**

27

X2

28

X4

29

X1 **X1** **X2** **X2** **X2**

30

X1 **X1** **X1** **X1**

31

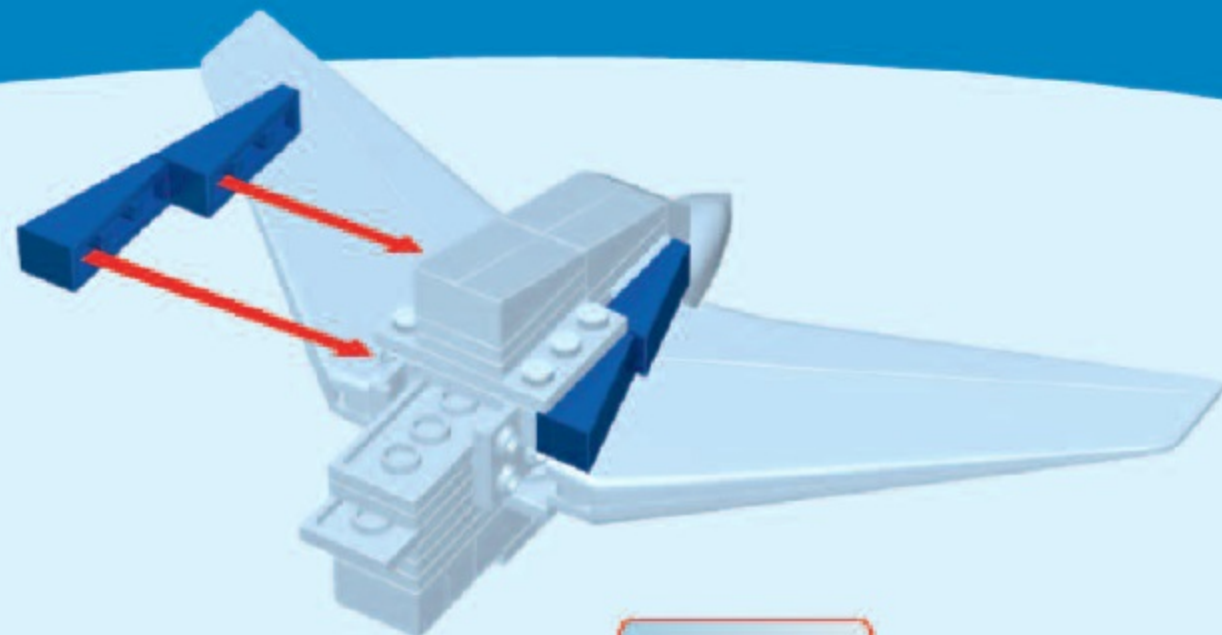

32

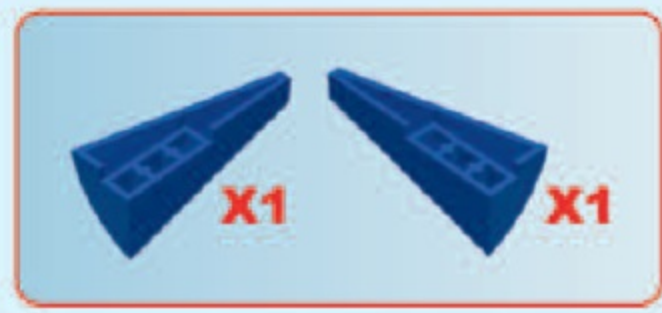

33

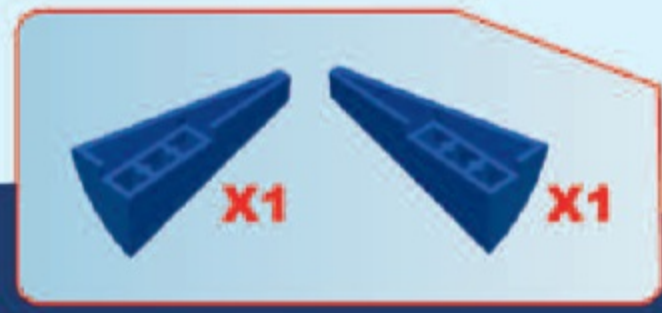

34



35



36



37





(A) (B) + (C)

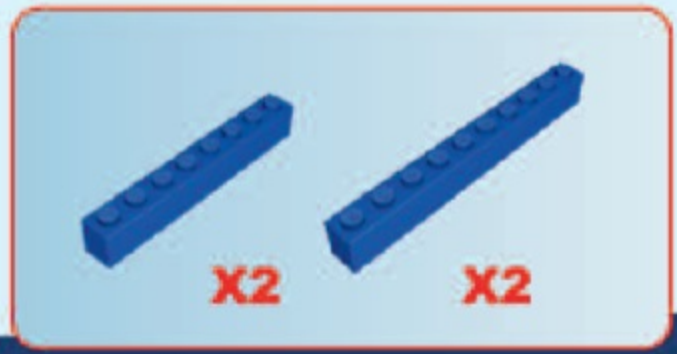
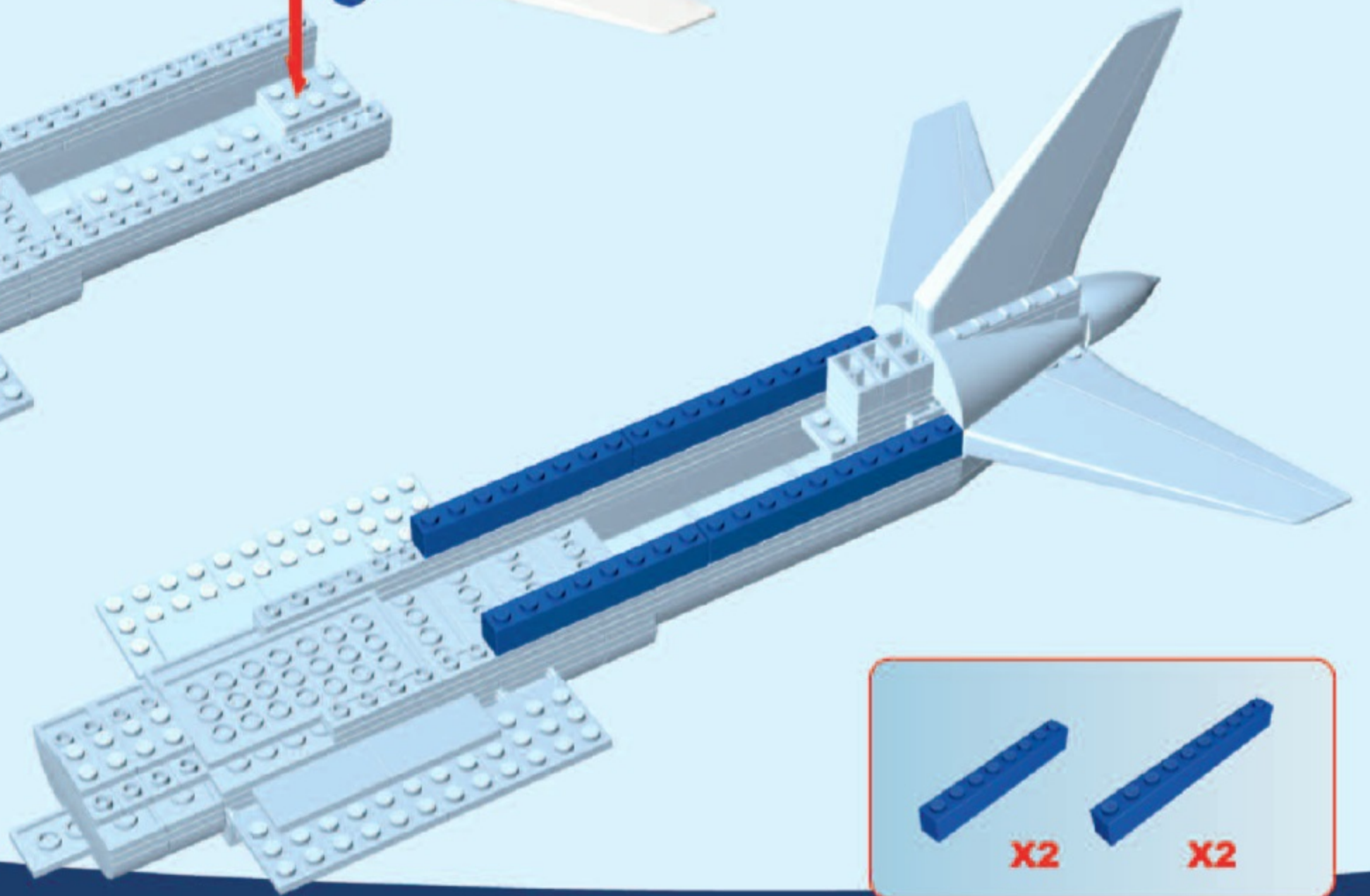
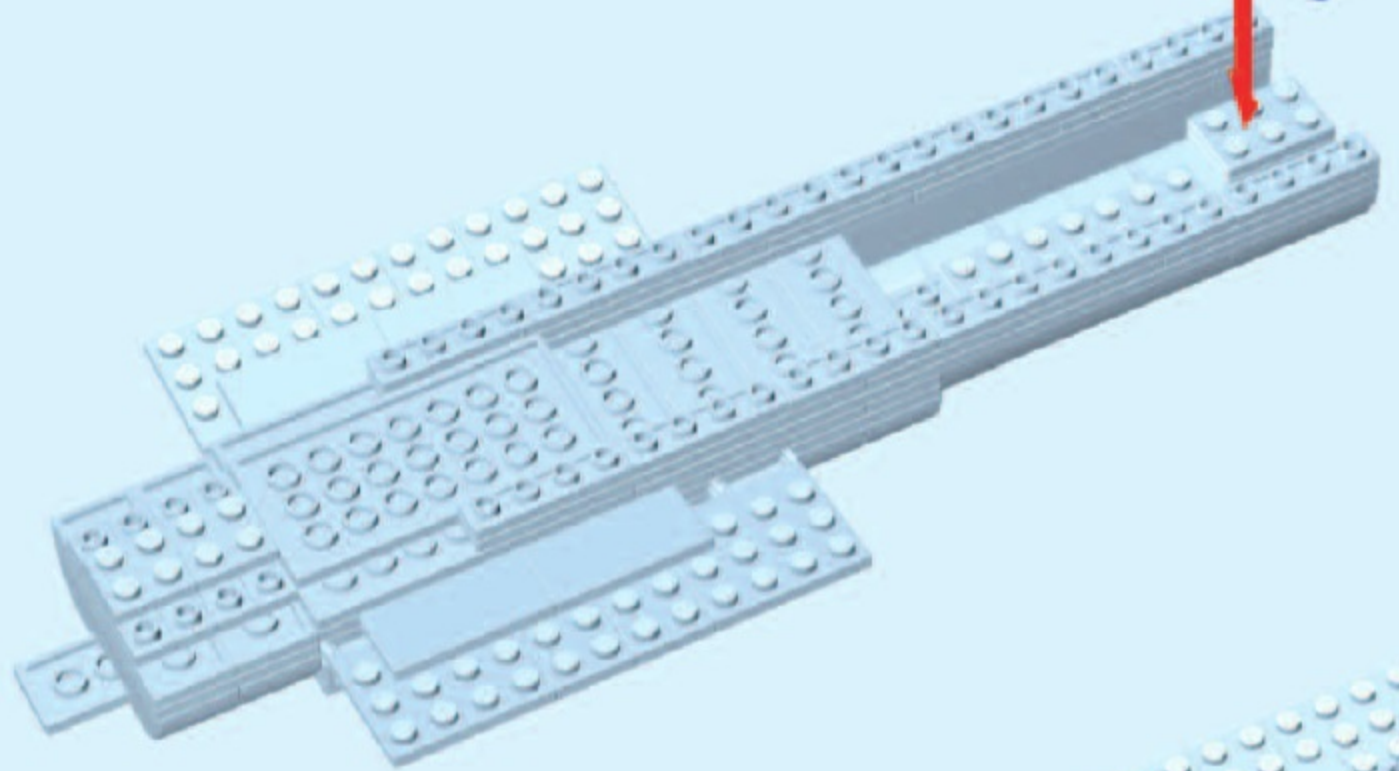

40



X2

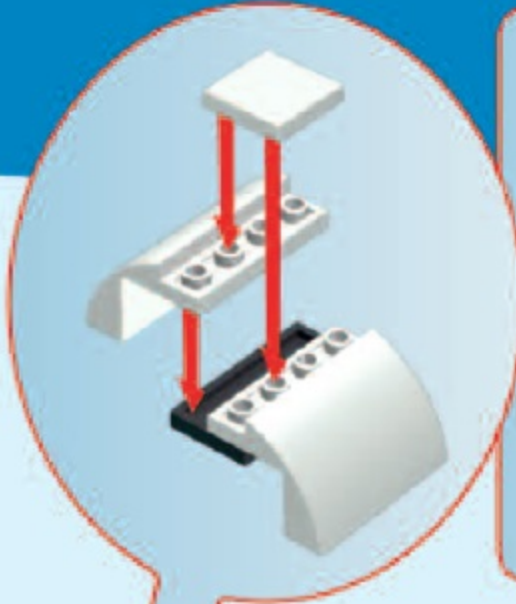
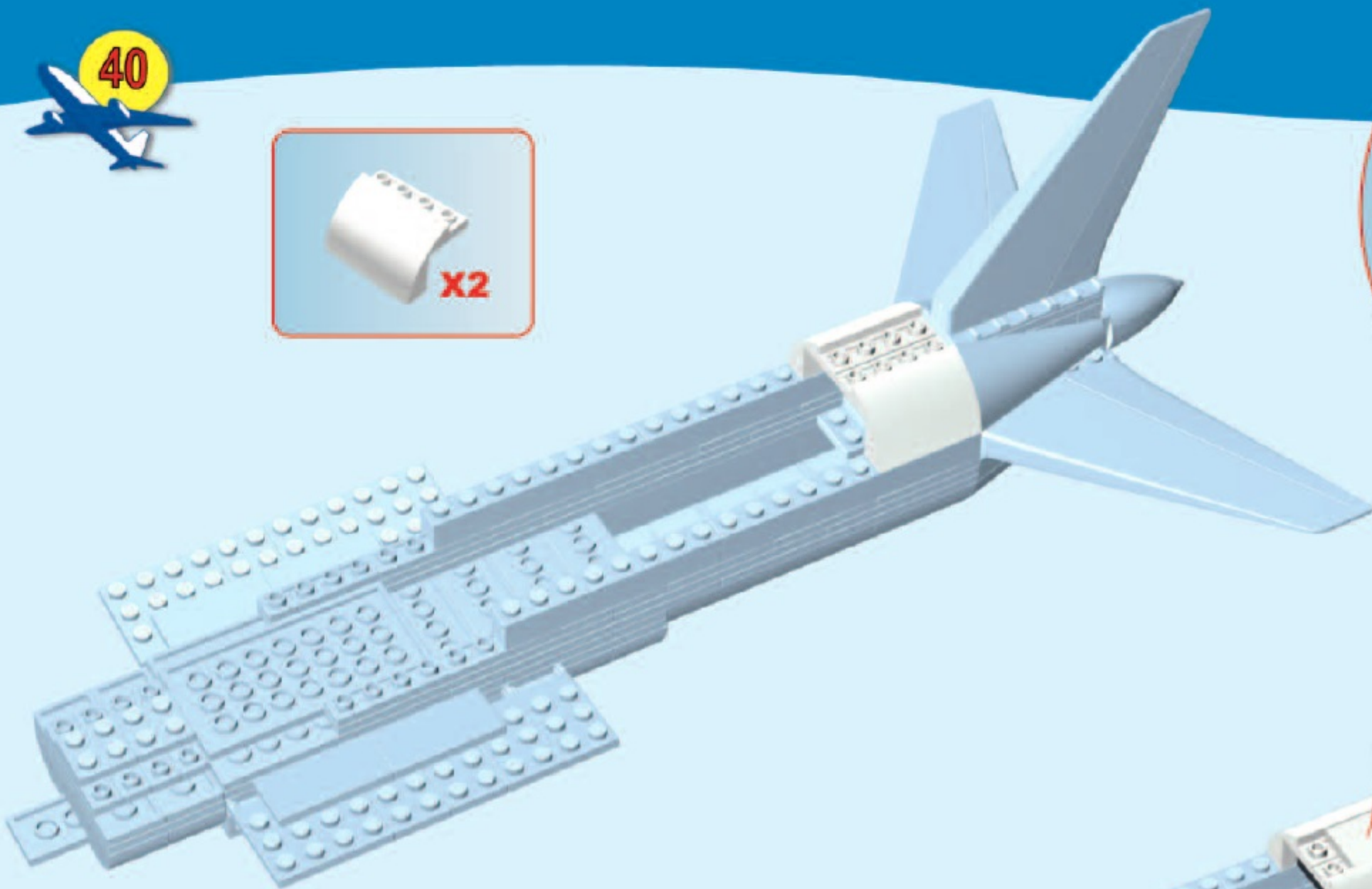

X1

X1

X2

41

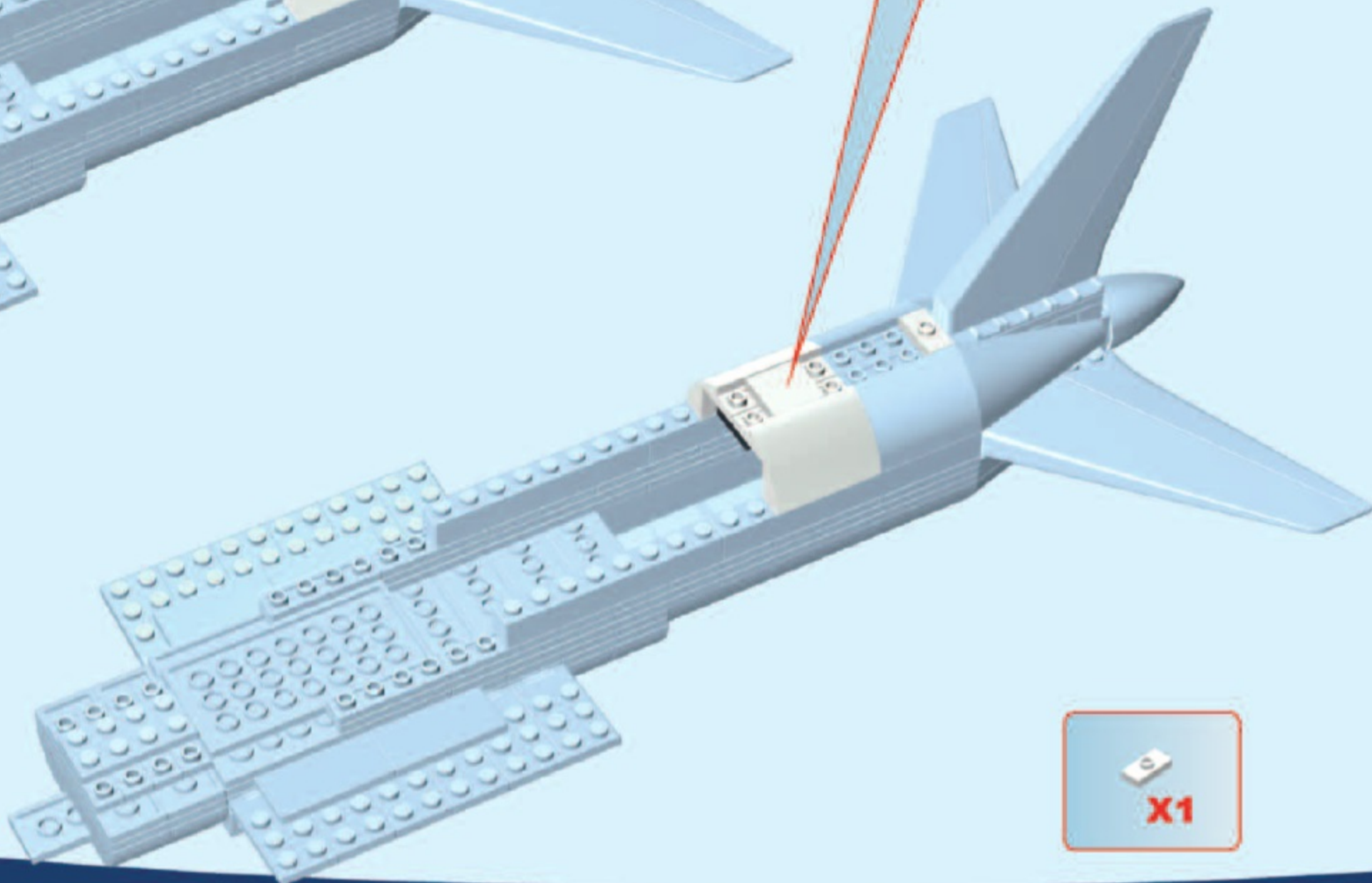

X1

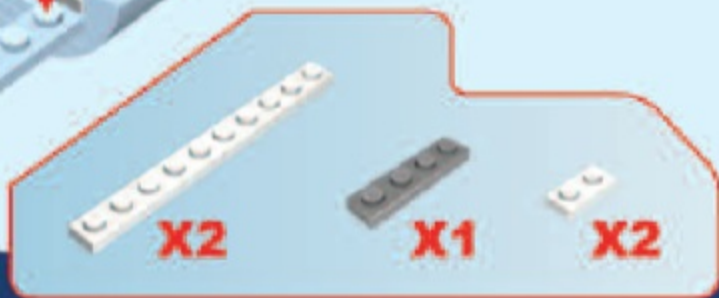
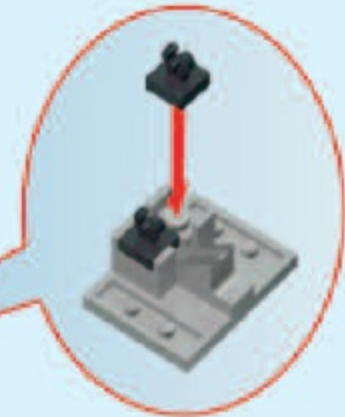
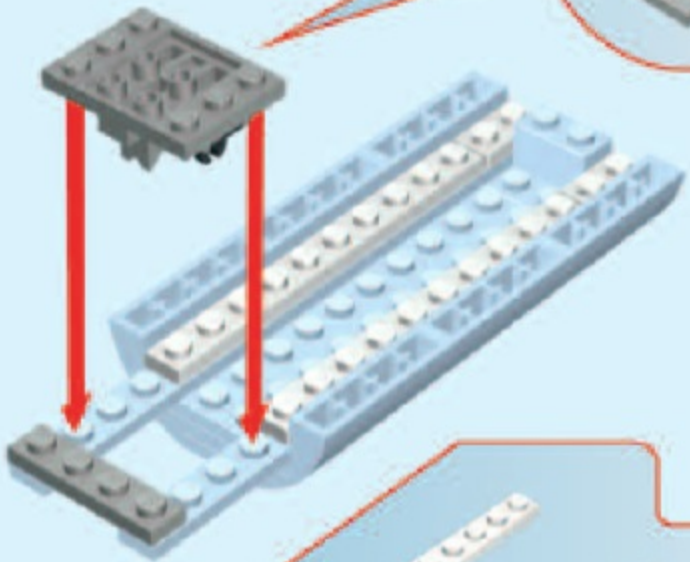
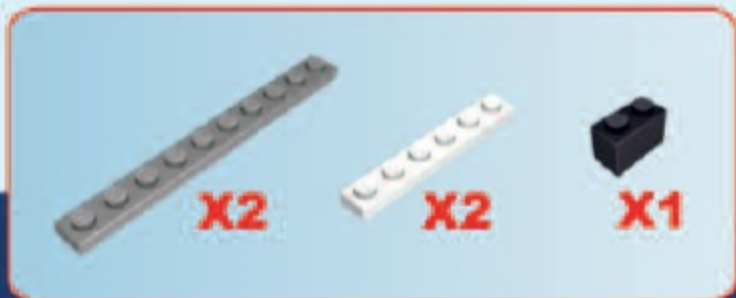
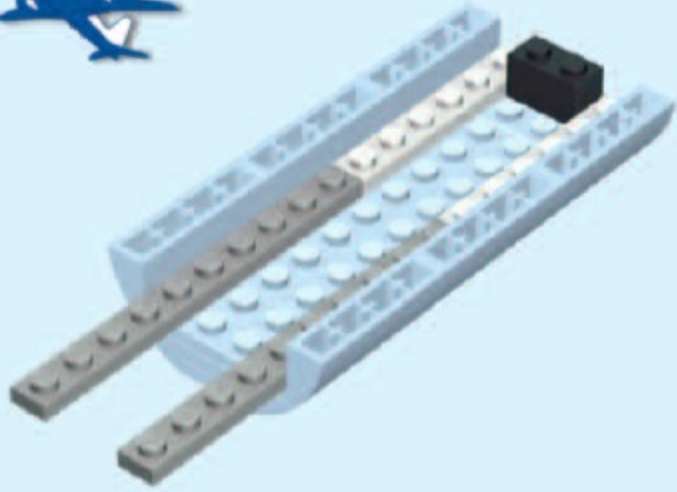
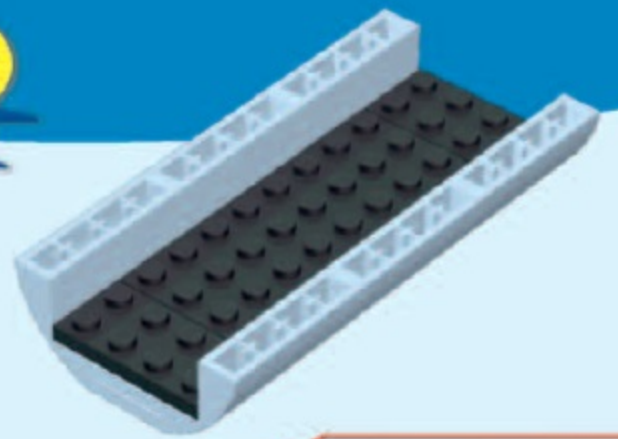
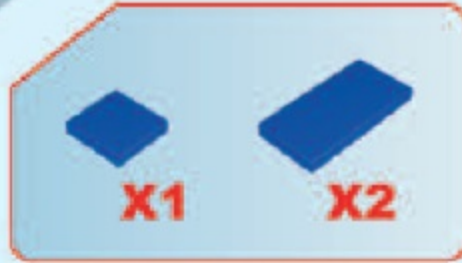
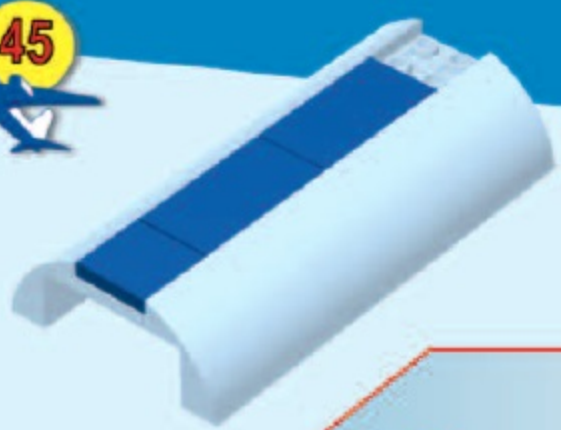

50

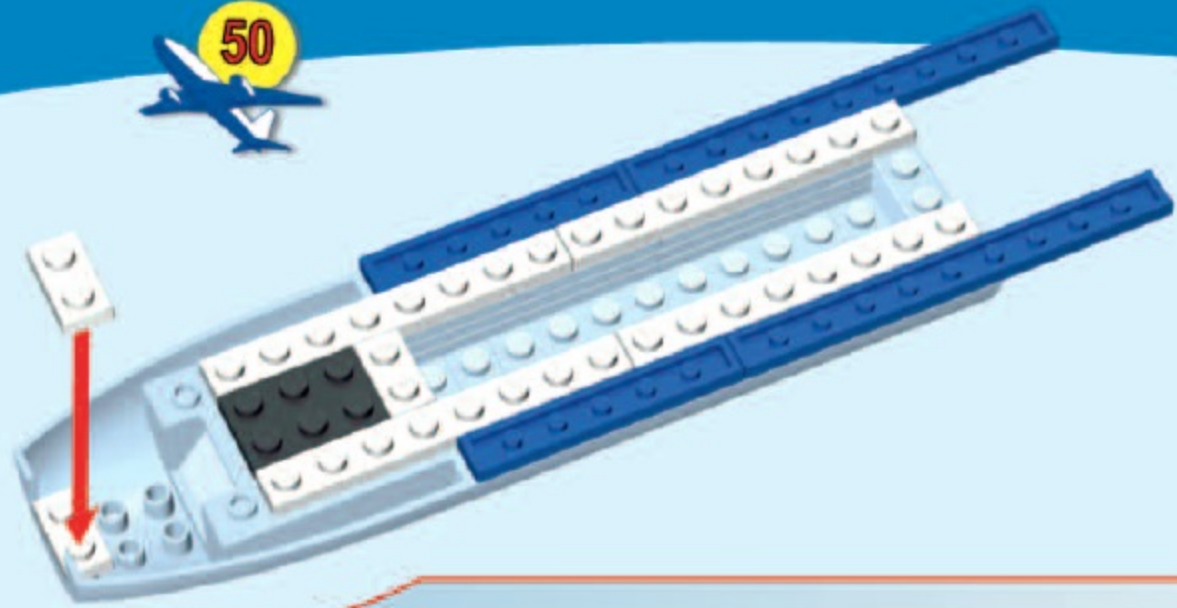

51

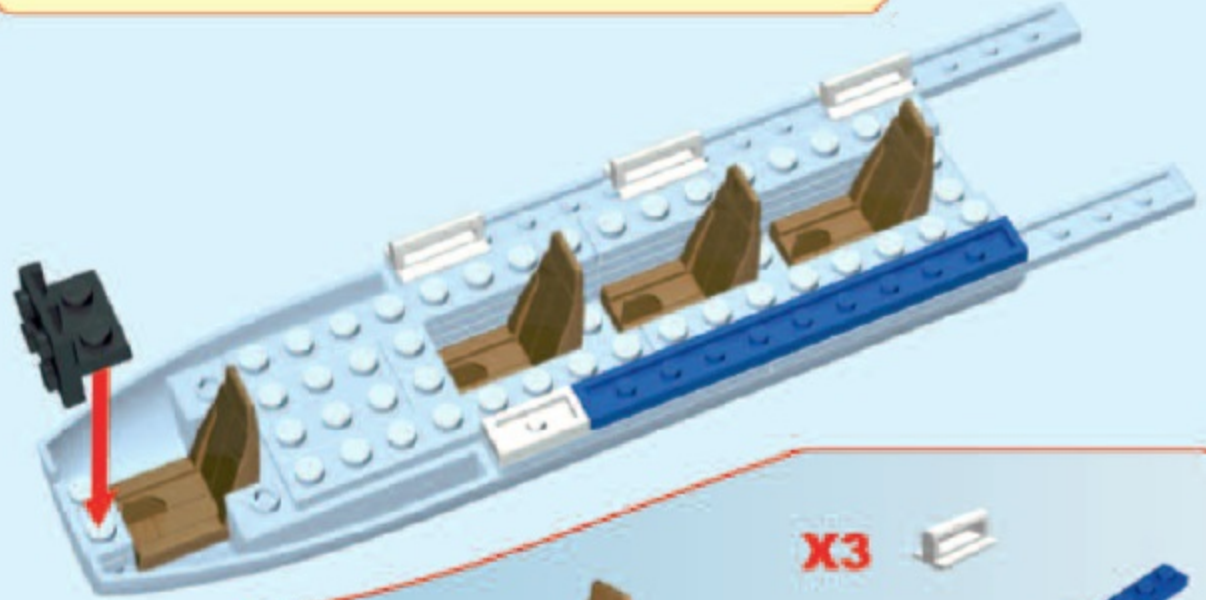
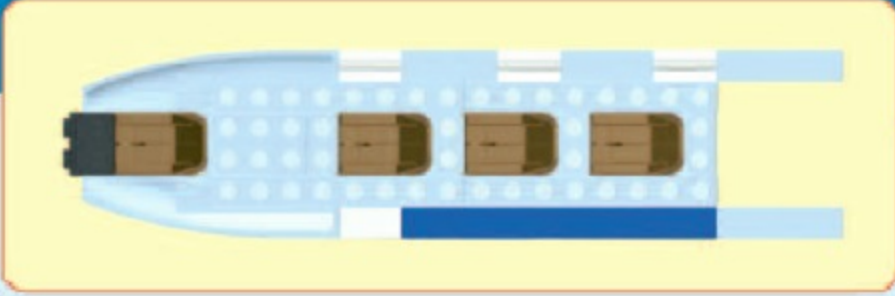

52

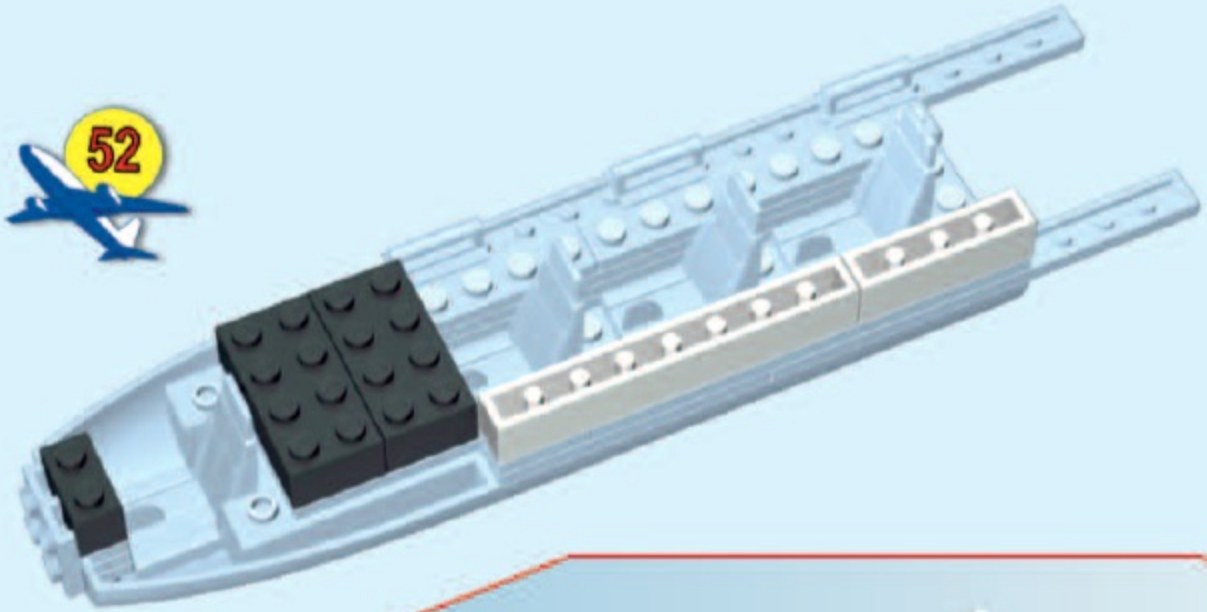

53

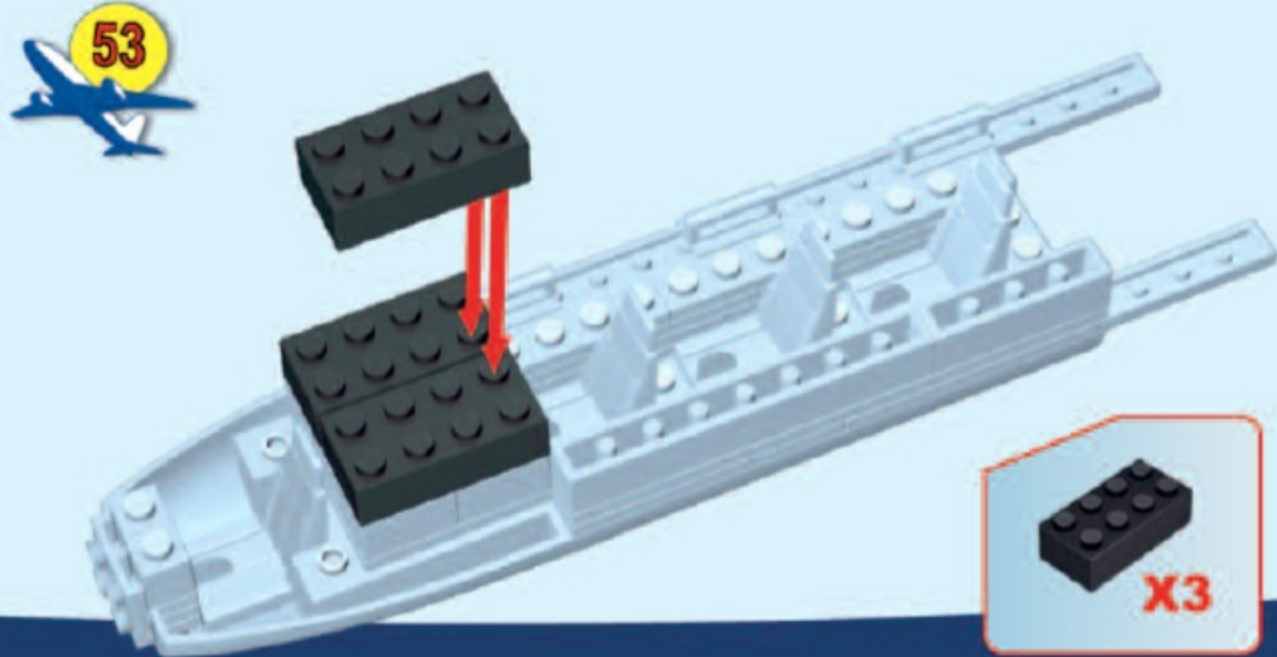

54

A
B C + D

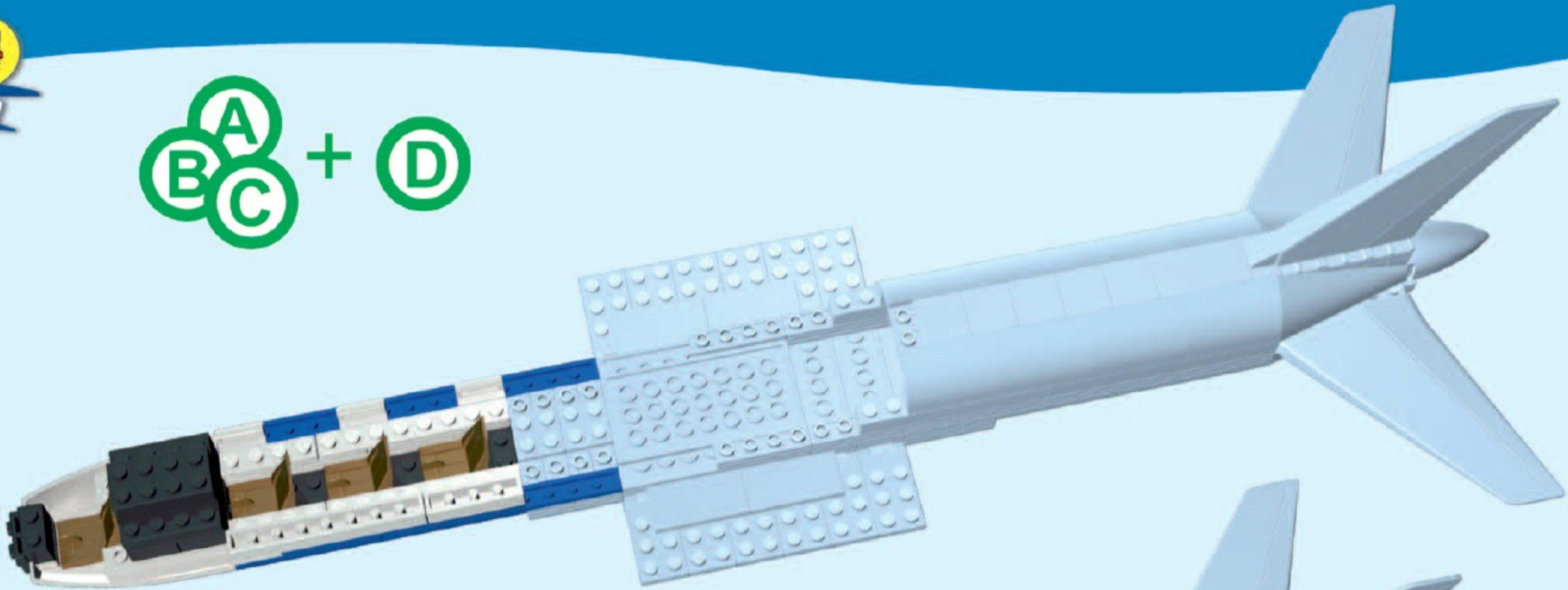

55

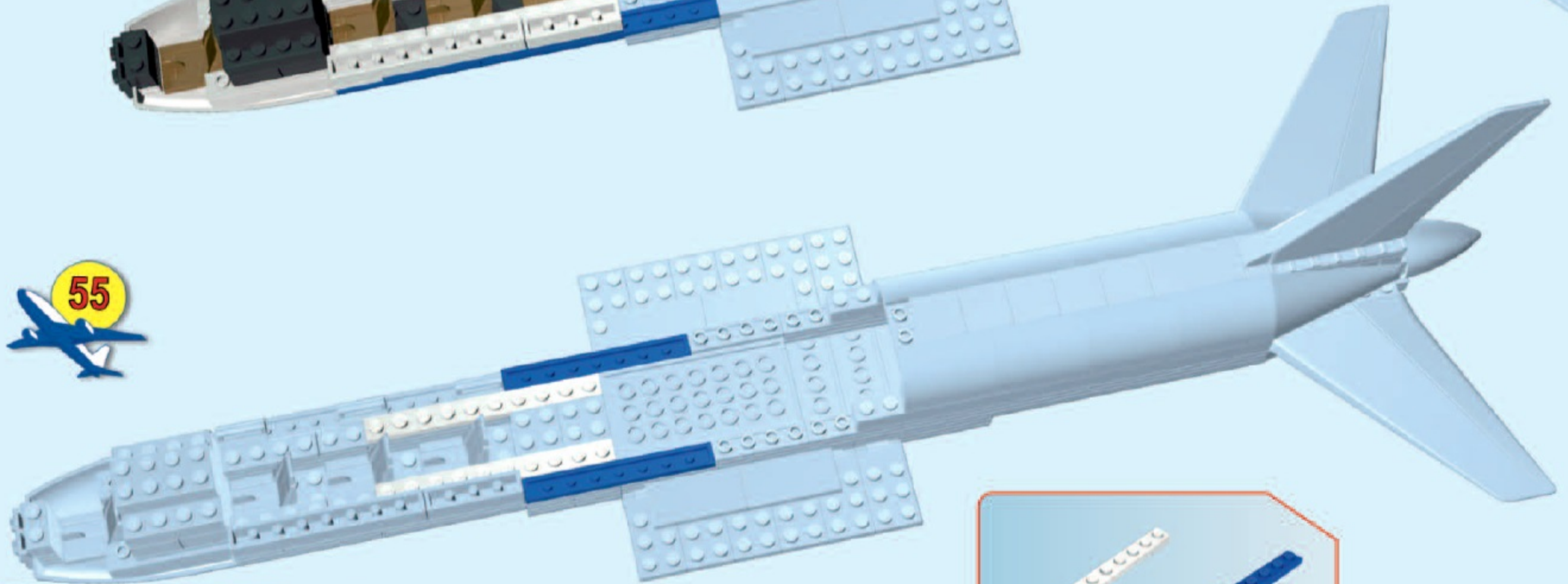

56

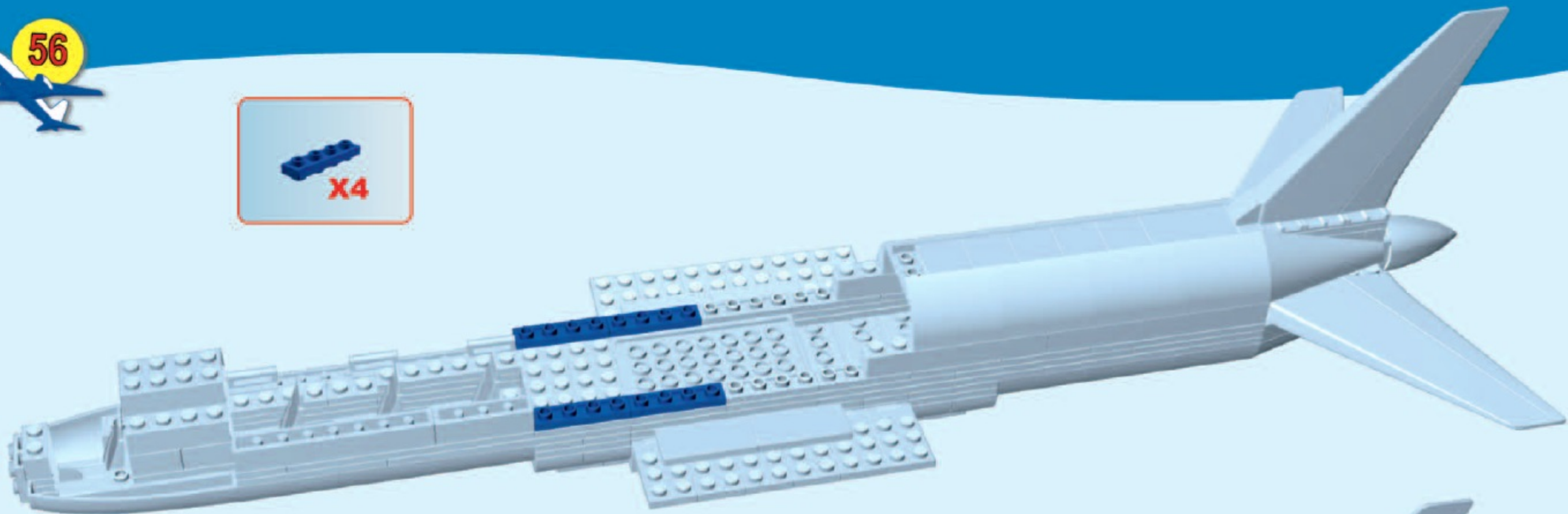

57

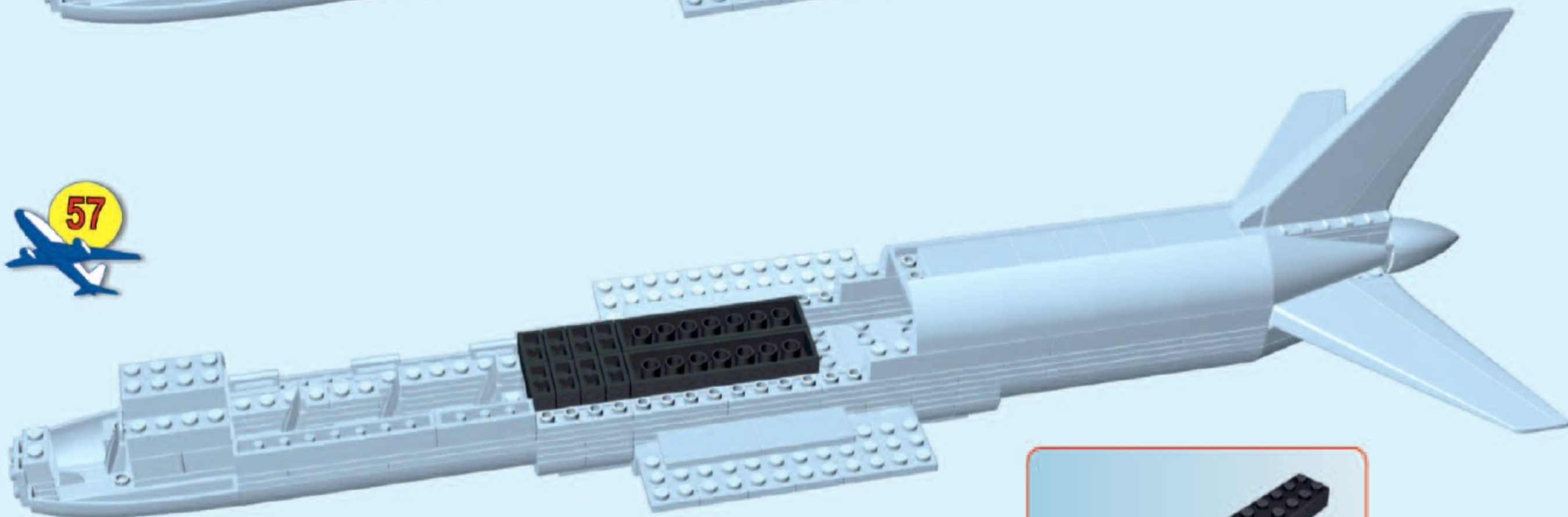

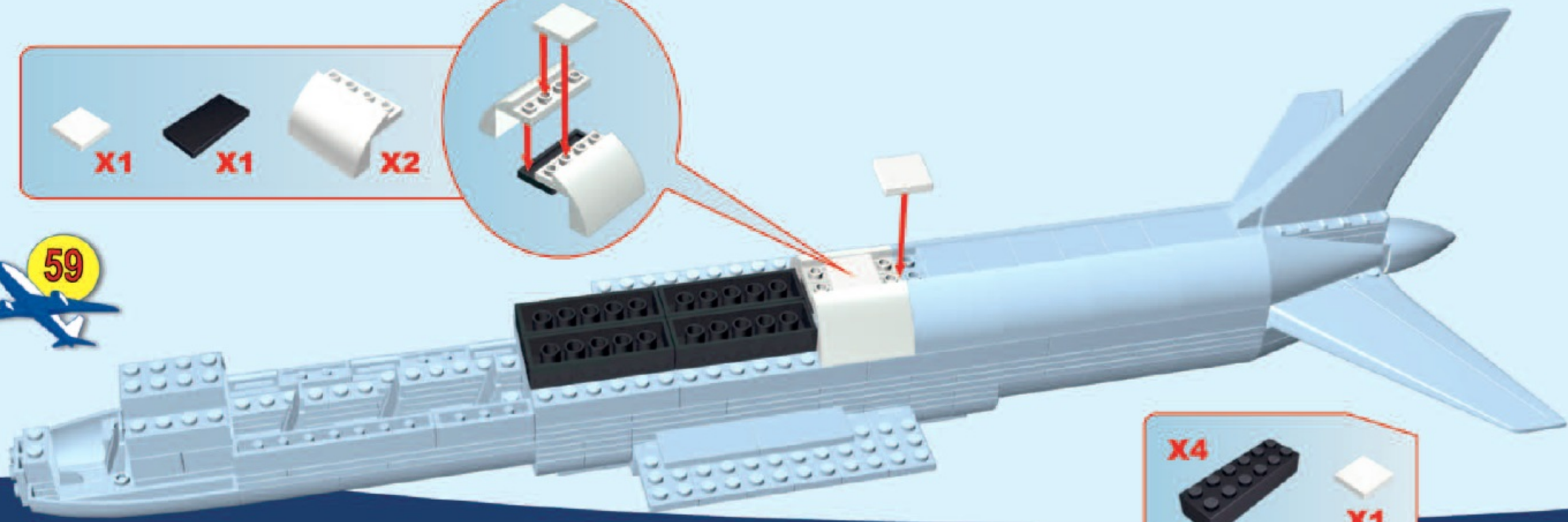
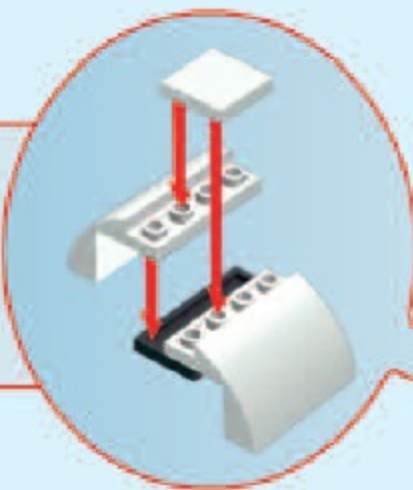
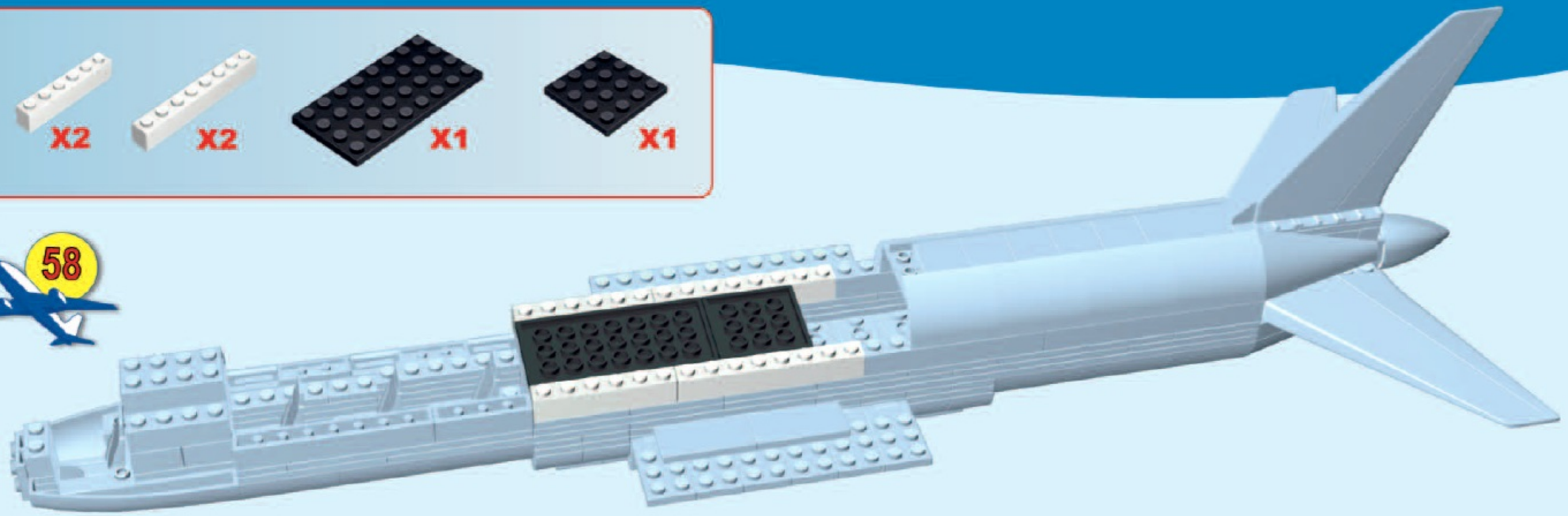

60

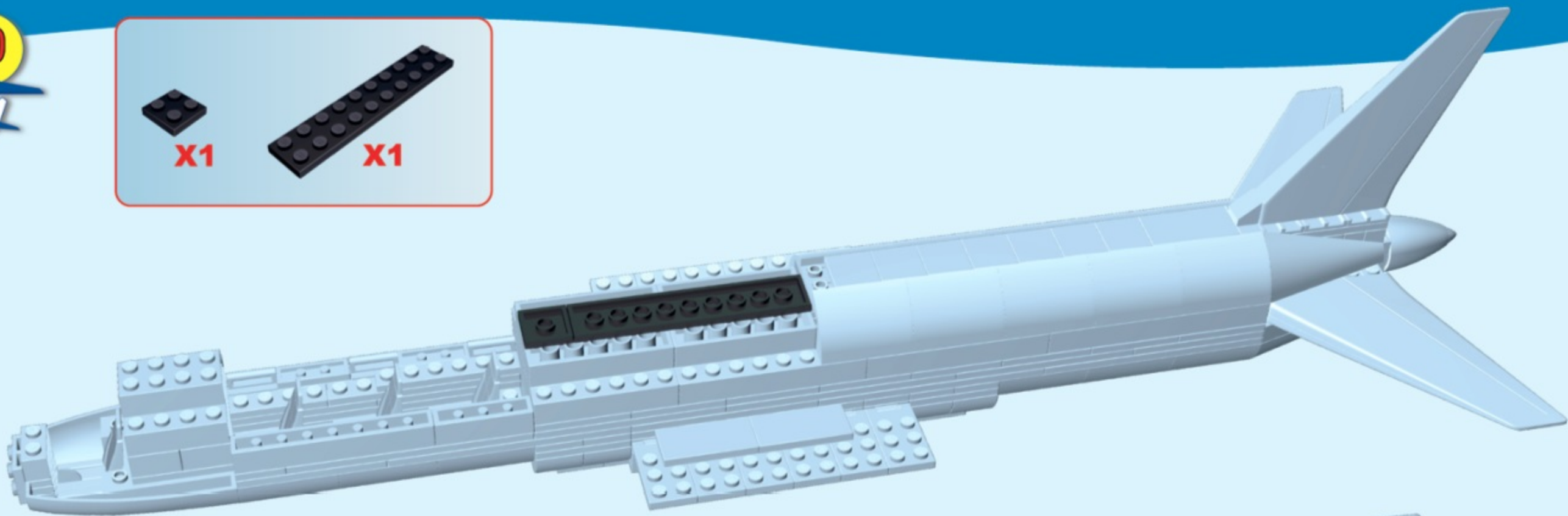

61

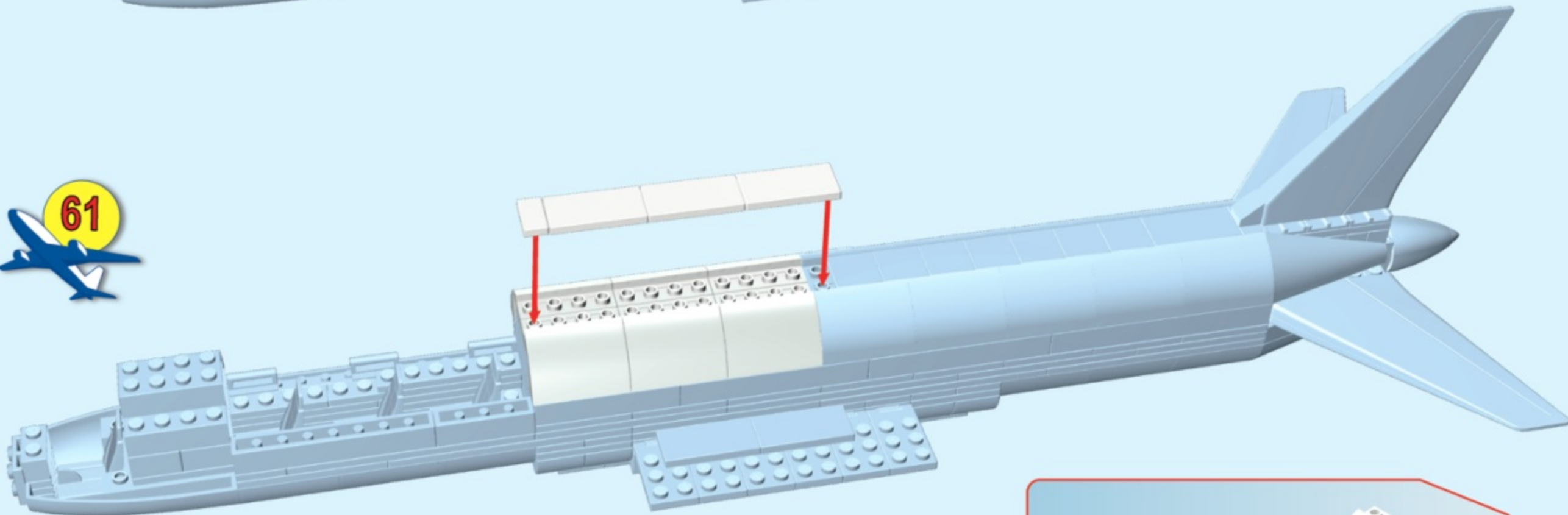
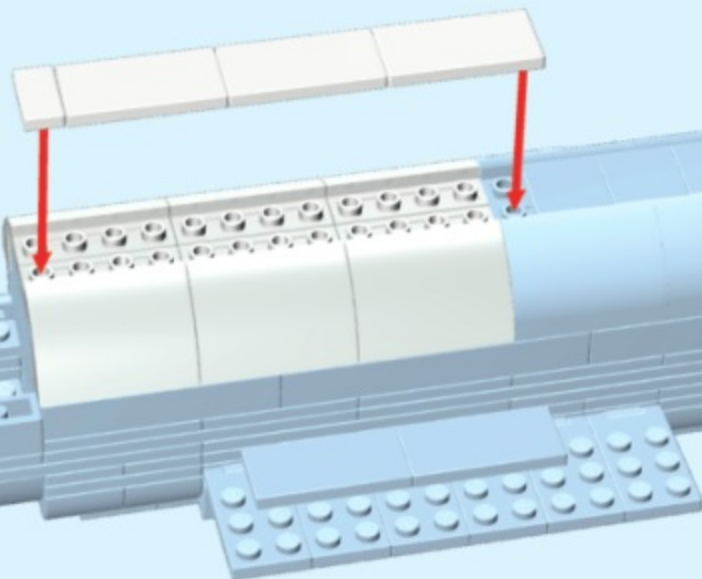

X1

X3

X6

69

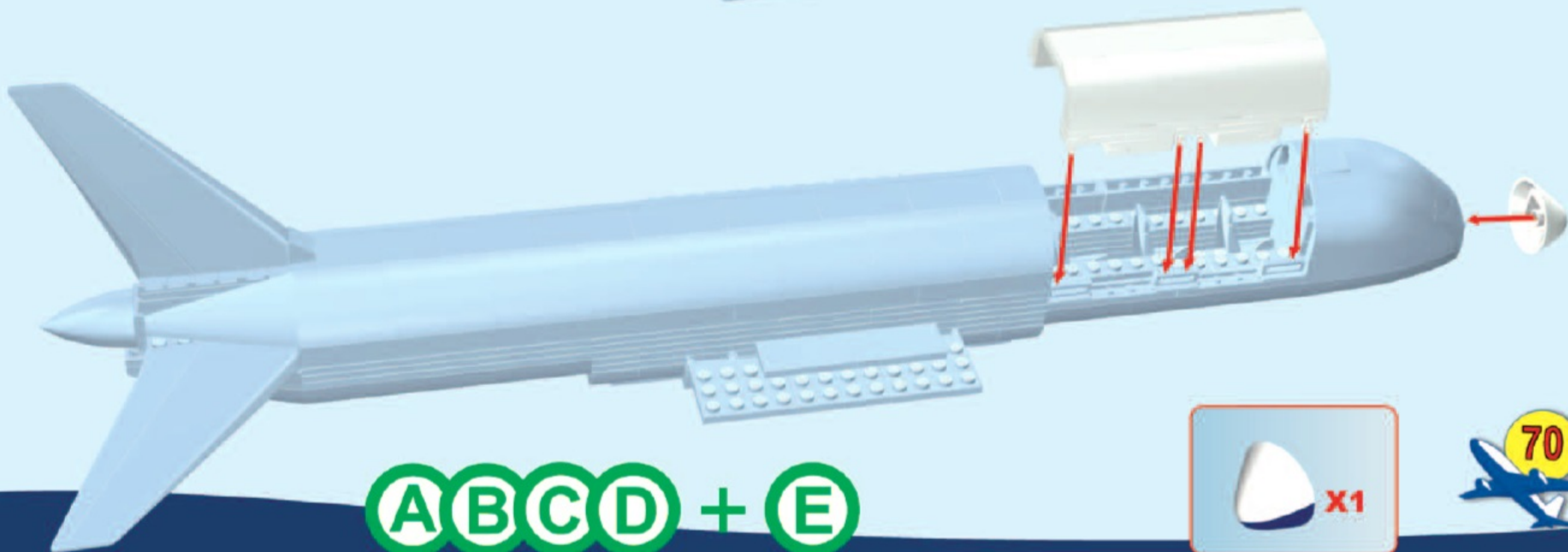
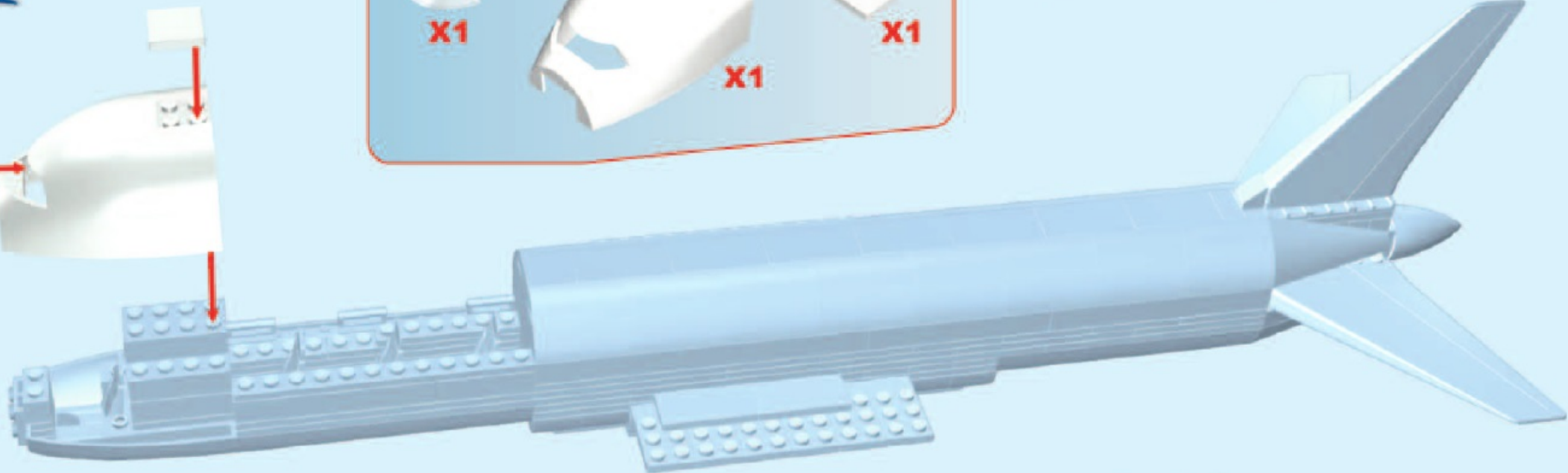
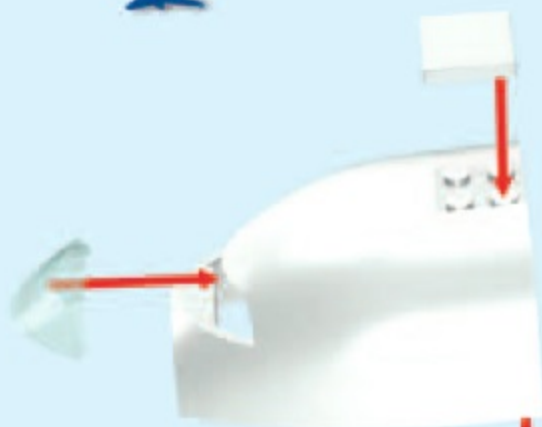

A B C D + E



70



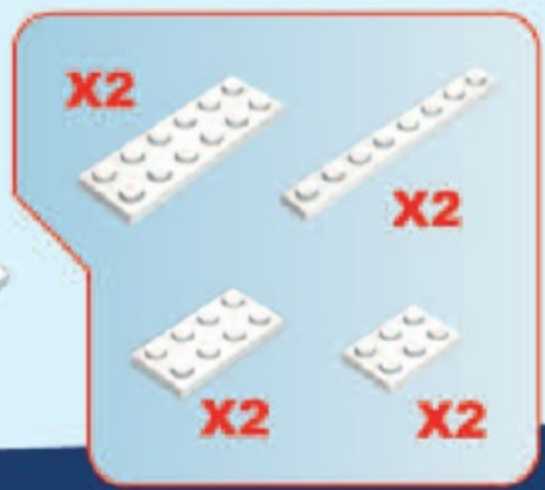
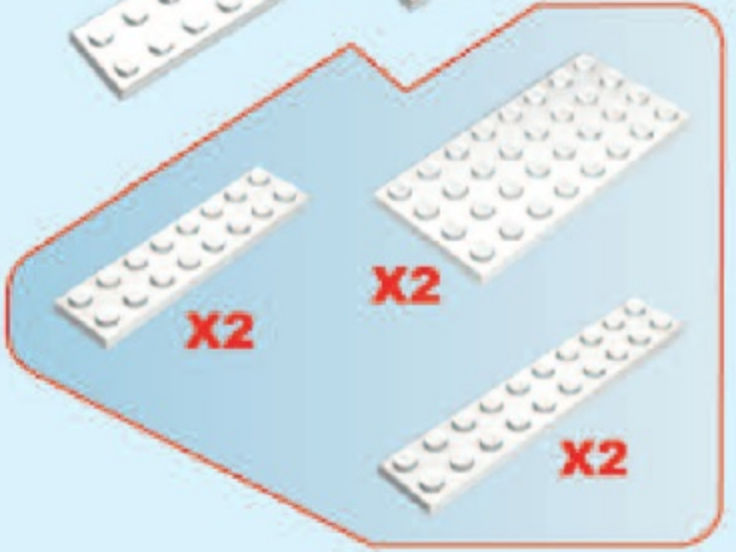
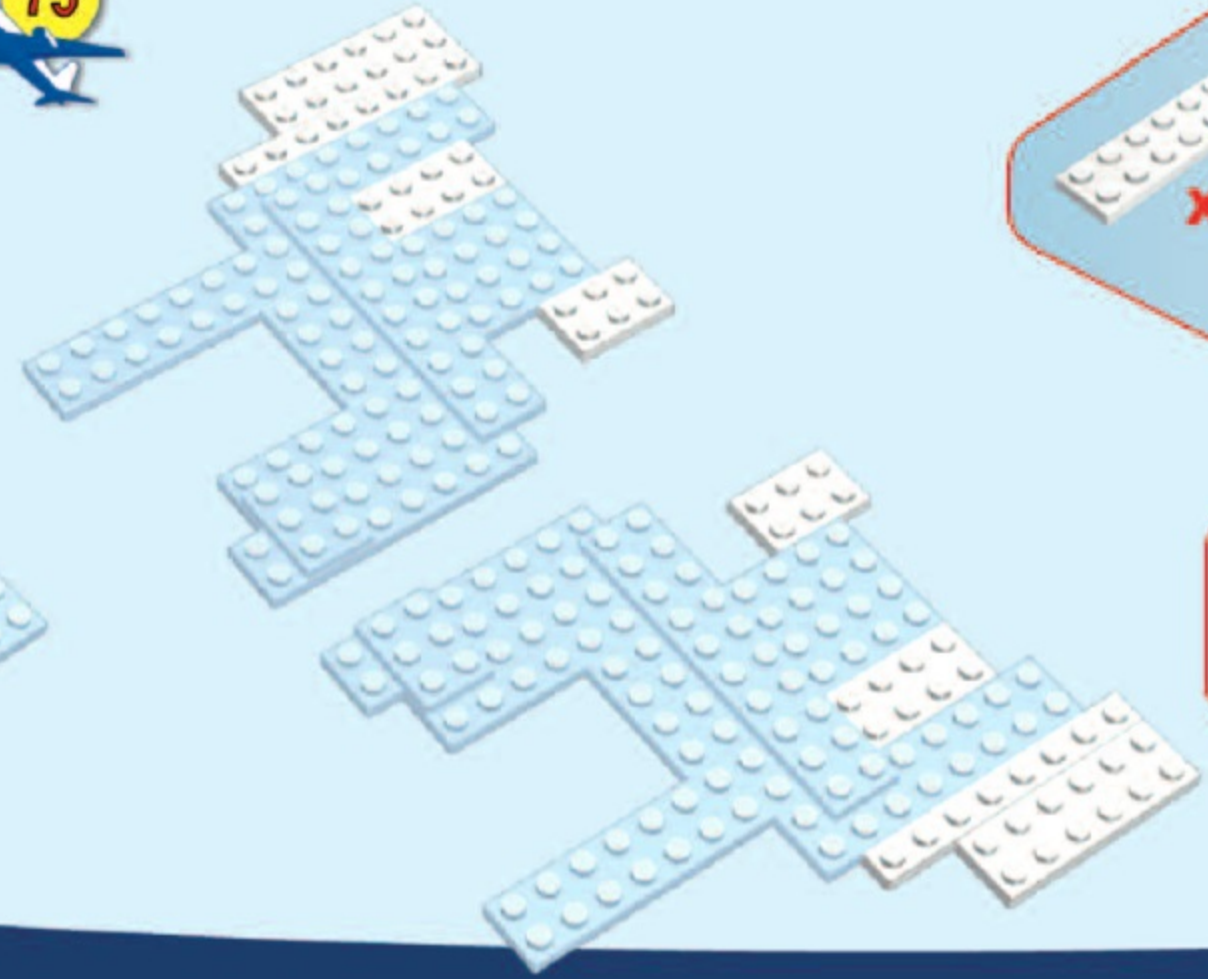
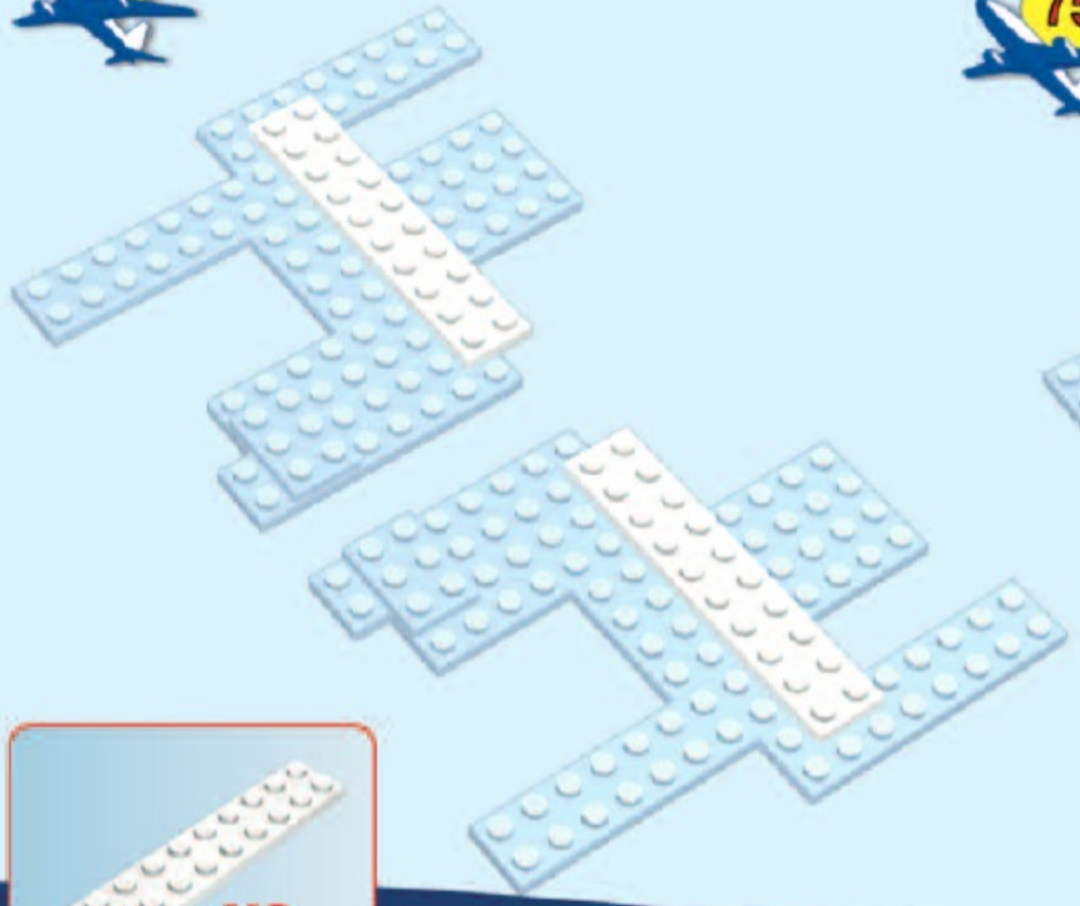
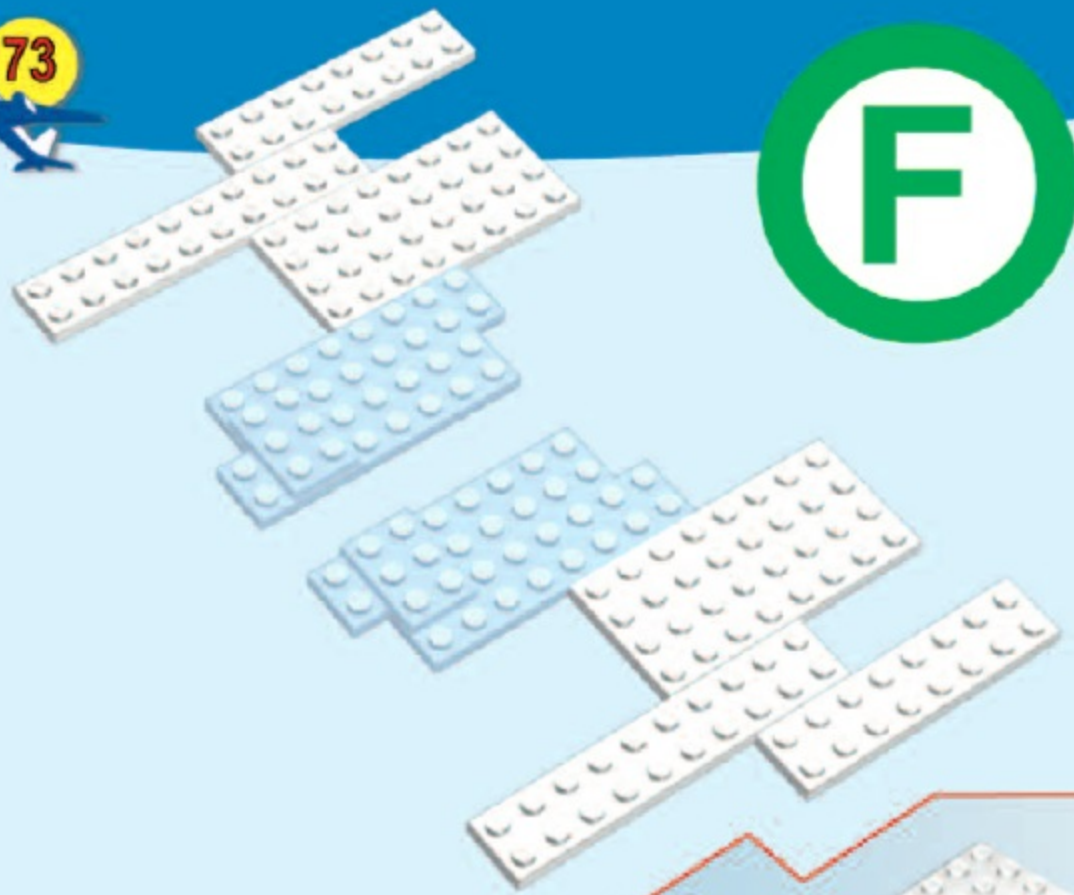
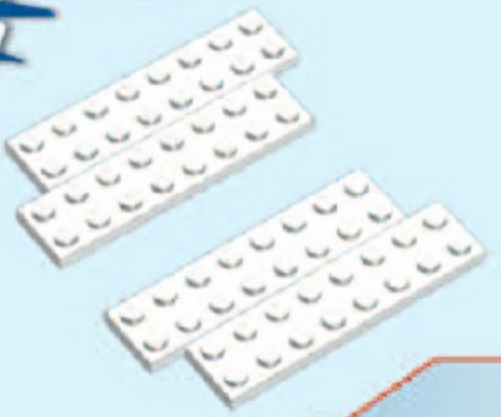

76

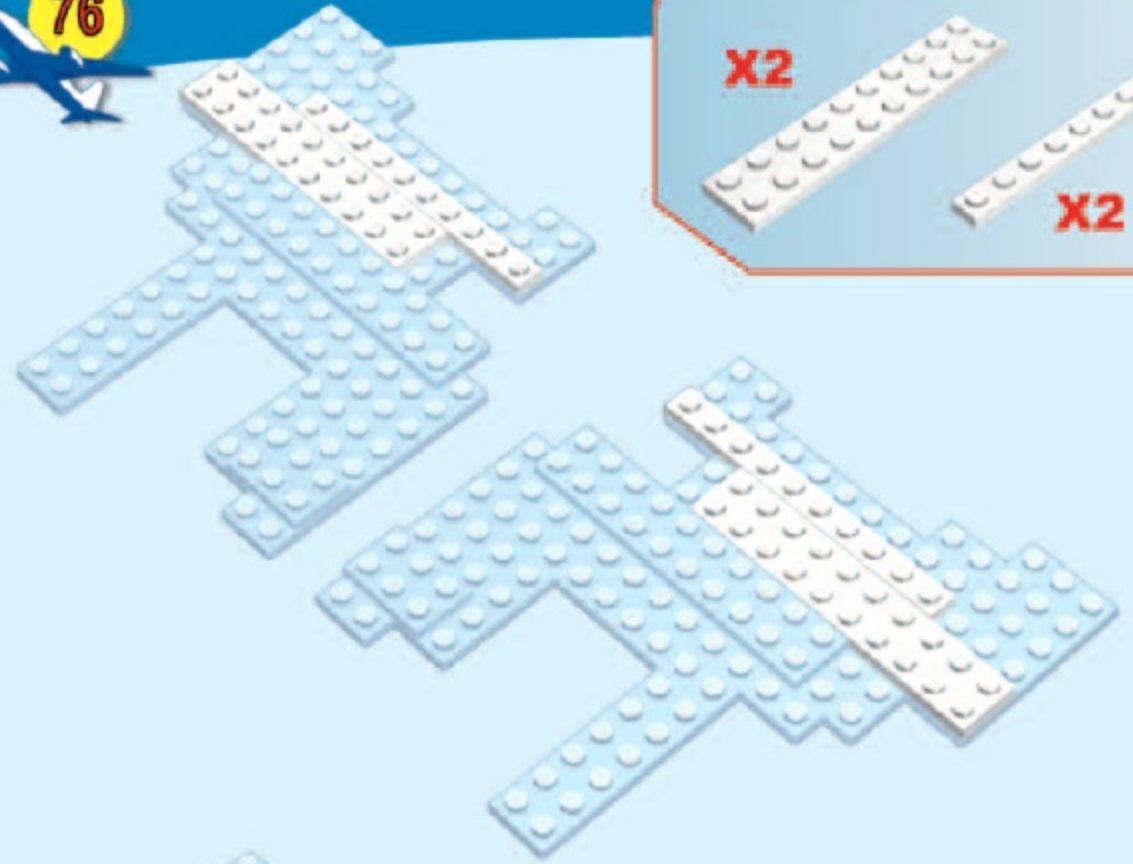

77

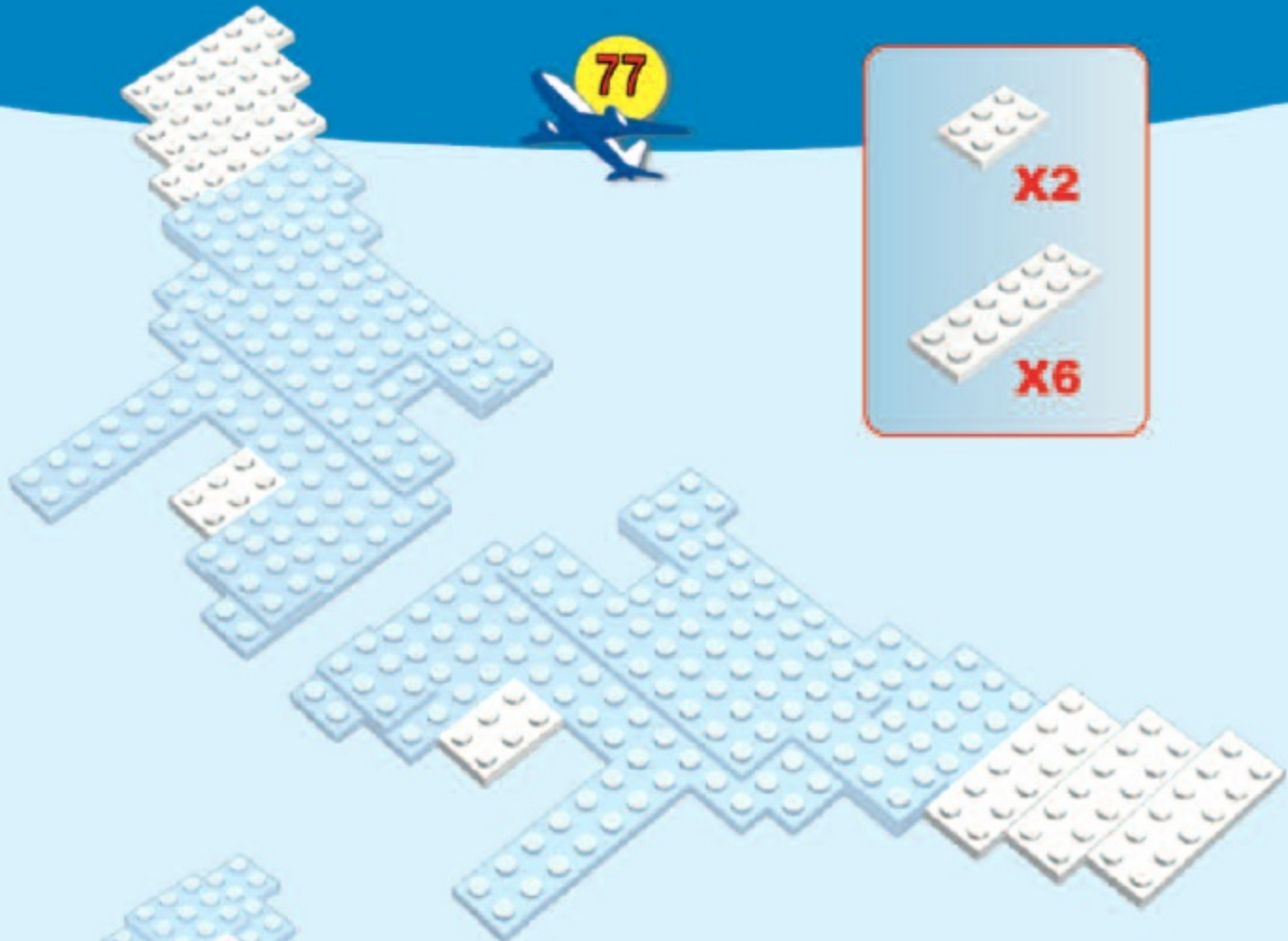

78

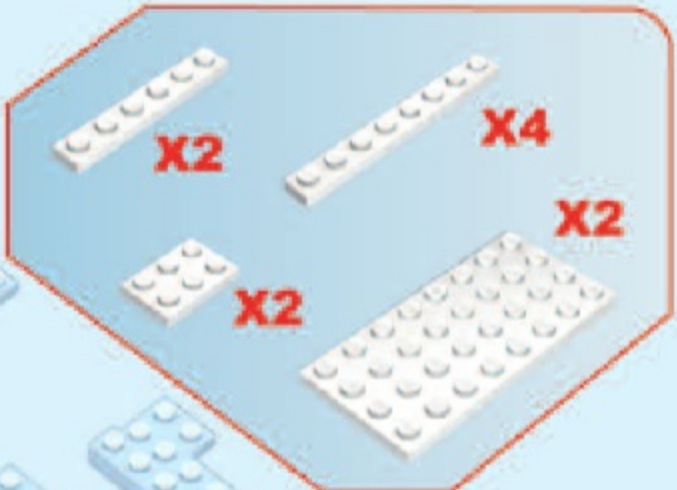
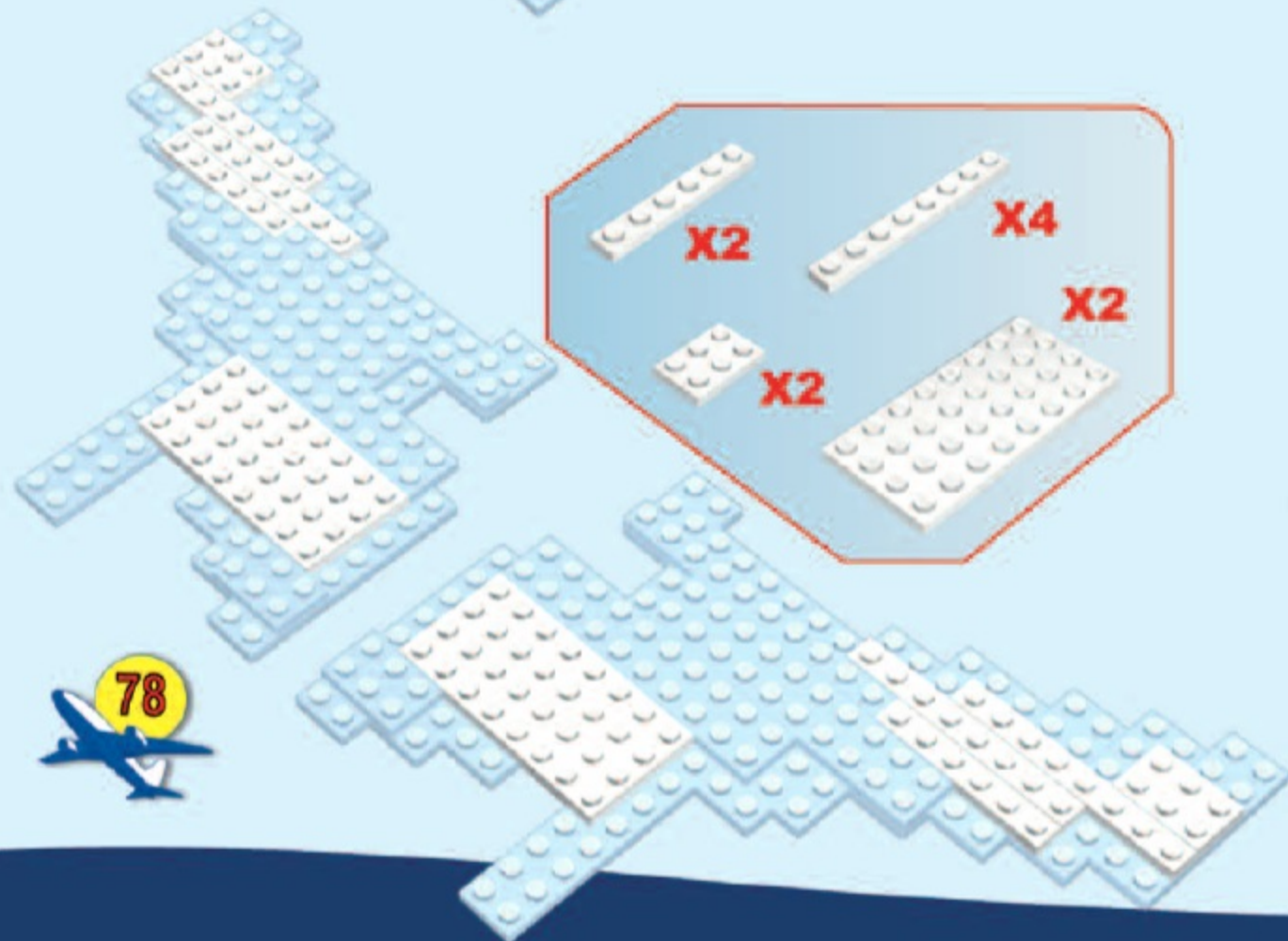

79



80

81

82

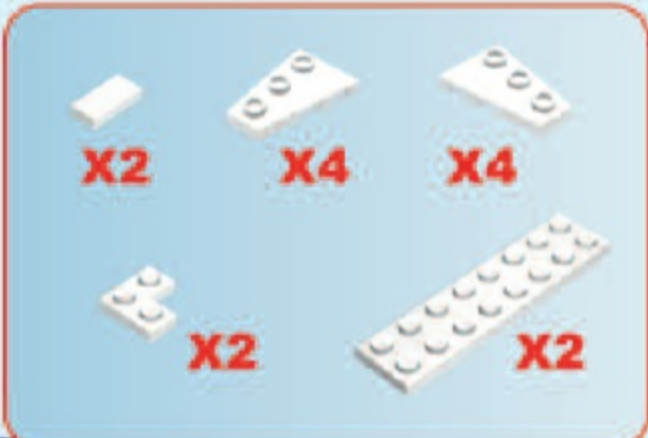
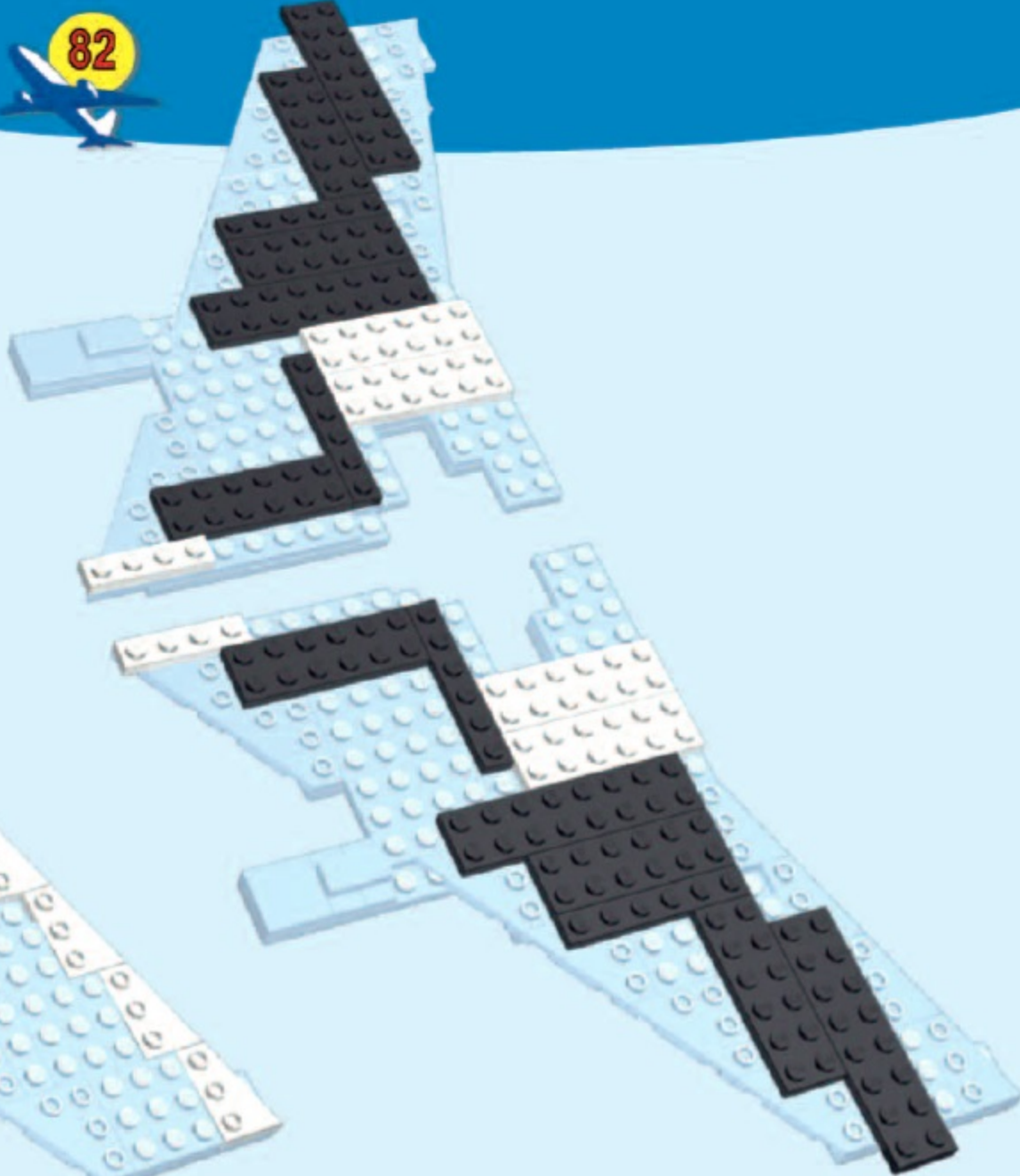
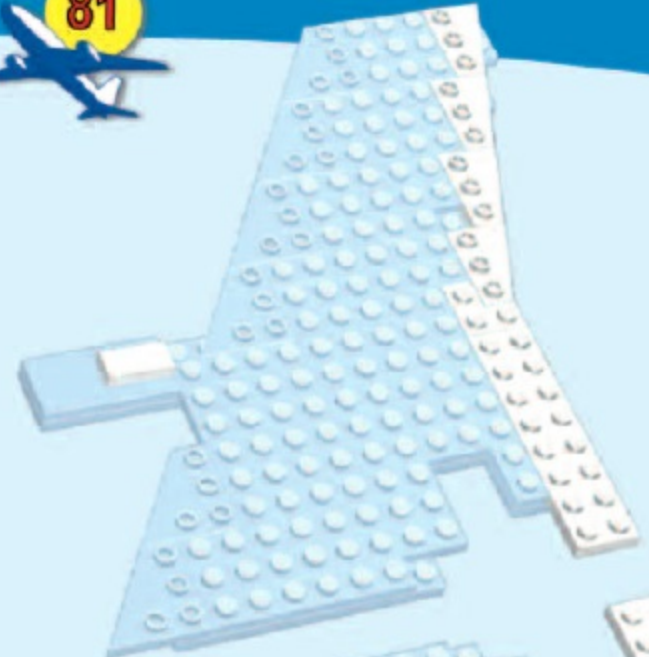
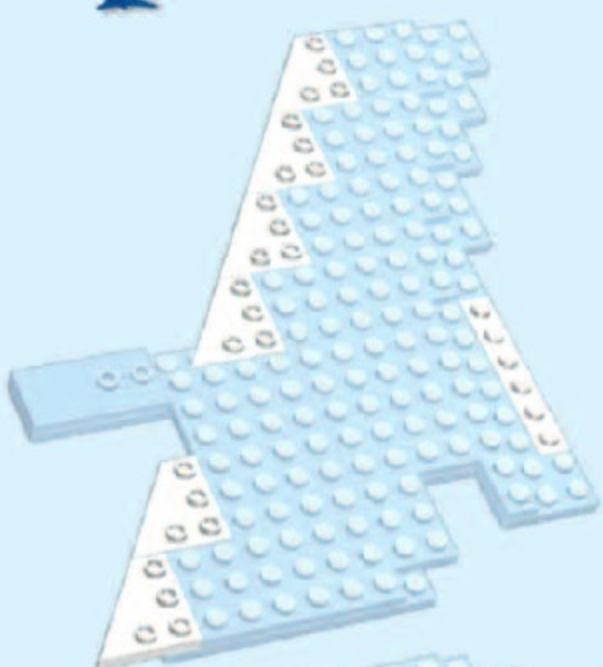

83



84



85

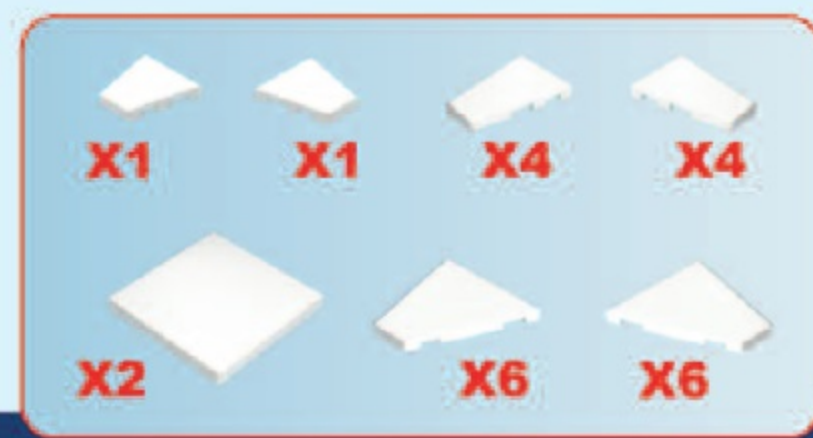
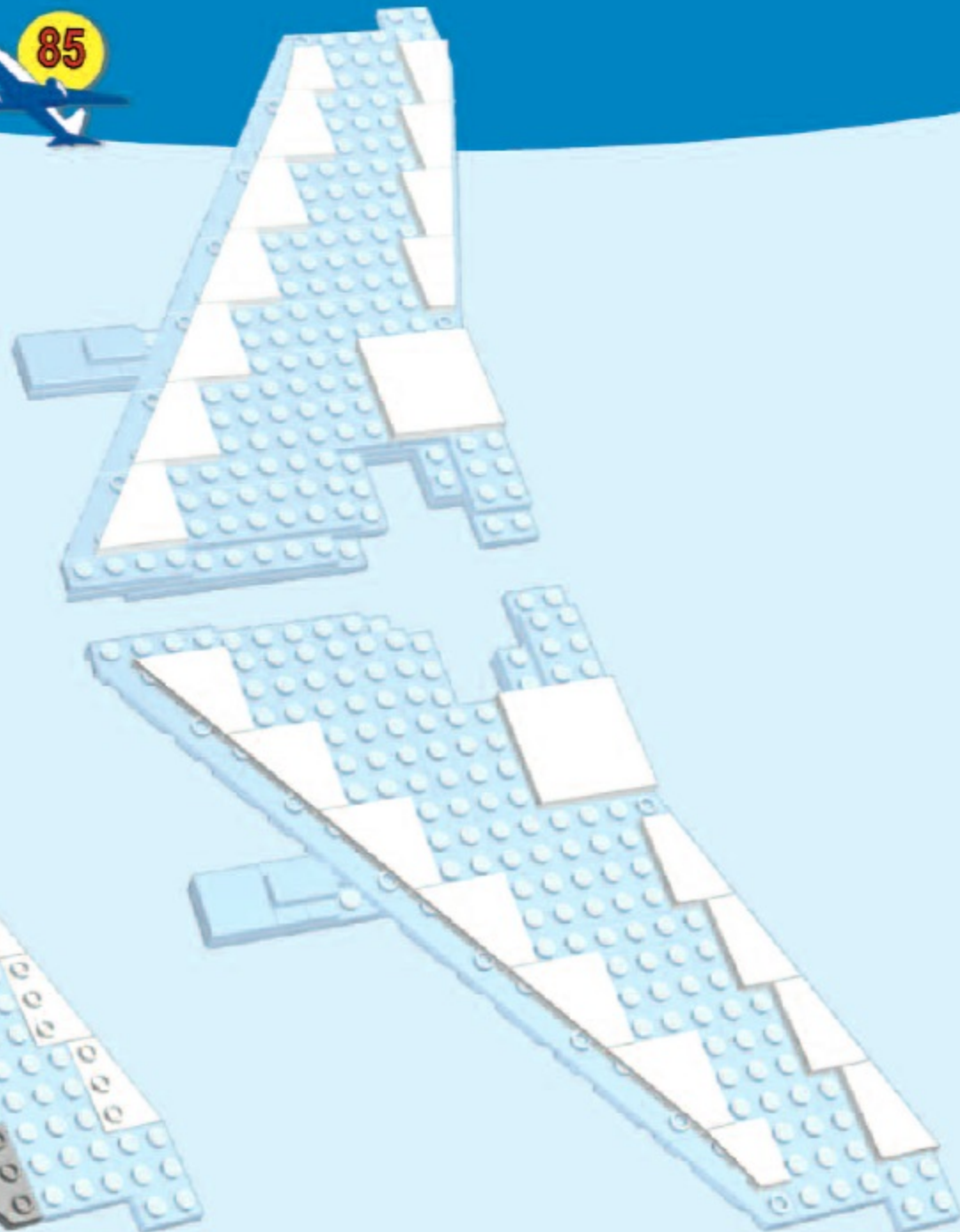



86



87



88

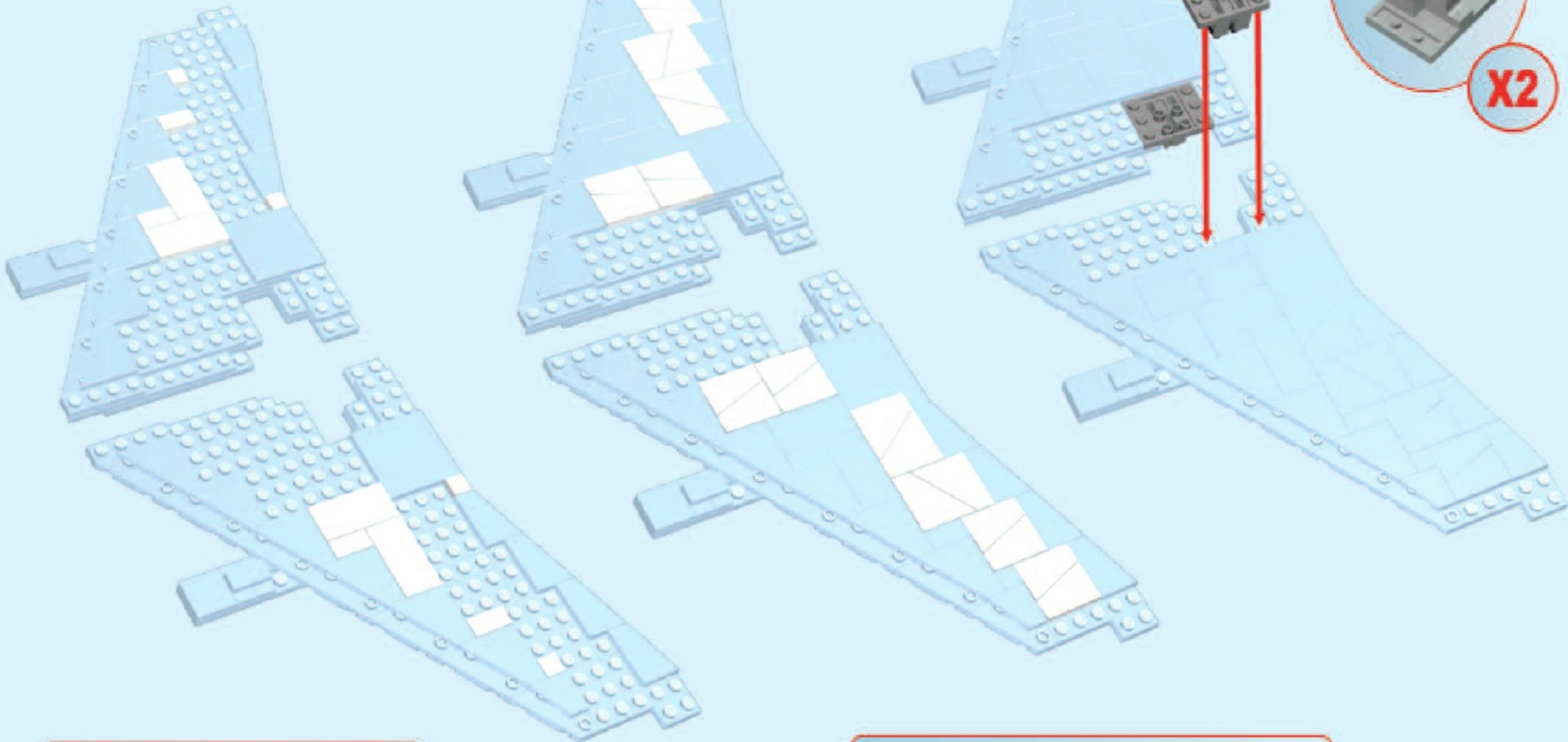

X2



X4

X4

X4



X8

X8

X4

X4

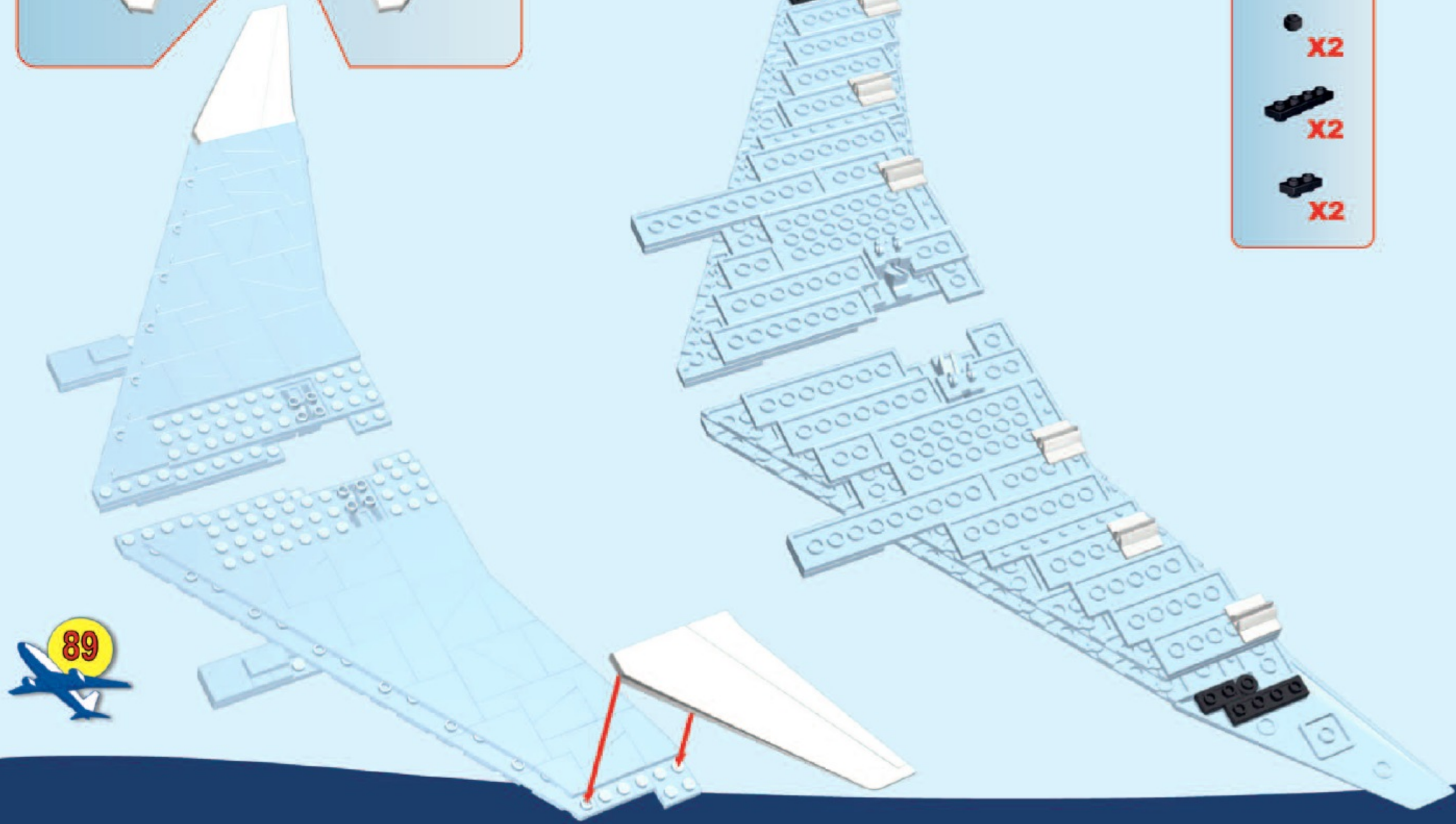
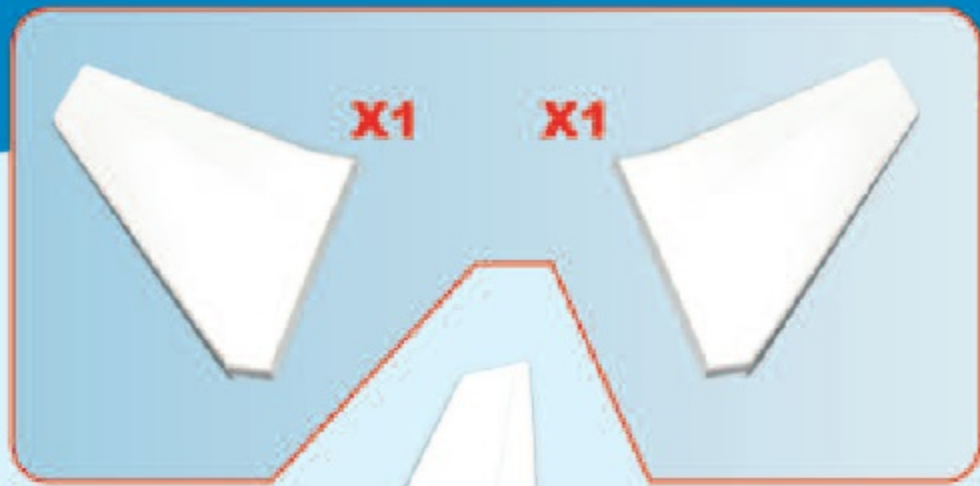

- X6
- X2
- X2
- X2

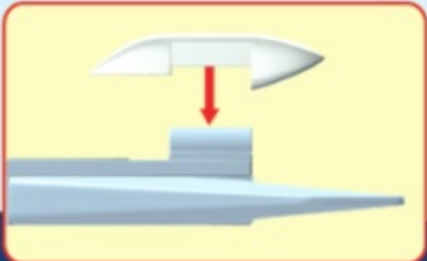
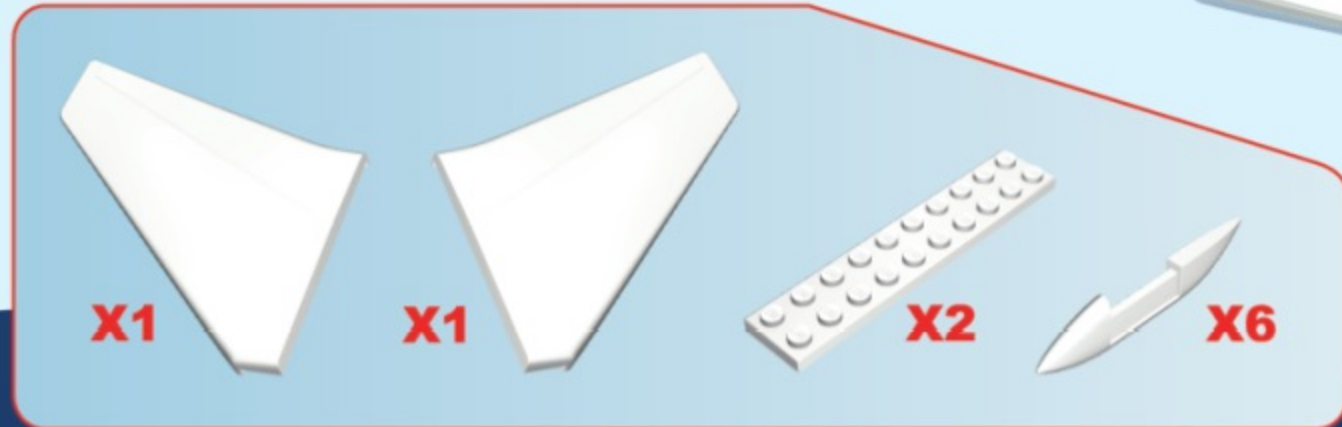

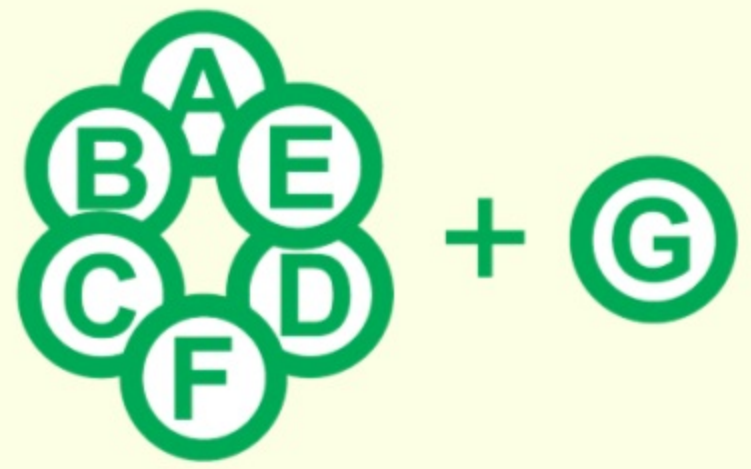



X2



X4



X2



X2

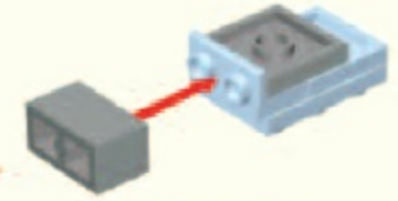
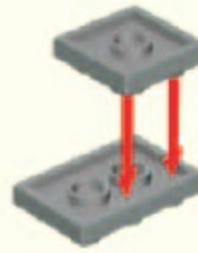

X2

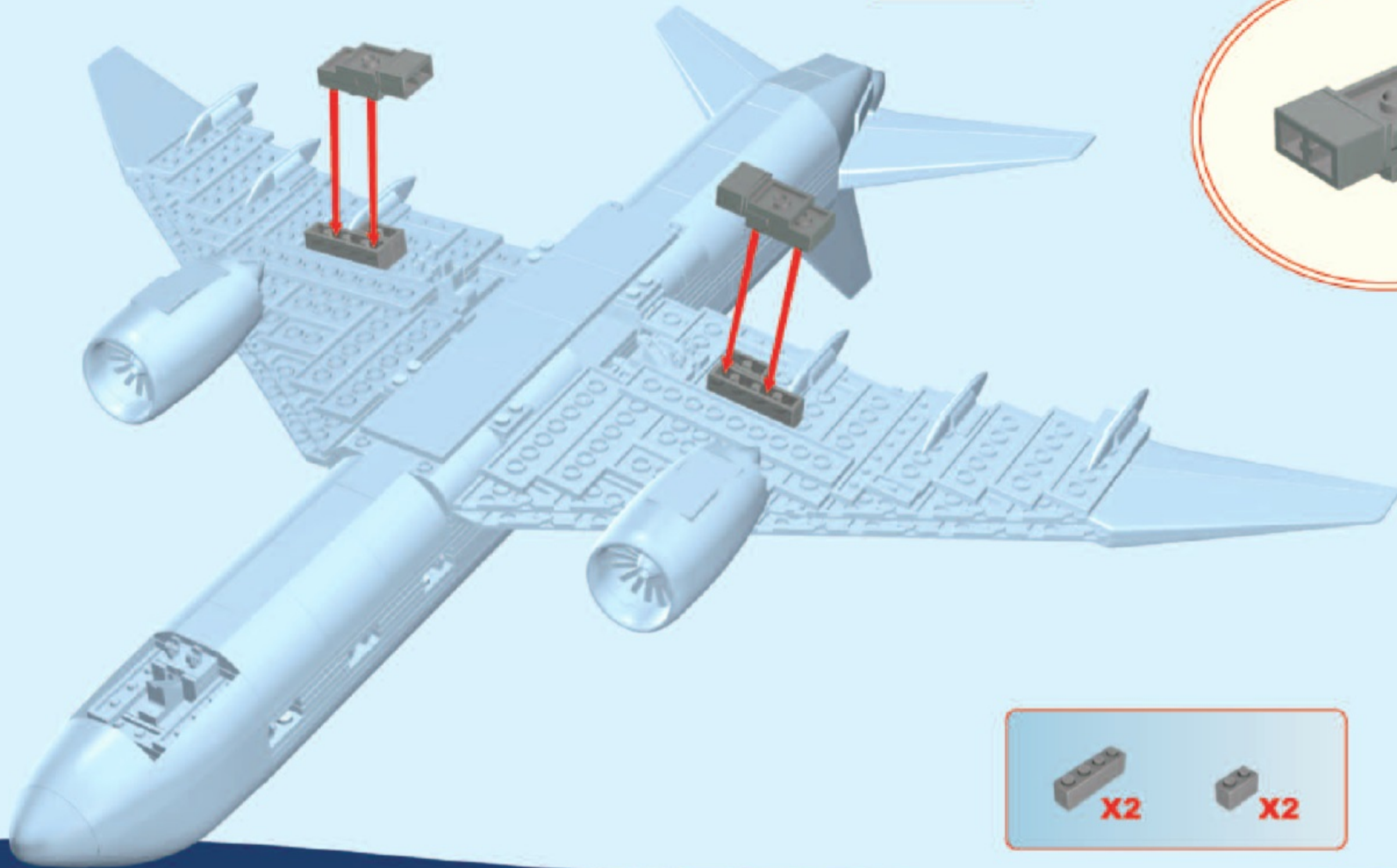

X2



X2

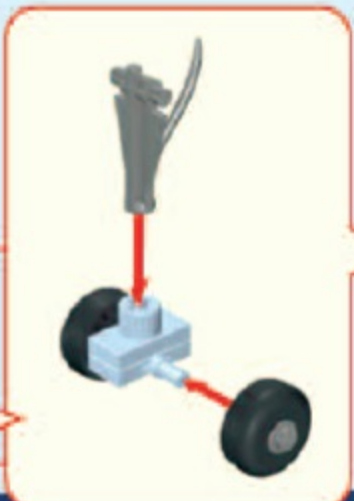
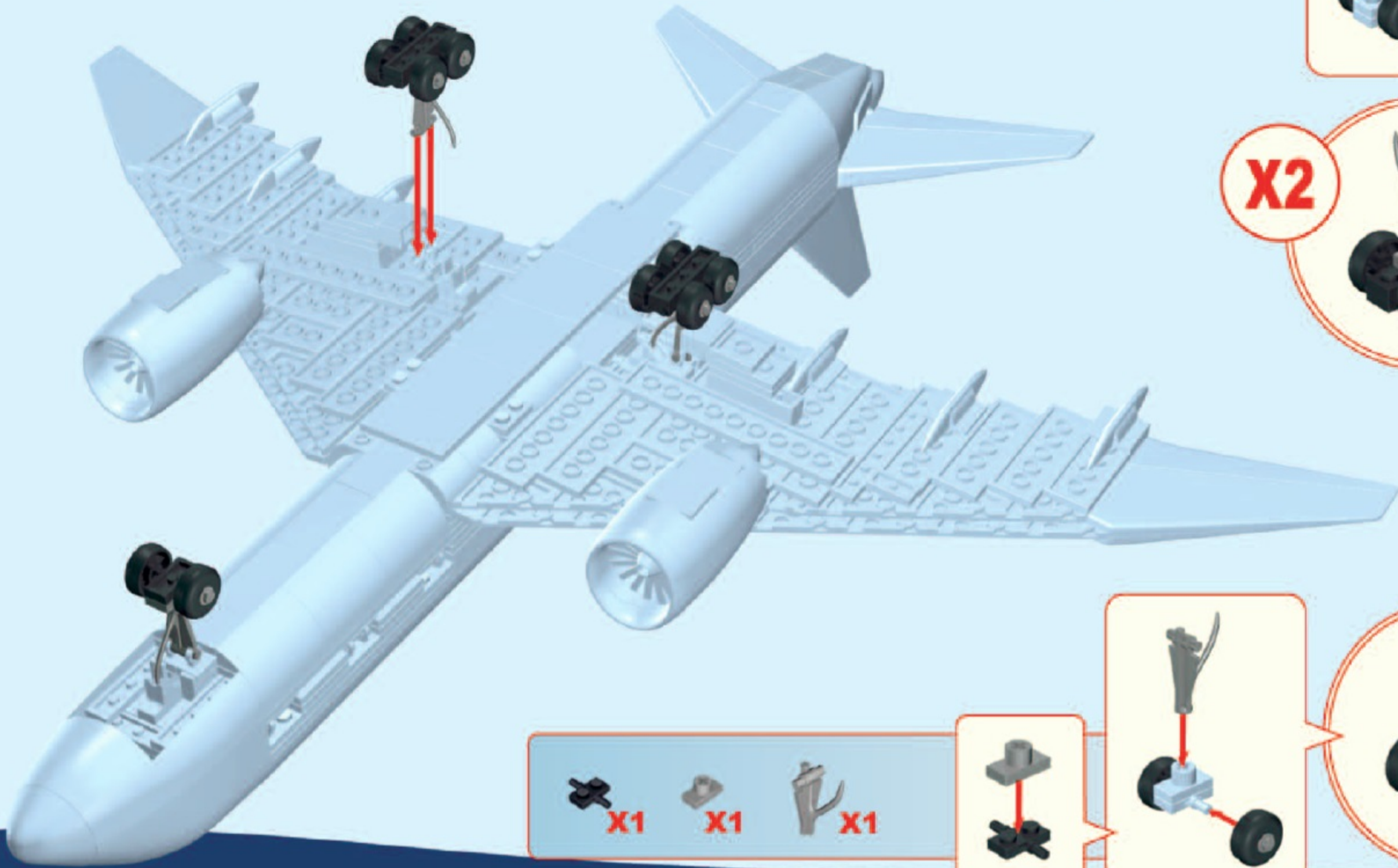
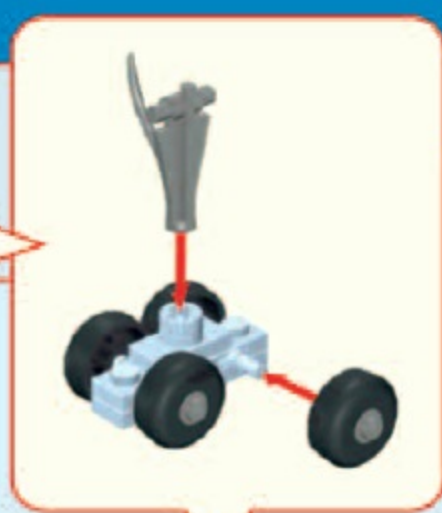
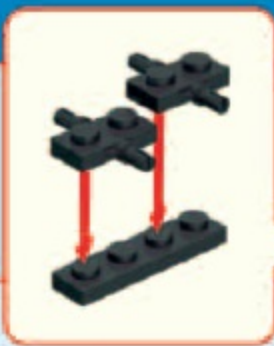

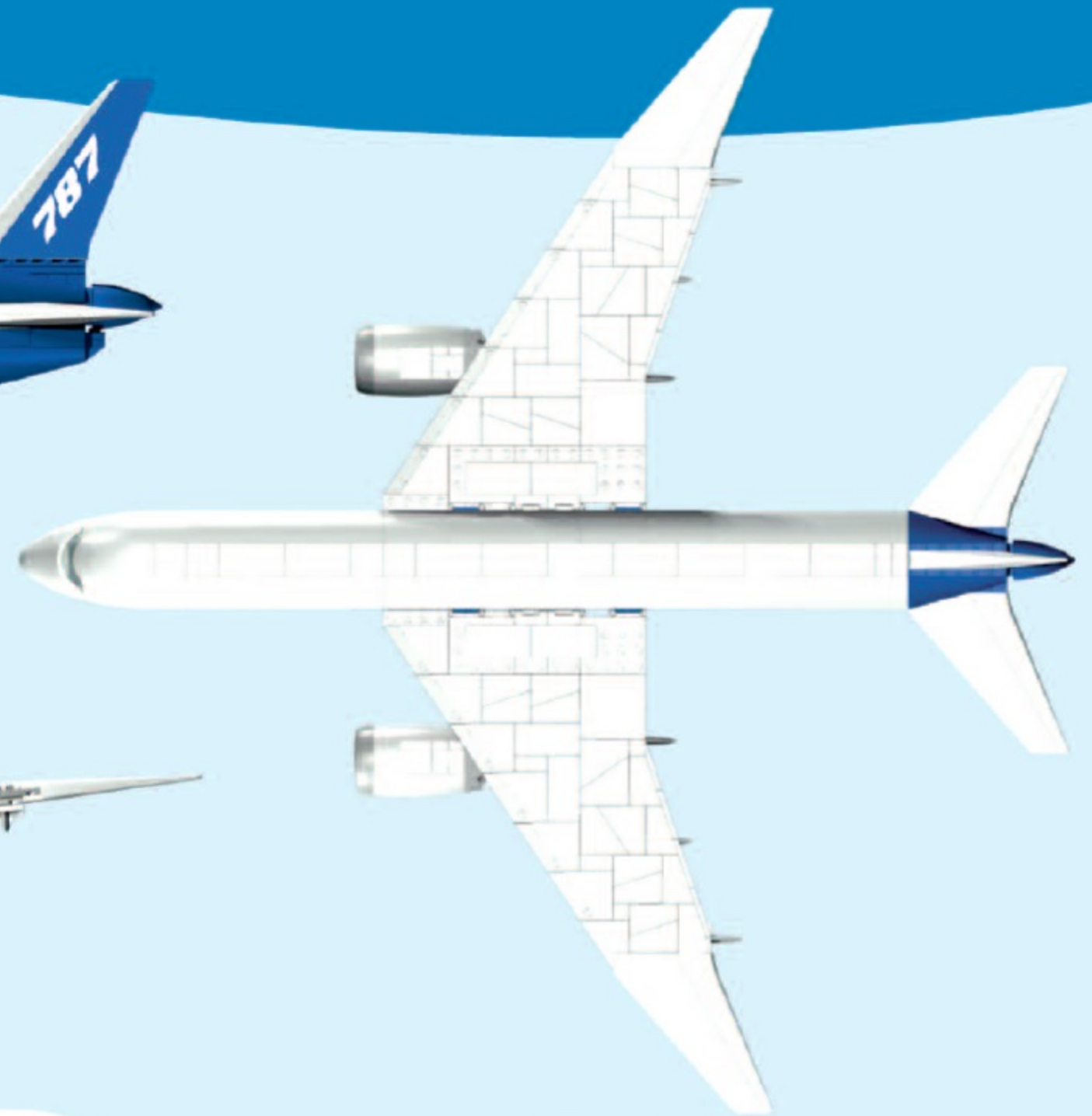

BOEING™



10-26700 N-675

 www.cobi.eu 