

DREAMWORKS
The PENGUINS
of **MADAGASCAR**
nickelodeon



Printed in EU



WARNING: CHOKING HAZARD-
Toy contains small parts.
Not for children under 3 years.

1

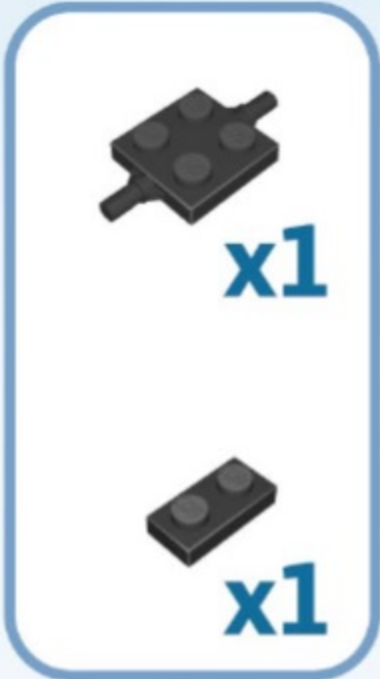
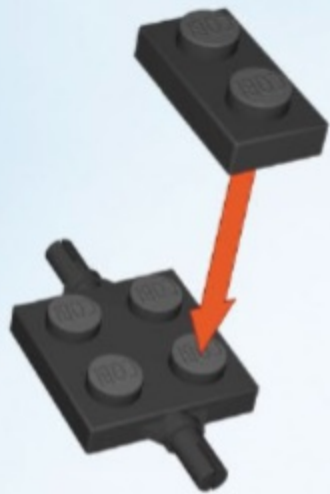

2

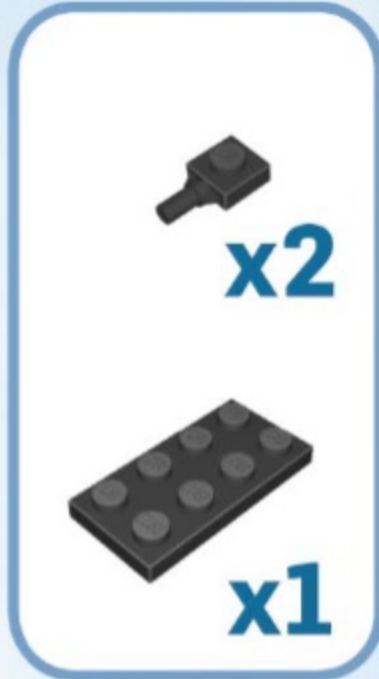
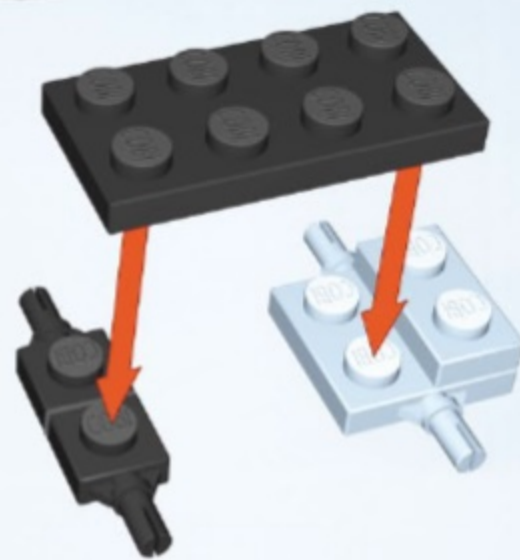

3

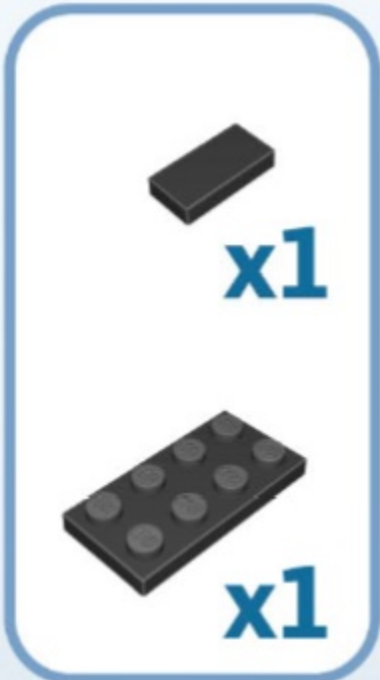
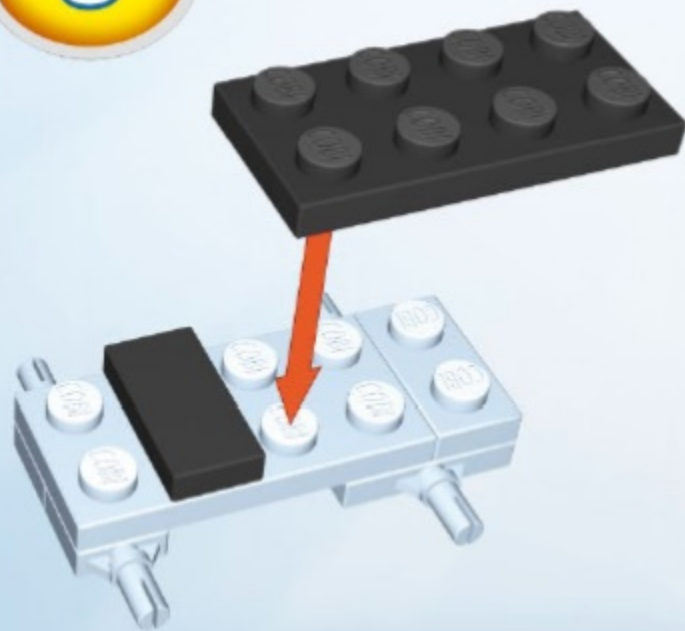

4

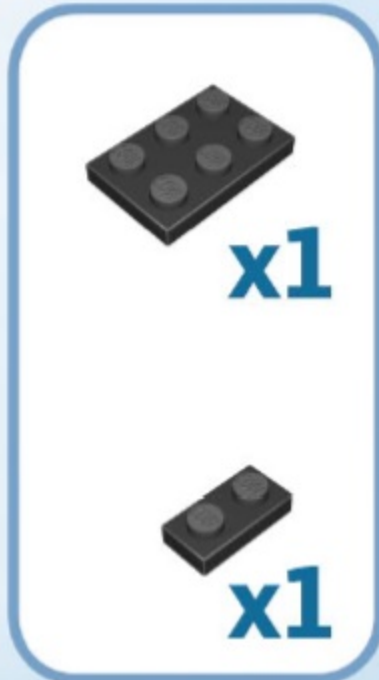
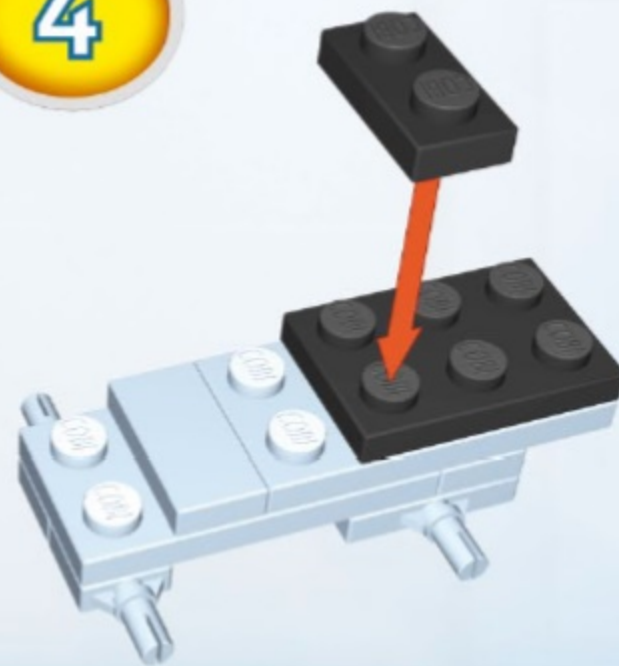

5

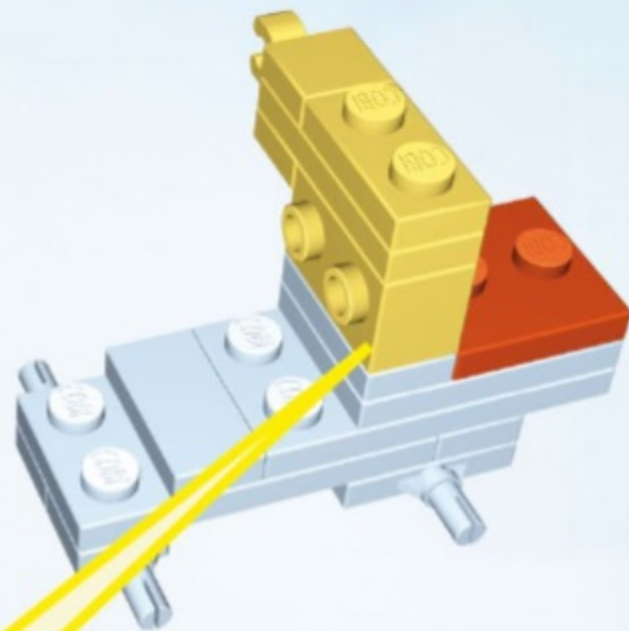
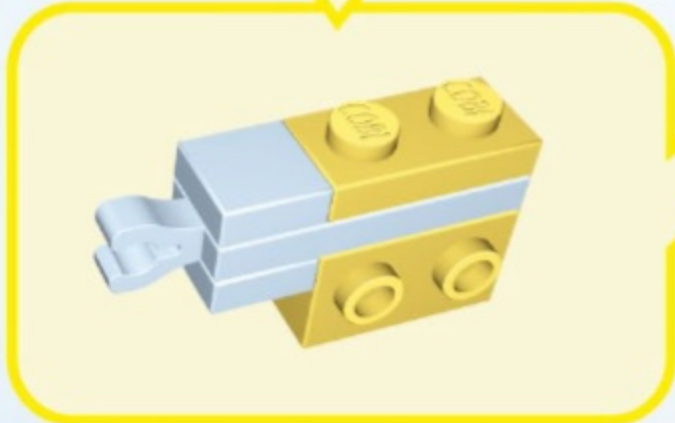
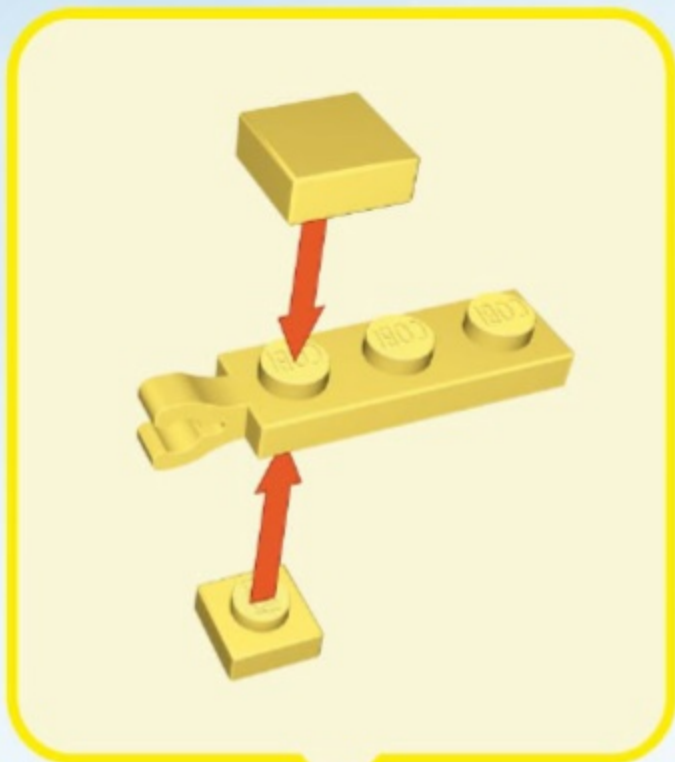

x1



x1



x1



x1



x1



x1

6

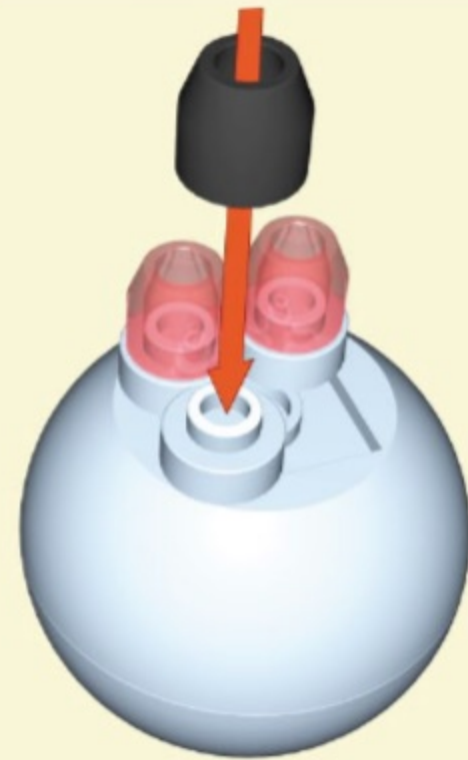
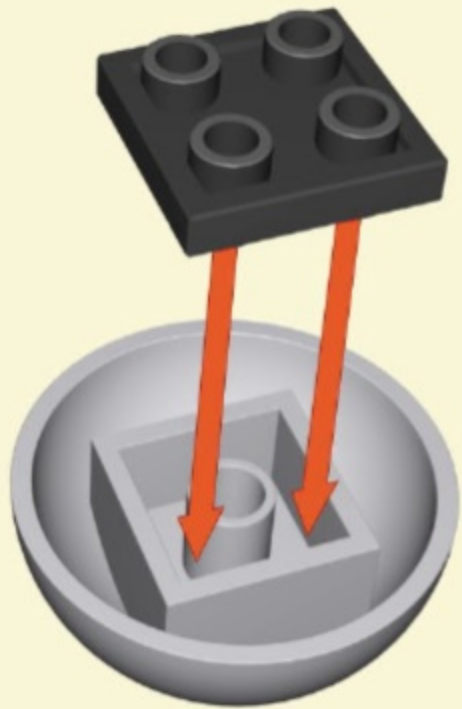

x2



x1



x2



x1



x2



x1

7

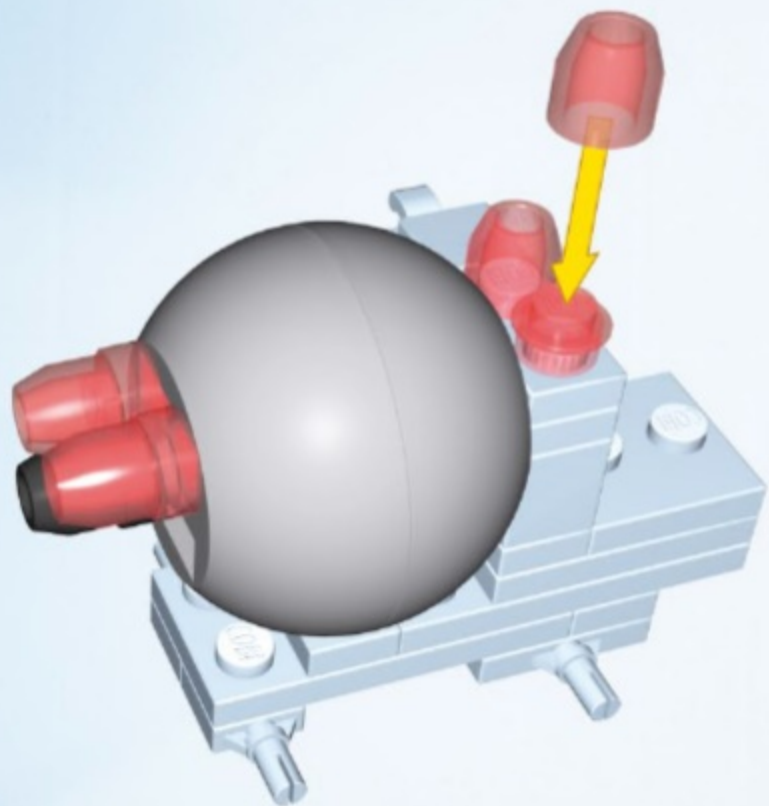

x1

x2

8

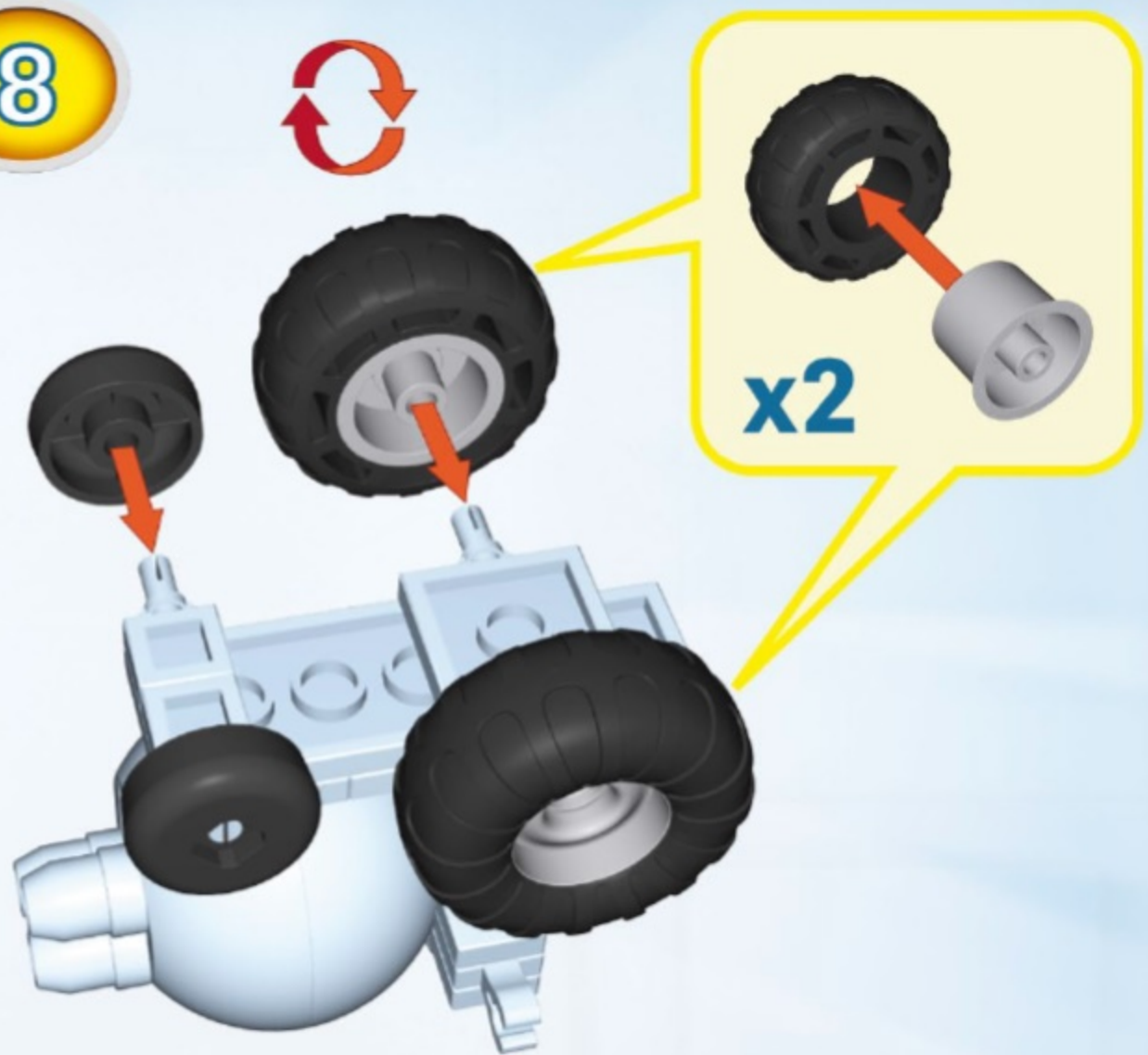

x2

x2

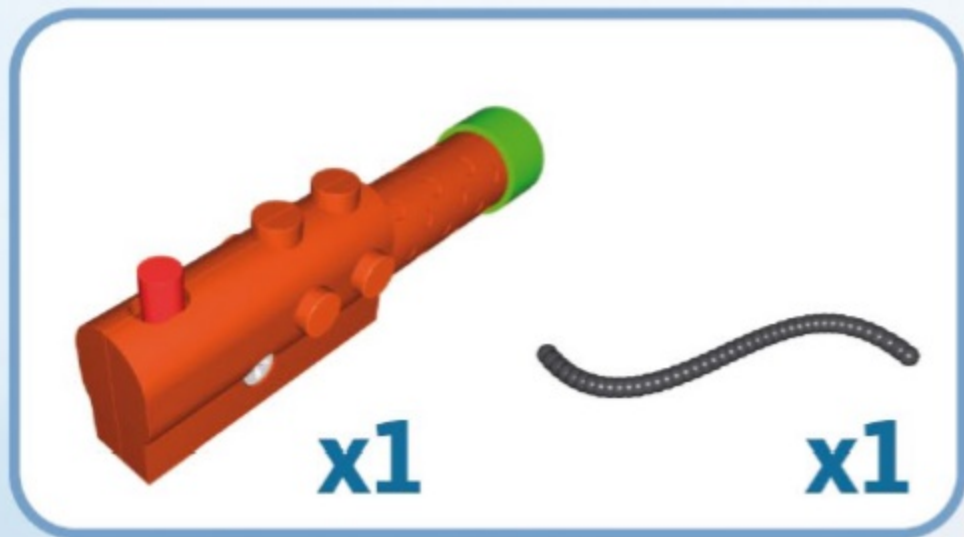
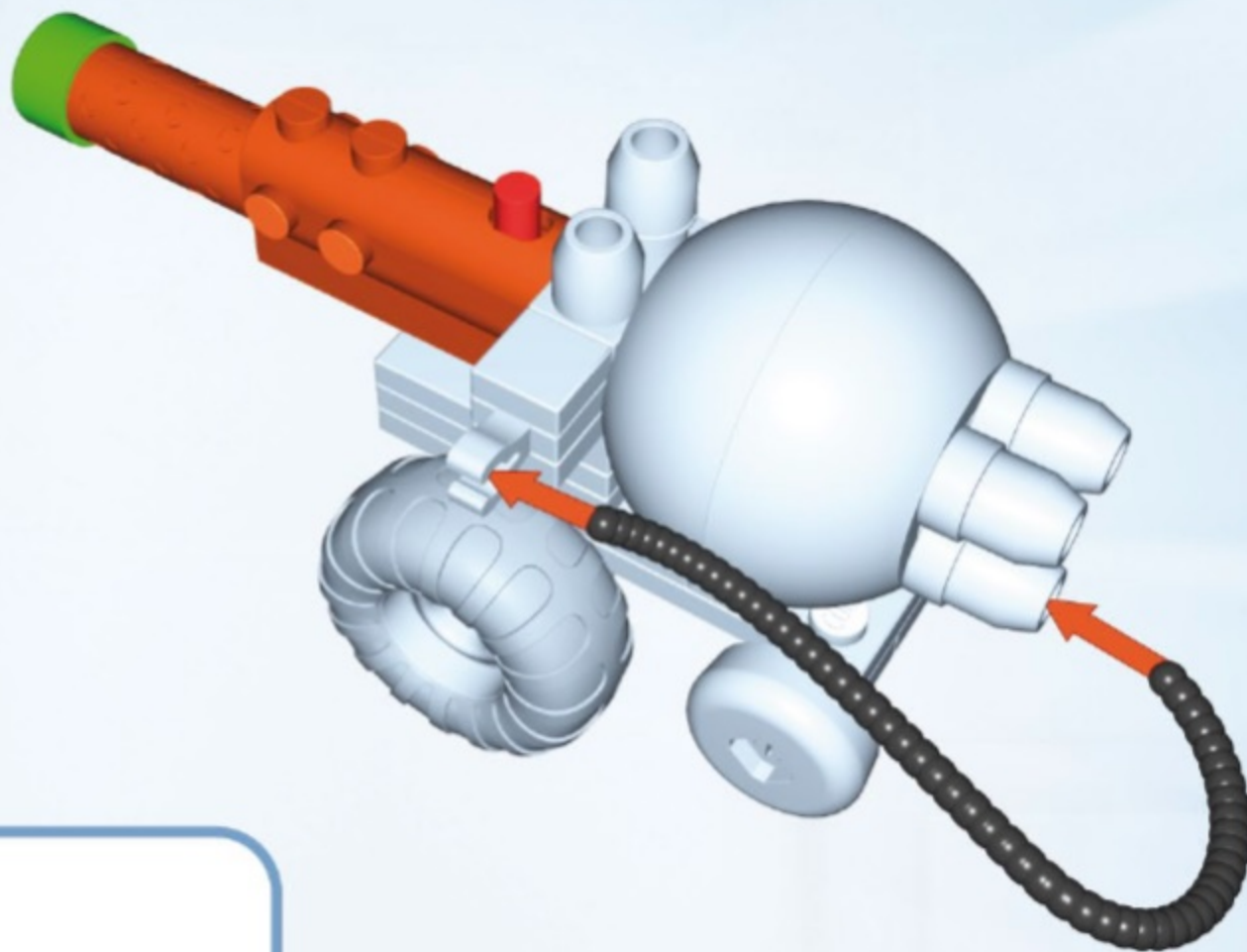

x2

9

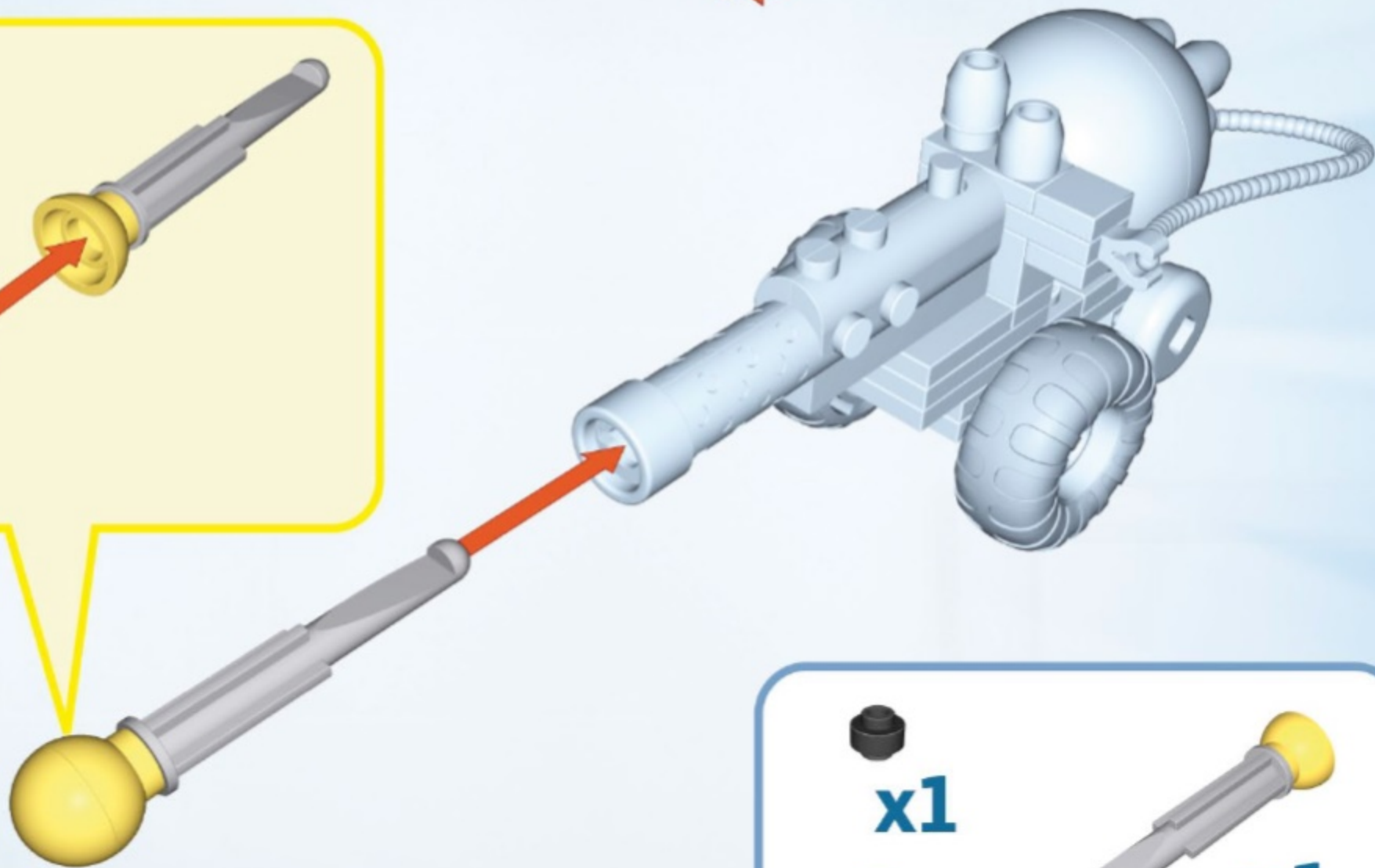
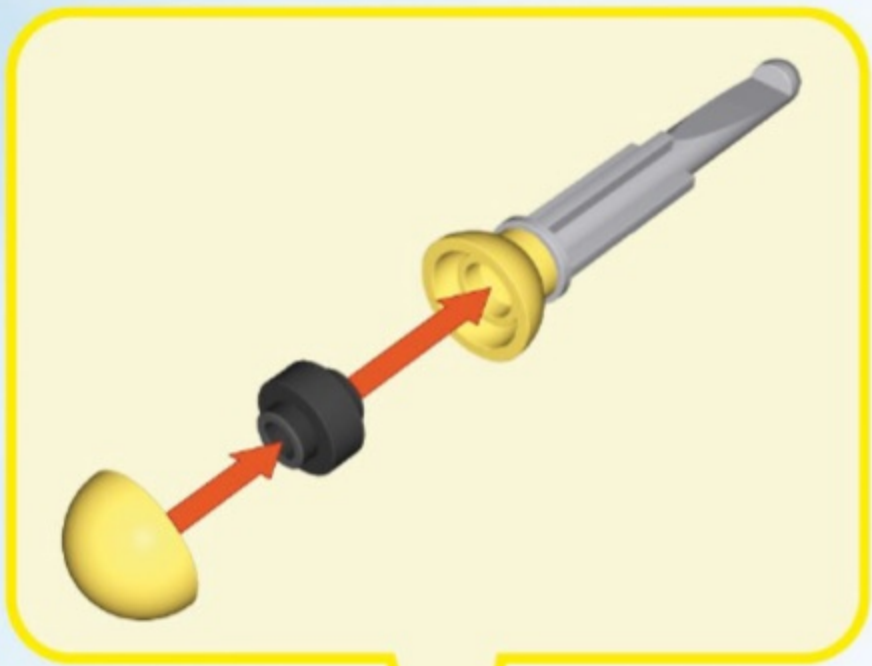

10



-  x1
-  x1
-  x1

Bi-Plane Bomber



26150



26400

King Julien's ZOO Adventure



26080

Golf Cart Madness



26230

Swing & Smash Crane



26280

The S.T.A.N.K. Mobile

00-26050-38

