



WILLYS MB
with HELICOPTER

Jeep®

Jeep, the Jeep grille and related logos, vehicle model names and trade dress are trademarks of Chrysler Group LLC and used under license by Cobi.
©2014 Chrysler Group LLC.



WWW.COBI.EU



Printed in EU



WARNING: CHOKING HAZARD-
Toy contains small parts.
Not for children under 3 years.

BE CAREFUL: NOTICE THE DIFFERENCE



UWAGA: RÓŻNE KLOCKI

2

3

1

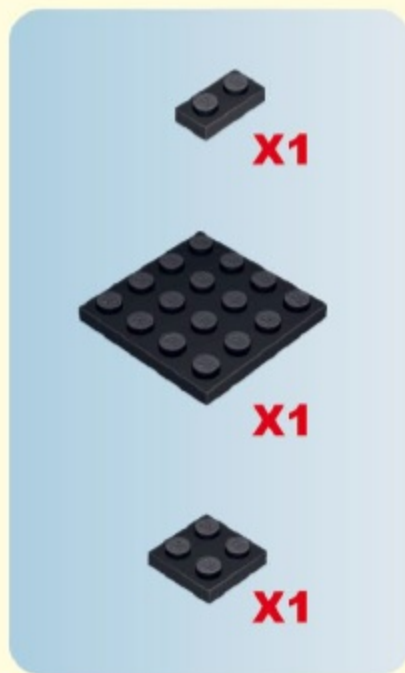
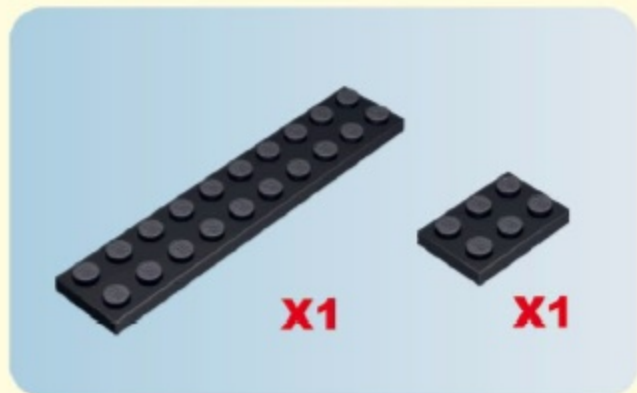
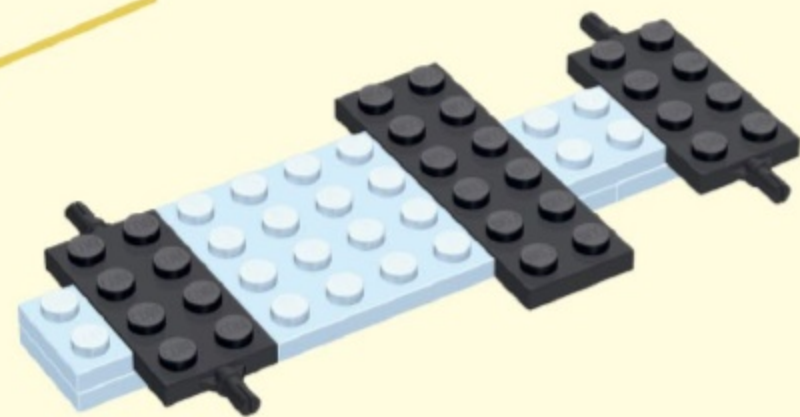
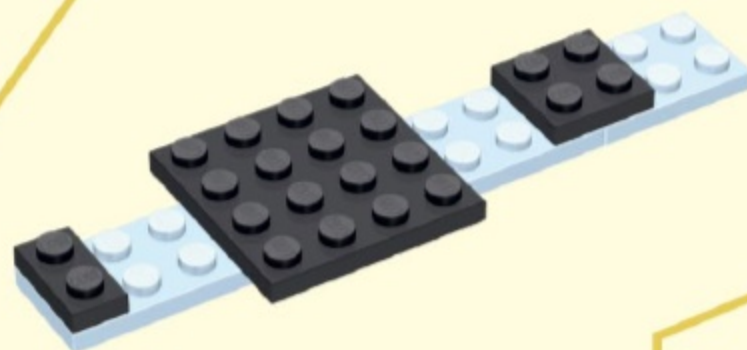
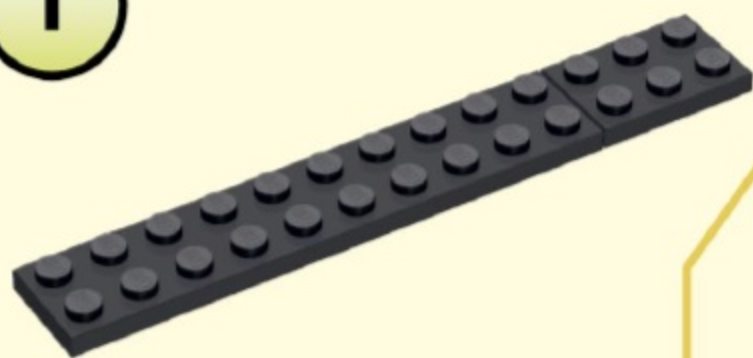

4

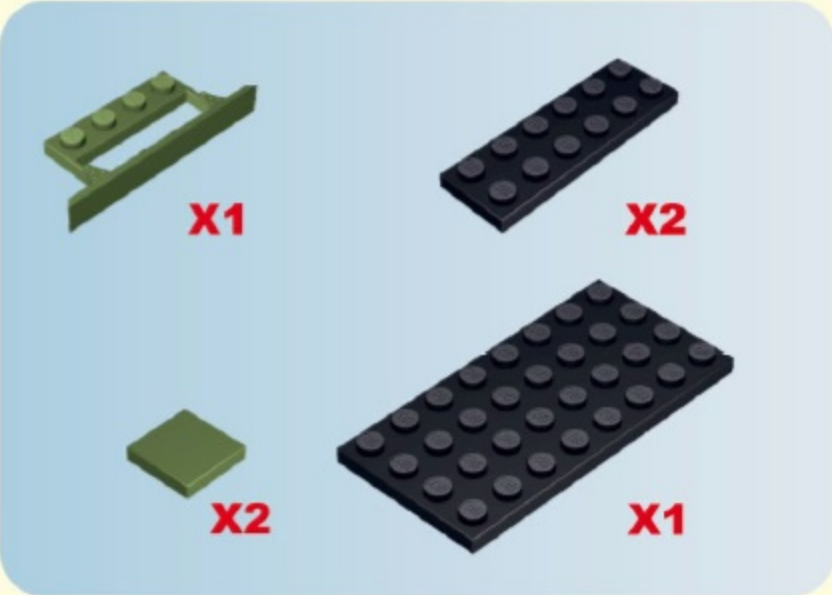
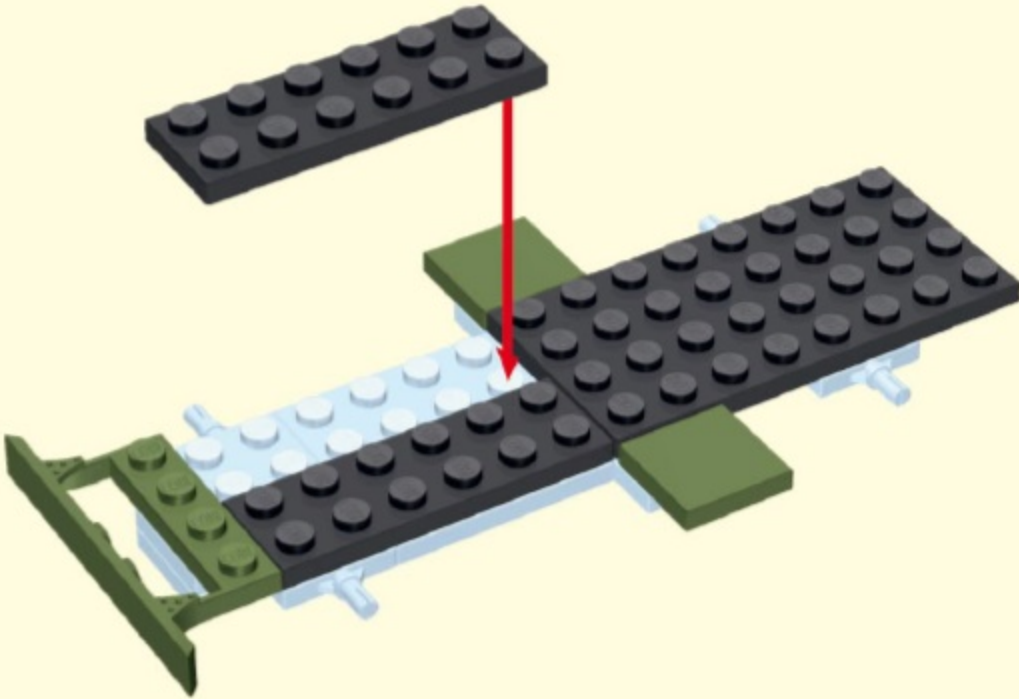

5

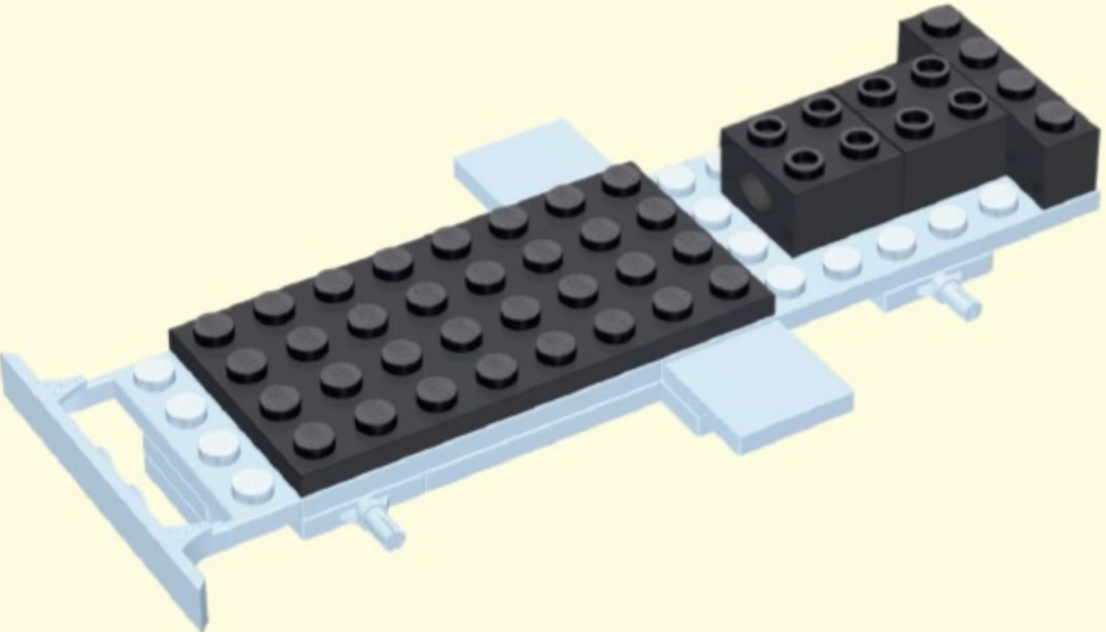

6

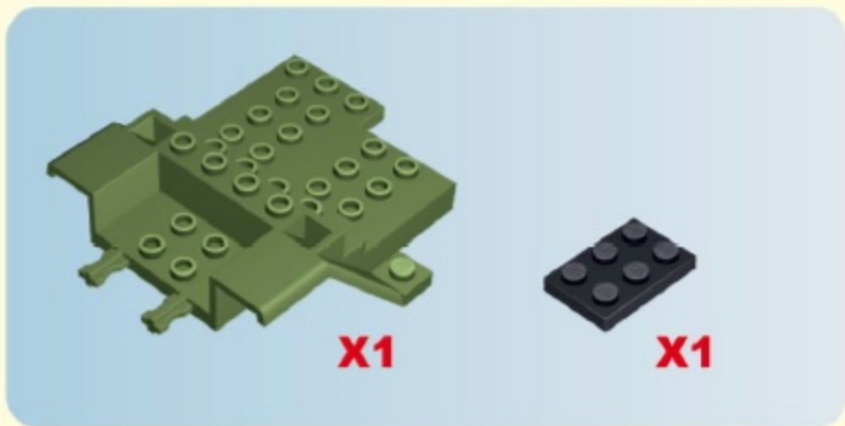
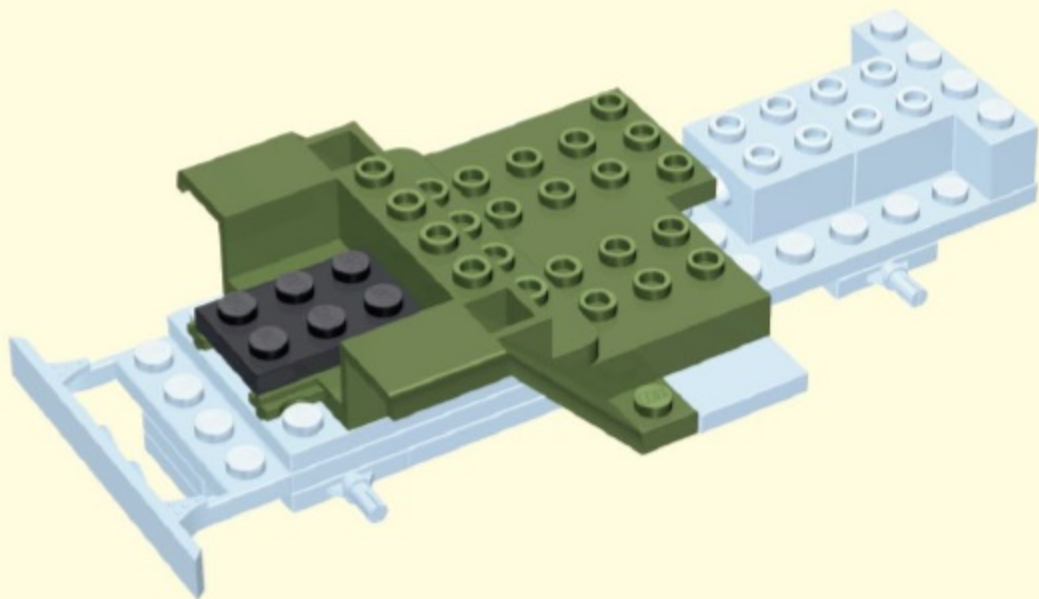

7

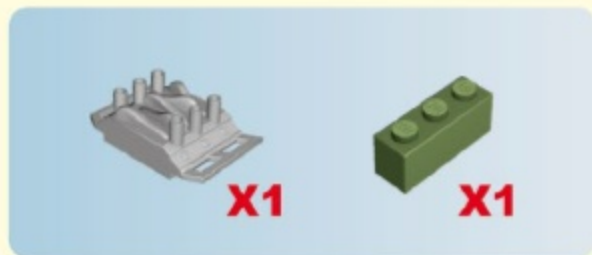
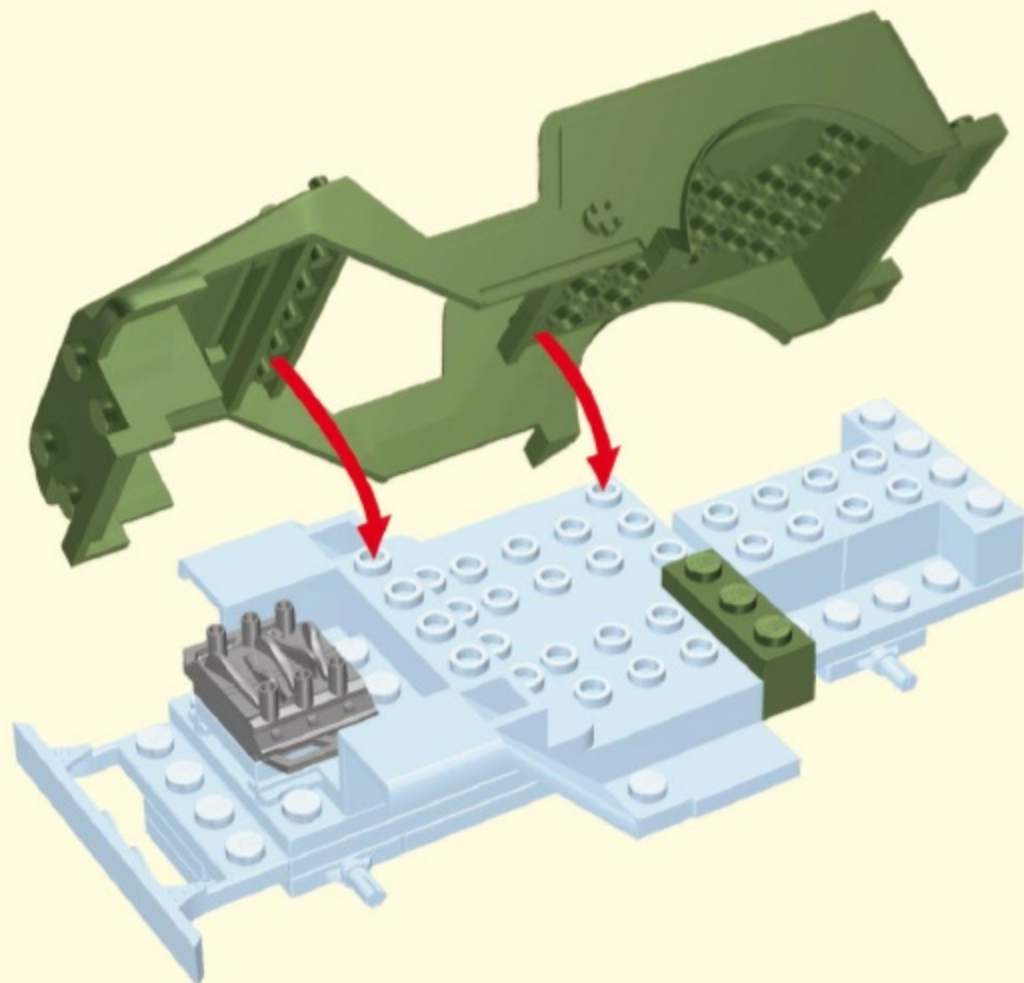

8

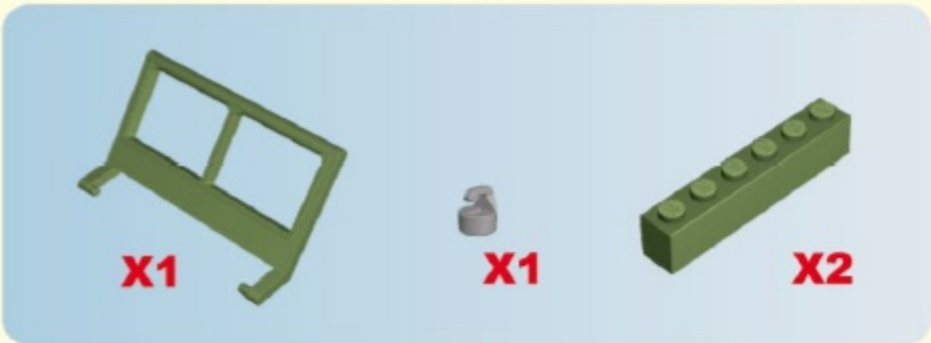
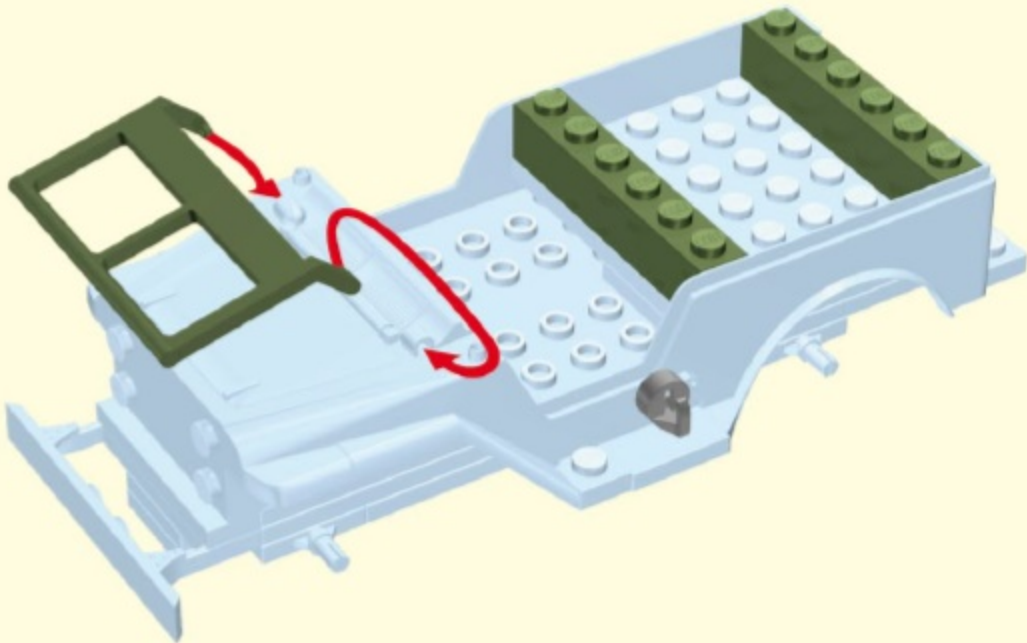

9

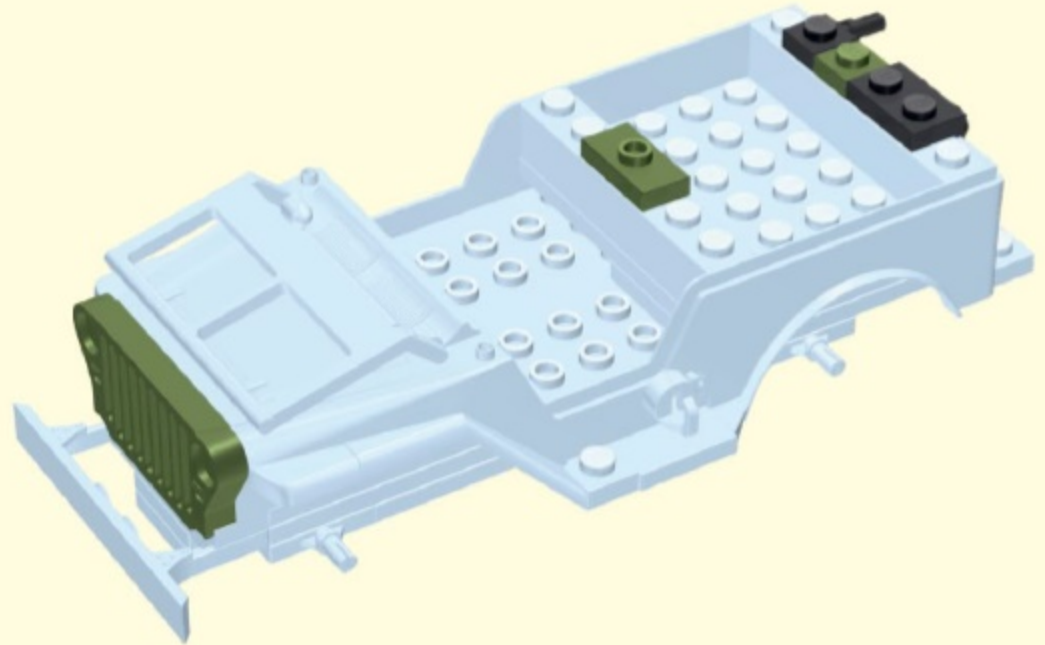

10

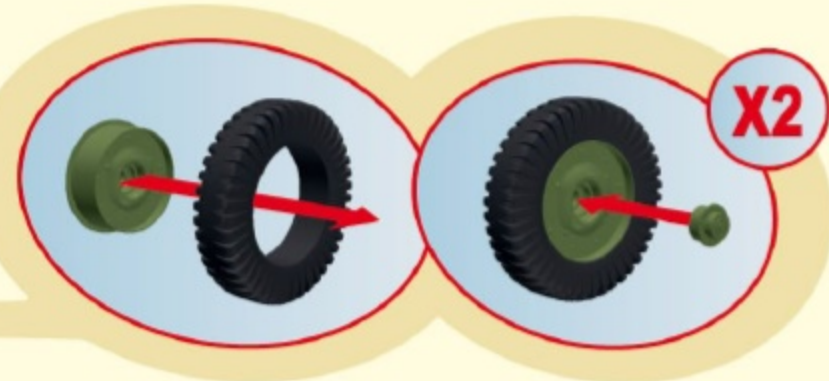

11

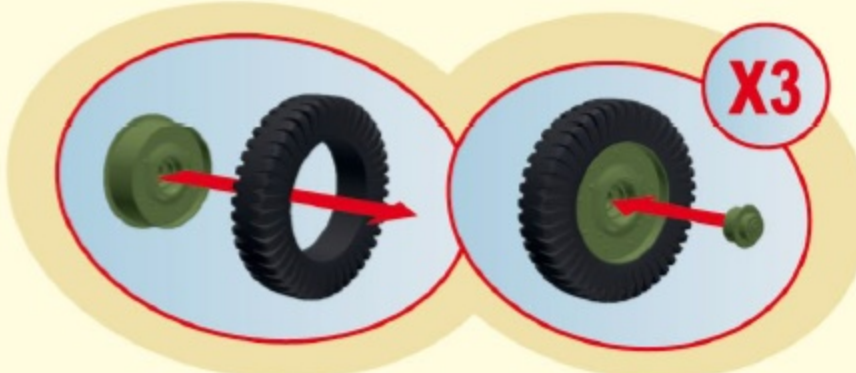

12

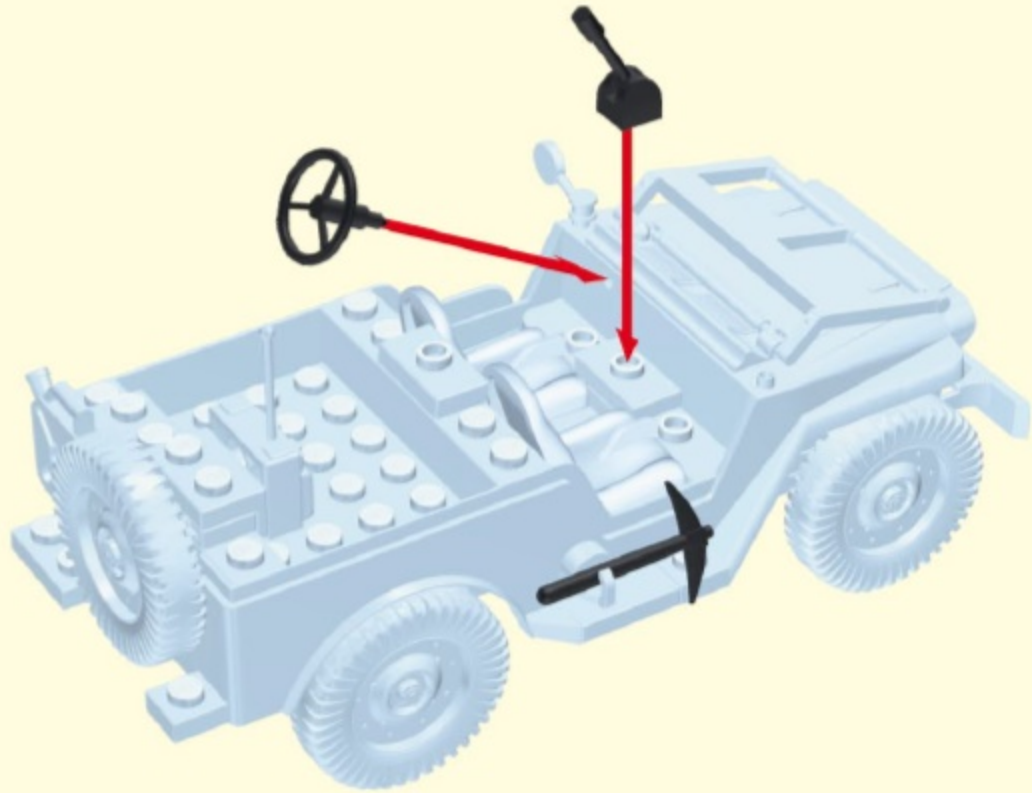

13



A

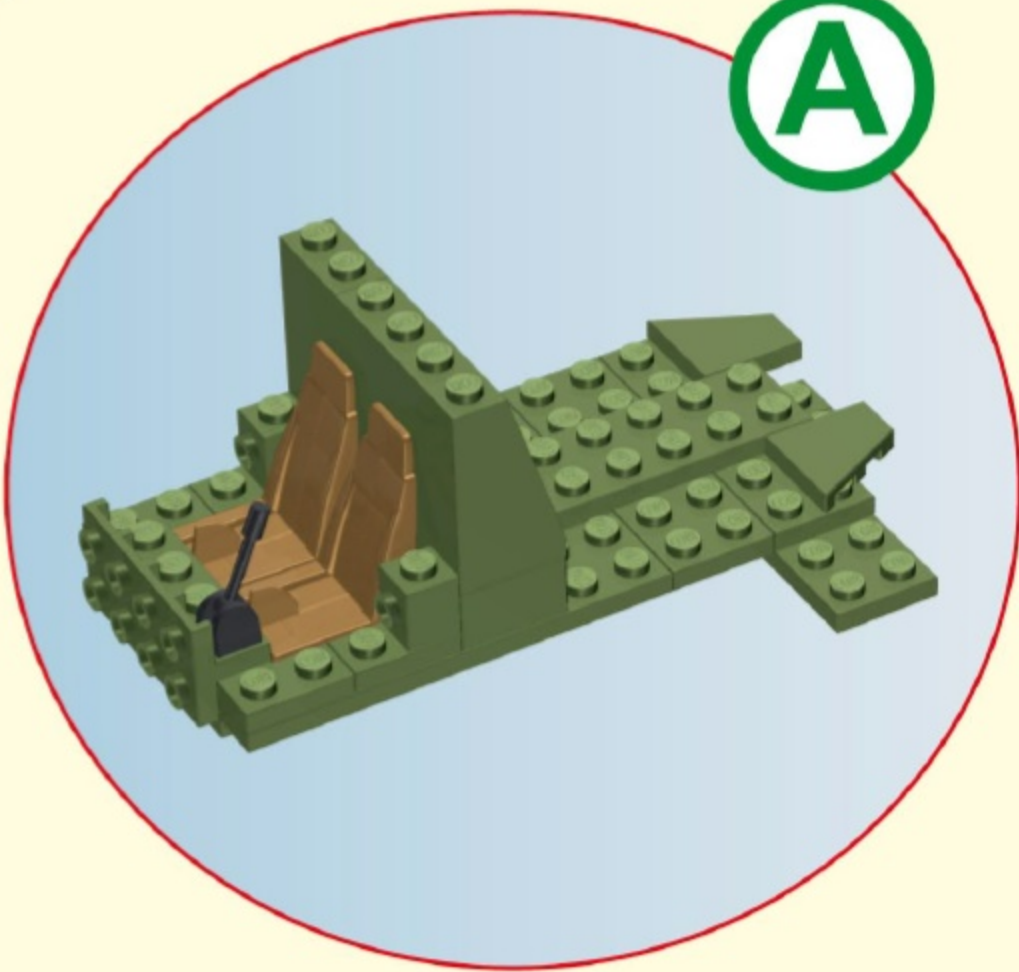

14

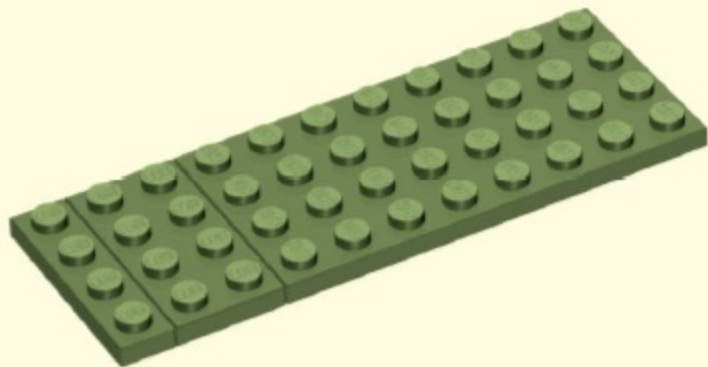

15

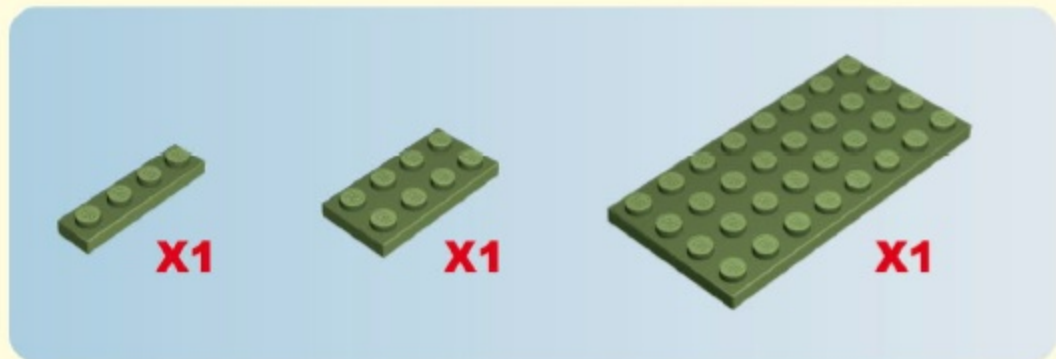
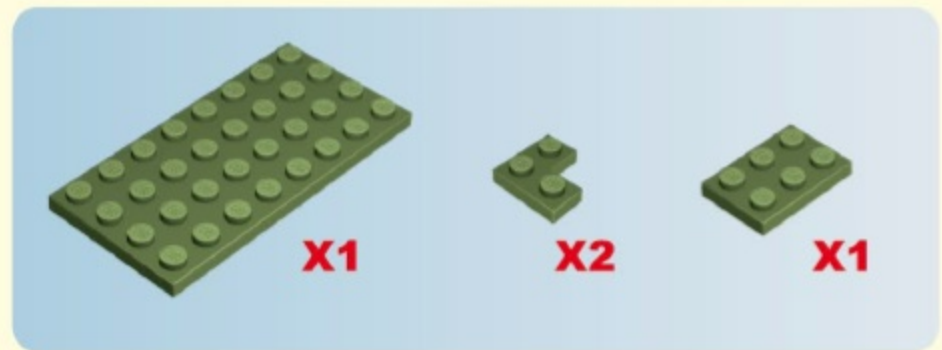
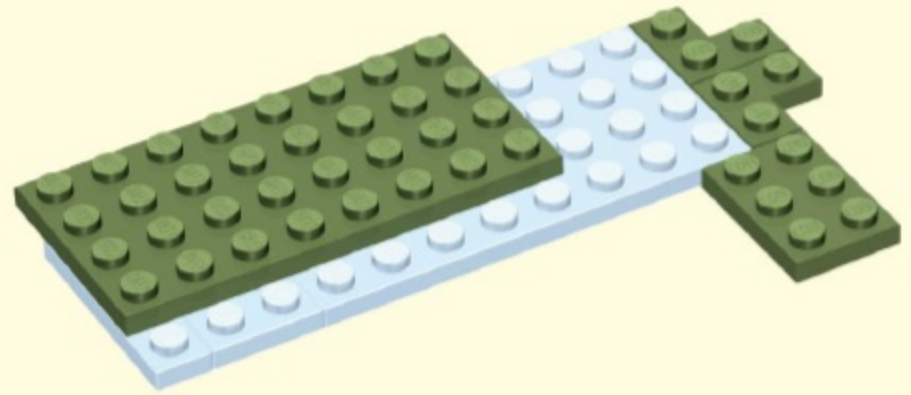

16

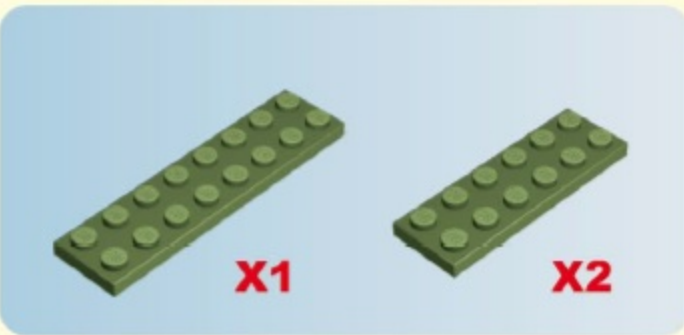
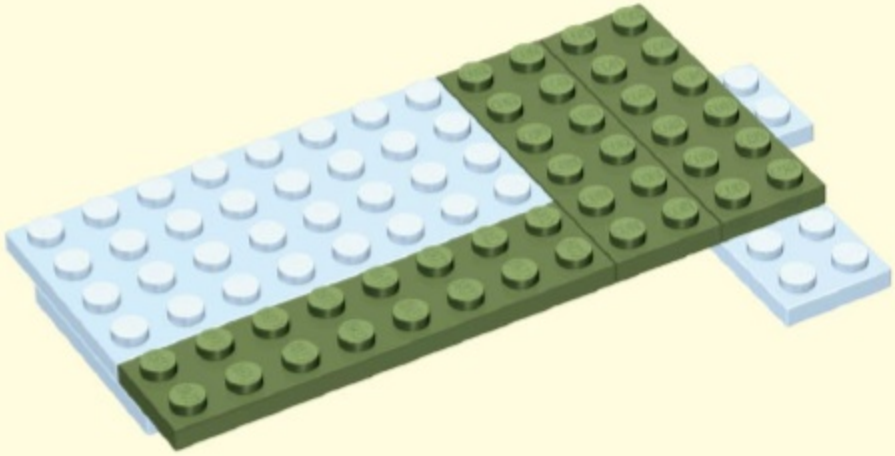

17

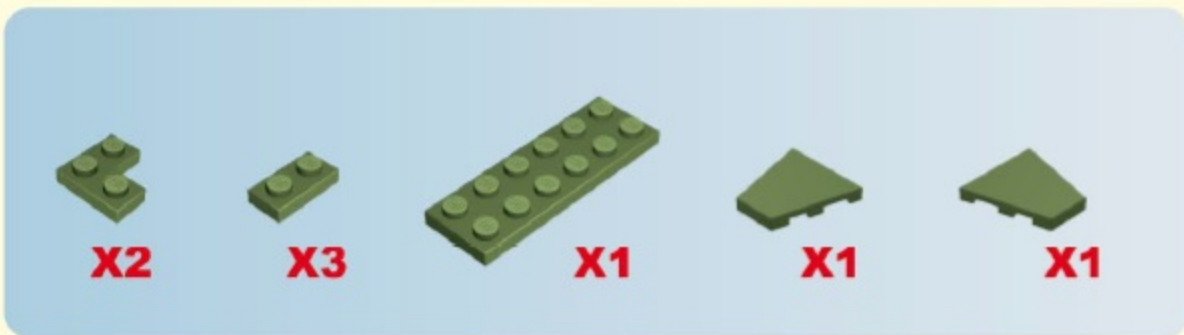
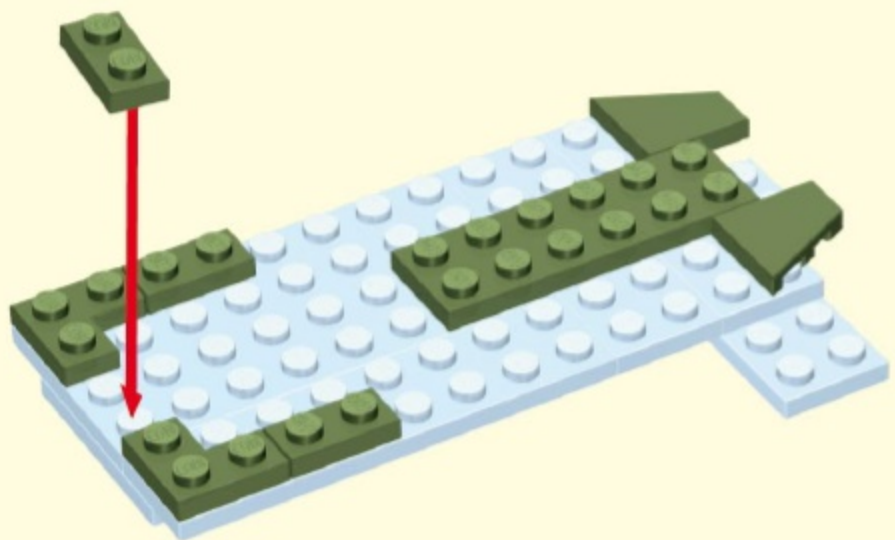

18

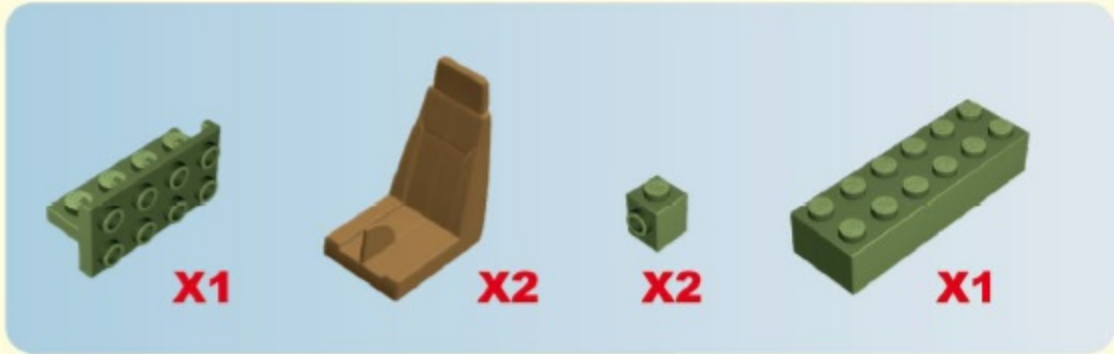
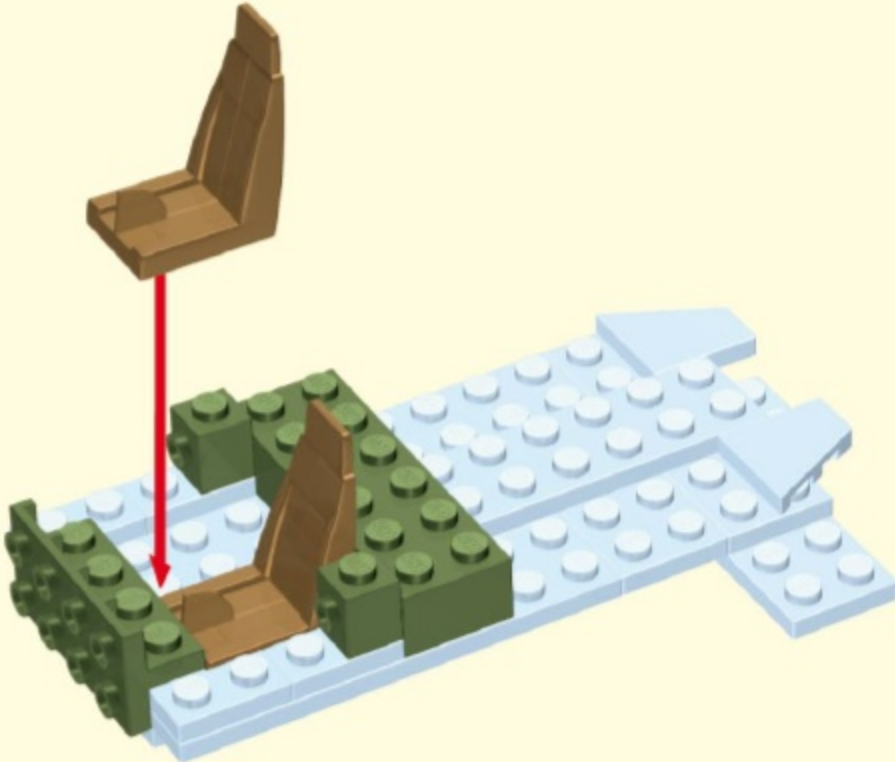

19

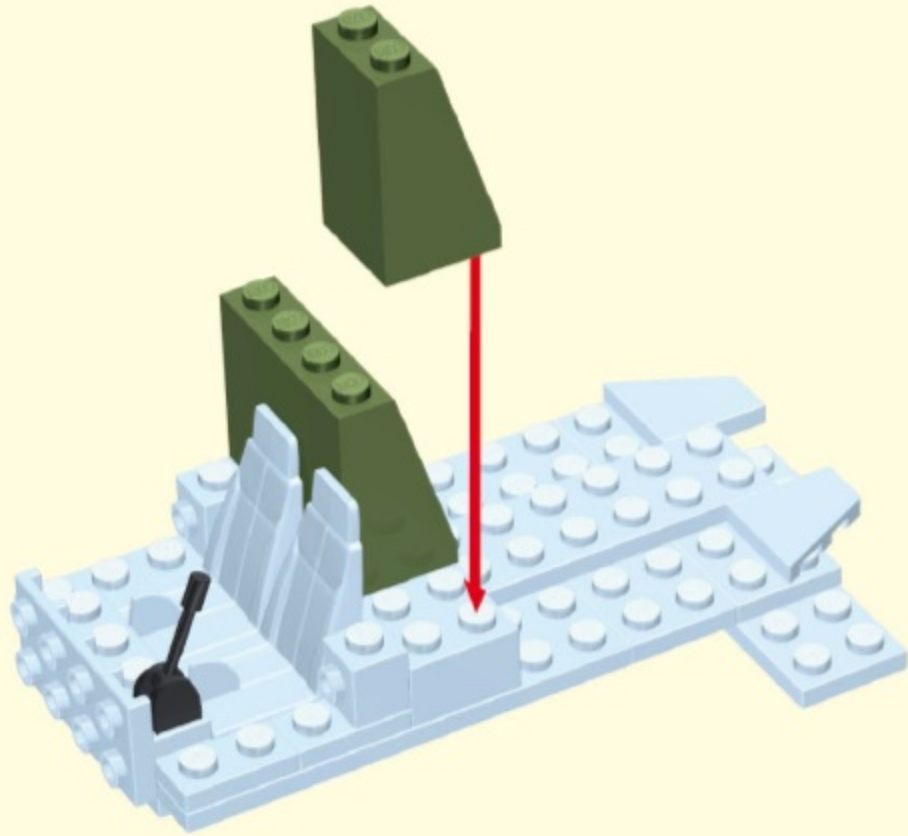

21

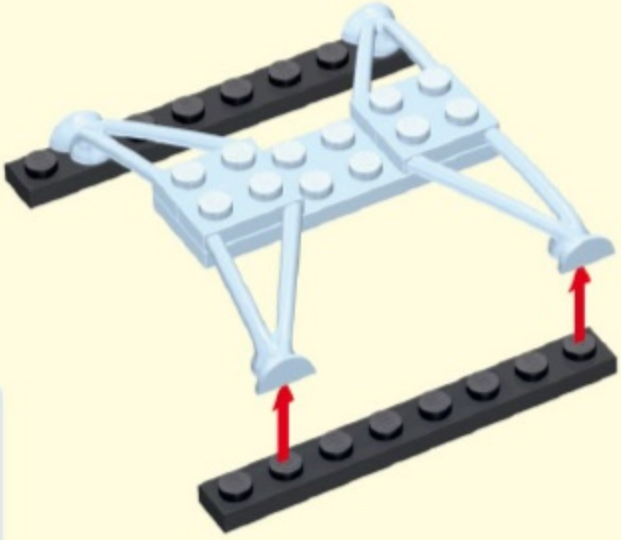

22

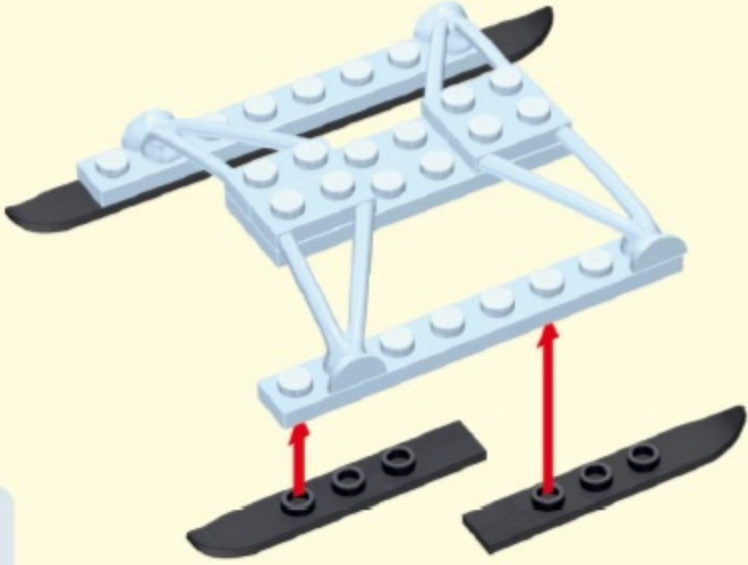

B

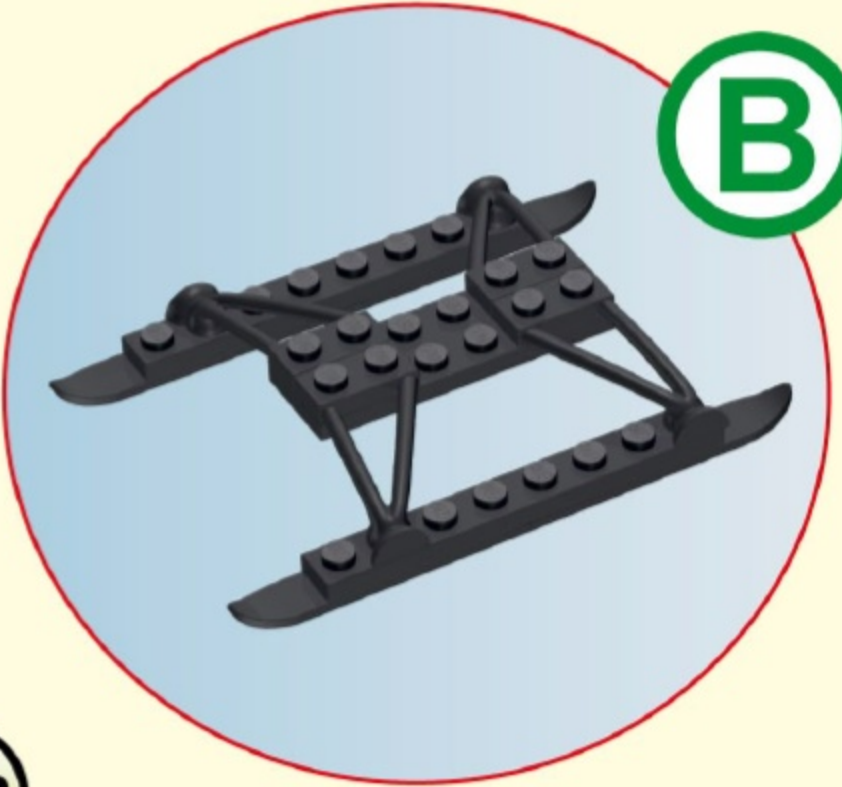

20

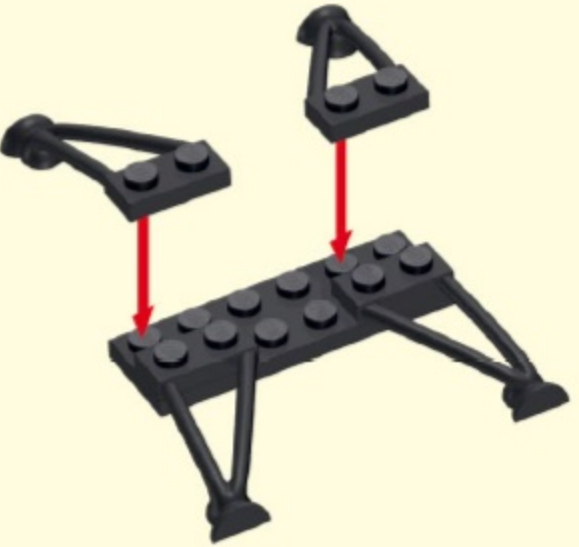

23

(A) + (B)

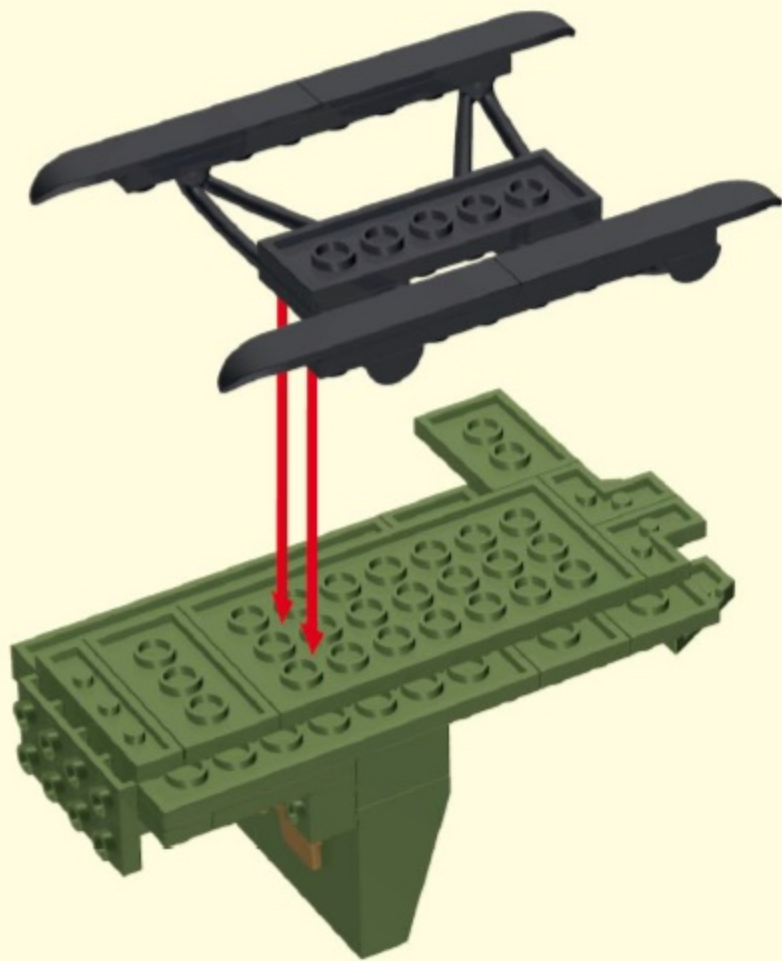

24

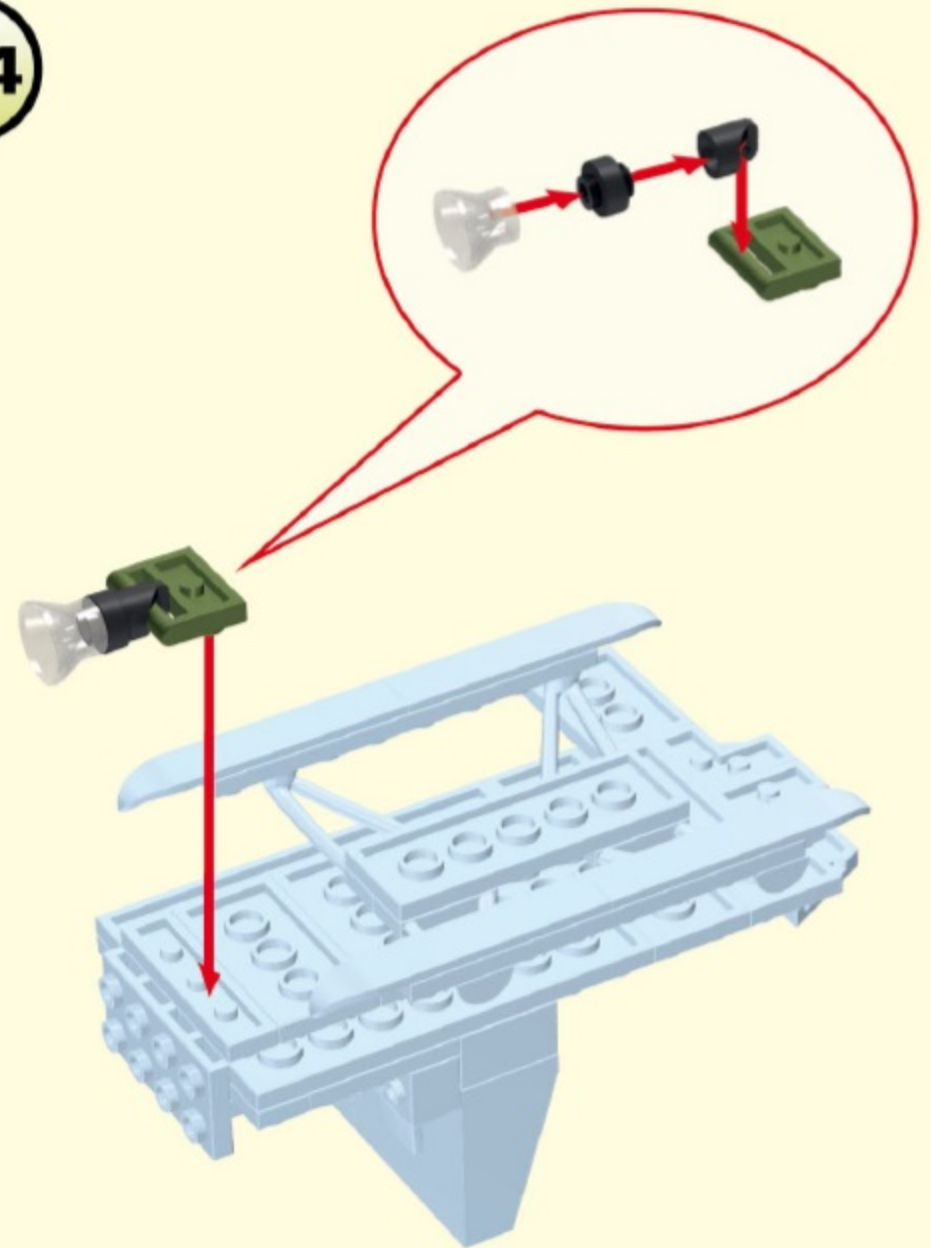

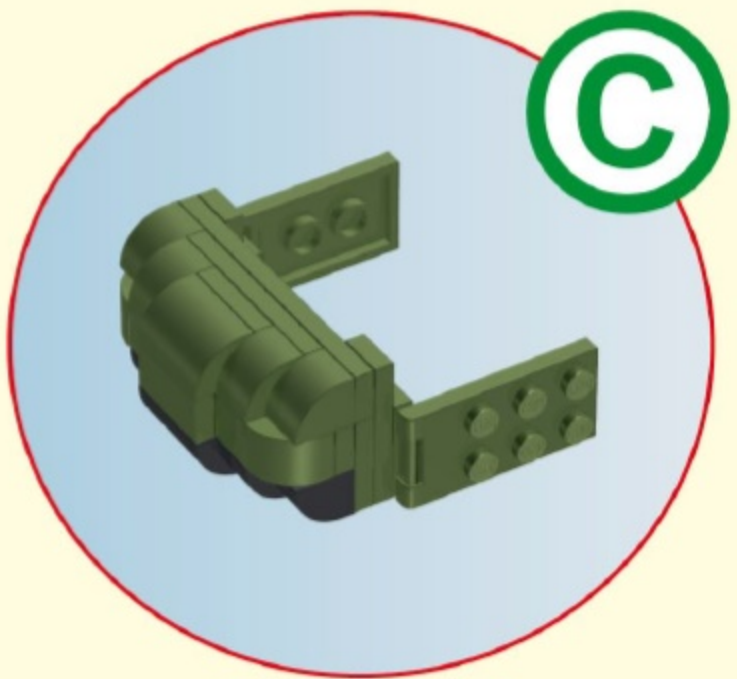

25

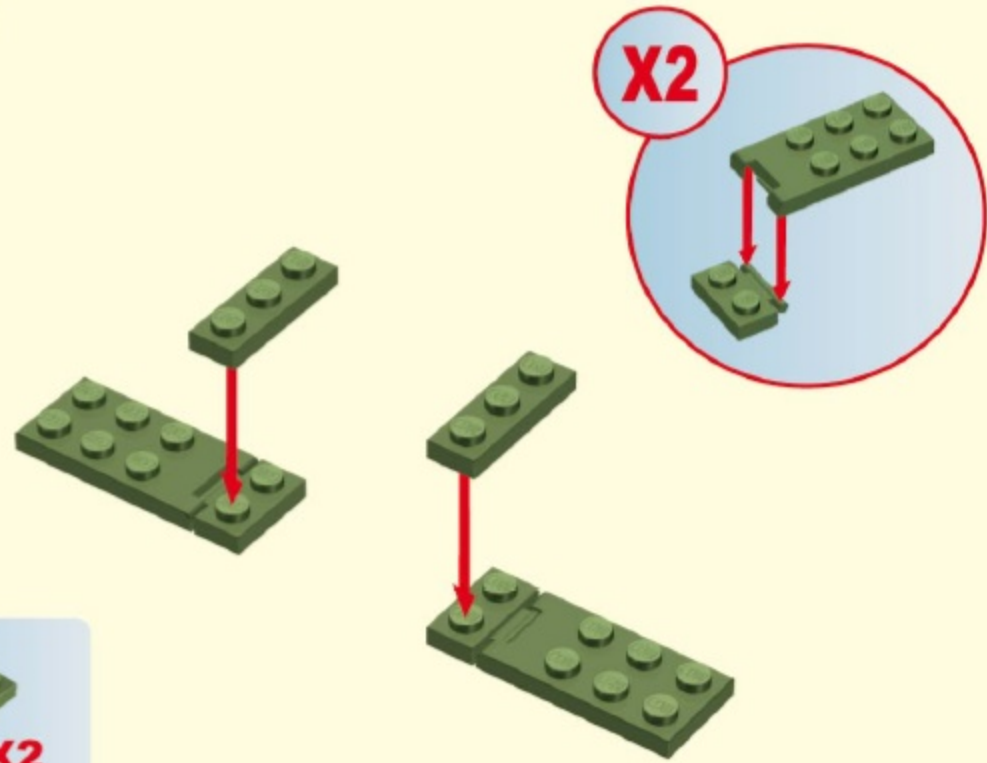

26

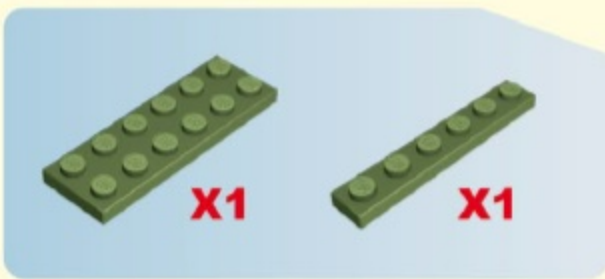
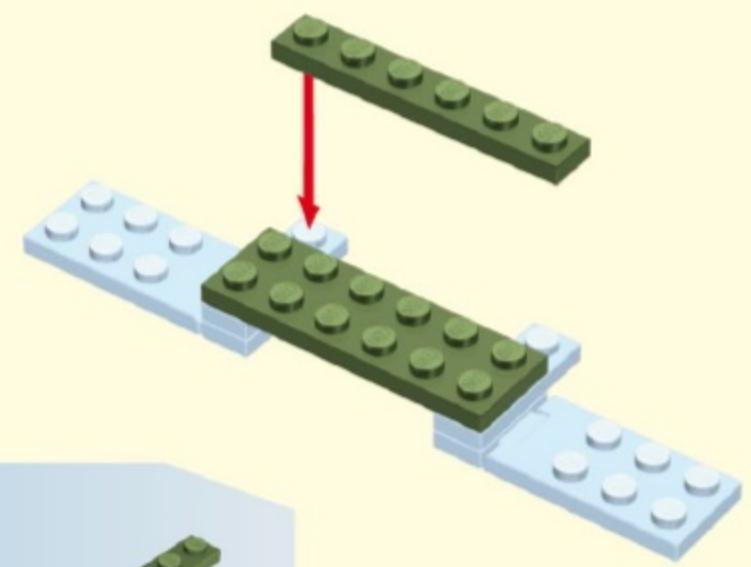

27

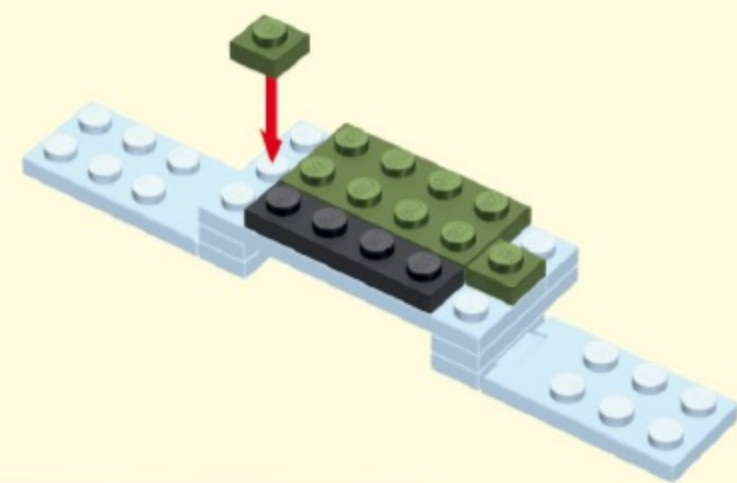

28

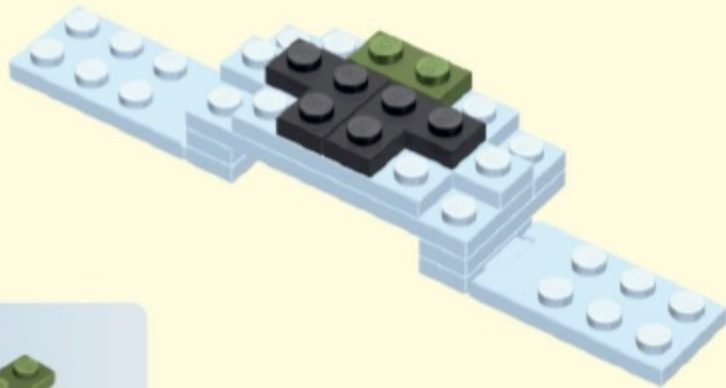

29

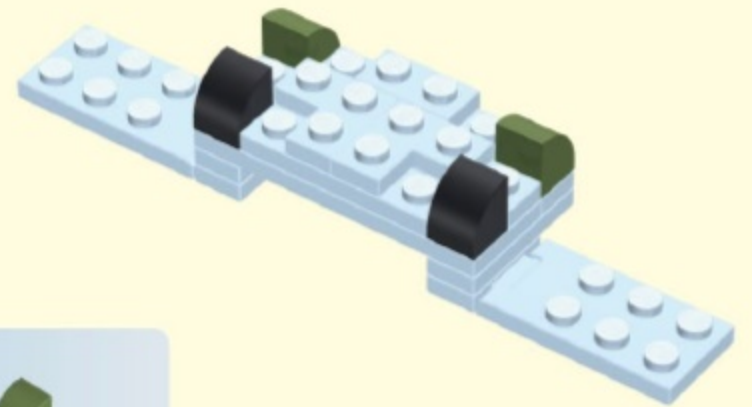

30

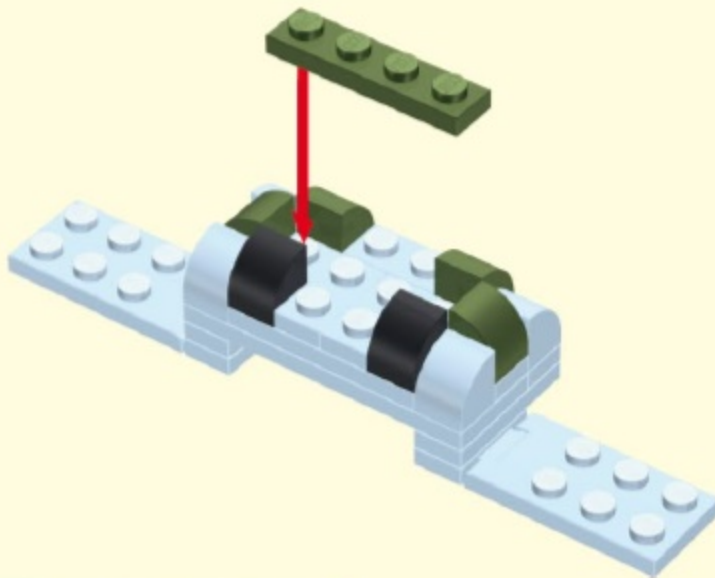

31

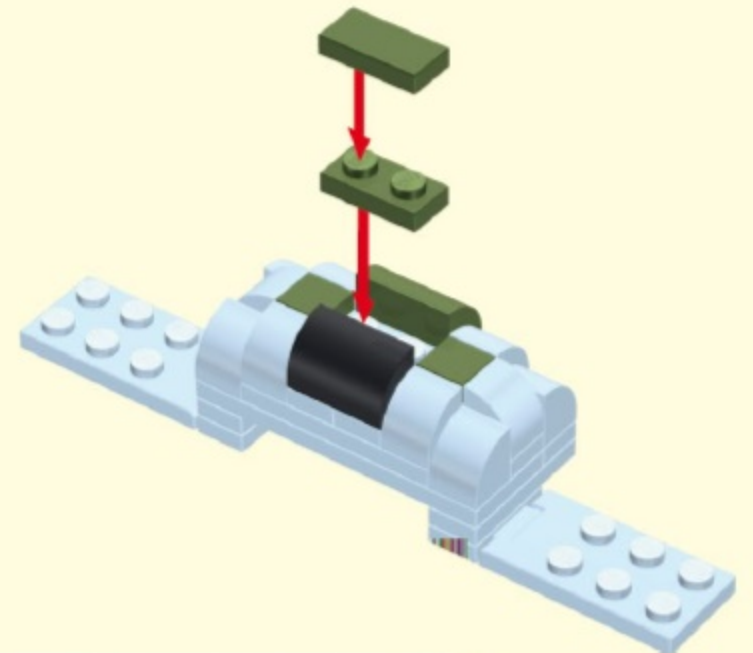

A B + C

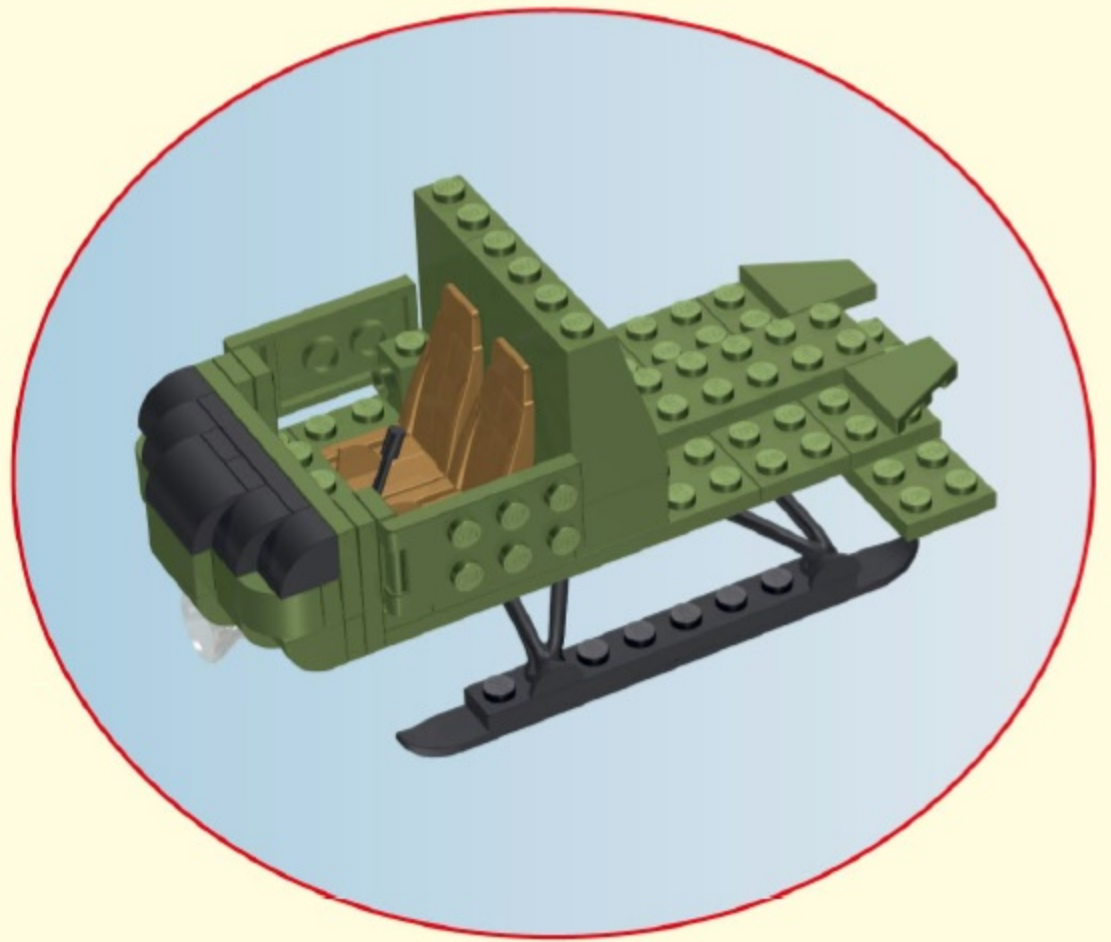
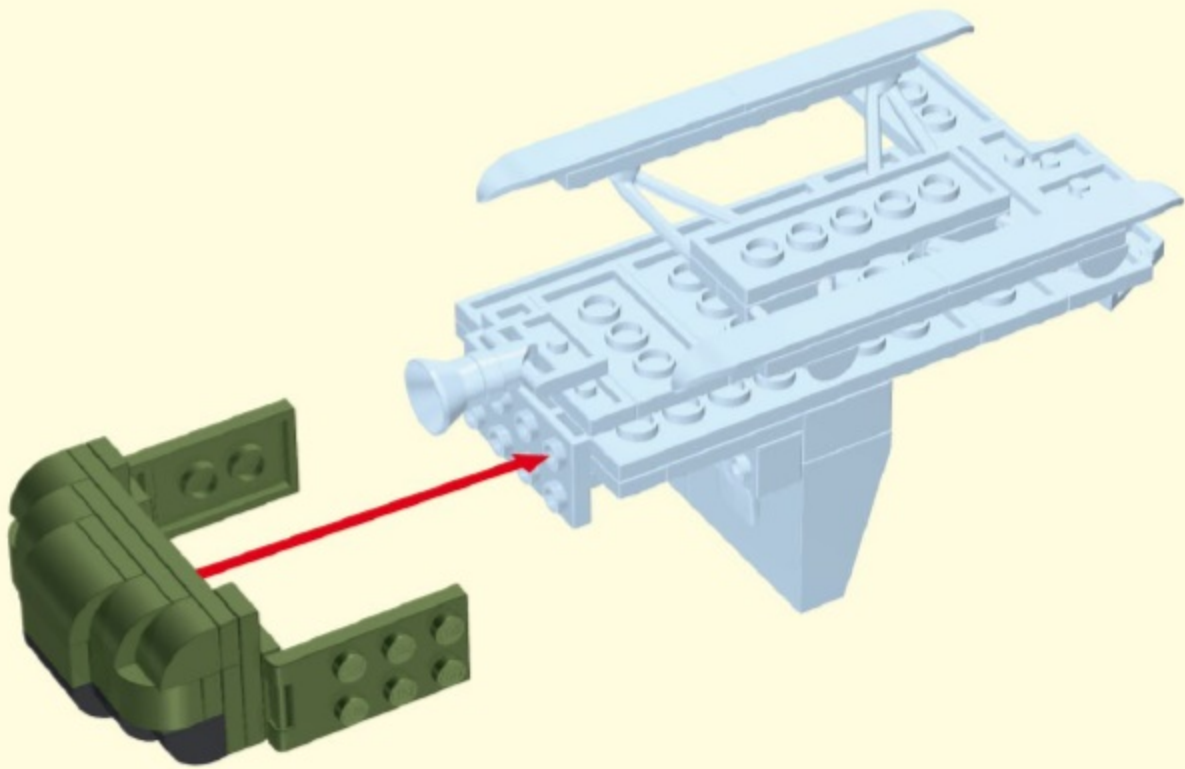

D

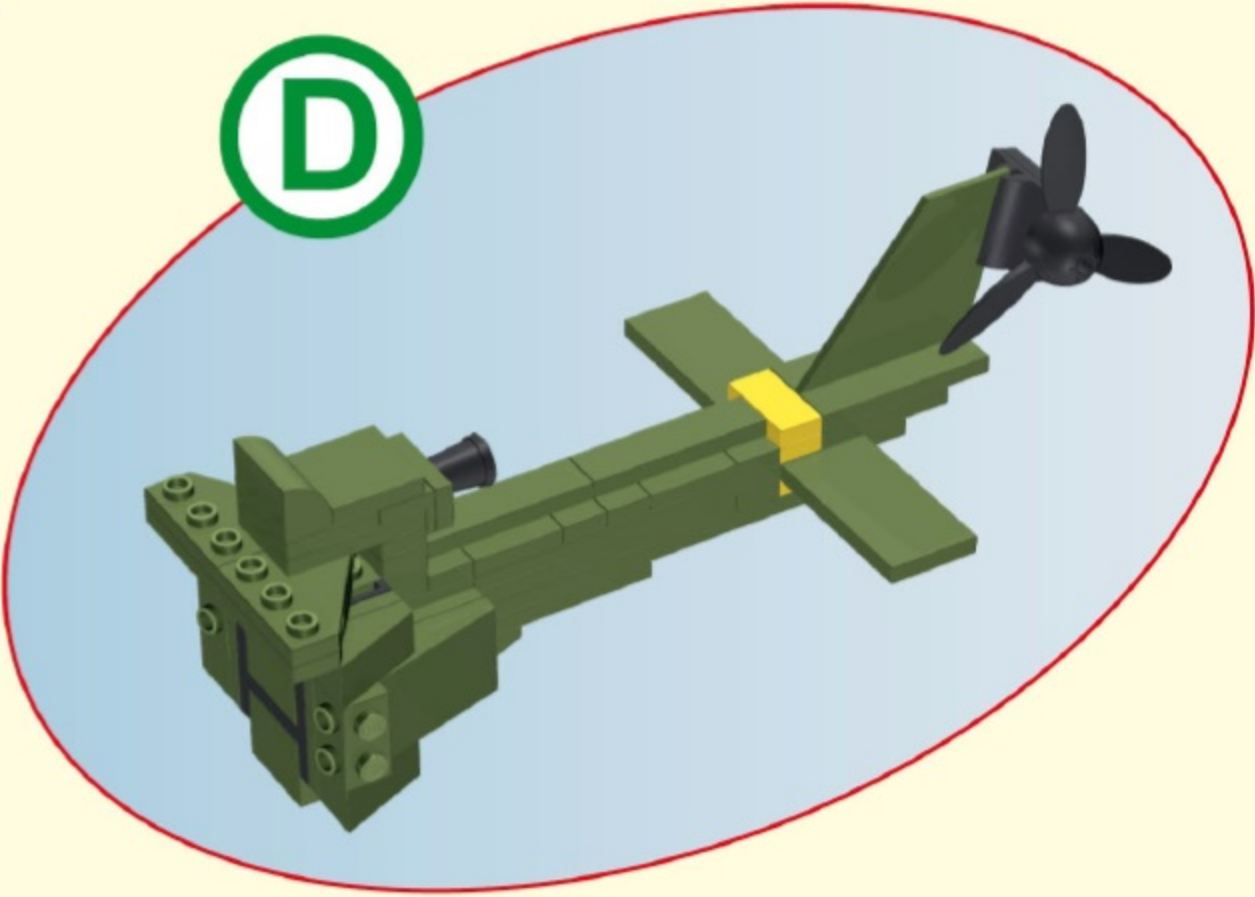

33

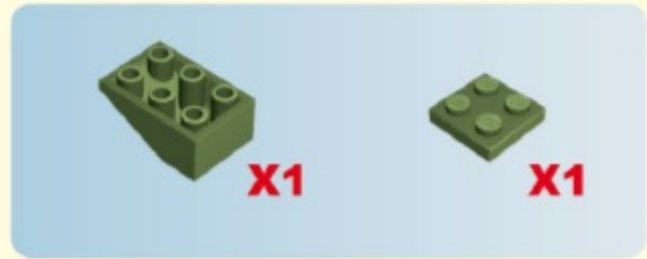
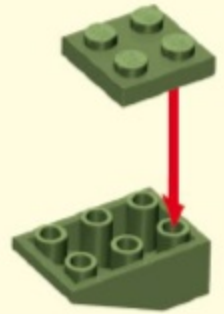

34

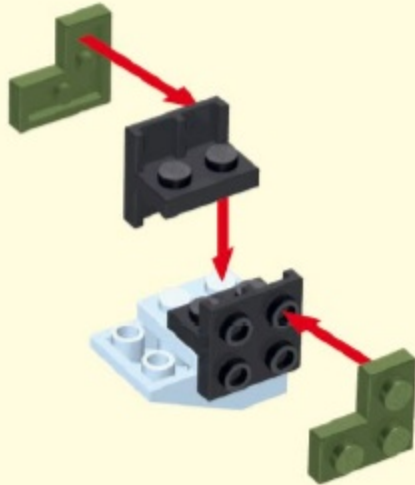

35

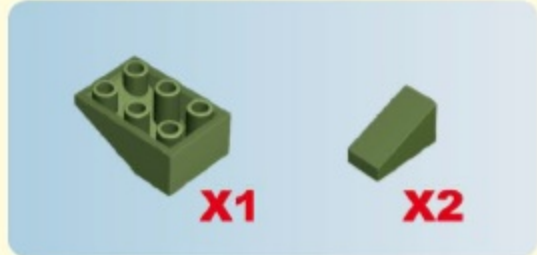
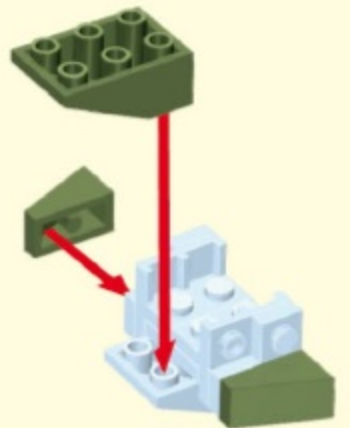

36

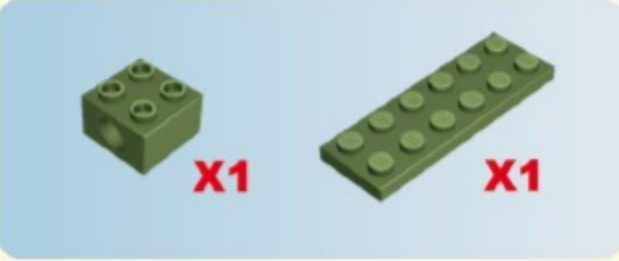
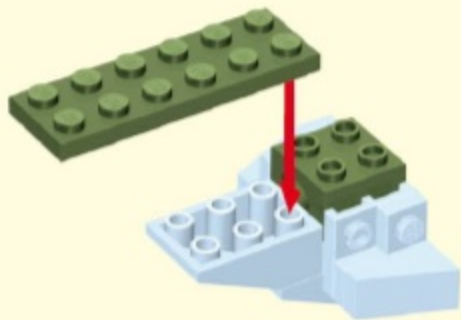

37

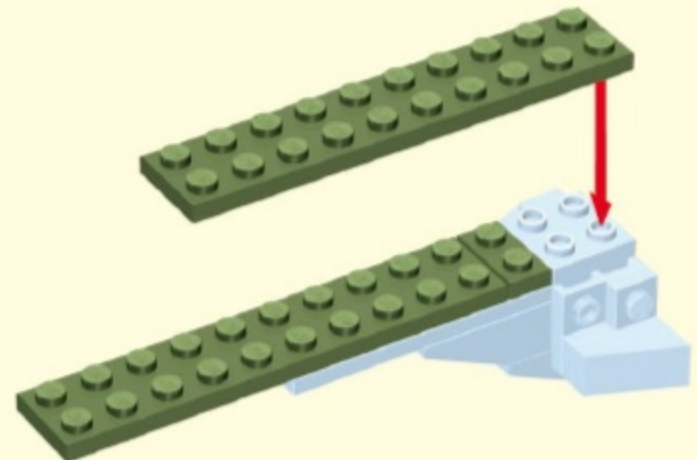
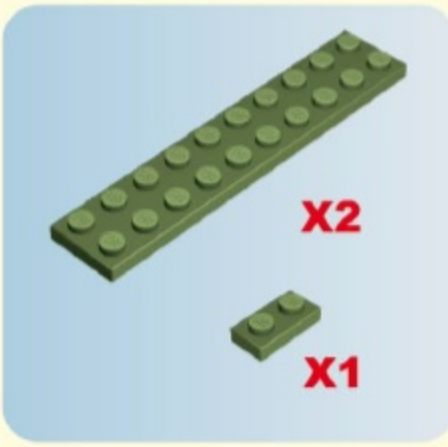

38

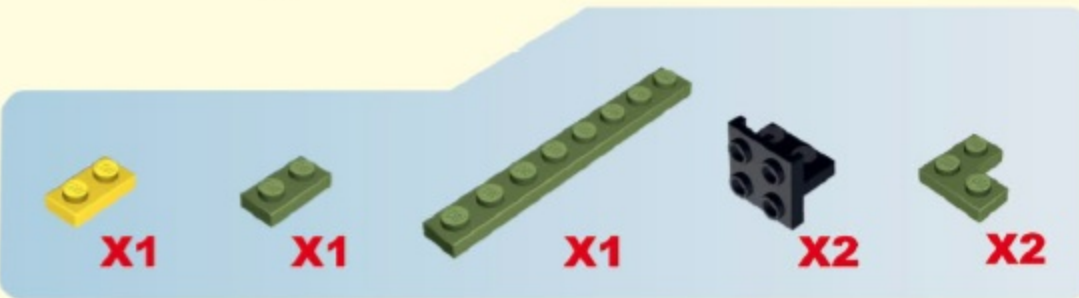
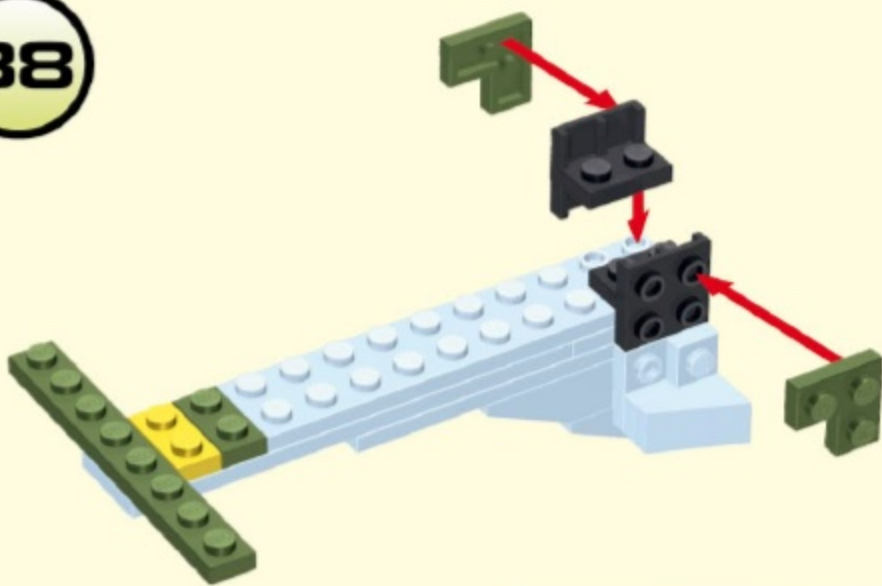

39

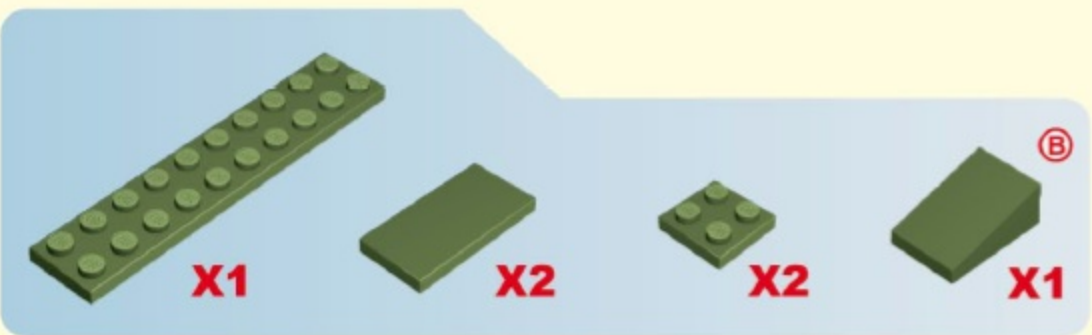
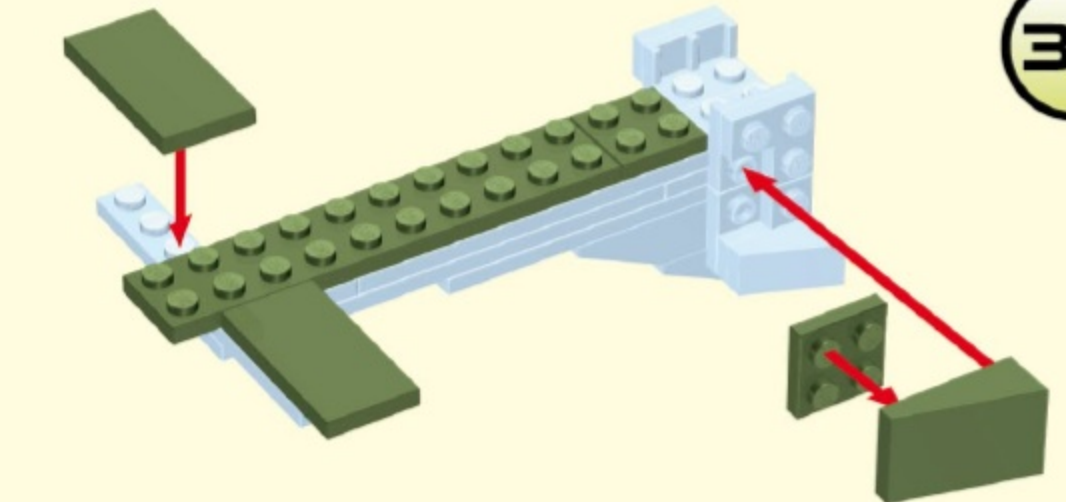

40

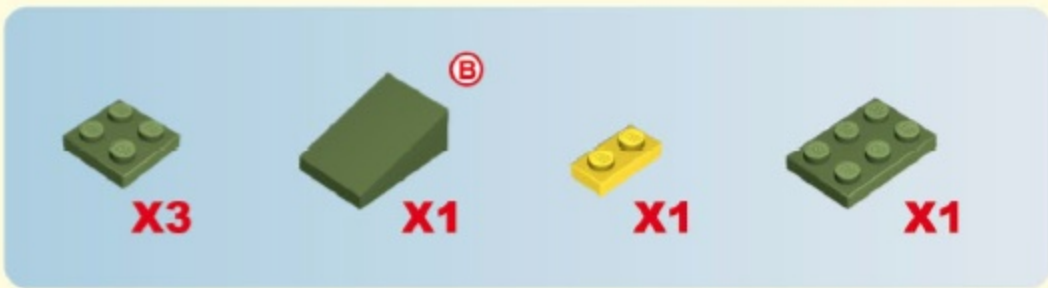
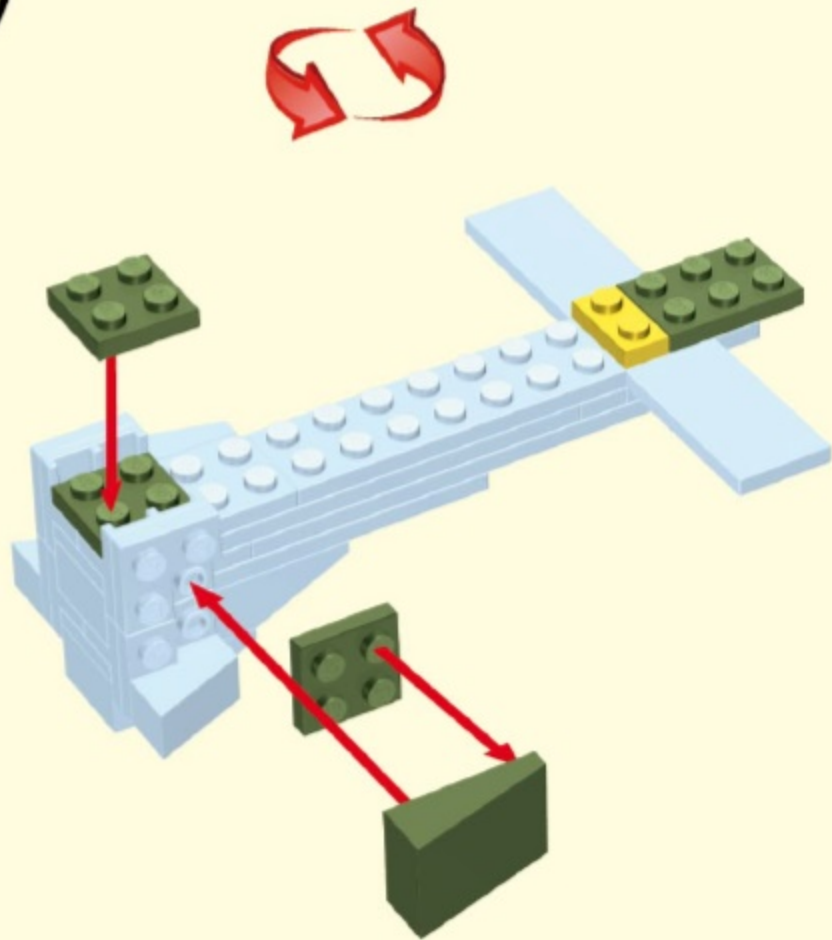

41

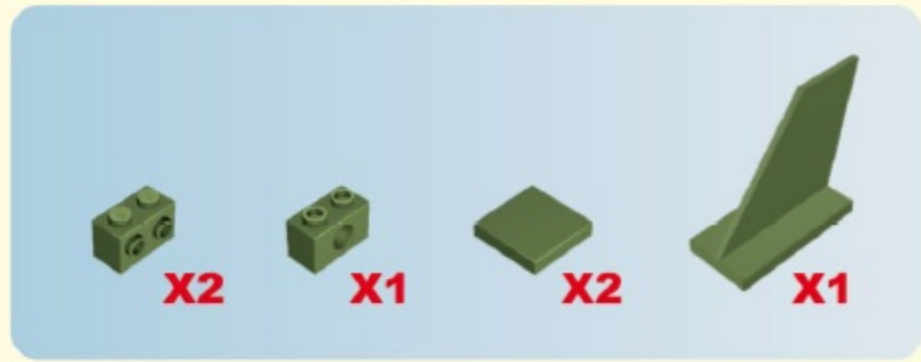
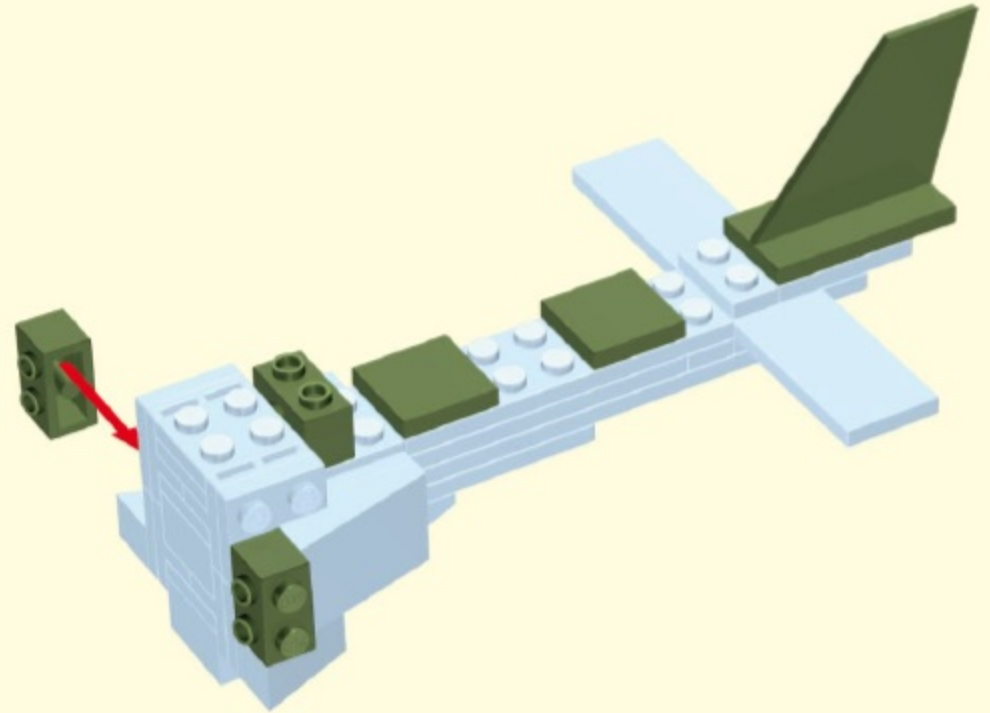

42

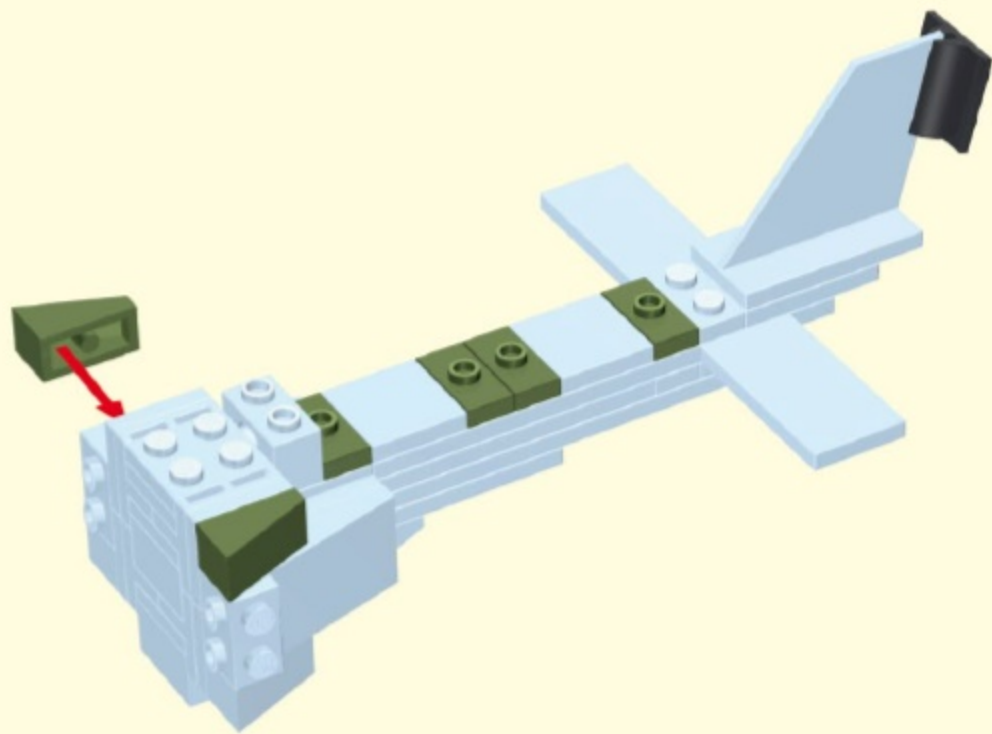

43

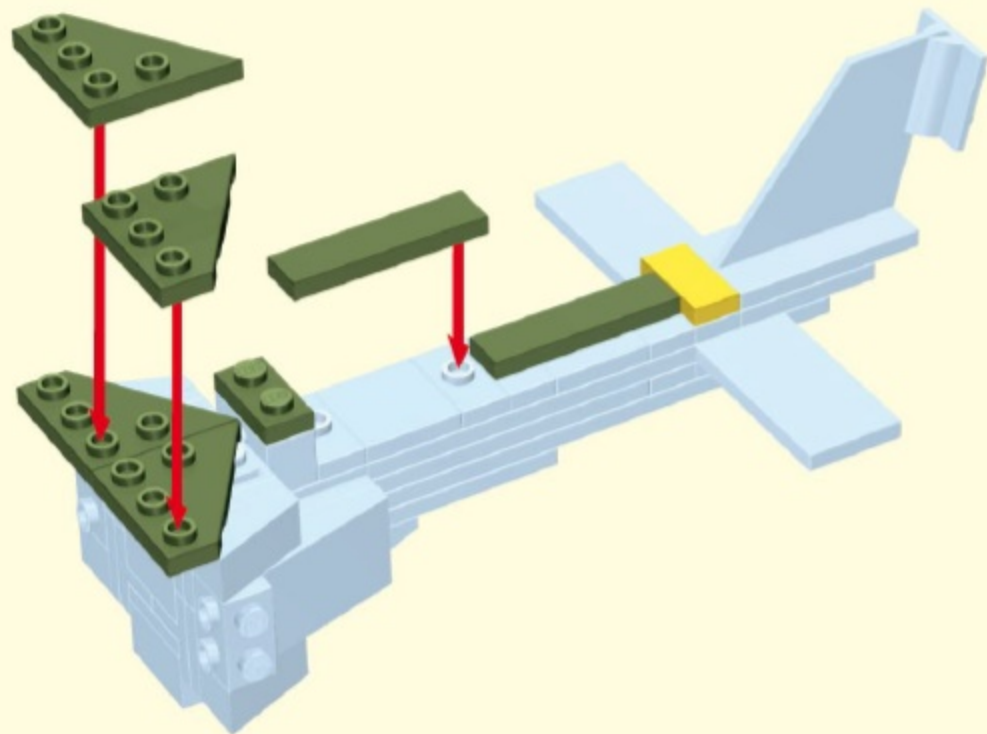

44

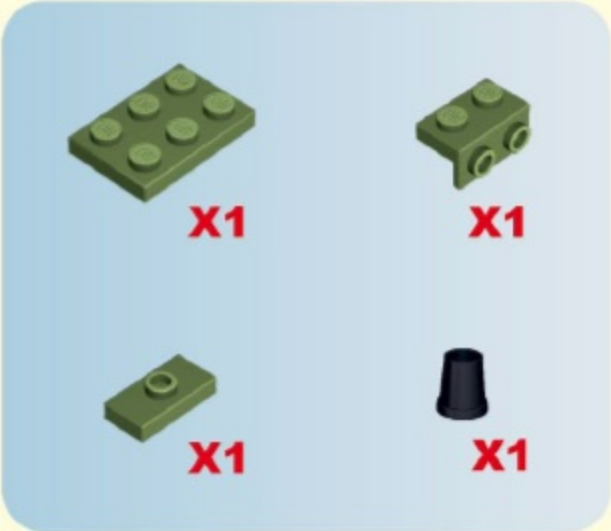
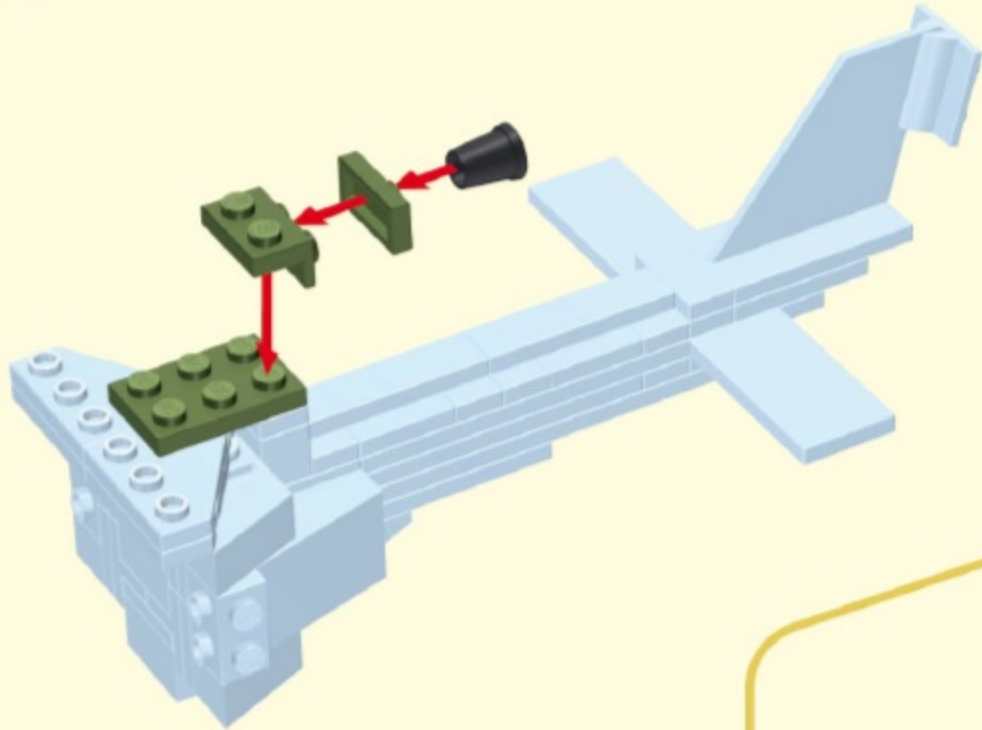

45

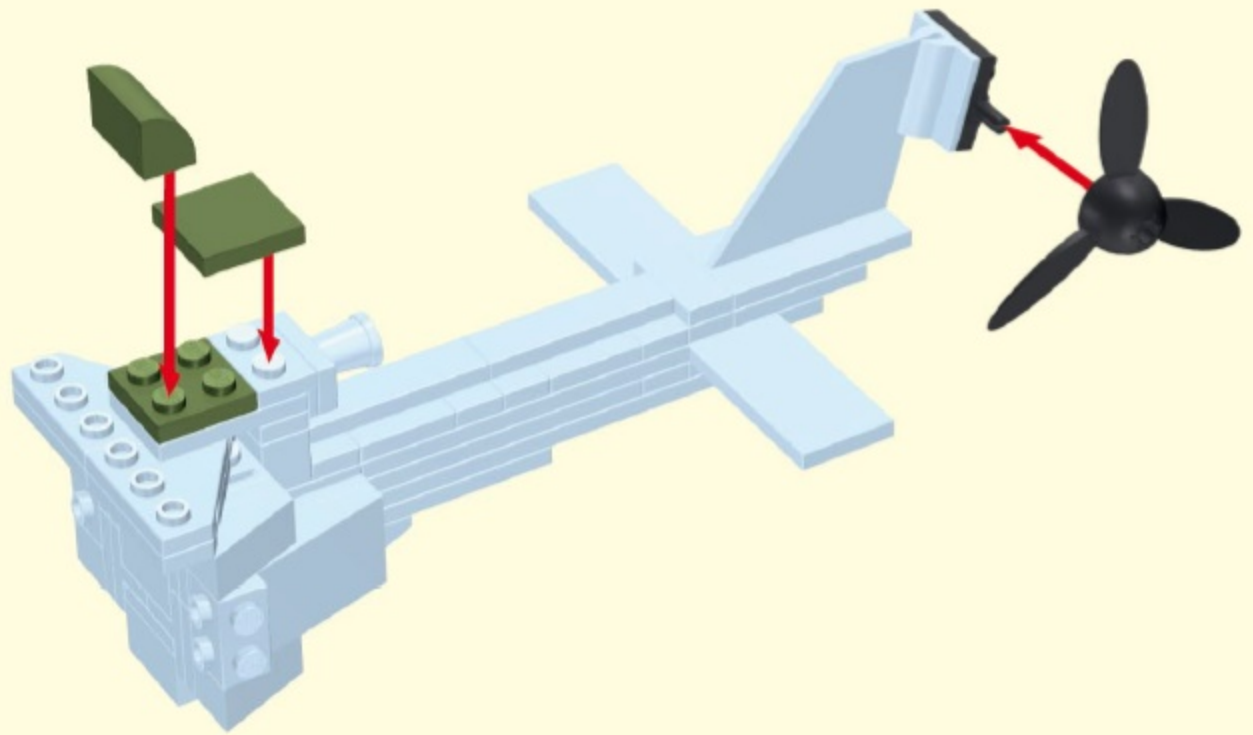
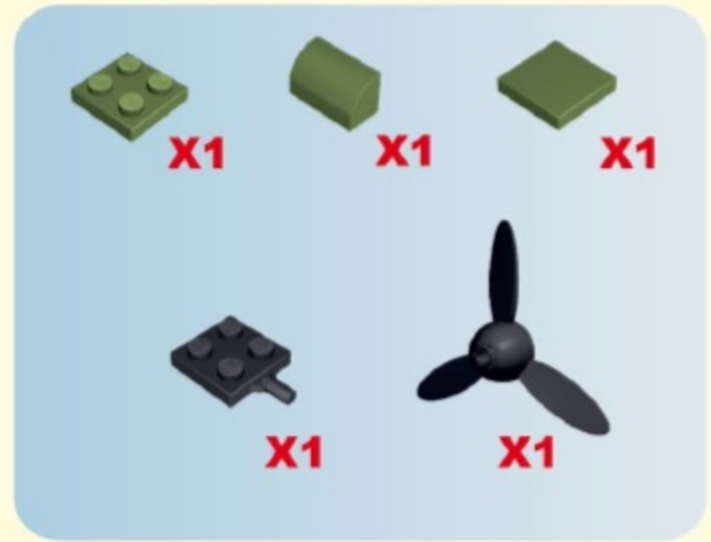

46

E

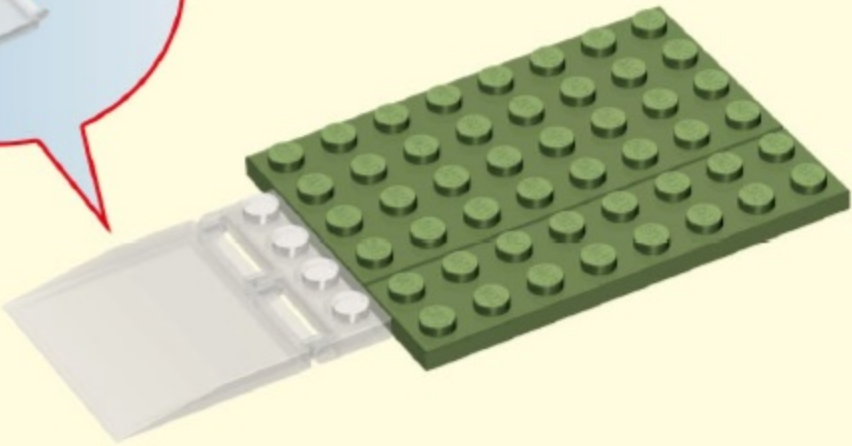
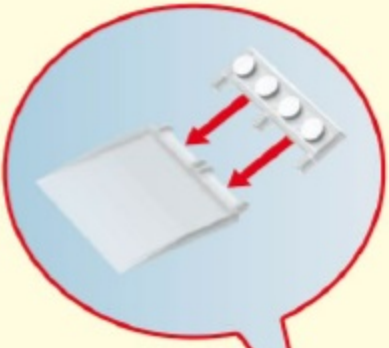
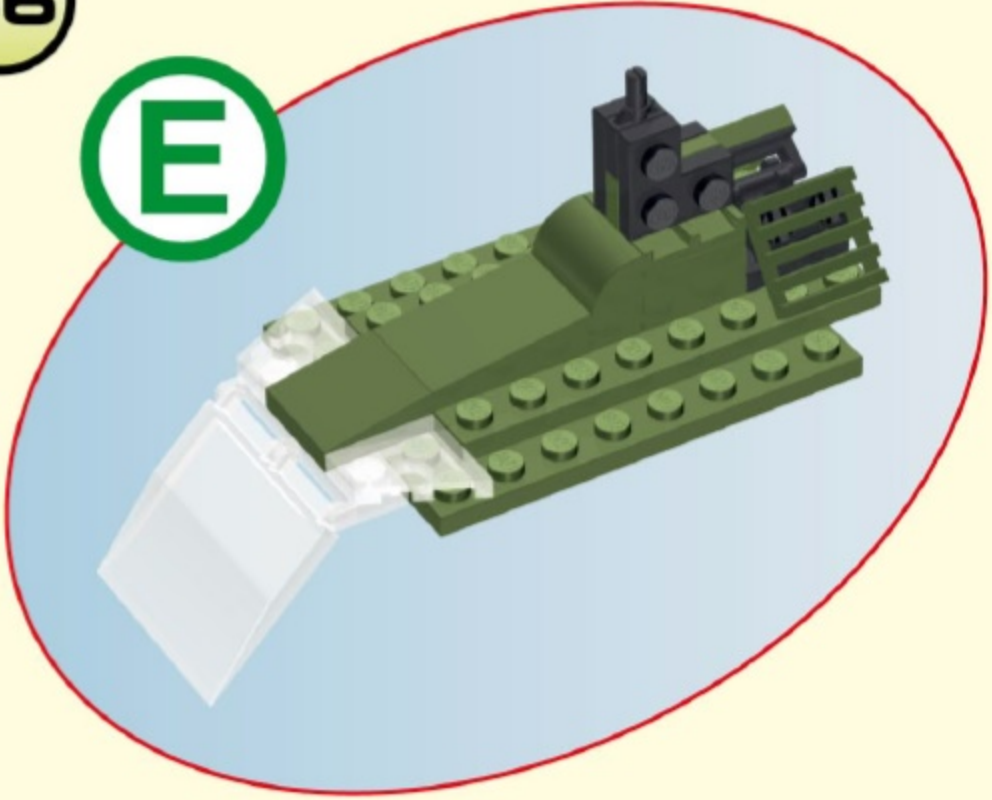

47

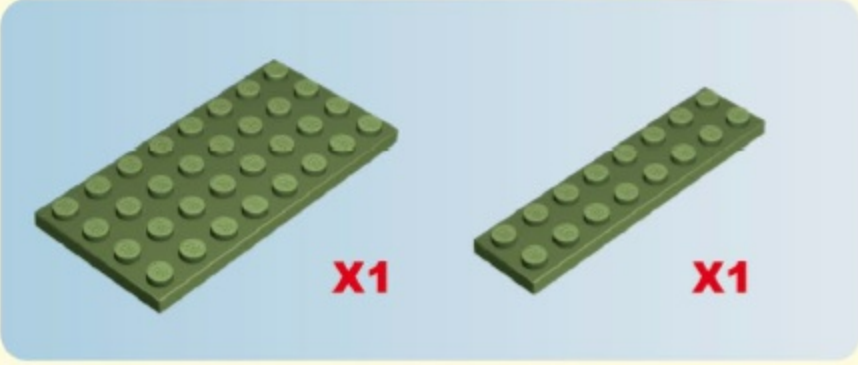
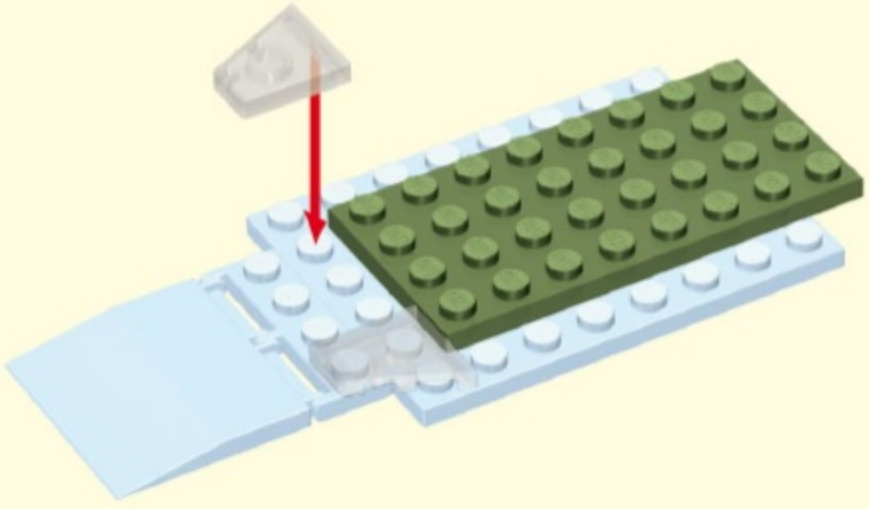

48

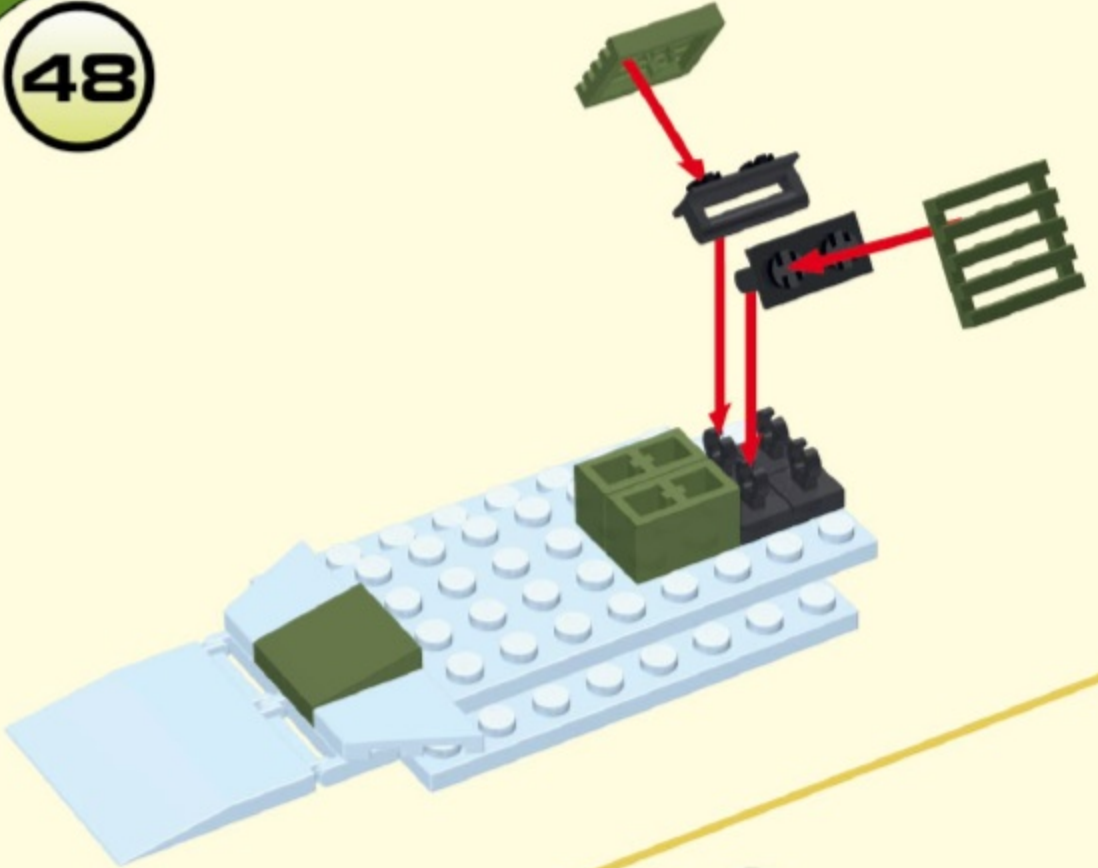

49

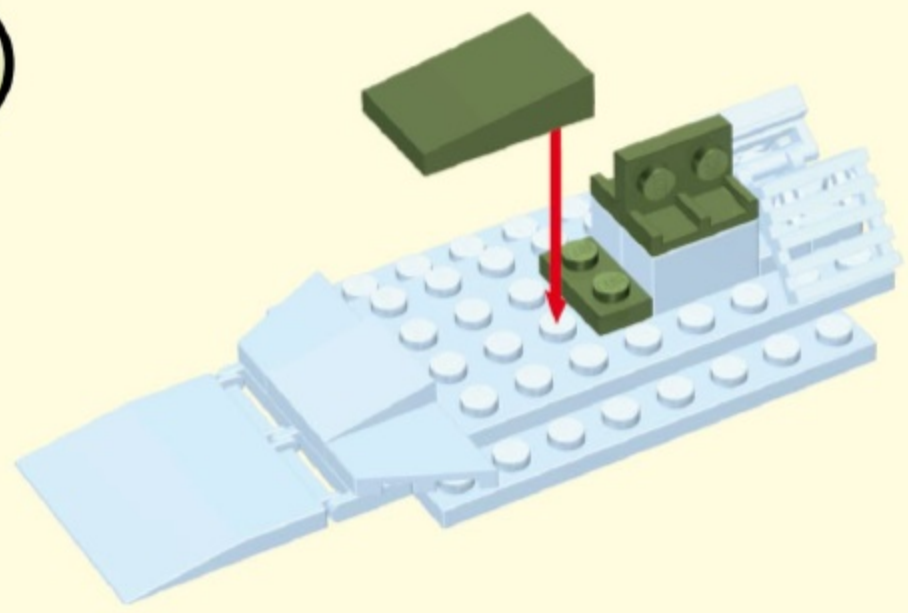

50

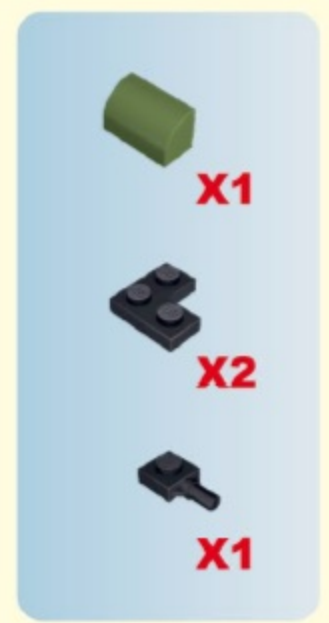
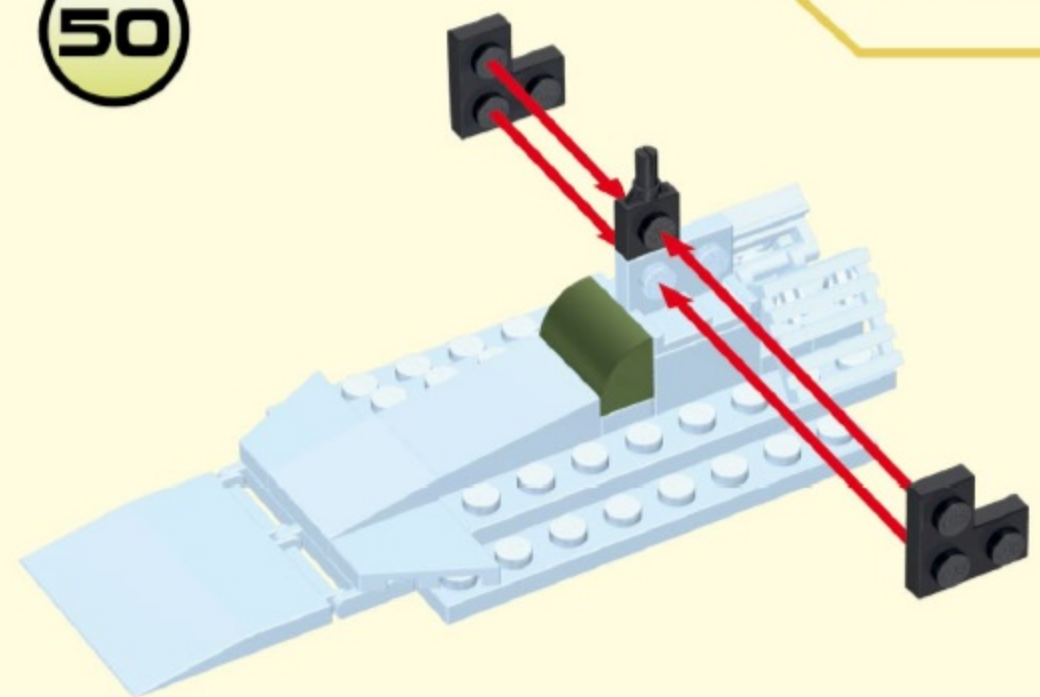

(A)(B)(C) + (D) + (E)

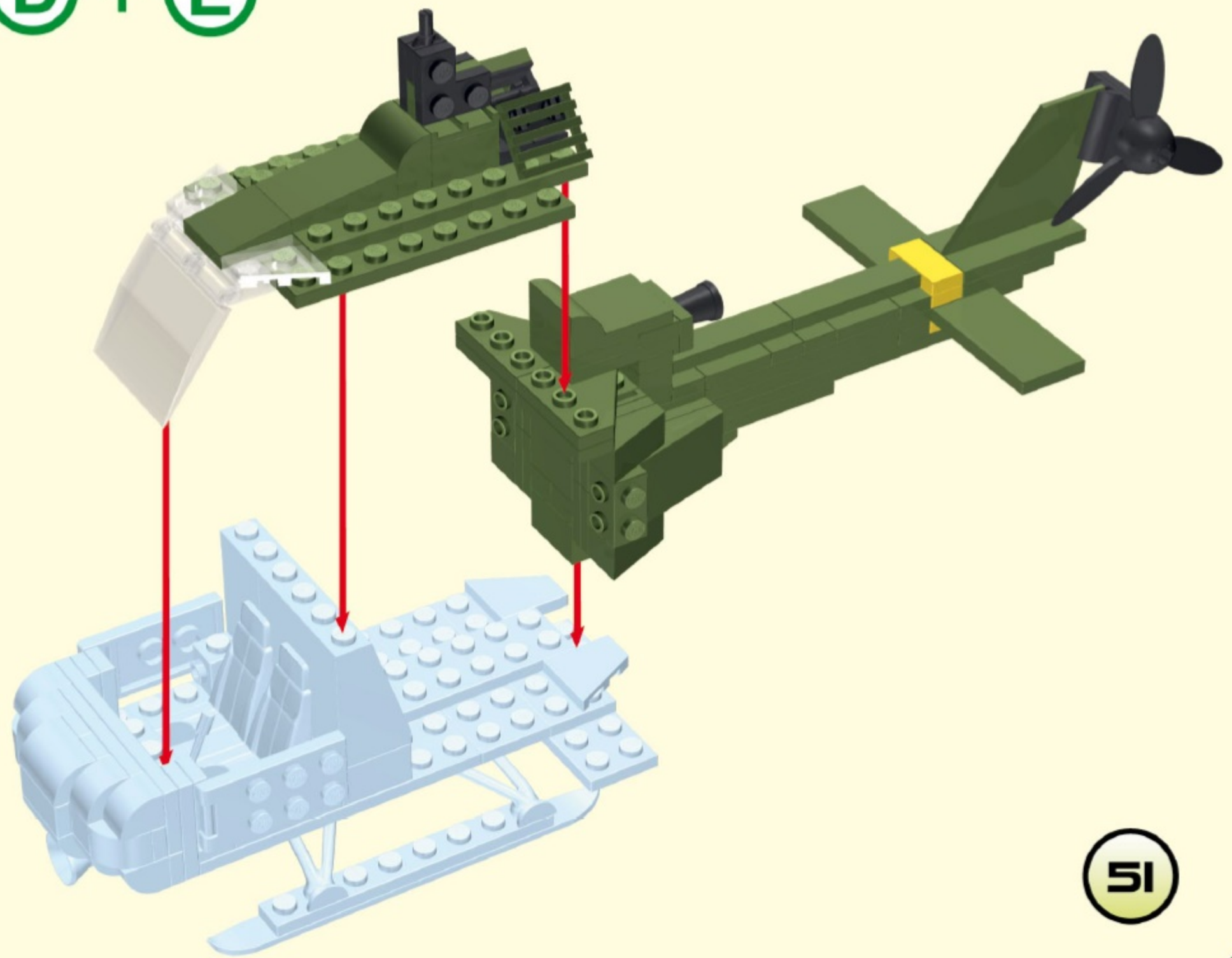

52

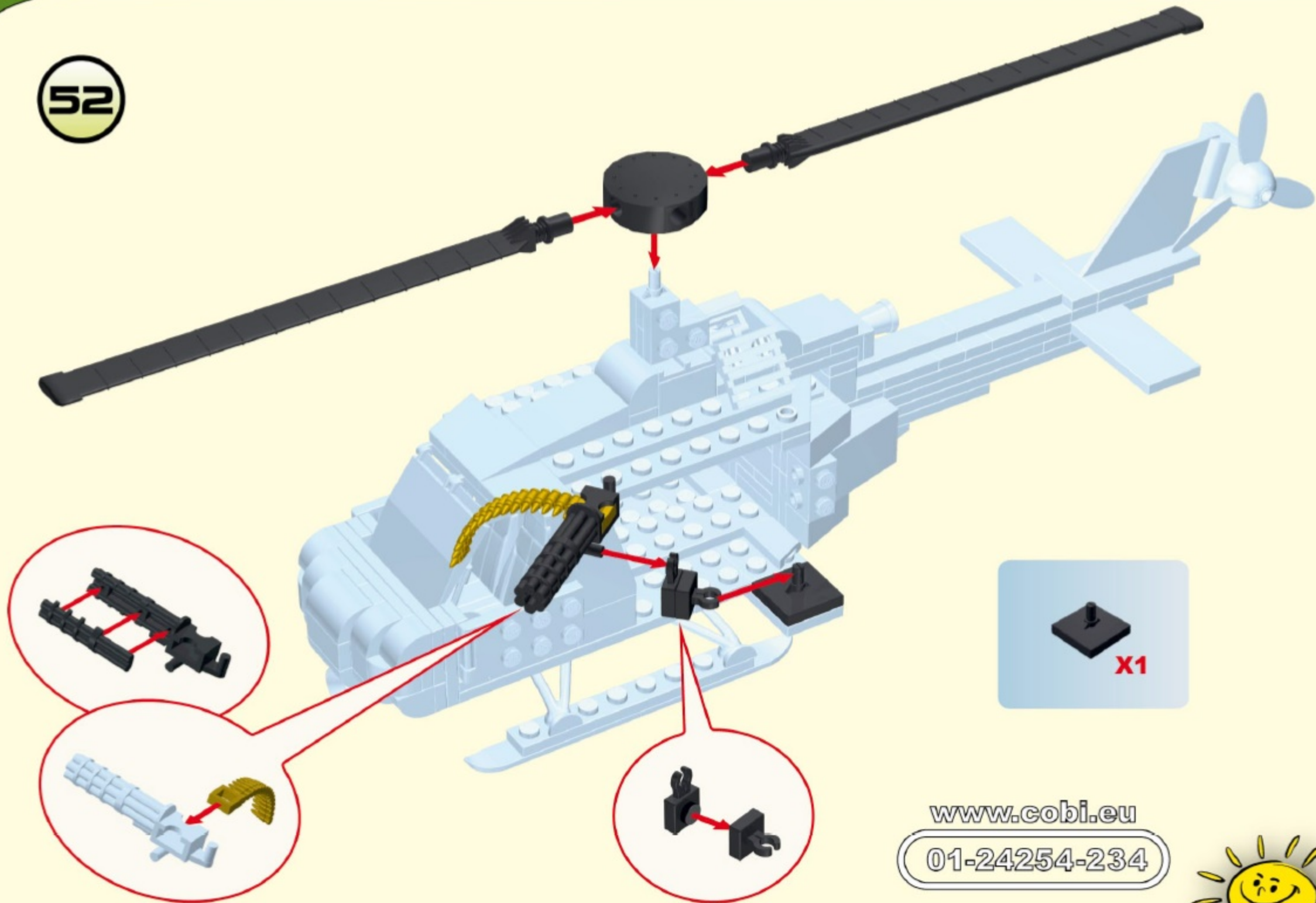

www.cobi.eu

01-24254-234

