



22301



WILD STORY 2



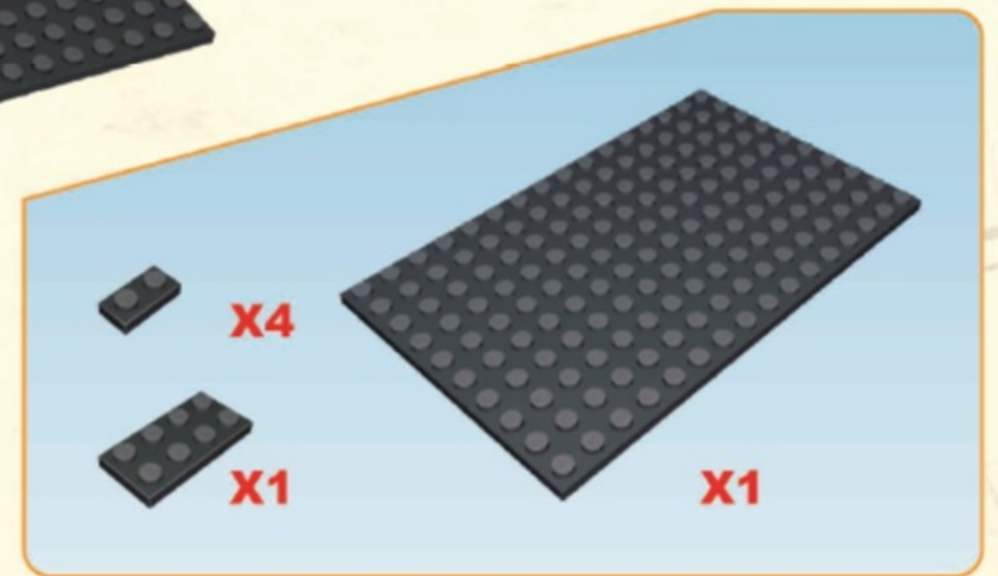
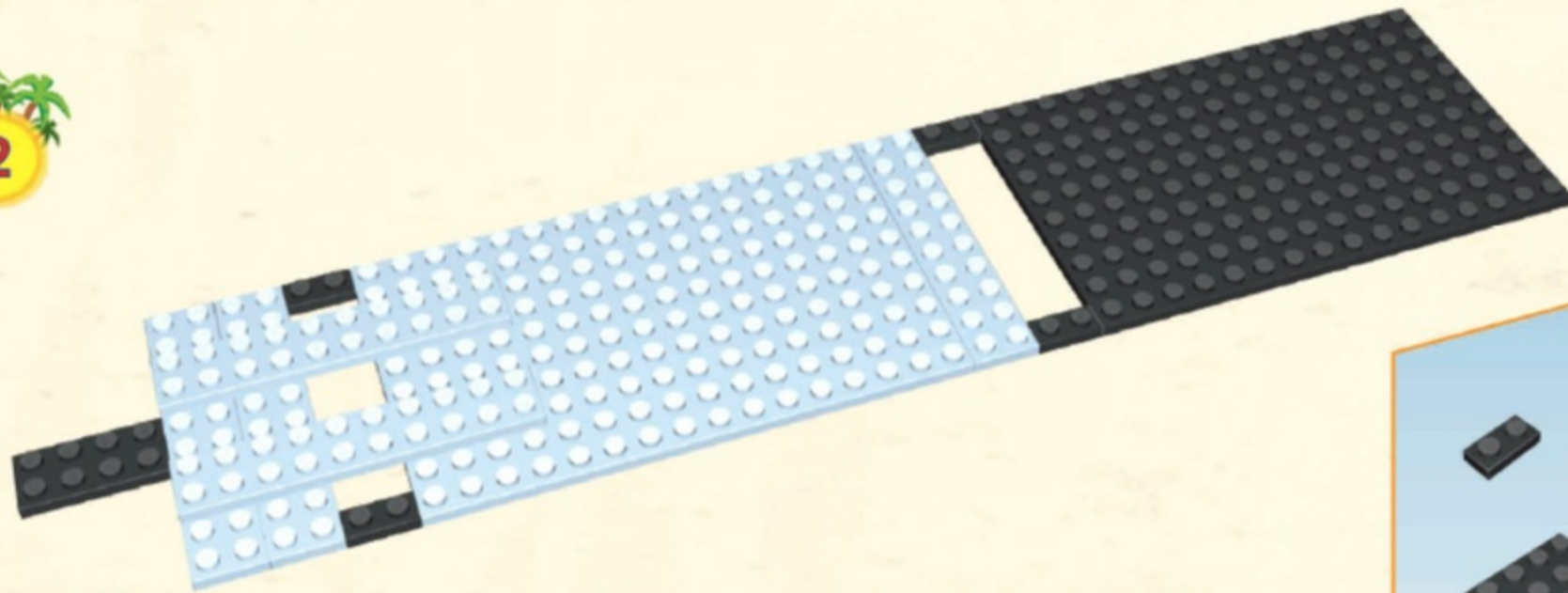
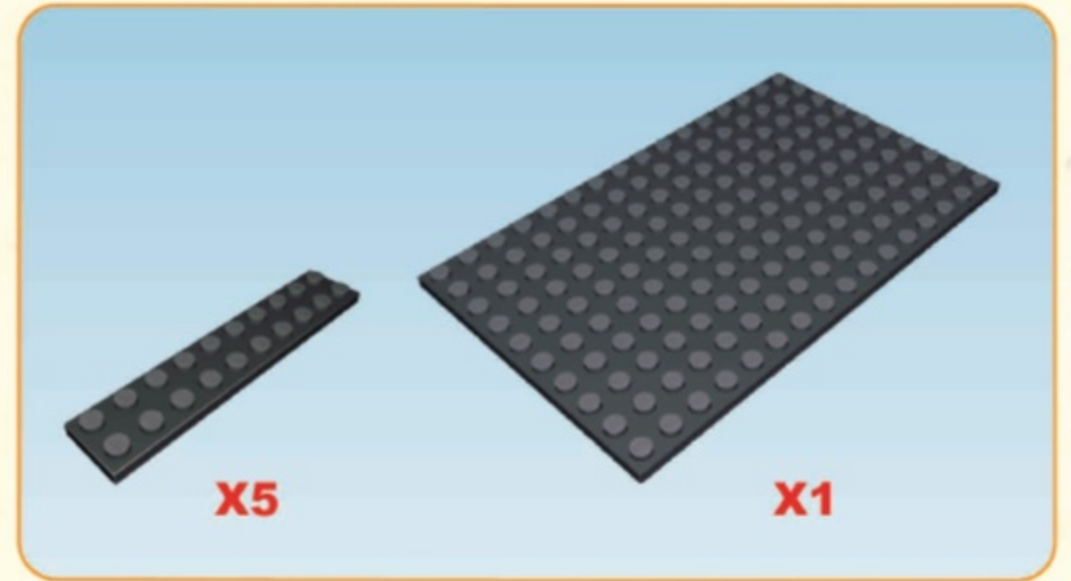
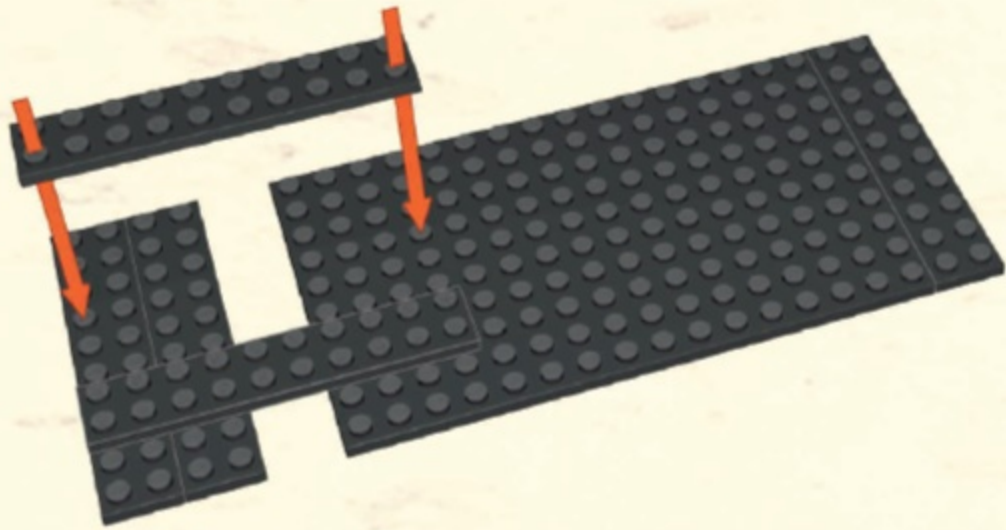

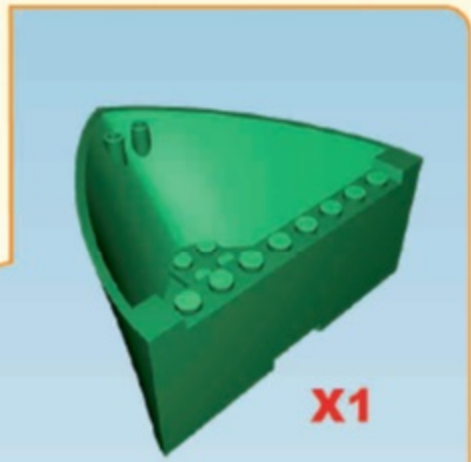
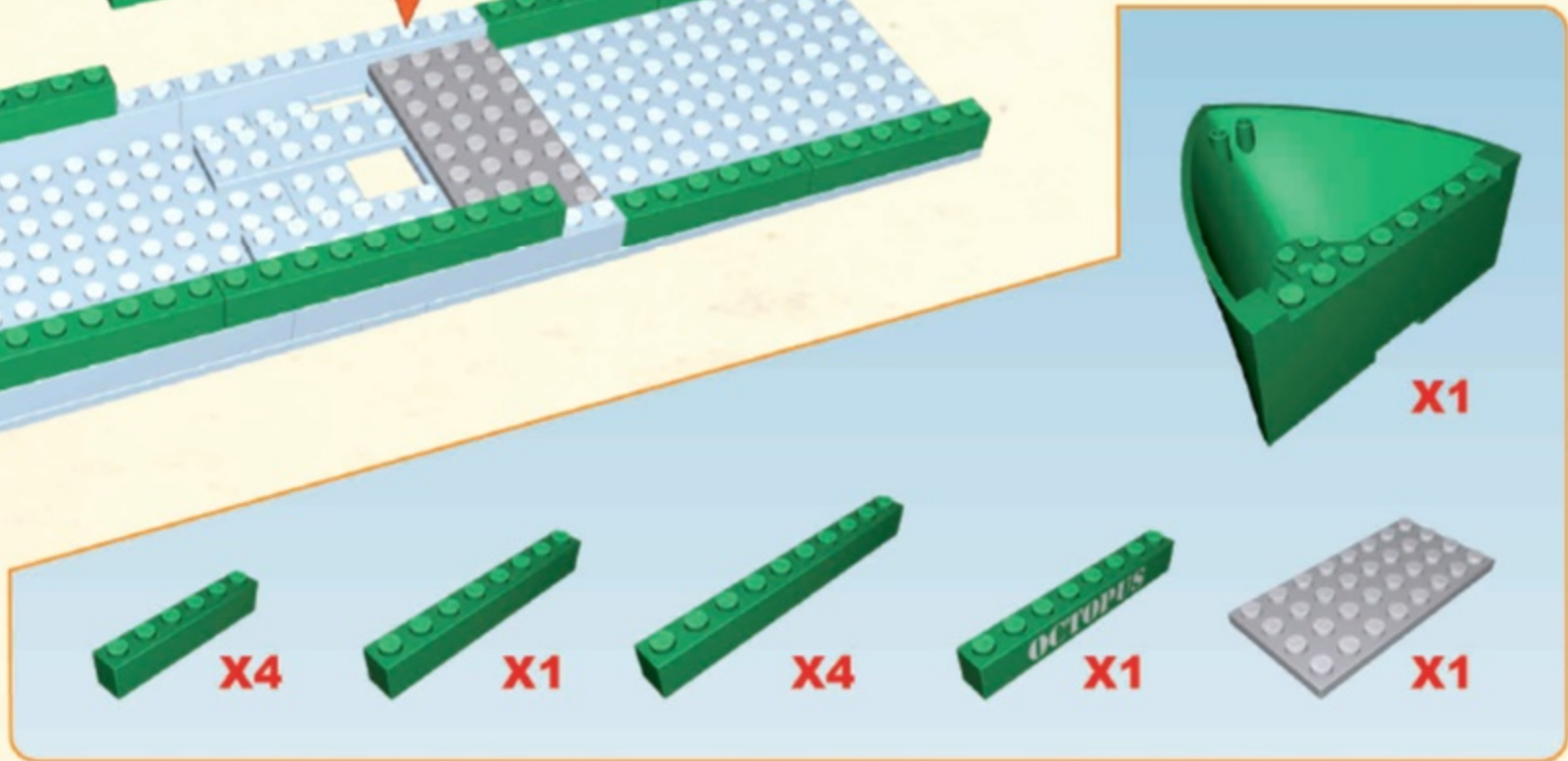
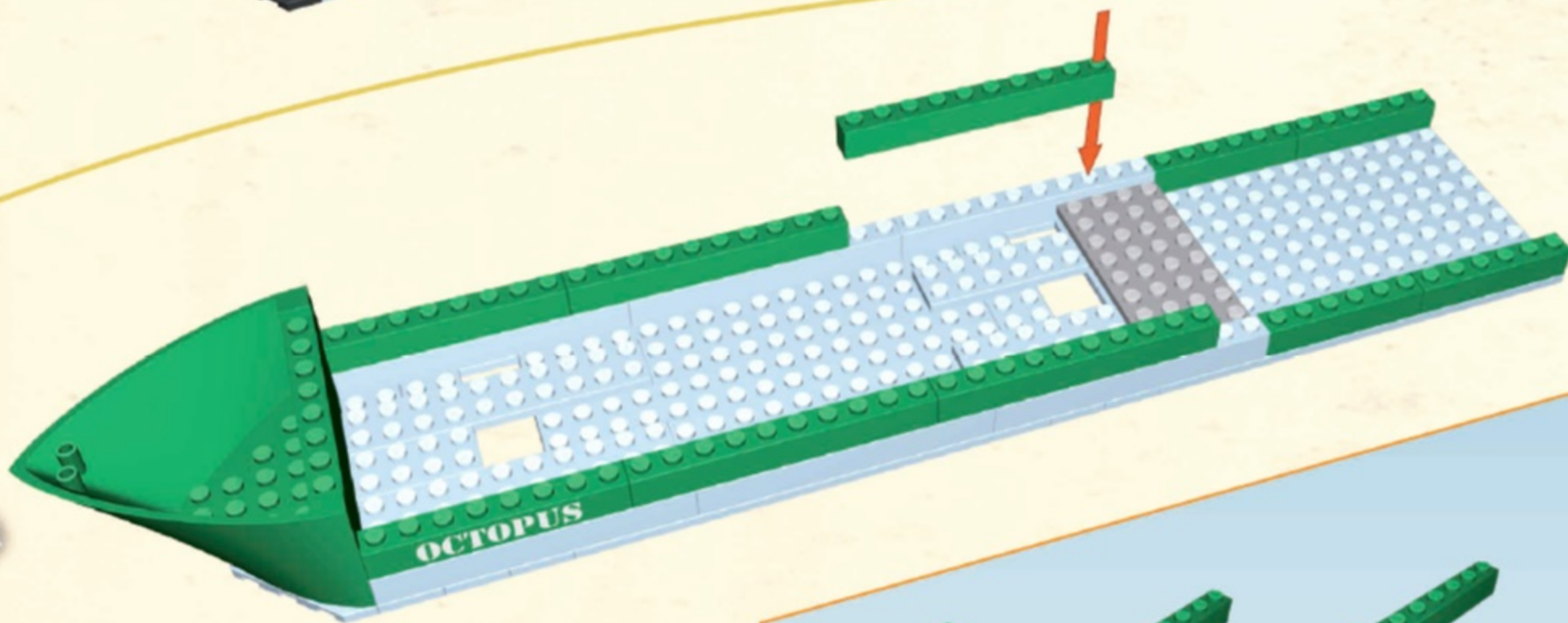
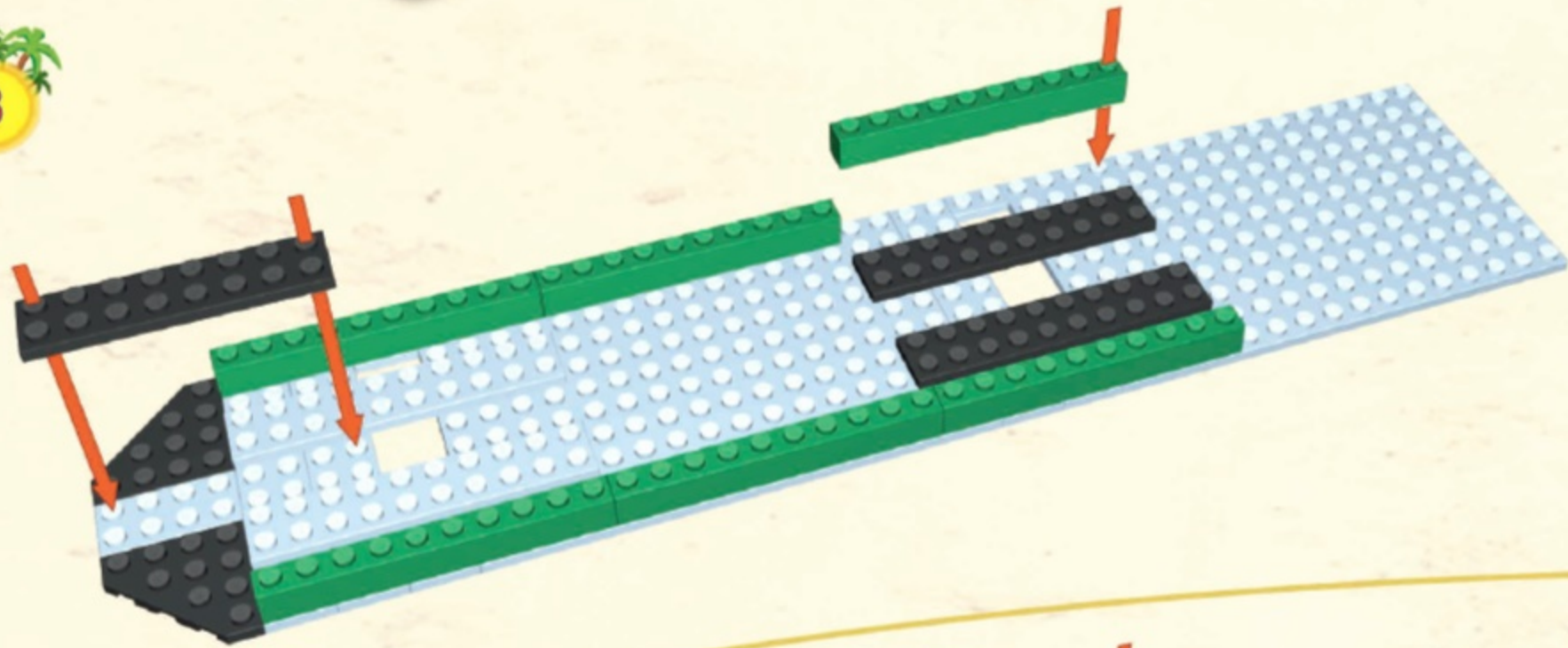

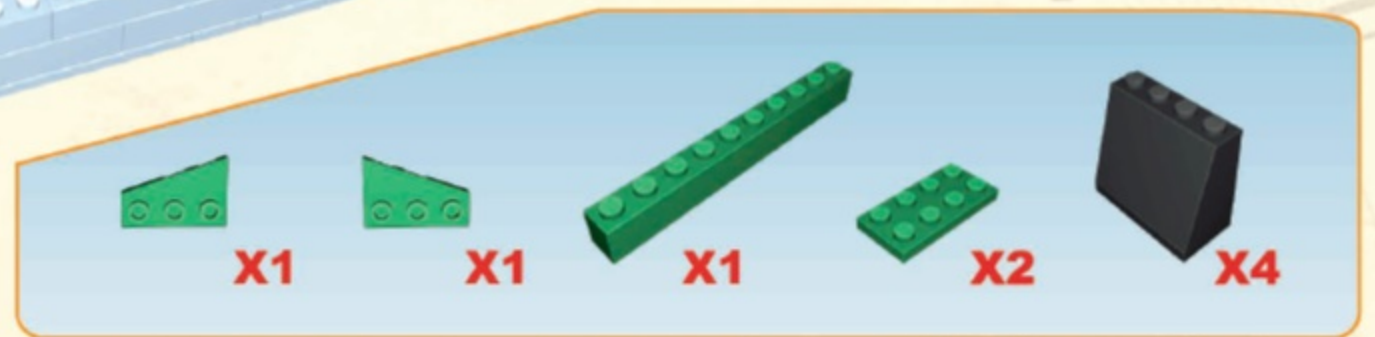
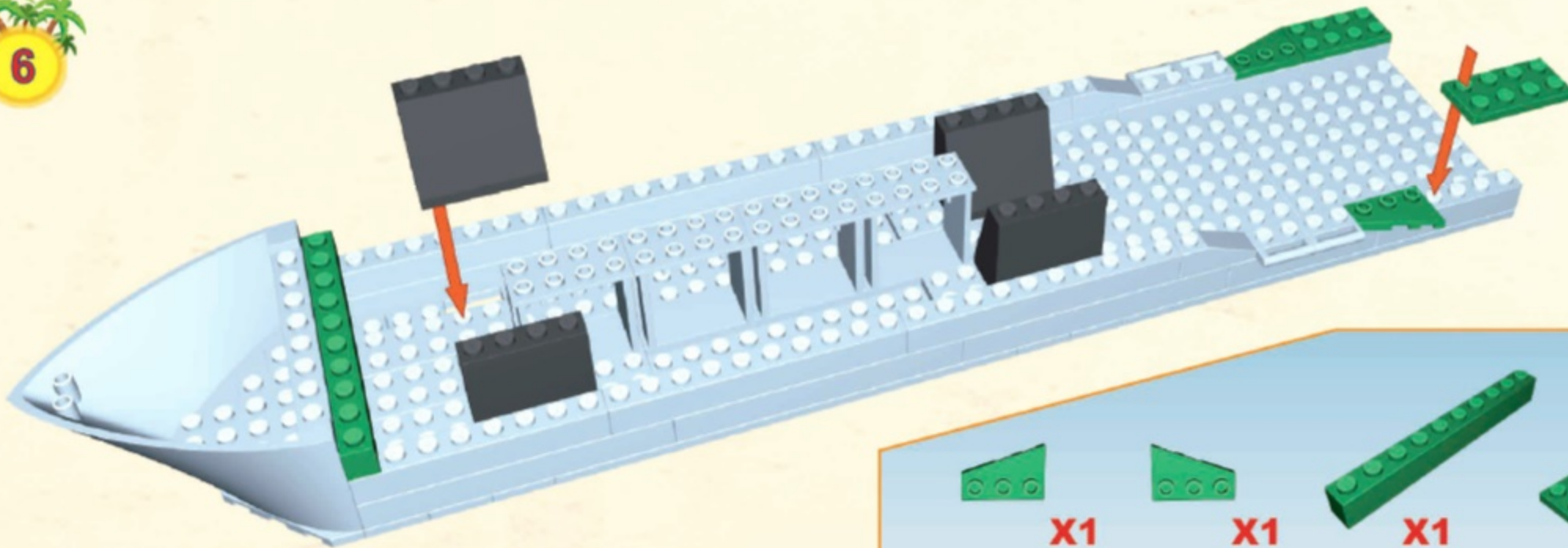
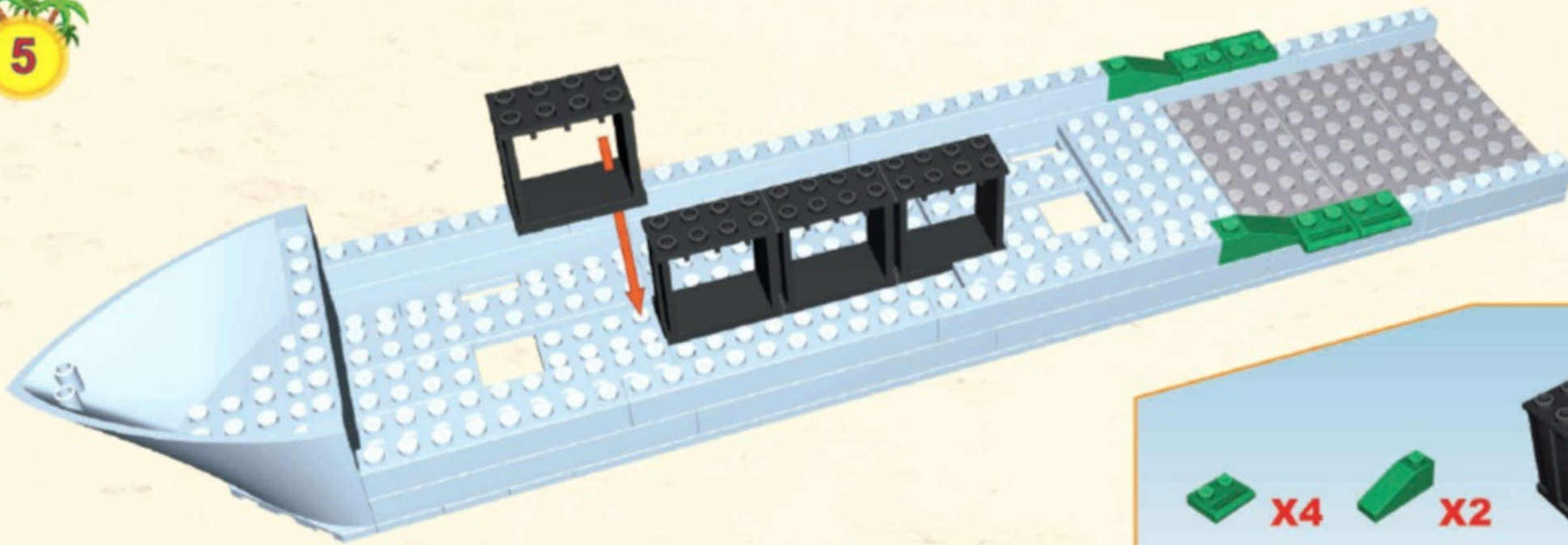

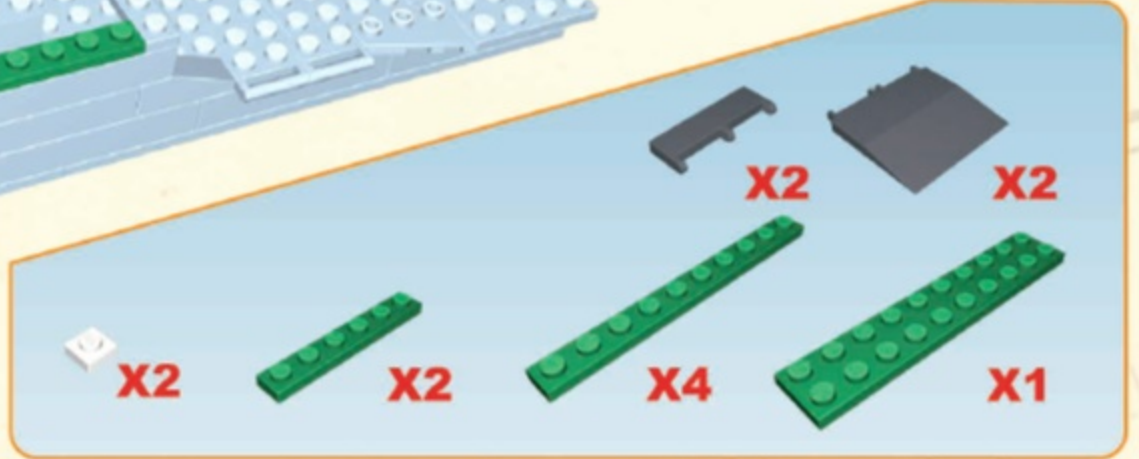
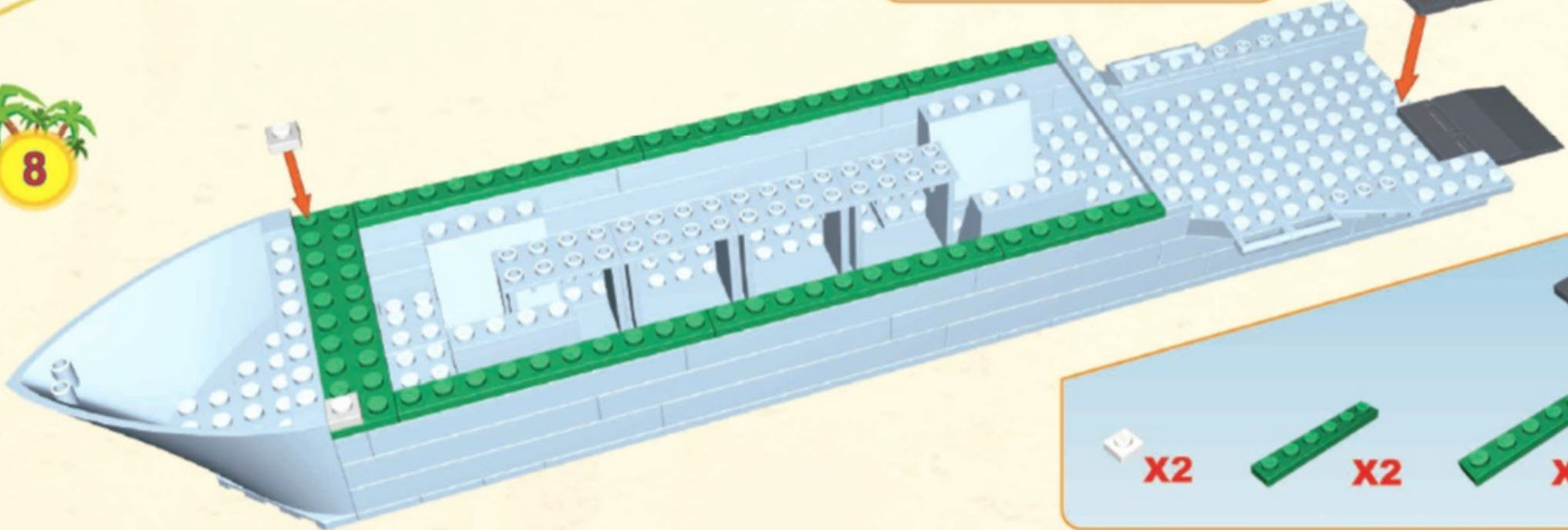
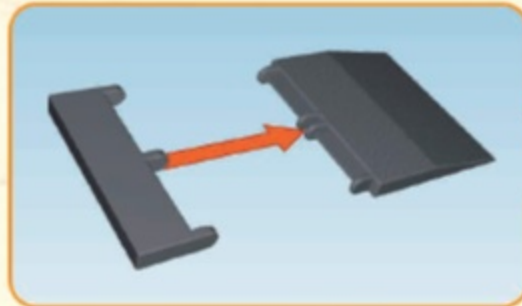
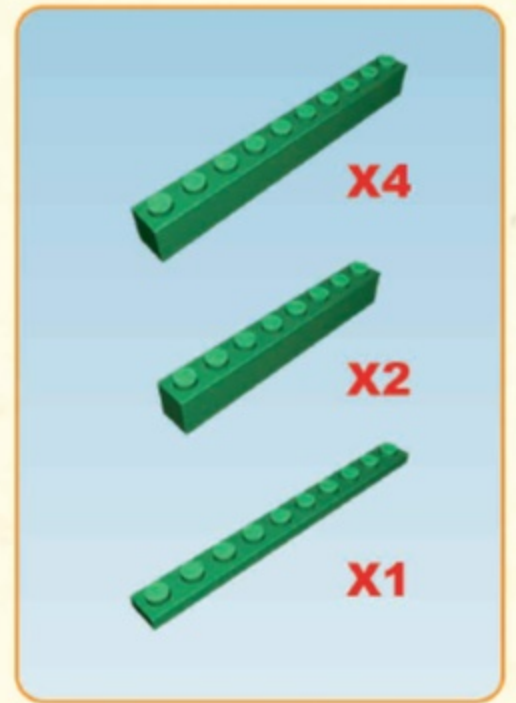
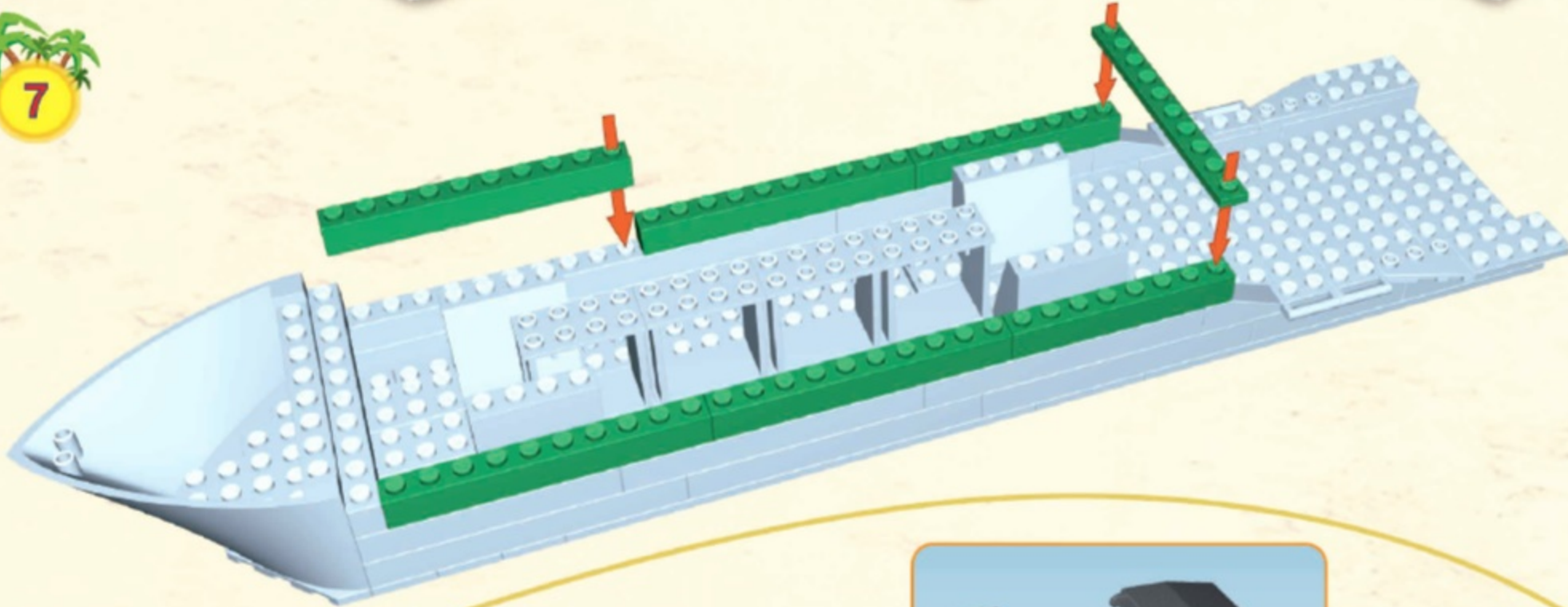

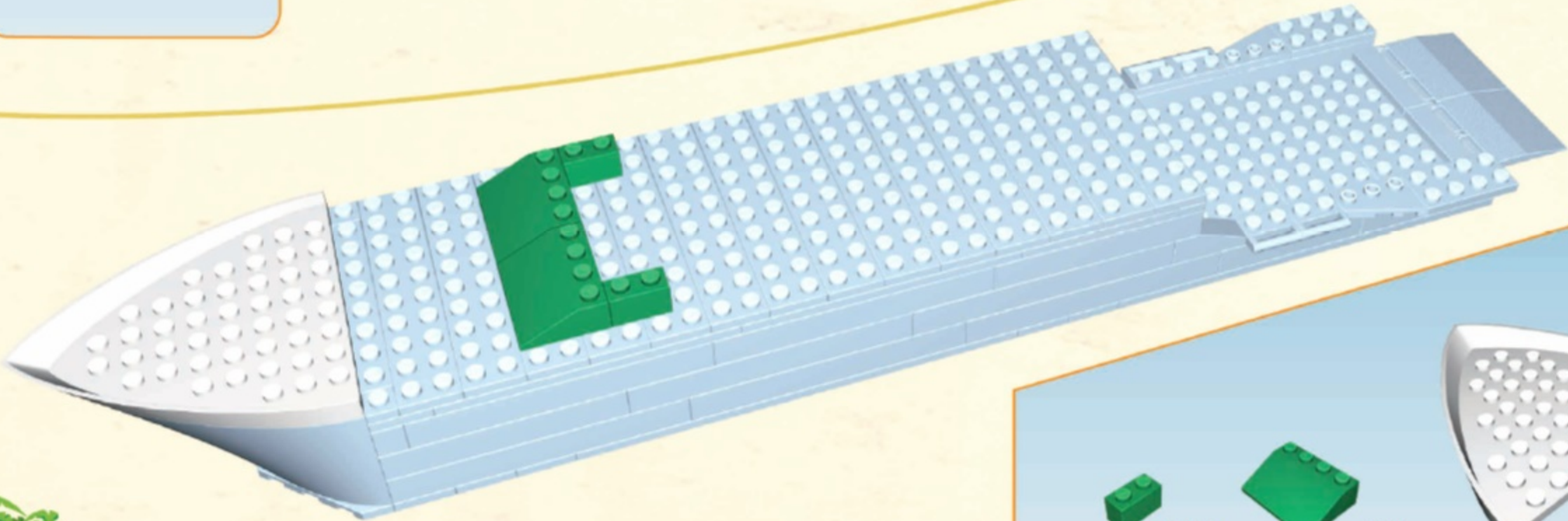
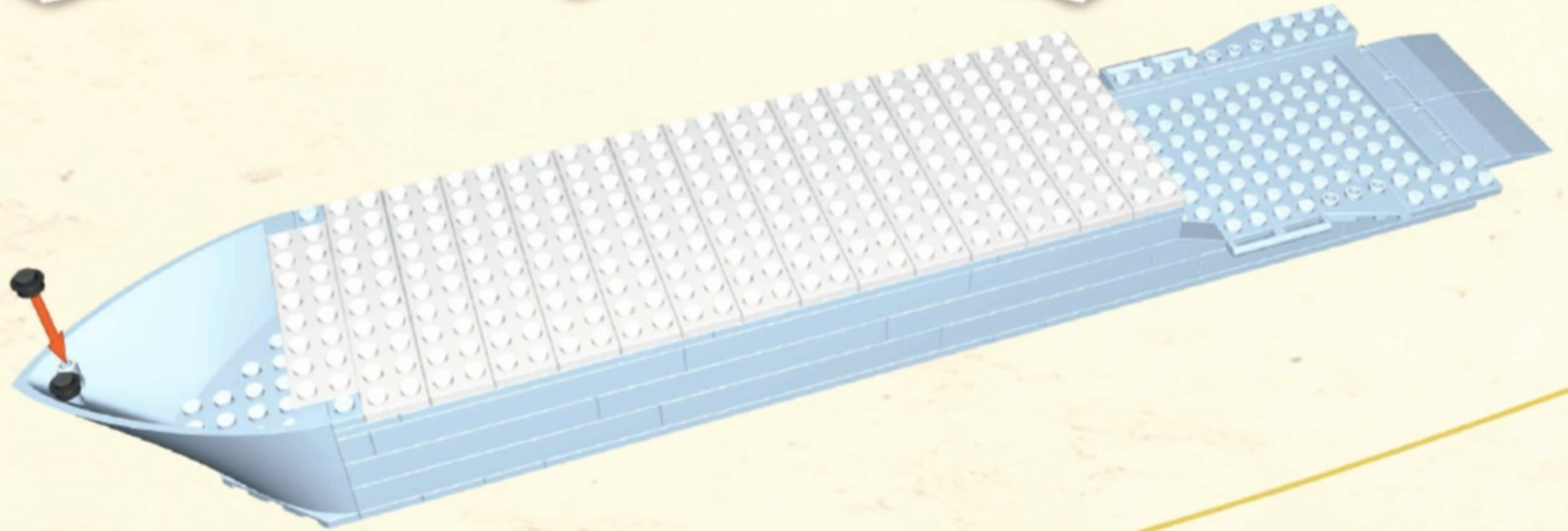

11

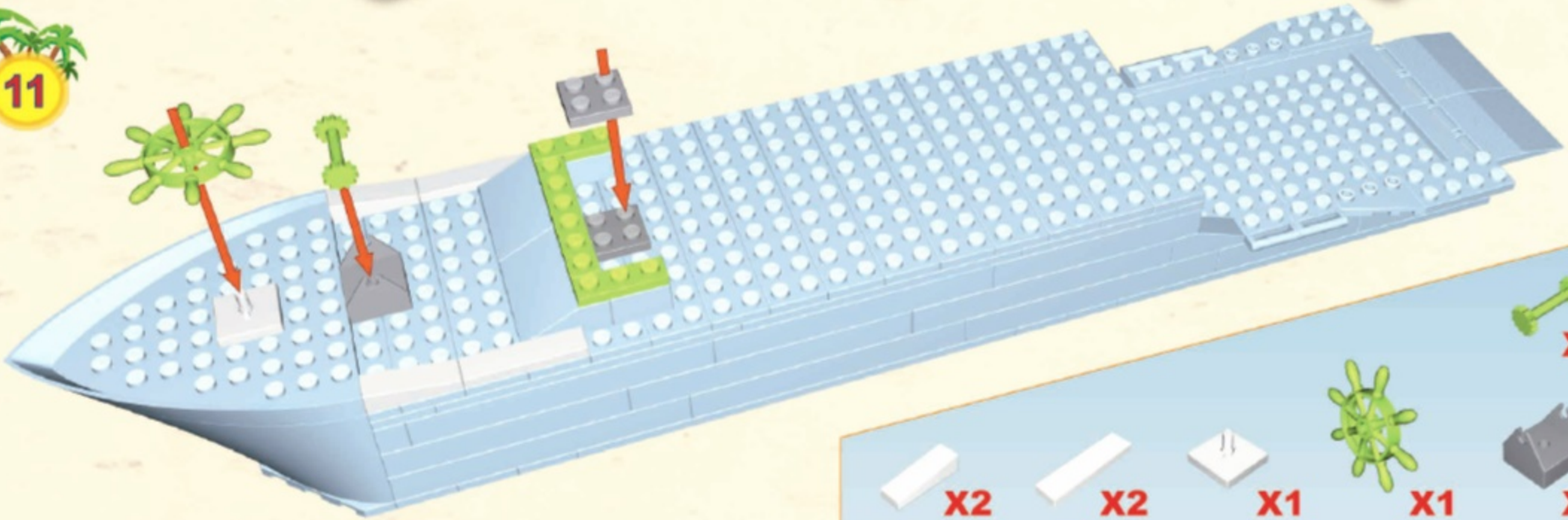

- X2
- X2
- X1
- X1
- X1
- X2
- X2
- X1
- X2
- X1
- X2

12

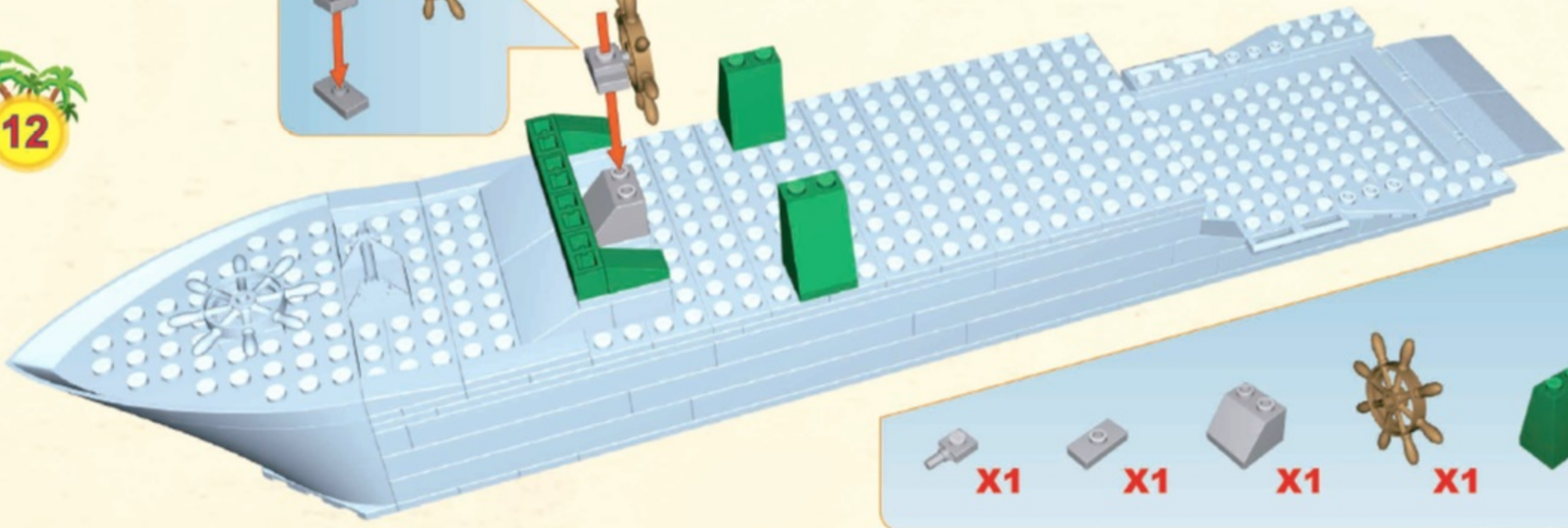
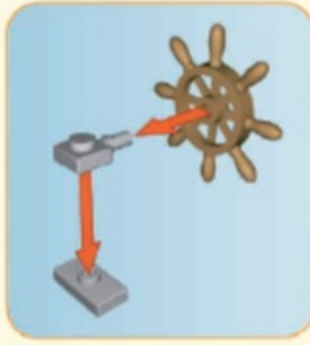

- X1
- X1
- X1
- X1
- X2
- X2
- X4
- X2



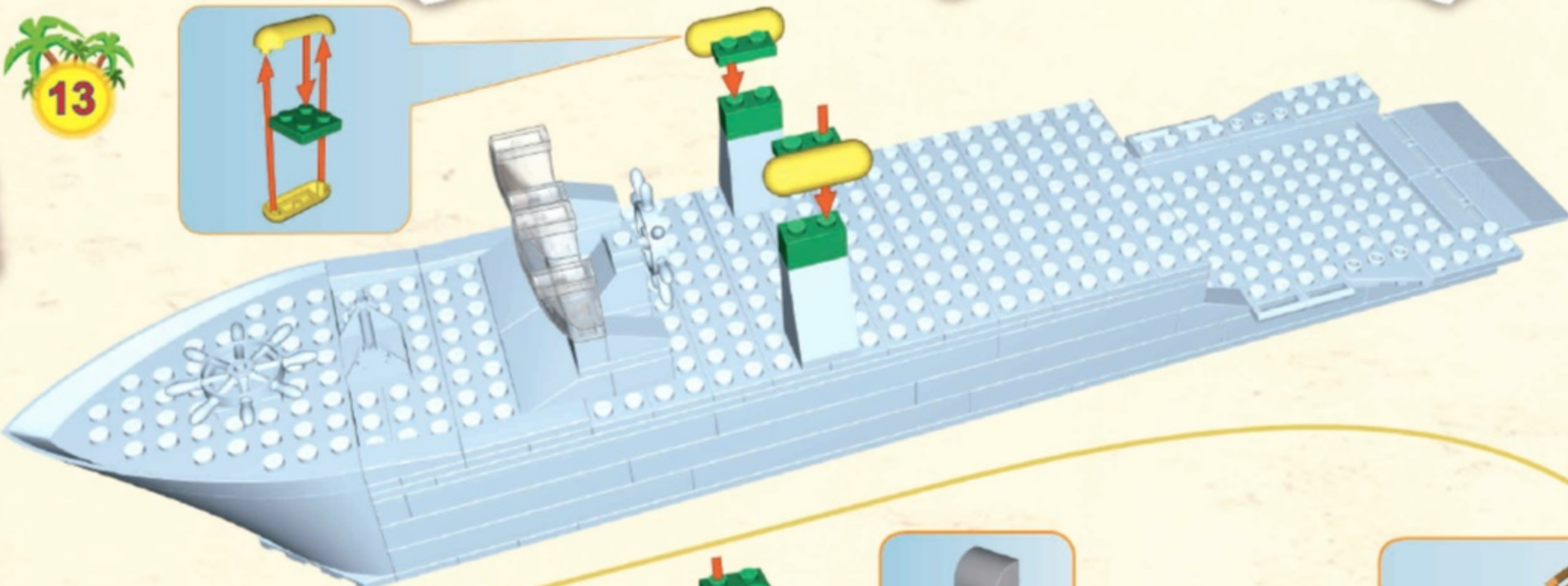



13

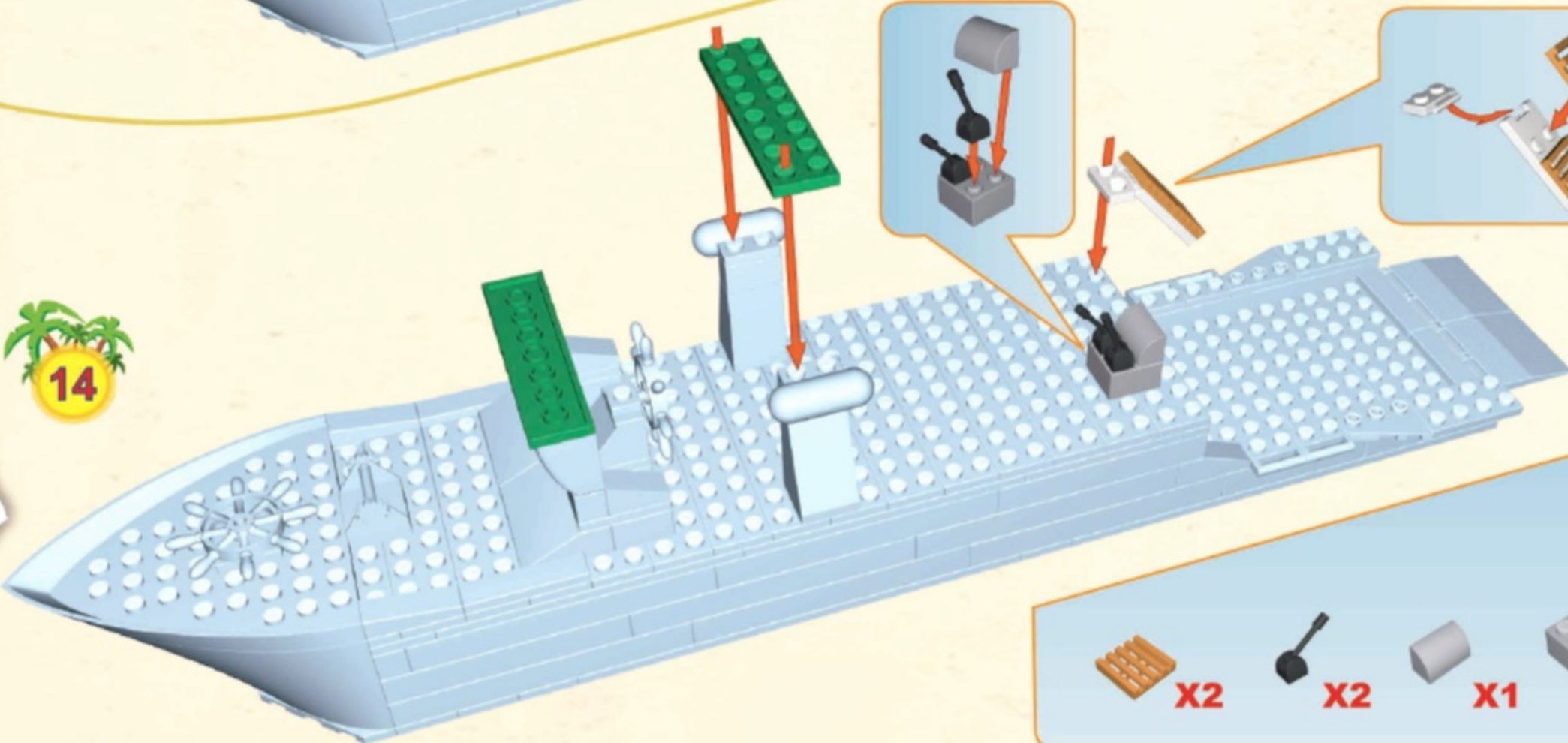

-  X2
-  X2
-  X2
-  X4

14



-  X2
-  X2
-  X1
-  X1
-  X2
-  X1
-  X1

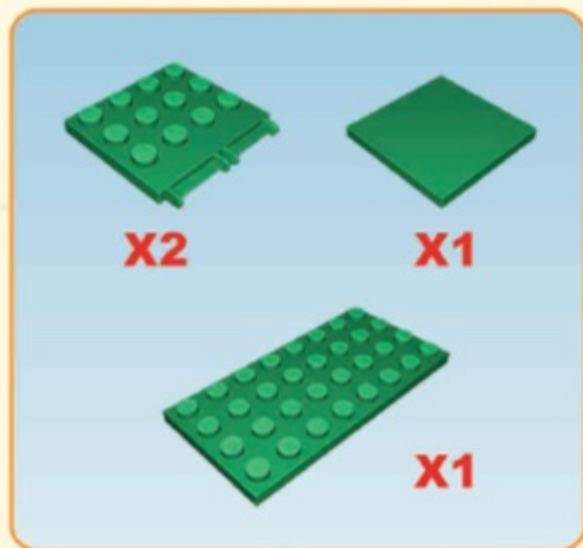
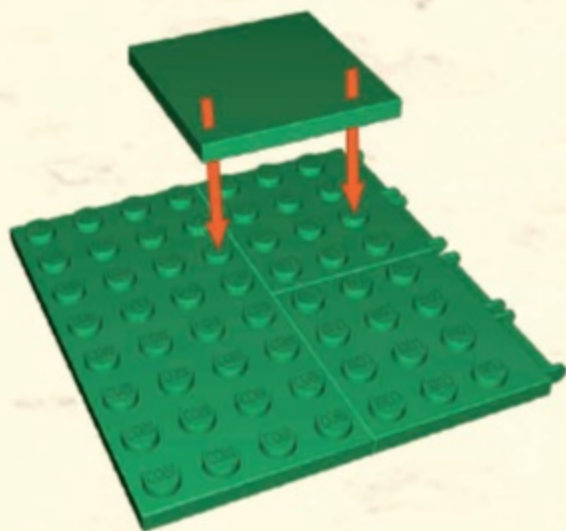

15



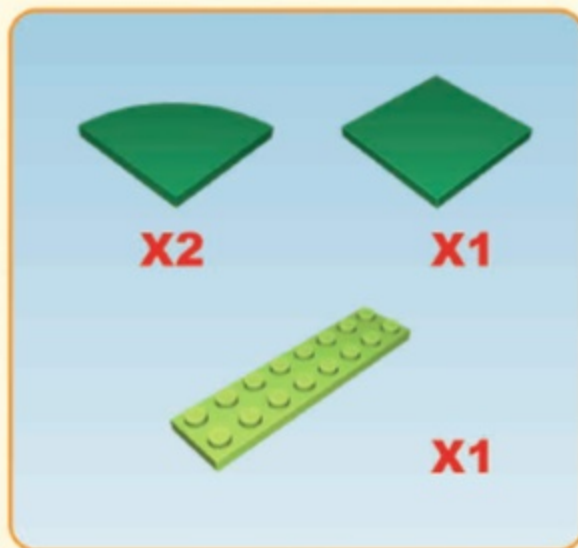
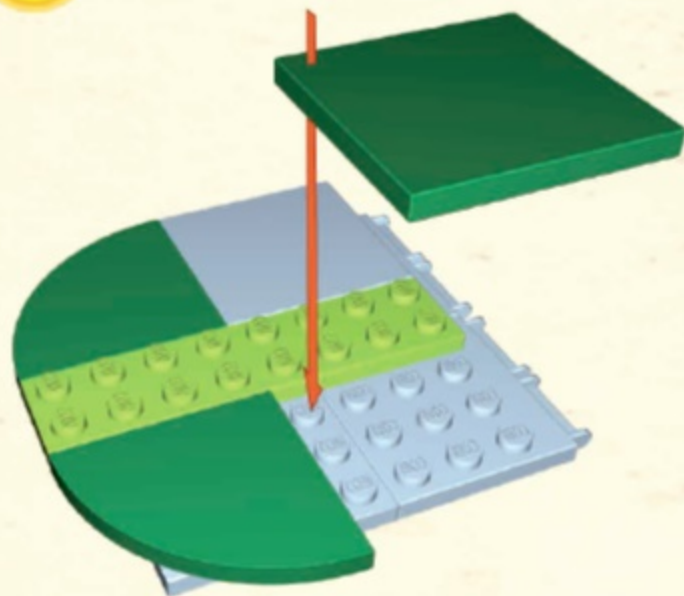

16

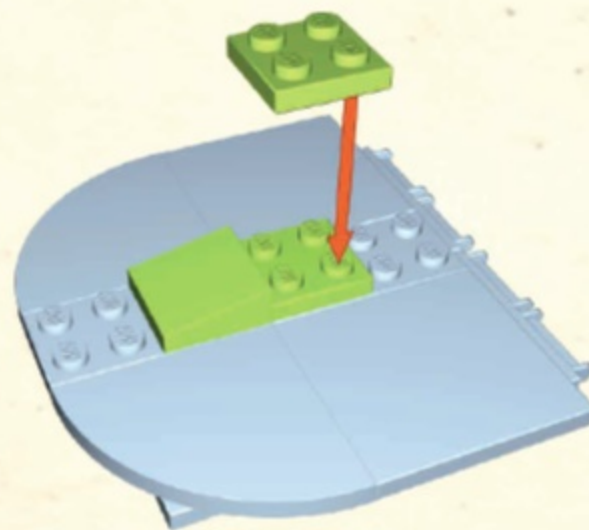

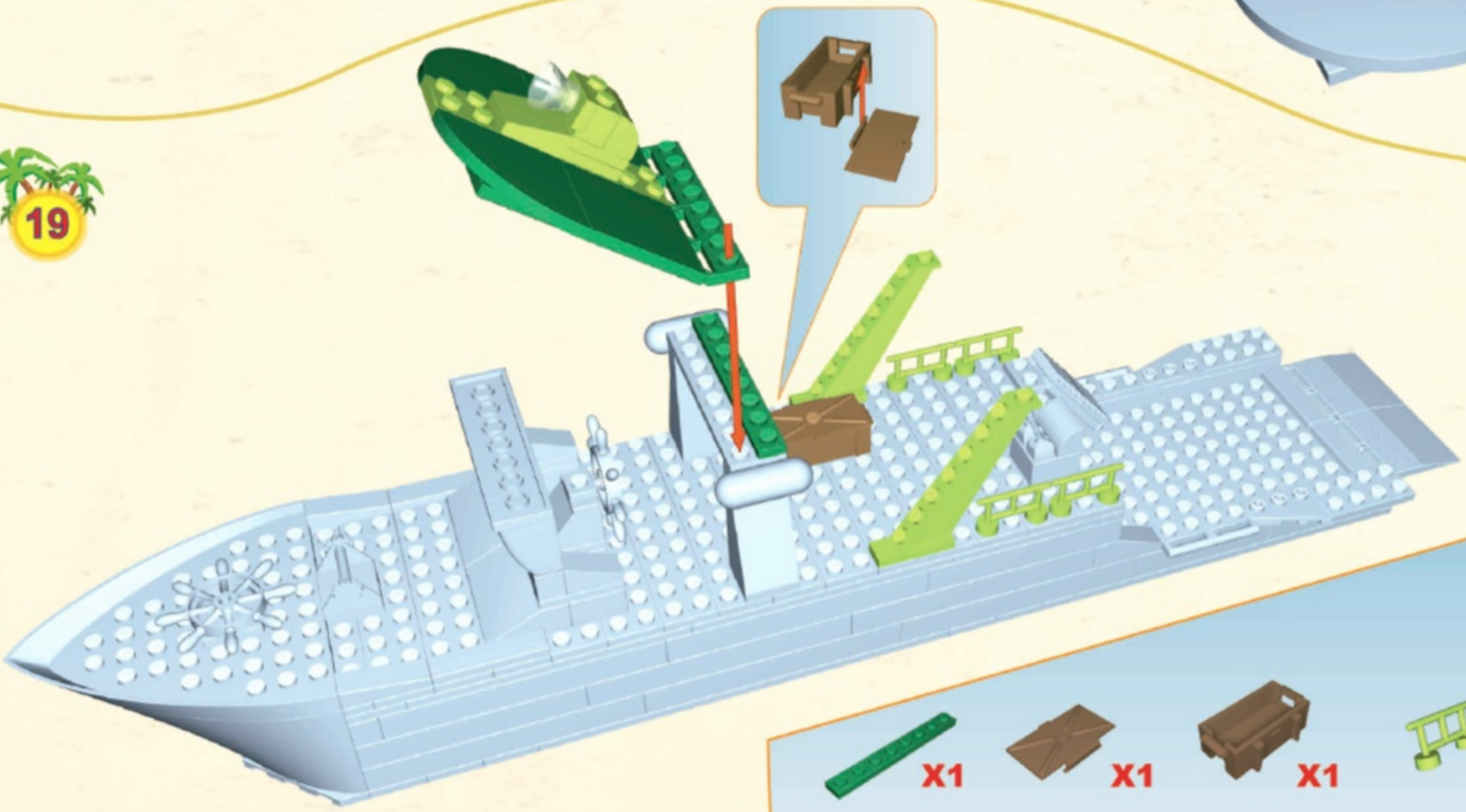
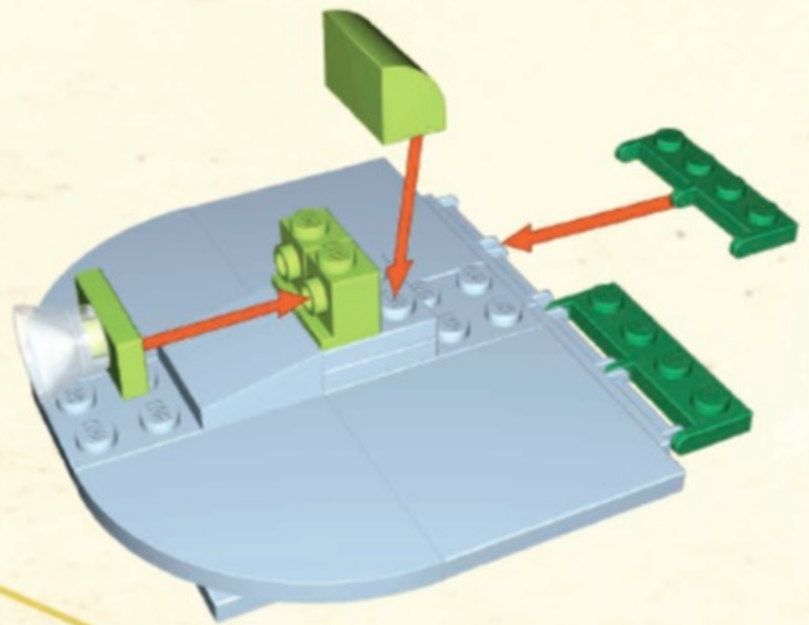

17



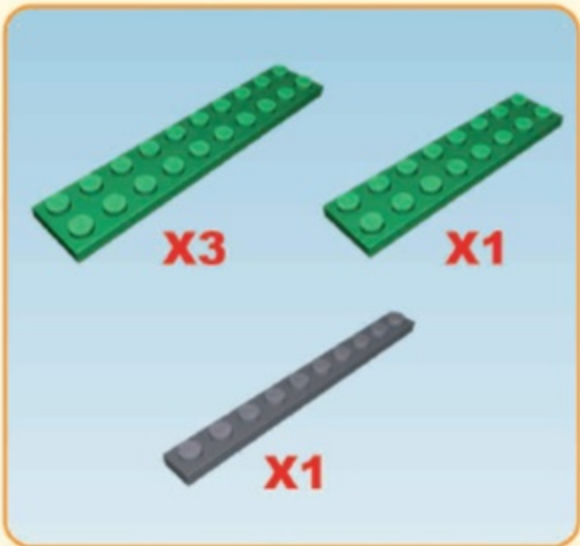
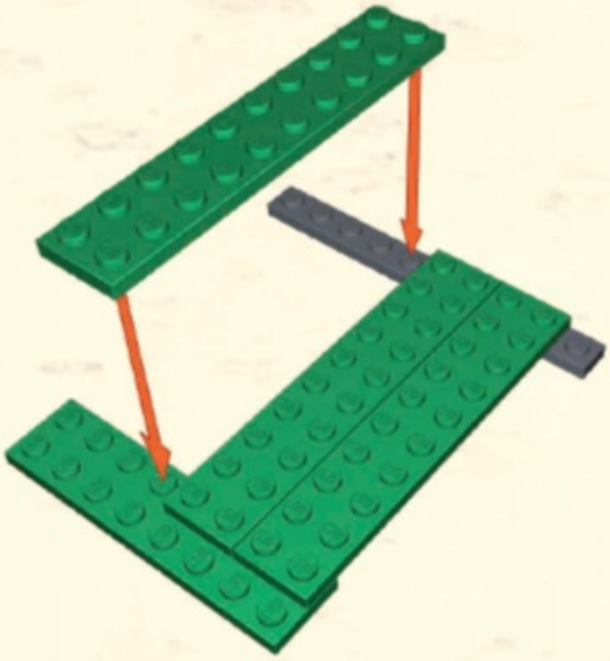

20



21

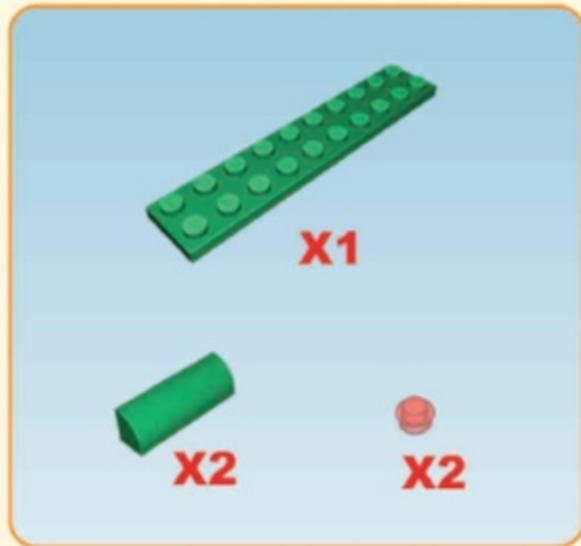
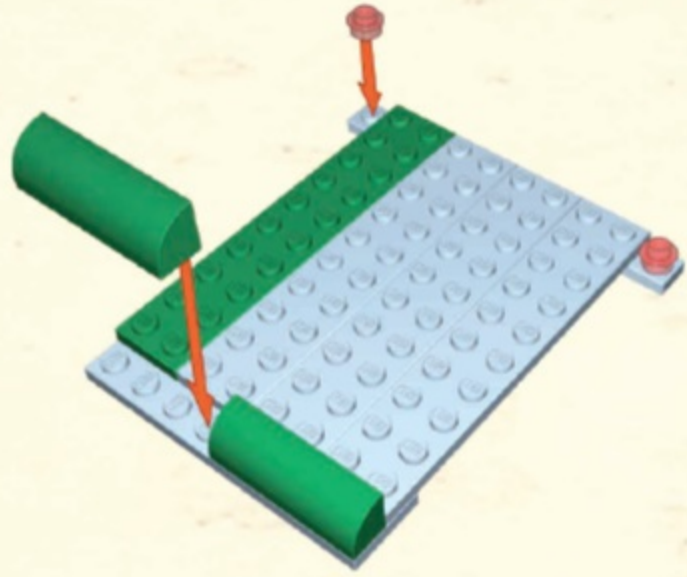



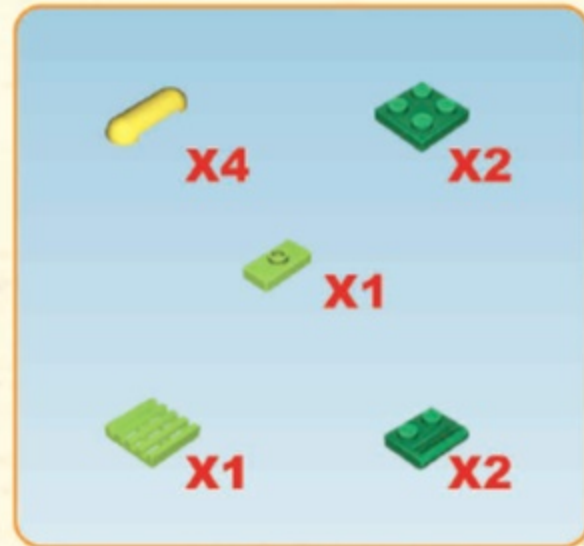
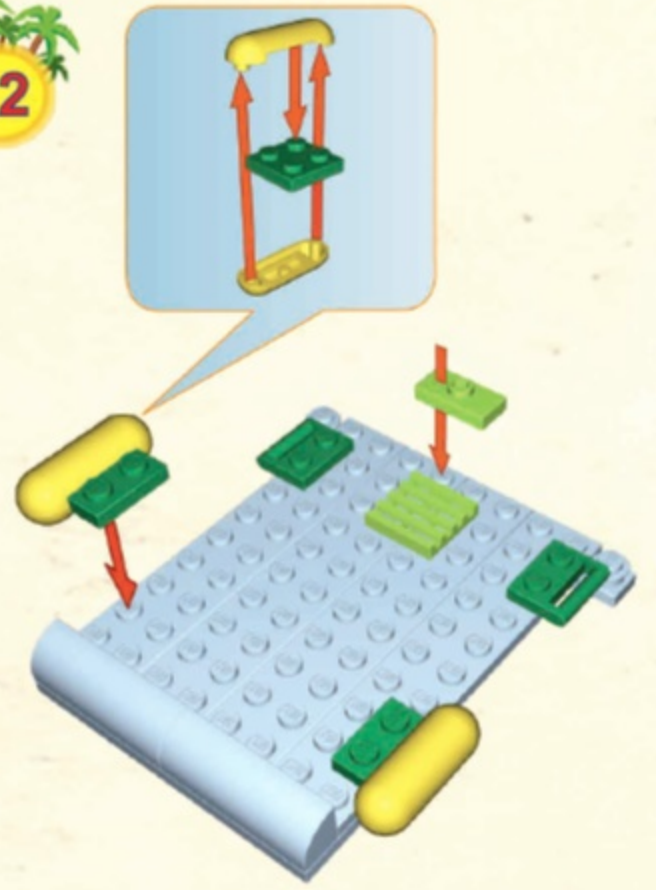

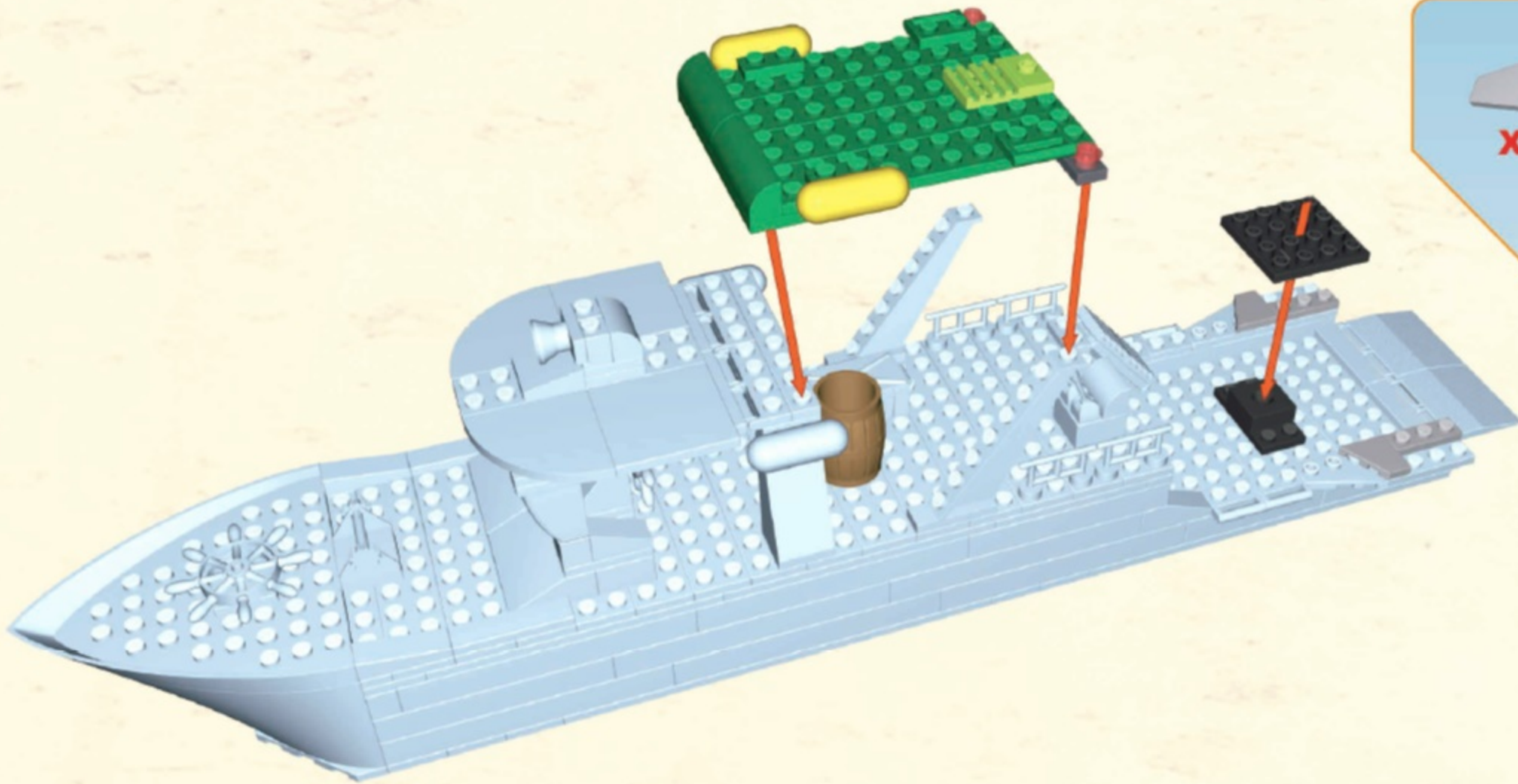



22





- X1
- X1
- X1
- X2
- X1
- X1

			
X1	X1	X1	X1
			
X2	X1	X1	X1

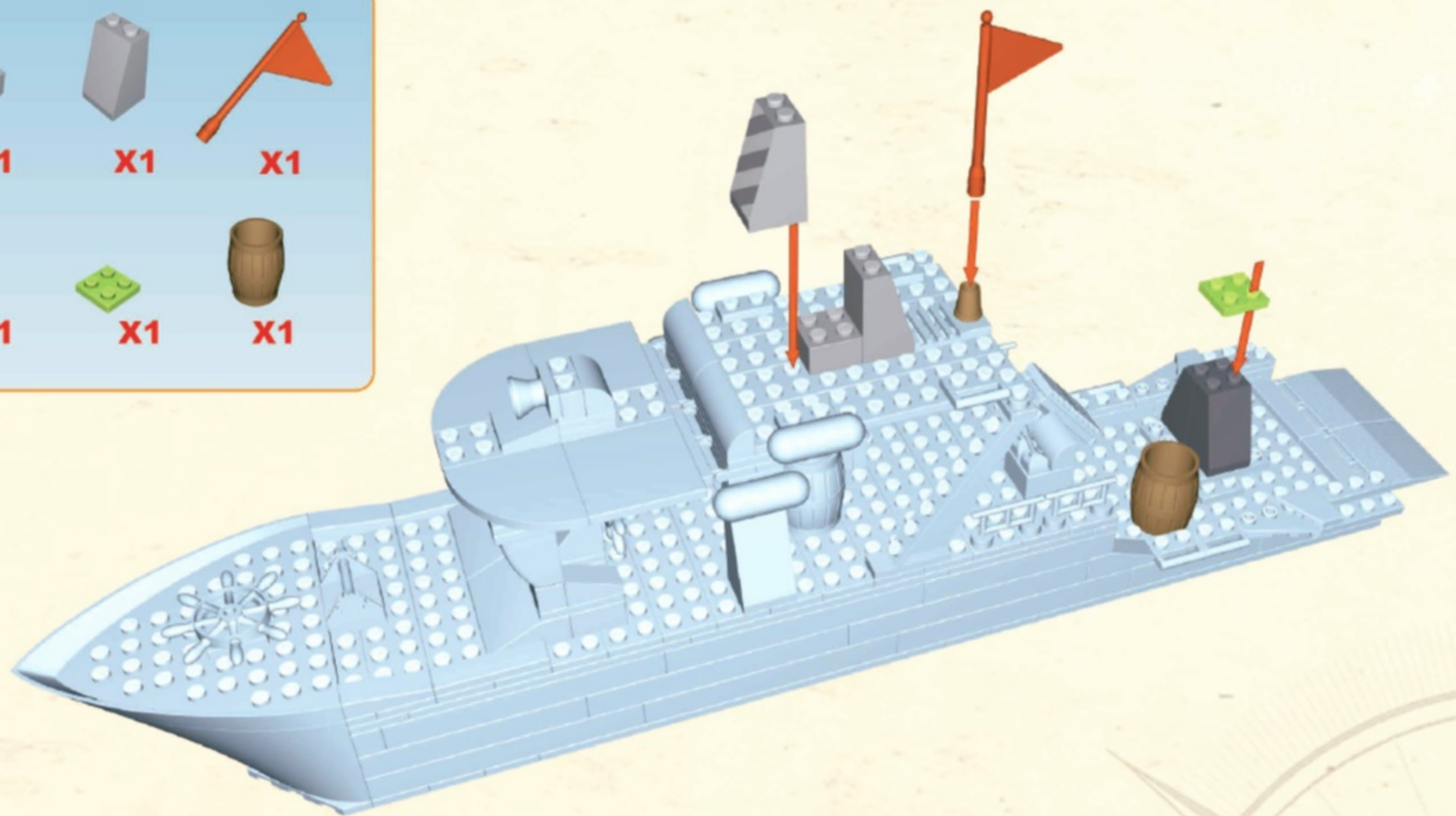



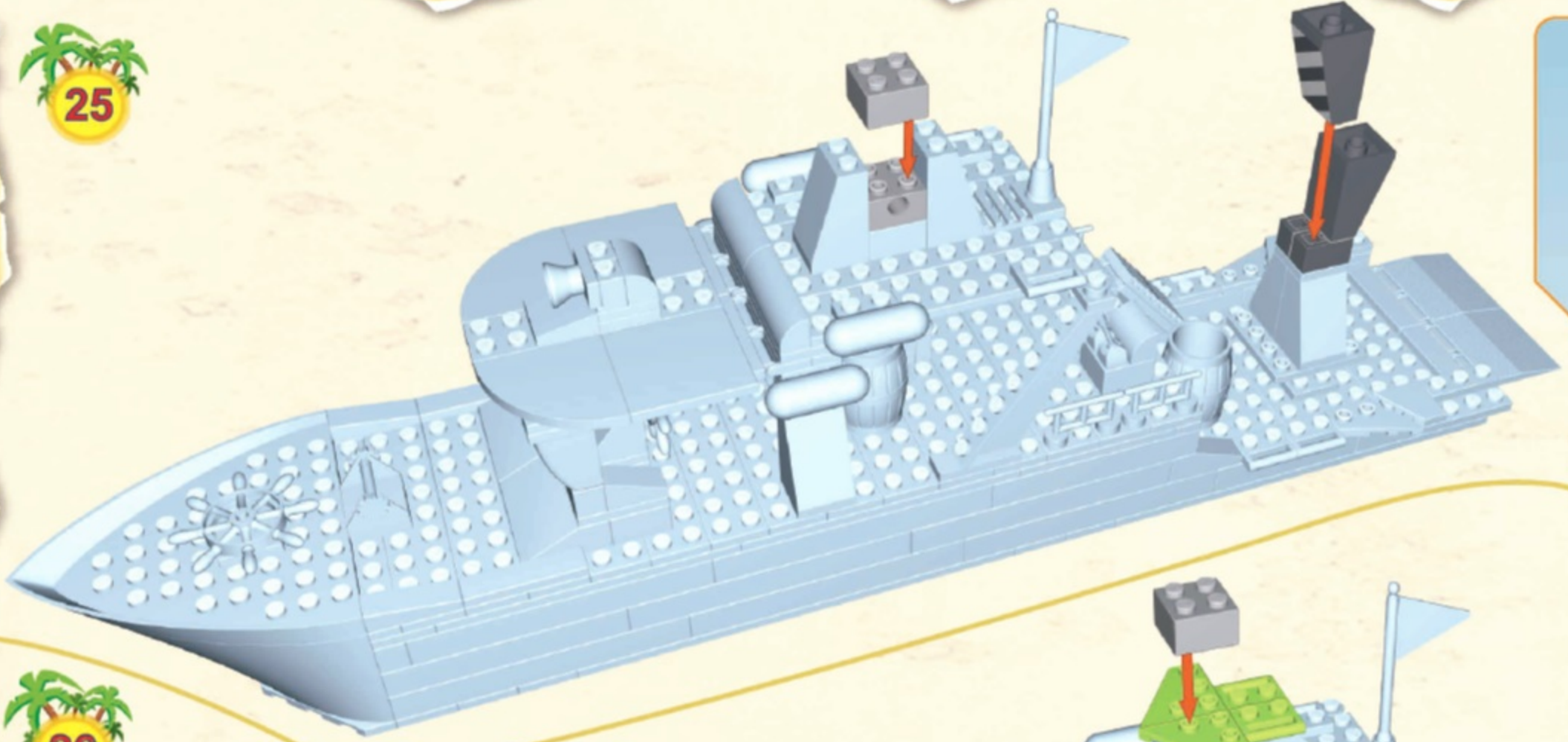



 25

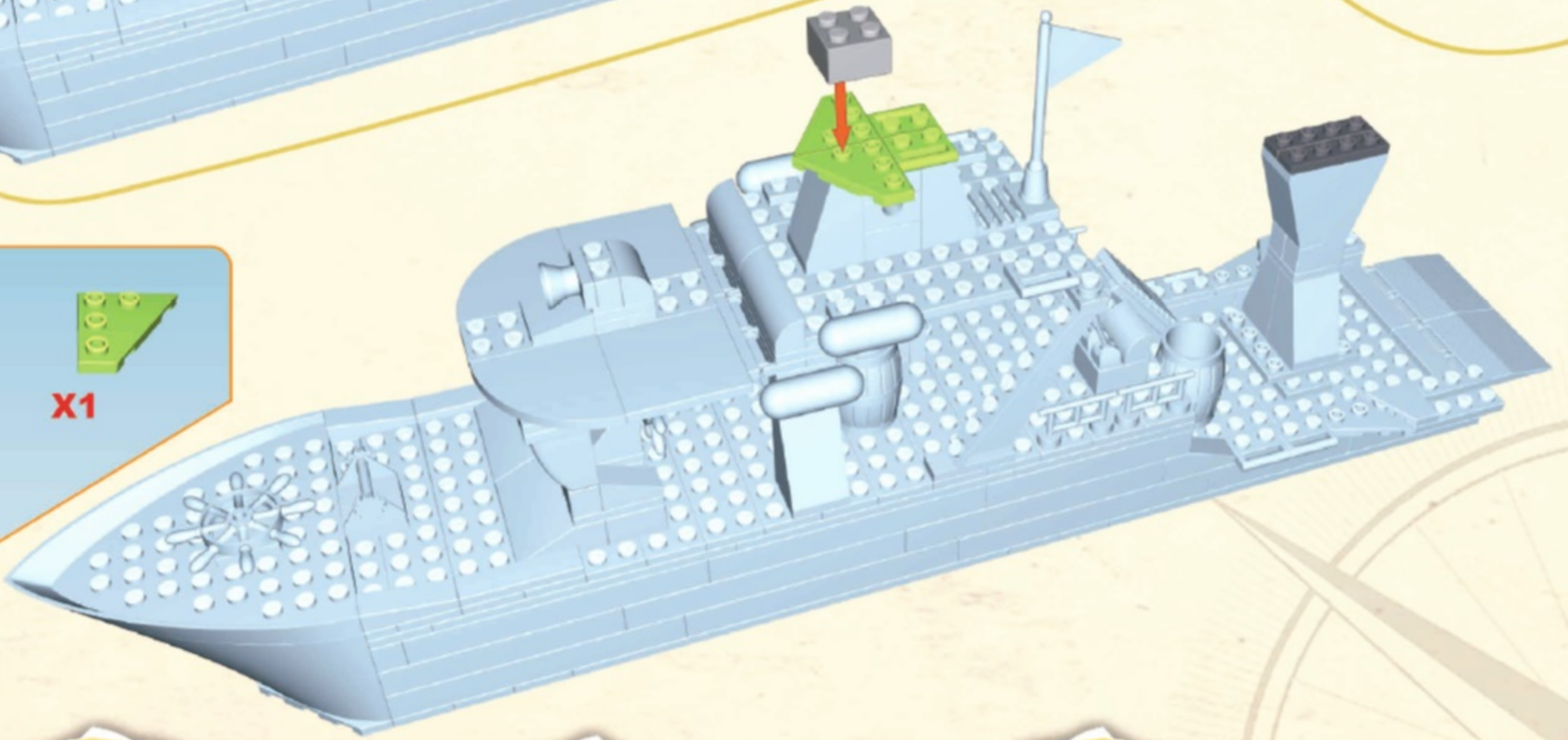

-  X1
-  X1
-  X2
-  X2



 26



-  X1
-  X1
-  X1
-  X2
-  X2

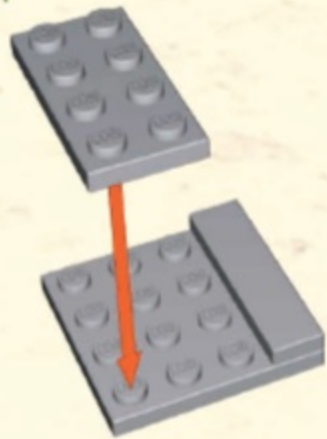

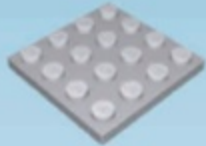

27



-  X1
-  X1
-  X1



28

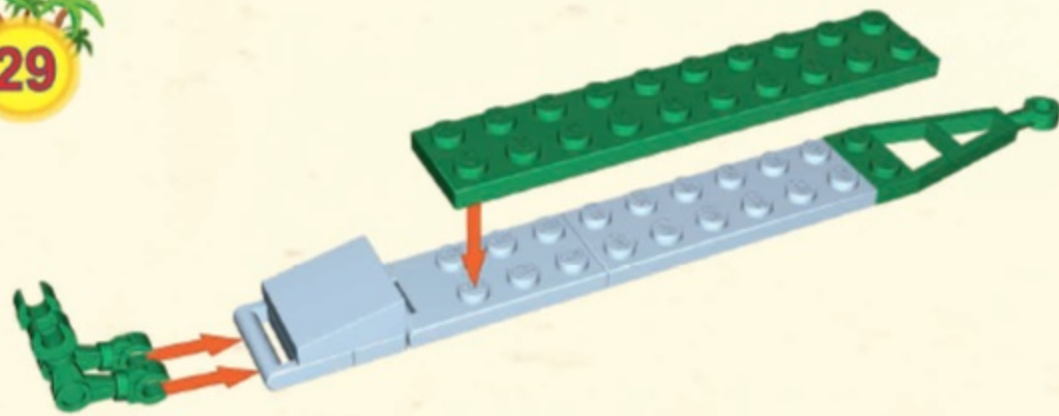

-  X1
-  X1
-  X1
-  X1
-  X1

29

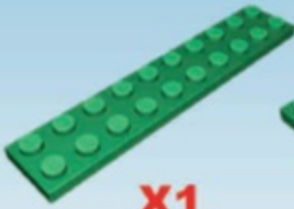

-  X2
-  X1
-  X1

30

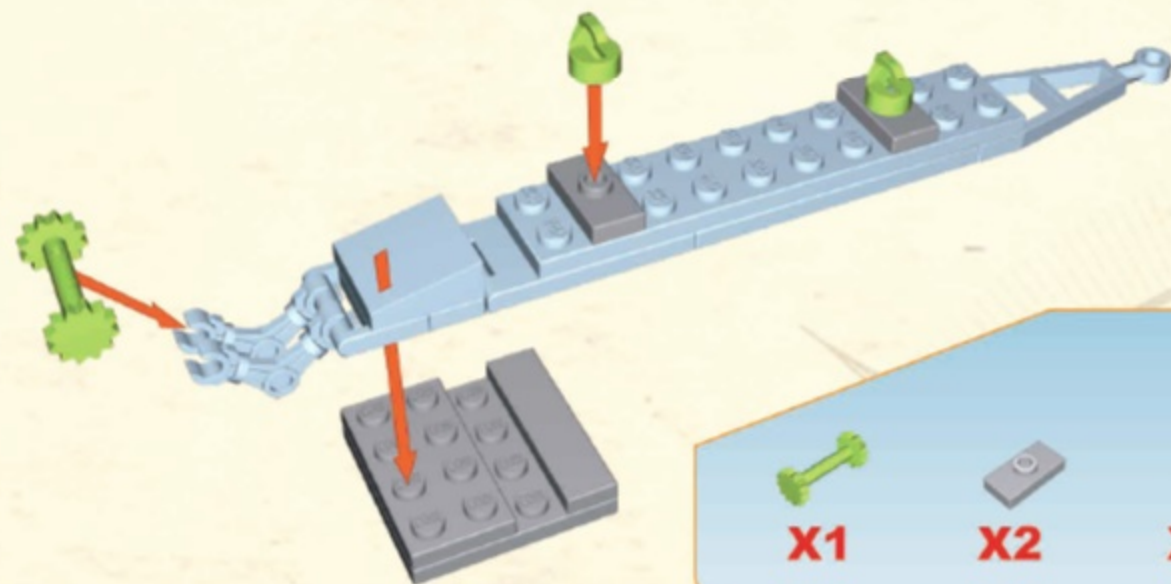

-  X1
-  X2
-  X2

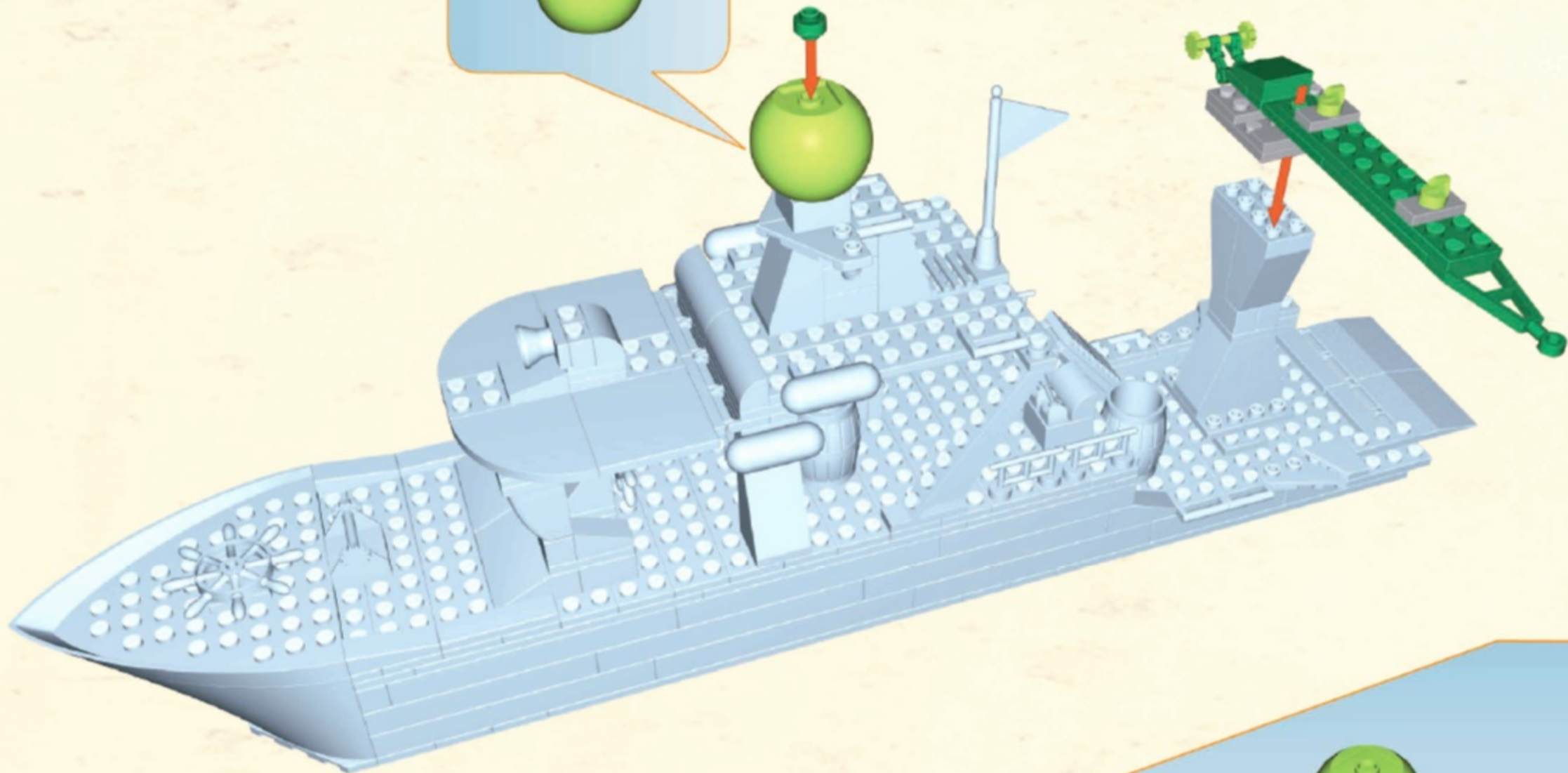
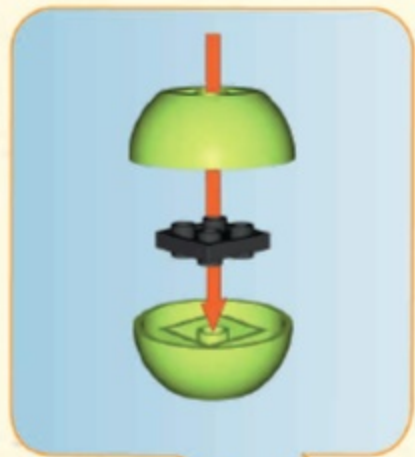

32

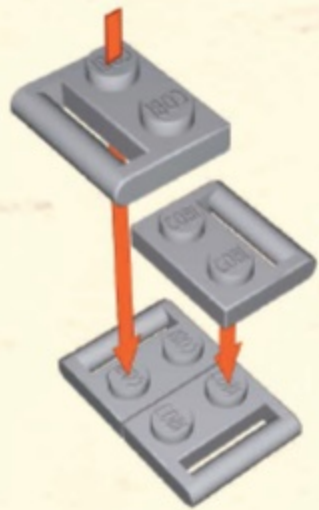

33

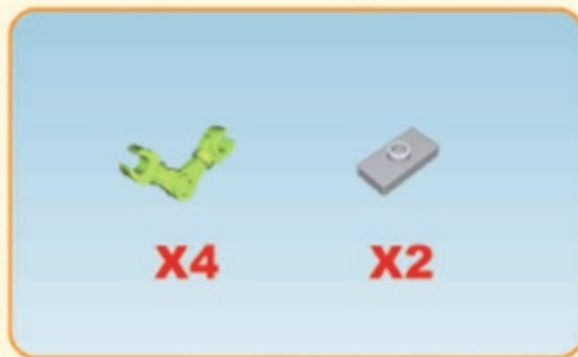
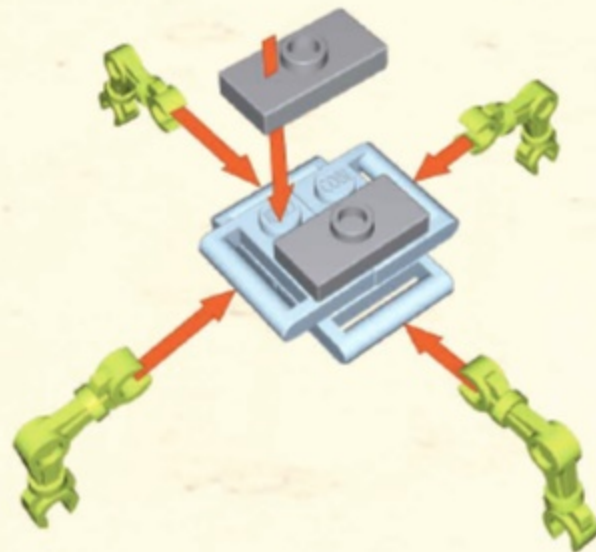

34

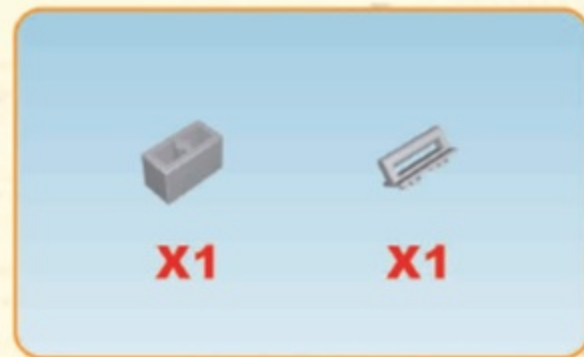
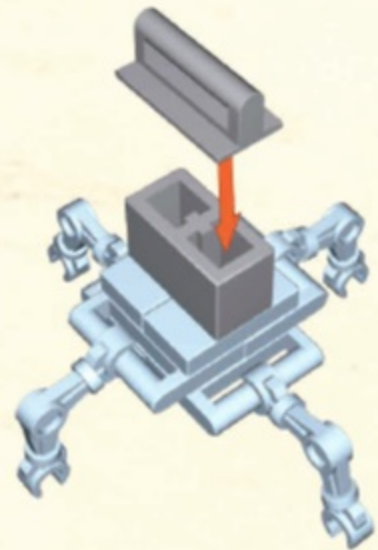

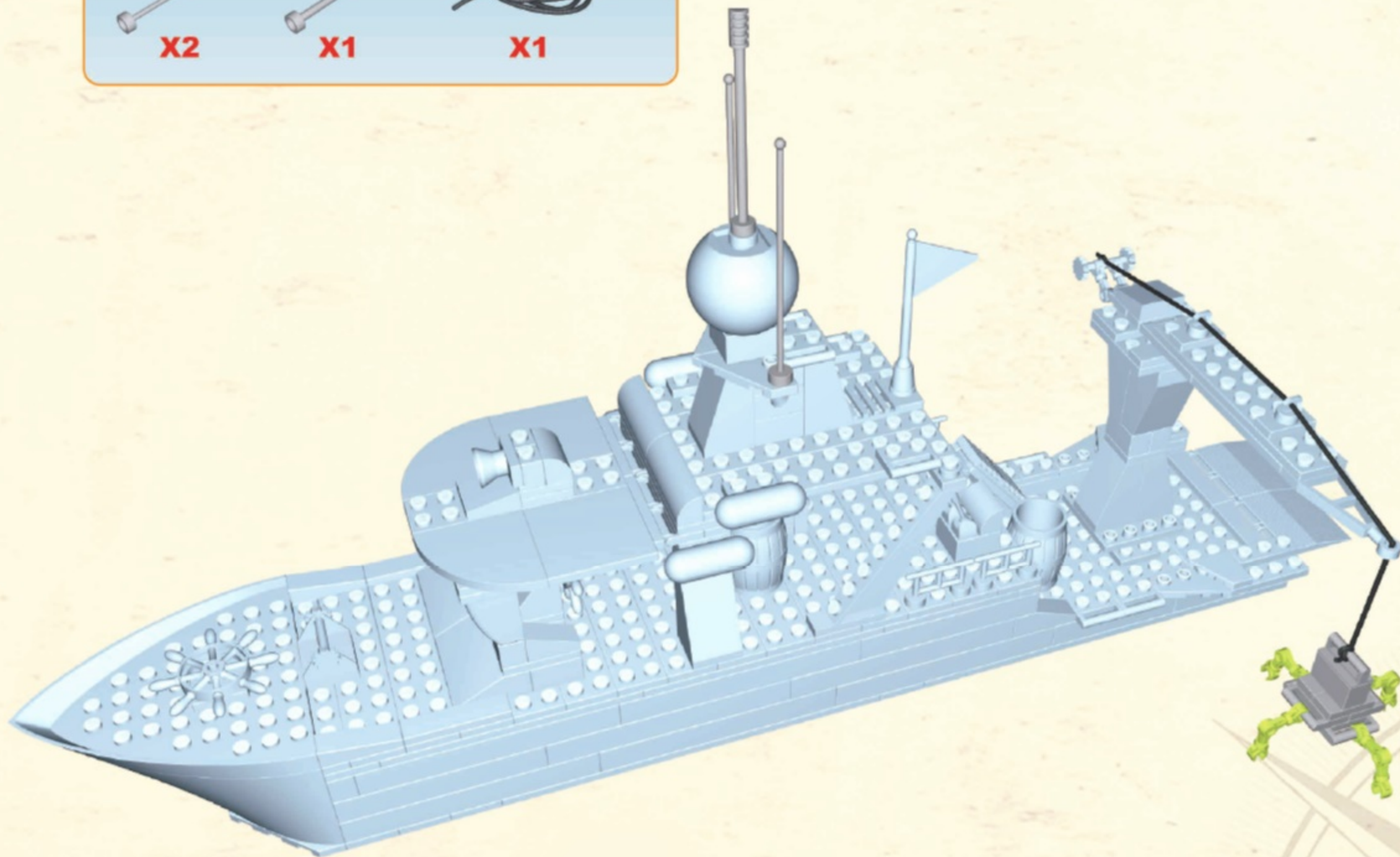
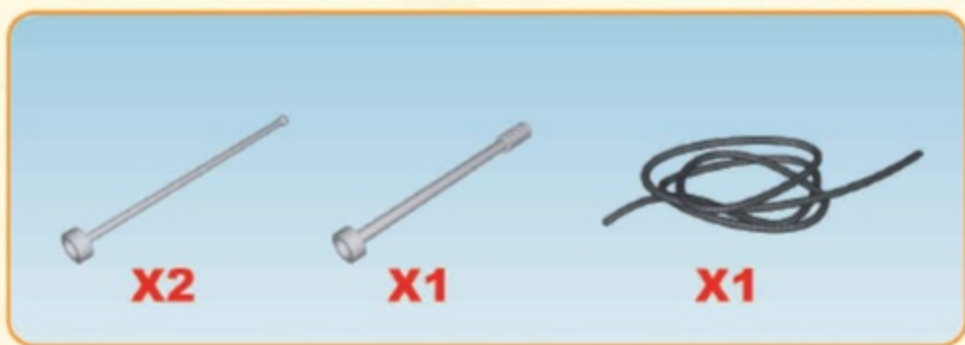

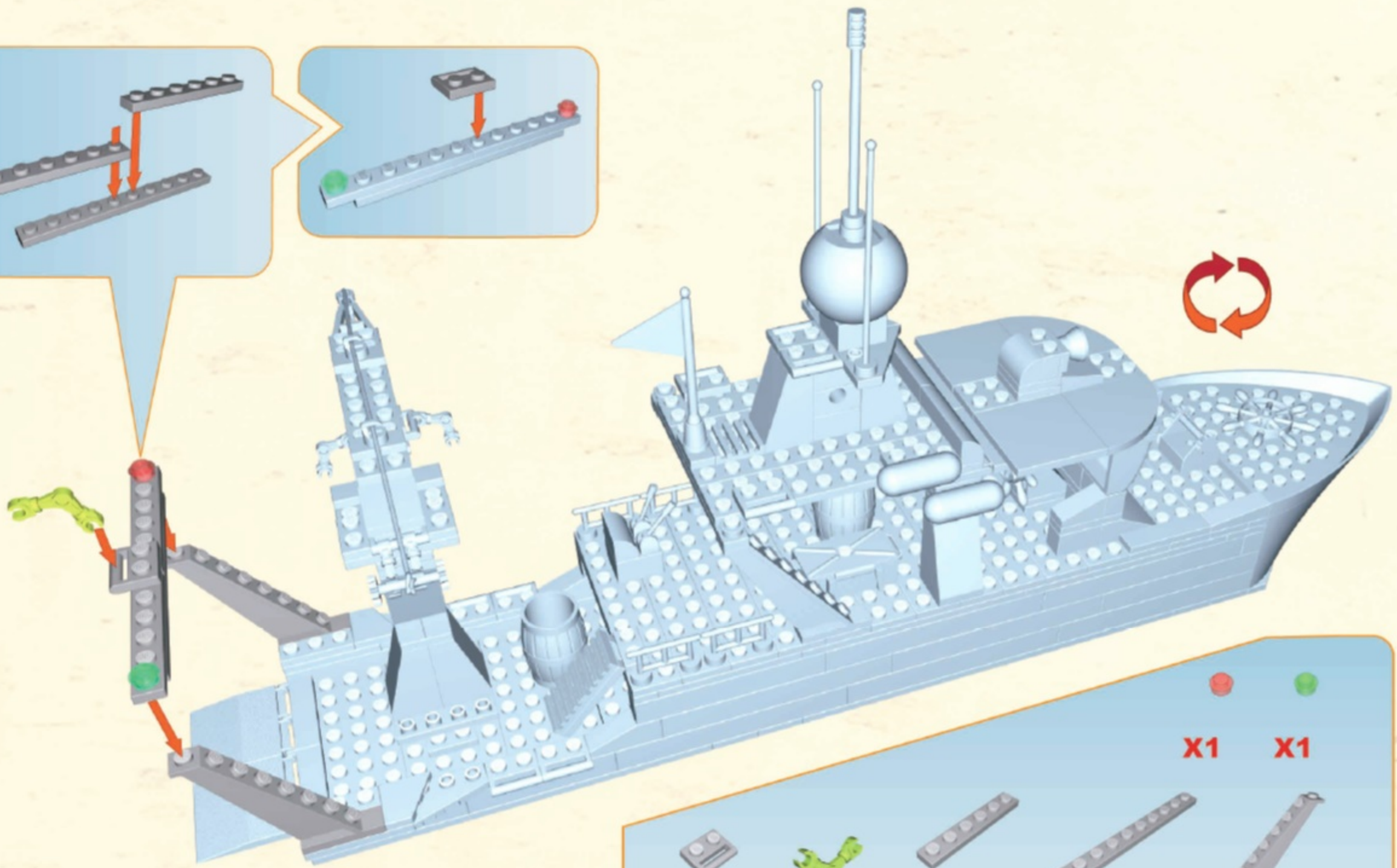
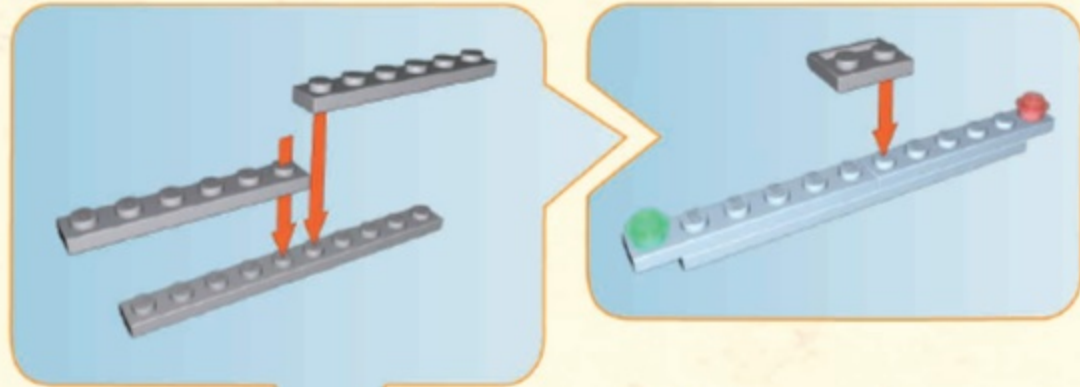

- X1 (grey 1x2 Technic plate)
- X1 (green Technic claw)
- X2 (grey 1x4 Technic beam)
- X1 (grey 1x6 Technic beam)
- X2 (grey 1x8 Technic beam)
- X1 (red Technic ball)
- X1 (green Technic ball)

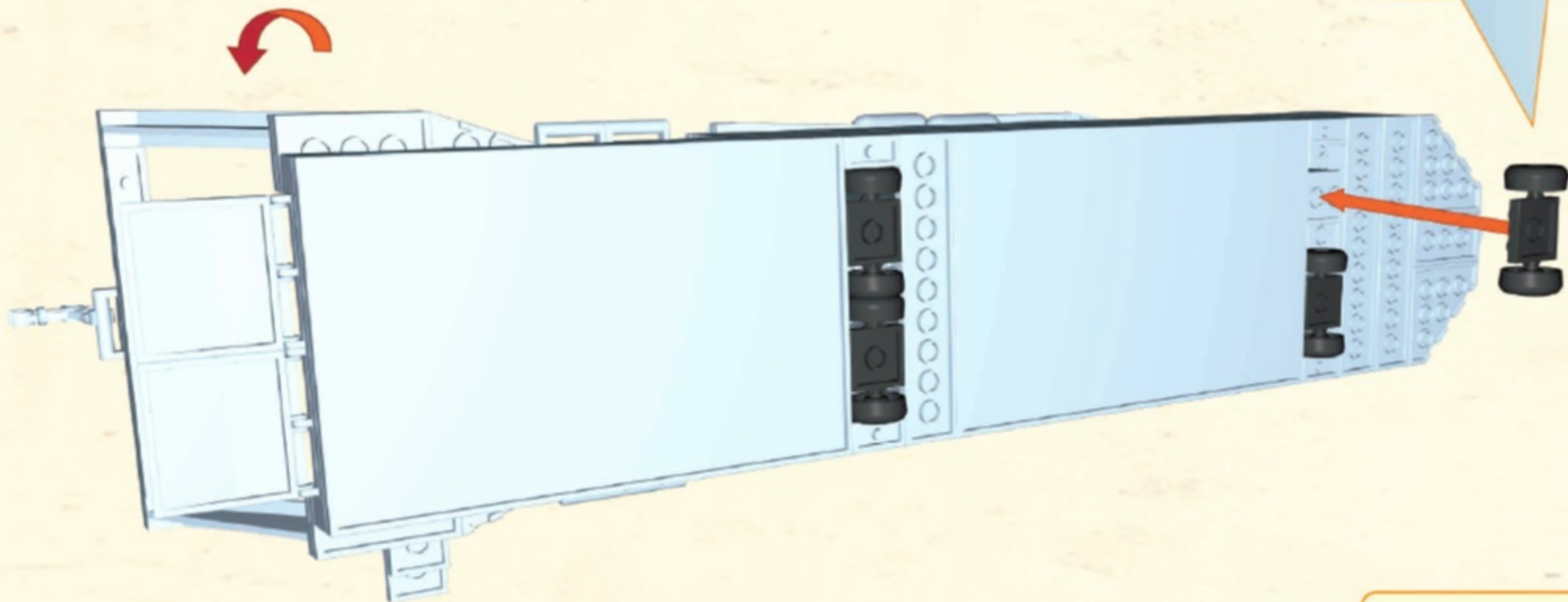
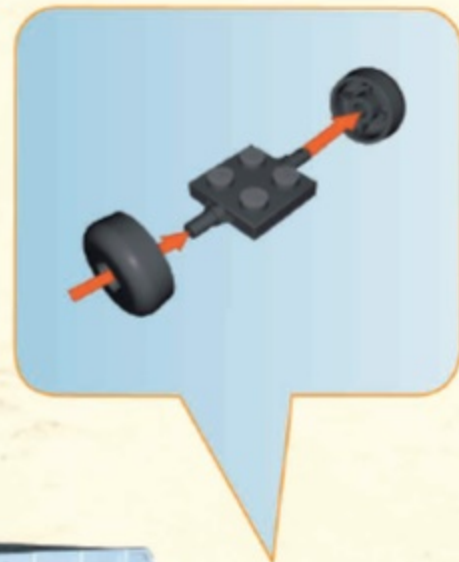

Printed in EU

08-22301-277

